



BERNINA 590

User manual

Table of Contents

IMPORTANT SAFETY INSTRUCTIONS	9	2.4 Spool pin	31
Important information	11	Retractable spool pin	31
1 My BERNINA	13	Horizontal spool pin	32
1.1 Introduction	13	2.5 Free arm	33
1.2 BERNINA Quality control	13	2.6 Feed dog	33
1.3 Welcome to the world of BERNINA	13	Adjusting the feed dog	33
1.4 Overview Machine	15	2.7 Slide-on table	34
Overview front controls	15	Using the slide-on table	34
Overview front	16	Using the edge guide	35
Overview sideways	17	2.8 Presser foot	35
Overview back	18	Adjusting the presser foot position via the knee lifter of the Free Hand System	35
1.5 Supplied accessories	19	Adjusting the presser foot position via the button «Presser foot up/down»	35
Overview accessories machine	19	Changing the presser foot	36
Use of the power cable (only USA/Canada)	20	Selecting the presser foot in the user interface	36
Overview presser feet	21	Adjusting the presser foot pressure	37
Accessory box	22	2.9 Instruction for adjusting the feed dog	37
1.6 Overview User Interface	22	2.10 Needle and stitch plate	37
Overview functions/Visual information	22	Changing the needle	37
Overview System settings	23	Selecting the needle in the User Interface	38
Overview selection menu sewing	24	Selecting the needle type and the needle size	38
Overview Icons	24	Adjusting the needle position up/down	38
1.7 Needle, Thread, Fabric	25	Adjusting the needle position left/right	38
Overview Needles	25	Needle stop up/down (permanent)	39
Example for needle description	26	Changing the stitch plate	39
Thread selection	27	Selecting the stitch plate in the User Interface	40
Needle/thread combination	27	2.11 Threading	40
2 Sewing preparation	28	Threading the upper thread	40
2.1 Accessory box	28	Threading the double needle	43
Removing and attaching the accessory box	28	Threading the Triple Needle	43
Storing accessories	28	Winding the bobbin thread	44
2.2 Connection and Switching on	29	Threading the bobbin thread	45
Connecting the foot control	29	Indicating fill level of bobbin thread	47
Connecting the machine	29	3 Setup Program	48
Attaching the knee lifter of the Free Hand System	29	3.1 Sewing settings	48
Fixing the touchscreen pen	30	Adjusting the upper thread tension	48
Switching the machine on	30	Adjusting the maximum sewing speed	48
2.3 Foot control	30	Programming securing stitches	48
Regulating the speed via the foot control	30	Adjusting the hovering height of the presser foot	49
Raising/Lowering the needle	31	Programming the button «Pattern end»	49
Programming the foot control individually	31	Programming the button «Thread cutter»	50
		Adjusting the presser foot position with needle stop down	51



Programming the button «Quick reverse»	51	5.2	BERNINA Dual Feed	70
Programming the foot control	52		Application of the BERNINA Dual Feed	71
3.2 Embroidery settings	53	5.3	Regulating the speed	72
Adjusting the upper thread tension	53	5.4	Adjusting the upper thread tension	72
Adjusting the maximum embroidering speed	53	5.5	Editing stitch patterns	73
Setting the embroidery motif position when opening ..	53		Changing the stitch width	73
Calibrating the hoop	54		Changing the stitch length	73
Entering the fabric thickness	54		Correcting the balance	73
Function thread away on/off	55		Programming pattern repeat	74
Programming securing stitches (Smart Secure)	55		Programming long stitch	74
Adjusting the thread cut	56		Mirror image of stitch patterns	74
Changing the measuring unit	57		Editing stitch pattern length	75
3.3 Selecting personal settings	58		Programming the stitch counter function	75
3.4 Monitoring functions	58		Sewing stitch patterns using the triple stitch	75
Activating the upper thread indicator	58		Quick reverse	76
Activating the bobbin thread indicator	59		Permanent Quick reverse	76
3.5 Activating the audio signals	59		Backstepping	76
3.6 Machine settings	60	5.6	Combining stitch patterns	76
Selecting a language	60		Overview Combi mode	76
Adjusting the brightness of the display	60		Creating Stitch pattern combinations	76
Adjusting the sewing light	60		Saving a stitch pattern combination	77
Checking the firmware version	61		Loading a stitch pattern combination	77
Reviewing the total number of stitches	61		Overwriting a stitch pattern combination	77
Registering details of the dealer	61		Deleting a stitch pattern combination	77
Saving Service data	62		Editing a single stitch pattern	78
Back to basic setting	63		Deleting a single stitch pattern	78
Deleting user data	63		Adding a single stitch pattern	79
Deleting motifs on the BERNINA USB Stick	64		Adapting the stitch pattern length and stitch pattern width	79
Calibrating the Buttonhole foot No. 3A	64		Mirroring a stitch pattern combination	80
Updating the machine Firmware	65		Stitch pattern combination Subdivider 1	80
Recovering saved data	65		Stitch pattern combination Subdivider 2	80
Cleaning the thread catcher	66		Securing a stitch pattern combination	81
Lubricating the machine	66		Programming pattern repeat	81
Packing the embroidery module	67	5.7	Administering stitch patterns	81
4 System settings	68		Saving settings of stitch patterns	81
4.1 Calling up the Tutorial	68		Saving stitch patterns in personal memory	82
4.2 Calling up the Creative Consultant	68		Overwriting stitch patterns from the personal memory ..	82
4.3 Using eco mode	68		Loading stitch patterns from the personal memory	82
4.4 Calling up the embroidery consultant	68		Deleting stitch patterns from the personal memory	82
4.5 Calling up the Help	69		Saving stitch patterns on the BERNINA USB stick	83
4.6 Cancelling any alterations with «clr»	69		Uploading a stitch pattern from the BERNINA USB stick	83
5 Creative sewing	70	5.8	Securing	84
5.1 Overview selection menu sewing	70		Securing via the icon «Securing»	84
Selecting a stitch pattern	70		Securing with the button «Pattern end»	84

5.9	Height Compensation of uneven layers	84	8.3	Altering font size	109
5.10	Sewing Corners	85	9	Buttonholes	110
6	Practical stitches	86	9.1	Overview Buttonholes	110
6.1	Overview Practical stitches	86	9.2	Making use of the height compensation tool	112
6.2	Sewing straight stitch	88	9.3	Using the compensation plate	112
6.3	Securing with the automatic Securing Program	89	9.4	Marking buttonholes	113
6.4	Sewing in the zipper	89	9.5	Cord	114
6.5	Sewing both sides of the zipper from bottom to top	90		Using cord with the Buttonhole foot with slide No. 3A ..	114
6.6	Sewing triple straight stitch	91		Using cord with the Buttonhole foot No. 3C (optional accessory)	115
6.7	Sewing Triple zig zag	92	9.6	Sewing a test sample	116
6.8	Manual darning	92	9.7	Determining the buttonhole slit width	116
6.9	Automatic darning	94	9.8	Determining the buttonhole length with the Buttonhole foot with slide No. 3A	117
6.10	Reinforced darning, automatic	95	9.9	Determining the buttonhole length with Buttonhole foot No. 3C (optional accessory)	117
6.11	Reinforced Darning Program	95	9.10	Sewing a buttonhole automatically	118
6.12	Finishing edges	96	9.11	Programming the Heirloom buttonhole	119
6.13	Sewing Double overlock	96	9.12	Sewing the manual 7-step buttonhole with the Buttonhole foot No. 3C (optional accessory)	119
6.14	Narrow edgestitching	97	9.13	Sewing the manual 5-step buttonhole with the Buttonhole foot No. 3C (optional accessory)	120
6.15	Wide edgestitching	97	9.14	Cutting the buttonhole open with the seam ripper ..	121
6.16	Edgestitching using the seam guide (optional accessory)	98	9.15	Cutting open buttonholes with the buttonhole cutter (optional accessory)	121
6.17	Sewing hem edges	98	9.16	Sewing on buttons	121
6.18	Sewing blind hems	99	9.17	Sewing eyelets	122
6.19	Sewing visible hems	100	10	Quilting	123
6.20	Sewing flat joining seams	100	10.1	Overview Quilt Stitches	123
6.21	Sewing basting stitches	101	10.2	Quilting, Securing Program	124
7	Decorative stitches	102	10.3	Sewing handlook quilt stitches	124
7.1	Overview Decorative Stitches	102	10.4	Guiding the quilt work freely	125
7.2	Bobbin-Play	103	11	BERNINA Stitch Regulator (BSR)	126
7.3	Altering the stitch density	104	11.1	BSR mode 1	126
7.4	Sewing cross stitches	104	11.2	BSR mode 2	126
7.5	Pintucks	105	11.3	BSR function with Straight stitch No. 1	126
	Pintucks	105	11.4	BSR function with Zig zag No. 2	126
	Overview pintucks	105	11.5	Sewing preparations for quilting	126
	Inserting the cord	106		Attach the BSR presser foot	126
	Sewing Pintucks	106		Changing the presser foot sole	127
8	Alphabets	107			
8.1	Overview Alphabet	107			
8.2	Creating lettering	108			



Grouping embroidery motifs	159	16.3 Adjusting the upper thread tension	175
15.6 Pinpoint placement	160	16.4 Embroidering via the foot control	175
Positioning of grid points	160	17 Appendix	176
Free point positioning	161	17.1 Maintenance and cleaning	176
15.7 Combining embroidery motifs	161	Cleaning the display	176
Combining embroidery motifs	161	Cleaning the feed dog	176
Deleting a single embroidery motif	162	Cleaning the hook	176
Duplicating a combination	162	Lubricating the hook	177
15.8 Creating lettering	163	17.2 Troubleshooting	179
Overview embroidery alphabets	163	17.3 Error messages	181
Creating words/sentences	163	17.4 Storage and disposal	186
Editing words/sentences	164	Storing the machine	186
15.9 Changing the colors of the embroidery motif	165	Dispose of the machine	186
Overview changing the color	165	17.5 Technical data	186
Changing the colors	165	18 Overview stitch patterns	187
Altering the colors via the color wheel	166	18.1 Overview Stitch patterns	187
Changing the thread brand	167	Practical stitches	187
15.10 Embroidering the embroidery motif	167	Buttonholes	187
Overview Embroidery menu	167	Decorative stitches	187
Adding basting stitches	167	18.2 Overview Embroidery motifs	193
Moving the hoop	168	Editing embroidery motifs	193
Embroidery sequence control when thread breaks	168	Projects	193
Cutting connecting stitches	168	Quilt motifs	194
Reducing color changes	169	Ornaments	203
Multi-colored embroidery motif on/off	169	Children	210
Endless Embroidery	169	Frames and borders	216
Color indication	170	Seasons	218
15.11 Free arm embroidering	170	Borders and Lace	224
15.12 Administering embroidery motifs	171	Sports and hobby	229
Administering embroidery motifs	171	Animals	233
Saving embroidery motifs in the personal memory	171	Flowers	234
Saving the embroidery motif on the BERNINA USB stick	172	Designs with special effects	239
Overwriting the embroidery motif in the personal memory	172	Index	244
Overwriting the embroidery motif on the BERNINA USB stick	172		
Importing stitch patterns	172		
Loading an embroidery motif from the personal memory	173		
Loading an embroidery motif from the BERNINA USB stick	173		
Deleting an embroidery motif from the personal memory	173		
Deleting an embroidery motif from the BERNINA USB stick	173		
16 Embroidery	174		
16.1 Embroidering via the button «Start/Stop»	174		
16.2 Increasing the embroidery speed	174		



IMPORTANT SAFETY INSTRUCTIONS

Please be aware of the following basic safety instructions when using your machine. Before using this machine, read instruction manual carefully.

DANGER!

To reduce the risk of electrical shock:

- Never leave the machine unattended as long as it is plugged in.
- Always unplug the machine from the electrical outlet immediately after using.

Protection against LED radiation:

- Do not view the LED light directly with optical instruments (e.g. magnifier). The LED light corresponds with protection class 1M.
- When the LED light is damaged or defective, contact your BERNINA specialist dealer.

WARNING

To reduce the risk of burns, fire, electric shock or injury to persons:

- To operate the machine always use the supplied power cable. USA and Canada only: Do not connect power plug NEMA 1-15 to circuits exceeding 150 volt-to-ground.
- Use this machine only for purposes as described in this manual.
- Only use the machine in dry rooms.
- Do not use the machine in a damp condition or in a damp environment.
- Do not use this machine as a toy. Close attention is necessary when this machine is used by or near children.
- The machine can be used by children older than 8 or by people with reduced physical, sensory or mental capabilities or if there is a lack of experience and knowledge how to operate the machine as long as they are supervised or have been given instruction concerning the responsible use of the appliance and are aware of the involved risks.
- Children are not allowed to play with this machine.
- Cleaning and maintenance work must not be carried out by children unless they are supervised.
- Never operate this machine if it has a damaged cord or plug, if it is not working properly, if it has been dropped or damaged, or dropped into water. Contact the nearest authorized BERNINA dealer to arrange further details.

- Only use accessory recommended by the manufacturer.
- Don't use this machine when the ventilation openings are blocked. Keep the ventilation openings and the foot control free from the accumulation of lint, dust and loose cloth.
- Never insert any objects into any openings of the machine.
- Do not place any objects on the foot control.
- Always use the machine with a foot control of this type LV-1.
- Do not operate the machine where aerosol products (sprays) or oxygen are being used.
- Keep fingers away from all moving parts. Special care is required around the needle.
- Neither pull nor push the fabric while sewing. This can cause needle breakage.
- When making any adjustments in the needle area – such as such as threading the needle, changing the needle, threading the hook or changing the presser foot – turn power switch to «0».
- Do not use bent needles.
- Always use the original BERNINA stitch plate. The wrong stitch plate can cause needle breakage.
- To disconnect, turn power switch to «0» and then remove the plug from the outlet. Do not unplug by pulling the cord, instead grasp the plug to pull it from the outlet.
- Always disconnect the power plug from the electrical outlet when the covers are removed or opened, when the machine is lubricated or during any other maintenance adjustments mentioned in the instruction manual.
- This machine is provided with double insulation (except USA, Canada and Japan). Use only identical replacement parts. See instructions for Servicing of double-insulated products.
- The sound pressure level is lower than 70 dB(A) under normal conditions.



Important information

Availability of the instruction manual

The instruction manual is supplied with the machine.

- Keep the instruction manual safe at a suitable place near the machine to have it at hand in case that you need to look up something.
- If you pass the machine to a third party, always include the instruction manual.

Proper use

Your BERNINA machine is conceived and designed for private household use. It is intended for sewing fabrics and other materials as described in this instruction manual. Any other use is not considered proper. BERNINA assumes no liability concerning consequences resulting from an improper use.

Equipment and scope of delivery

Example images are used in these operating instructions for the purposes of illustration. The machines shown in the images and the accessories shown therefore do not always match the actual items included with your machine. The supplied accessory can vary depending on the country of delivery. Accessories mentioned or shown which are not included in the scope of delivery can be purchased as special accessories from a BERNINA specialist dealer. Further accessories can be found at <https://www.bernina.com>.

For technical reasons and in order to improve the product, changes may be made to the equipment of the machine and the scope of delivery at any time and without prior notice.

Maintenance of double-insulated products

In a double-insulated product, two systems of insulation are provided instead of grounding. No grounding means is provided on a double-insulated product nor should a means for grounding be added to the product. Servicing a double-insulated product requires extreme care and knowledge of the system and should only be done by qualified service personnel. Only original spare parts should be used for service and repairs. A double-insulated product is marked with the words: «Double-Insulation »or «double-insulated».

 The symbol may also be marked on the product.

Environmental Protection

BERNINA is committed to the protection of the environment. We strive to minimize the environmental impact of our products by continuously improving product design and our technology of manufacturing.



The machine is labeled with the symbol of the crossed-out wastebin. This means that the machine must not be disposed of with the household waste when the machine is no longer needed. Improper disposal can result in dangerous substances getting into the groundwater and thus into our food chain, damaging our health.

The machine must be returned free of charge to a nearby collection point for waste electrical and electronic equipment or to a collection point for the reuse of the machine. Information on the collection points can be obtained from your local administration. When purchasing a new machine, the dealer is obliged to take back the old machine free of charge and dispose of it properly.

If the machine contains personal data, you are responsible for deleting the data yourself before returning the machine.

Explanation of symbols



Designates a high-risk hazard which can lead to serious injuries or potentially even death if not avoided.



Designates a medium-risk hazard which can lead to serious injuries if not avoided.



Designates a low-risk hazard which can lead to minor or moderate injuries if not avoided.



Designates a hazard which can lead to material damage if not avoided.



Tips from BERNINA **sewing experts** are found next to this symbol.



1 My BERNINA

1.1 Introduction

With your BERNINA 590 you can sew, embroider and quilt. Delicate silk or satin fabrics as well as heavy-weight linen, fleece and denim can be sewn without any problems with this machine. Numerous practical as well as decorative stitches, buttonholes and embroidery motifs are at your disposal.

Additional to this instruction manual, subsequently listed help programs are provided which will give you useful advice and support at any time how to operate your BERNINA 590.

The **Tutorial** gives information and explanations, covering various aspects of sewing, embroidering and the different stitches.

The **Creative Consultant** informs you about decision support for sewing projects. After entering the kind of fabric and the desired sewing project, suggestions concerning the suitable needle or the appropriate presser foot are displayed.

The **Embroidery Consultant** informs you about decision support for embroidery projects. After entering the kind of fabric and the desired embroidery project, suggestions concerning the suitable needle or the appropriate embroidery foot are displayed.

The **Help Program** contains information about individual stitch patterns, functions and applications in the display.

Further information

In addition to this instruction manual of your BERNINA 590 further information products are enclosed.

The latest version of your instruction manual as well as additional information in connection with the machine and accessories can be found on our website <http://www.bernina.com>

1.2 BERNINA Quality control

All BERNINA machines are assembled with utmost care and are subjected to an extensive functionality test. The integrated stitch counter therefore indicates that the machine has already sewn stitches, which were performed exclusively for test purposes and quality control. The subsequent thorough cleaning does not exclude the possibility that thread remnants may still be found in the machine.

1.3 Welcome to the world of BERNINA

Made to create this is the slogan of BERNINA. Not only with our machines do we support you in the implementation of your ideas. In addition to the offers listed below, we offer you lots of suggestions and instructions for your future projects as well as the opportunity to exchange ideas with other sewing, quilting and embroidery enthusiasts. I wish you lots of pleasure.

BERNINA YouTube Channel

On YouTube we offer a wide range of how-to videos and support concerning the most important functions of our machines. Detailed explanations are also provided as for the various presser feet, so that your projects will succeed completely.

<http://www.youtube.com/BerninaInternational>

Provided in the languages English and German.

inspiration – the sewing magazine

Are you looking for ideas and instructions for great projects? In that case the BERNINA magazine «inspiration» is exactly what you need. «inspiration» offers extraordinary sewing and embroidery ideas four times a year. From seasonal fashion trends to trendy accessories and practical tips to decorate your home in an original way.

<http://www.bernina.com/inspiration>

The magazine is available in the languages English, German, Dutch and French. Not available in all countries.

BERNINA Blog

Fancy instructions, free sewing patterns and embroidery motifs as well as many new ideas: all this you can find in the weekly blog by BERNINA. Our experts give valuable tips and explain step by step how you can achieve the desired result. In the community you can upload your own projects and exchange experiences and ideas with other sewing and embroidering enthusiasts.

<http://www.bernina.com/blog>

Provided in the languages English, German and Dutch.

BERNINA Social Media

Follow us on the social networking to learn more about events, thrilling projects as well as tips and tricks all about sewing, quilting and embroidering. We will keep you informed and we are looking forward to presenting you the one or the other highlight from the world of BERNINA.

<http://www.bernina.com/social-media>



1.4 Overview Machine

Overview front controls



- 1 Quick reverse
- 2 Thread cutter
- 3 Presser foot up/down
- 4 Start/Stop
- 5 Pattern end

- 6 Needle up/down
- 7 Upper multifunction knob
- 8 Lower multifunction knob
- 9 Needle left/right



Overview front



- | | | | |
|---|---|----|---------------------------------|
| 1 | Connection for embroidery module | 8 | Speed control |
| 2 | Bobbin cover | 9 | Thread take-up lever cover |
| 3 | Connection for accessory (optional accessory) | 10 | Thread take-up lever |
| 4 | Presser foot | 11 | Thread cutter |
| 5 | Needle threader | 12 | Fixing screw |
| 6 | Sewing light | 13 | Connection for slide-on table |
| 7 | Thread cutter | 14 | Connection for Free Hand System |

Overview sideways



- | | | | |
|---|------------------------|----|---------------------------------|
| 1 | Foot control connector | 7 | Retractable spool pin |
| 2 | Feed dog up/down | 8 | Air vents |
| 3 | PC-connection | 9 | Handwheel |
| 4 | USB connection | 10 | Power switch |
| 5 | Spool pin | 11 | Power cable connection |
| 6 | Bobbin winding unit | 12 | Touchscreen pen magnetic holder |

Overview back



- | | | | |
|---|-------------------------------|----|----------------------|
| 1 | Air vents | 9 | Bobbin winding unit |
| 2 | Connection for slide-on table | 10 | Thread pretension |
| 3 | Connection for darning hoop | 11 | Thread take-up lever |
| 4 | BERNINA Dual Feed | 12 | Thread guide |
| 5 | Carrying handle | 13 | Thread cutter |
| 6 | Spool pin | 14 | BSR connection |
| 7 | Thread guide | 15 | Feed dog |
| 8 | Retractable spool pin | 16 | Stitch plate |

1.5 Supplied accessories

Overview accessories machine





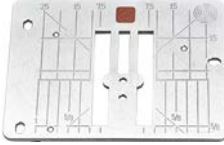











Illustration	Name	Purpose
	Dust cover	To protect the machine from dust and contamination.
	Accessories box	To store the supplied accessories as well as the optional accessories.
	Free Hand System (FHS)	To raise and lower the presser foot.
	Slide-on table	To increase the sewing surface.
	Seam guide for slide-on table	To support wide topstitching of edges.
	CutWork/Straight stitch plate	To sew straight stitches and for CutWork.
	Spool disc	To support the regular unwinding of the thread from the spool. 3 different sizes for thread spools in different sizes.
	Bobbin 4 pieces, 1 of them in the machine	To wind the bobbin thread.

Illustration	Name	Purpose
	Foam pad 2 pieces	To prevent the thread from slipping under the spool holder, tangling and breaking.
	Touchscreen pen	For precise operation of the touch display.
	Seam ripper	To undo seams and to cut buttonholes open.
	Height compensating tool	To level an angled position of the presser foot sole when sliding over thick seams.
	Selection of needles	For any common applications.
	Screwdriver red (slot)	To loosen and tighten slotted screws.
	Brush	To clean the feed dog and the looper area.
	Sewing machine oil	To oil the machine.
	Power cable	To connect the machine with the power supply system.
	Foot control	To start and stop the machine. To control the sewing speed.

Use of the power cable (only USA/Canada)

The machine has a polarized plug (one blade wider than the other). To reduce the risk of electrical shock, this plug is intended to fit in a polarized outlet only one way. If the plug does not fit fully in the outlet, reverse the plug. If it still does not fit, contact a qualified electrician to install the proper outlet. Do not modify the plug in any way!

Overview presser feet

Supplied standard presser feet











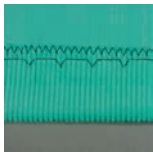

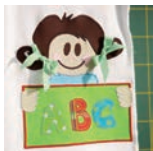

Illustration	Number	Name	Purpose	Example
	#1C	Reverse pattern foot	To sew various practical and decorative stitches. To sew forward and in reverse.	
	#1D	Reverse pattern foot	To sew various practical and decorative stitches with Dual Feed. To sew forward and in reverse.	
	#2A	Overlock foot	To finish edges in stretch material.	
	#3A	Automatic Buttonhole foot with slide	To sew buttonholes automatically.	
	#4D	Zipper foot	To sew in zippers with Dual Feed.	
	#5	Blindstitch foot	To sew blindstitch hems.	
	#20C	Open embroidery foot	To sew appliqués and decorative patterns.	

Illustration	Number	Name	Purpose	Example
	#42	BERNINA Stitch Regulator (BSR)	Free-motion quilting with regular stitch length.	

Accessory box



- | | | | |
|---|---------------|---|---|
| 1 | Drawer | 5 | Foam pad |
| 2 | Presser feet | 6 | Automatic Buttonhole foot with slide |
| 3 | Bobbin holder | 7 | Selection of needles |
| 4 | Spool discs | 8 | Holder for 5.5 mm and 9.0 mm presser feet |

1.6 Overview User Interface

Overview functions/Visual information

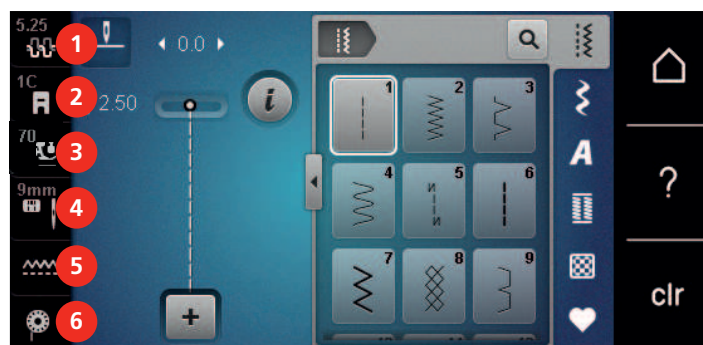

- | | | | |
|---|---|---|--------------------------------|
| 1 | Upper thread tension | 4 | Stitch plate/Needle selection |
| 2 | Presser foot display/Presser foot selection | 5 | Feed dog up/down |
| 3 | Presser foot pressure | 6 | Filling level of bobbin thread |

Overview System settings

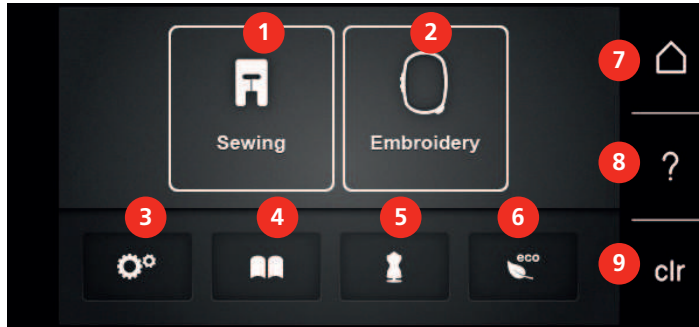

- | | | | |
|---|---|---|-------------------------|
| 1 | Sewing mode | 6 | eco |
| 2 | Embroidery mode | 7 | Home |
| 3 | Setup Program | 8 | Help |
| 4 | Tutorial | 9 | Back to default setting |
| 5 | Creative consultant (Sewing and Embroidery) | | |

Overview selection menu sewing

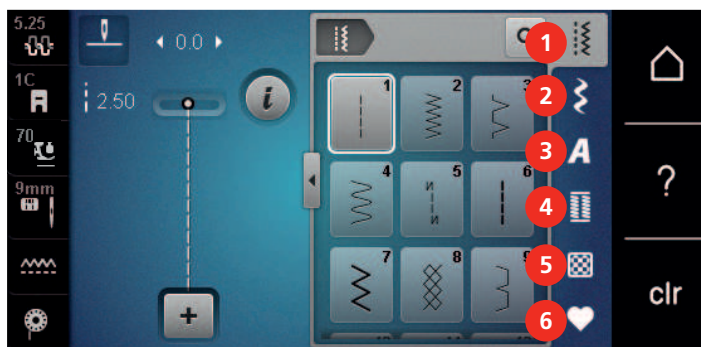

- | | | | |
|---|---------------------|---|-----------------|
| 1 | Practical stitches | 4 | Buttonholes |
| 2 | Decorative stitches | 5 | Quilt stitches |
| 3 | Alphabets | 6 | Personal Memory |

Overview Icons

Icon	Name	Purpose
	i-Dialog	Under the icon «i» dialog, you can find different functions for editing patterns.
	ESC	The window is closed and the changes that were previously set are implemented.
	Icons «-/+»	You can use the icons «-» and «+» to change setting values.
	Yellow frame around the icon	A yellow-framed icon indicates that a setting or value has been changed in this function. This can be reset to the default setting by touching the yellow-framed icon.
	Confirm	Confirms the changes that were previously made. The window is closed.
	Cancel	The process is canceled. The window is closed and the changes are not implemented.
	Slider	The slider is used to change setting values.
	Switch	The switch is used to switch functions on or off.

Icon	Name	Purpose
	Process navigation	You can use the process navigation to return to the previous display.

Please note: Some displays contain more functions than those displayed. You can display hidden functions by swiping your finger or the touchscreen pen upwards or downwards.

1.7 Needle, Thread, Fabric

In the course of time a needle wears out. Therefore it should be replaced regularly. Only a perfect point results in a good stitching result. In general it can be said: the thinner the thread, the finer the needle. The illustrated needles are either standard or optional accessory, depending on the machine.

- Needle sizes 70, 75: for thin fabrics.
- Needle sizes 80, 90: for medium fabrics.
- Needle sizes 100, 110 and 120: for heavy fabrics.

Overview Needles

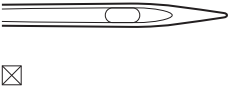
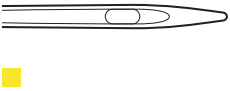
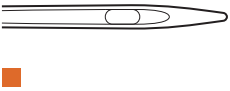
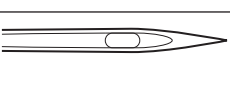
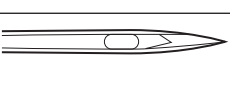
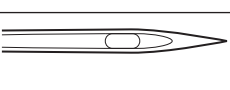
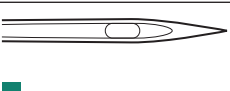
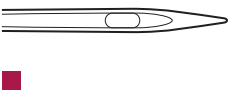
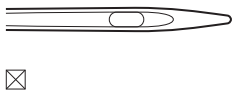
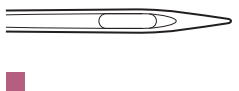
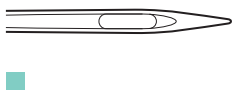

Illustration	Needle name	Needle description	Purpose
	Universal needle 130/705 H 60-120	Slightly rounded point	For nearly all natural and synthetic fabrics (woven and knitted).
	Stretch needle 130/705 H-S 75, 90	Mid-sized ball point, special eye shape and needle scarf	For jersey, tricot, knit and stretch fabrics.
	Jersey/Embroidery needle 130/705 H SUK 60-100	Mid-sized ball point	For knitware, knitted good. For embroidering.
	Jeans needle 130/705 H-J 80-110	Point, narrow point, reinforced shaft	For heavy-weight fabrics such as jeans or canvas.
	Leather needle 130/705 H LR 90, 100	With cutting point (LR = special point to sew leather)	For all types of leather, synthetic leather, plastic, sheeting.
	Microtex needle 130/705 H-M 60-110	Especially sharp, narrow point	For micro fiber fabrics and silk.
	Quilting needle 130/705 H-Q 75, 90	Slightly rounded fine point	For straight and topstitching.
	Embroidery needle 130/705 H-E 75, 90	Small ball point, especially wide needle eye and wide thread groove	For embroidery on all natural and synthetic fabrics.

Illustration	Needle name	Needle description	Purpose
	Fine-material needle 130/705 H SES 70, 90	Small ball point	For fine knitware and knitted materials. For embroidery on fine, delicate fabrics.
	Metafil needle 130/705 H METAFIL 80	Long needle eye (2 mm) in all needle sizes	For sewing or embroidering with metallic threads.
	Cordonnet needle (to patch embroidery) 130/705 H-N 70-100	Long needle eye (2 mm) in all needle sizes	Topstitching with thick thread.
	Felt needle PUNCH	Needle with barbed hook	For felt work.
	Hemstitch needle 130/705 H WING 100-120	Wing-like widened needle shaft (wing)	To sew blind stitches.
	Universal double needle 130/705 H ZWI 70-100	Needle distance: 1.0/1.6/2.0/2.5/3.0/4.0/6.0/8.0	For visible hems in stretch fabrics, pintucks, decorative sewing.
	Stretch double needle 130/705 H-S ZWI 75	Needle distance: 2.5/4.0	For visible hems in stretch fabrics, pintucks, decorative sewing.
	Hemstitch double needle 130/705 H ZWIHO 100	Needle distance: 2.5	For special effects with hemstitch embroidery.
	Universal triple needle 130/705 H DRI 80	Needle distance: 3.0	For visible hems in stretch fabrics, decorative sewing.

Example for needle description

The 130/705 system, which is the most common for household machines, is explained by the following picture of a Jersey/Stretch needle.

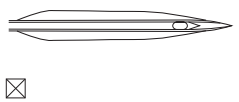
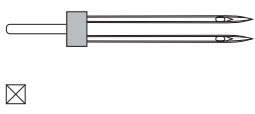
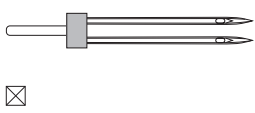
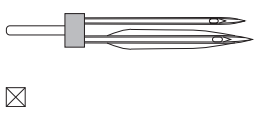
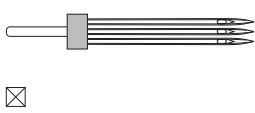
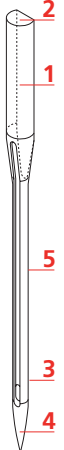

	<p>130/705 H-S/70</p> <p>130 = Shank length (1)</p> <p>705 = Flat shank (2)</p> <p>H = Needle scarf (3)</p> <p>S = Needle point (here medium ball point) (4)</p> <p>70 = Needle size 0.7 mm (5)</p>
---	---

Thread selection

For a perfect sewing result, thread and fabric quality play an important role.

We recommend purchasing quality threads to achieve good sewing results.

- Cotton threads have the advantage of being a natural fiber and therefore are especially suitable for sewing cotton fabrics.
- Mercerized cotton threads have a slight sheen that is not lost with washing.
- Polyester threads have a high tensile strength and is particularly colorfast.
- Polyester threads are more flexible and are recommended where a strong and elastic seam is required.
- Rayon threads are made of natural fibers and have a brilliant sheen.
- Rayon threads are suitable for decorative stitches and achieve a more beautiful effect.

Needle/thread combination

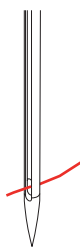
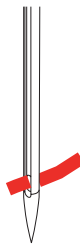
	<p>The needle/thread combination is correct, when the thread fits perfectly into the long groove and goes easily through the needle eye. The thread can be optimally secured.</p>
	<p>The thread can break and skipped stitches can occur when there is too much clearance in the long groove and the needle eye.</p>
	<p>The thread can break and get stuck when the thread scrapes against the edge of the long groove not fit well into the needle eye optimally.</p>

2 Sewing preparation

2.1 Accessory box

Removing and attaching the accessory box

The accessory box is fixed to the machine by means of four magnets. When attaching, the drawer has to be integrated in the accessory box.

- > Turn the carrying handle up and hold it in place.
- > Tilt the accessory box slightly to the front and pull off.



- > Close the doors of the accessory box.
- > Attach the accessory box to the machine, having the back towards the machine.

Storing accessories

NOTICE

Incorrect sorting of the bobbin

The silvery sensor surface can get scratched.

- > Make sure that the silvery sensor surfaces are on the right side when sorting the bobbins into the accessory box.

- > Insert the holders (1) for bobbins, feet and needles.
- > Store small parts in the drawer (2), e.g. oiler.
- > Insert the bobbins into the compartment (3) of the accessory box so that the silvery sensor surfaces are on the right side.
- > To remove a bobbin, press the compartment holder down.
- > Place small and medium-sized spool discs onto the pen (4).
- > Store foam pads in the compartment (5).
- > Store the buttonhole foot with slide No. 3A in the compartment (6).
- > Store the provided needle package in the special compartment (7).
- > Store the presser feet in the holders (1) (5.5 mm or 9.0 mm).



2.2 Connection and Switching on

Connecting the foot control

- > Unwind the cable of the foot control to the desired length.



- > Insert the cable of the foot control into the foot control connection.



Connecting the machine

- > Insert the power cable into the power cord connection.



- > Insert the power cable into the power cord connection.

Attaching the knee lifter of the Free Hand System



The lateral position of the knee lifter can be adjusted by your local BERNINA Dealer if required.

- > Insert the knee lifter into the opening at the front side of the machine.

- > Adjust the sitting height so that the knee lifter can be operated with the knee.



Fixing the touchscreen pen

- > Store the touchscreen pen at the magnet holder.



Switching the machine on

- > Switch on the machine at the main switch to «I».



2.3 Foot control

Regulating the speed via the foot control

Via the foot control the speed is infinitely variable.

- > Press the foot control down carefully to start the machine.
- > To sew faster, press the foot control harder.



- > Release the foot control to stop the machine.



Raising/Lowering the needle

- > Sink the heel back on the foot control to raise/lower the needle.



Programming the foot control individually

The foot control, i. e. the back kick function, can be programmed individually (see page 52).

2.4 Spool pin

Retractable spool pin

Raise the retractable spool pin



With metallic or other special threads, it is recommend to use the retractable spool pin.

The retractable spool pin is required when sewing with multiple threads, and can be used for spooling while sewing.

- > Position the appropriate spool disc on the spool pin so that there is no space between the spool disc and the thread spool.



Using a spool net

The spool net holds the thread on the thread spool and prevents the thread from knotting and breaking.

- > If available, slide the spool net over the thread spool.



2.5 Free arm

The BERNINA 590 provides a solidly designed free arm which offers a lot of space for large project on the right of the needle.

2.6 Feed dog

Adjusting the feed dog

NOTICE

Inappropriate handling of the fabric

Damage of the needle and the stitch plate.

- > Let the sewing project be fed evenly.

With each stitch, the feed dog moves forward by one step. The length of this step is determined by the stitch length selected.

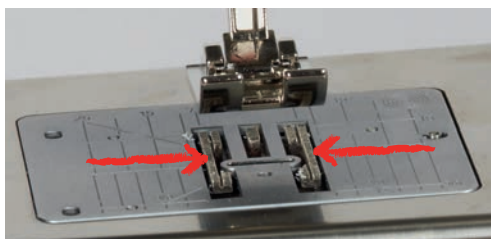

With a short stitch length, the steps are very short. For example when sewing buttonholes and satin stitches. The fabric is fed slowly under the presser foot, even when sewing at maximal speed.

- > To remove the slide-on table, press the button at the table down and pull the slide-on table over the free arm to the left.



Using the edge guide

Fitting the edge guide

Prerequisite:

- The extension table has been fitted.
- > Touch the release button and engage the edge guide from the front to the back on the extension table.



Removing the edge guide

- > Touch the release button and pull the edge guide away to the front.

2.8 Presser foot

Adjusting the presser foot position via the knee lifter of the Free Hand System

- > Adjust the sitting height so that the knee lifter can be operated with the knee.
- > Push the knee lifter with the knee to the right to raise the presser foot.

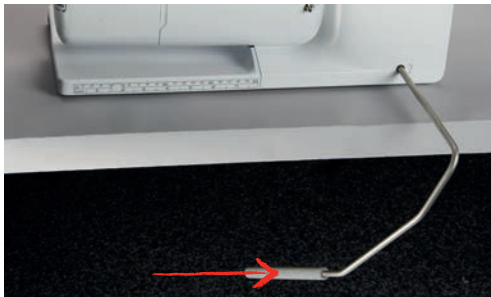

- Simultaneously the feed dog is lowered and the thread tension is released.
- > Release the knee lifter slowly to lower the presser foot.

Adjusting the presser foot position via the button «Presser foot up/down»



- > Push the button «Presser foot up/down» to raise the presser foot.
- > Push the button «Presser foot up/down» again to lower the presser foot.

Changing the presser foot

- > Raise the needle.
- > Raise the presser foot.
- > Switch the machine off and disconnect it from the power supply system.
- > Push the clamping lever up (1).
- > Remove the presser foot (2).



- > Guide the new presser foot upwards over the cone.
- > Press the clamping lever down.

Selecting the presser foot in the user interface

After having replaced the presser foot, it can be checked whether it suits for the selected stitch pattern. Moreover, optional presser feet, which are also available for the respective stitch pattern, are displayed.

- > Switch the machine on.
- > Select the stitch pattern.
- > Touch the icon «Presser foot display/Presser foot selection».



- > Touch the icon «Optional presser feet» to display all suitable presser feet for the selected stitch pattern.



- > Select the attached presser foot.
 - When the selected presser foot is suitable, sewing can start.
 - If the selected presser foot is not suitable for the selected stitch pattern, it can be chosen but starting the machine is automatically prevented. An error message appears. With an incorrectly selected presser foot, the preview of the stitch pattern will be displayed in red.



Adjusting the presser foot pressure



The presser foot pressure is designed to adjust the pressure of the presser foot optimally to the fabric thickness. When working with thick fabrics, it is recommended to reduce the presser foot pressure. This provides the advantage that the presser foot is slightly lifted so that the fabric can be moved more easily. When working with thin fabrics, it is recommended to increase the presser foot pressure. This provides the advantage that the fabric cannot be moved too easily under the presser foot.



- > Touch the icon «Presser foot pressure».
- > Move the slide with the touchscreen pen/finger to adjust the presser foot pressure.

2.9 Instruction for adjusting the feed dog



- > Touch the icon «Feed dog up/down».
- > Raise or lower the feed dog according to the animation.

2.10 Needle and stitch plate

Changing the needle

- > Raise the needle.
- > Switch the machine off and disconnect it from the power supply system.
- > Remove the presser foot.
- > Loosen the fixing screw of the needle manually.



- > Pull the needle down.
- > Hold the new needle with the flat side to the back.
- > Insert the needle as far as it will go.
- > Tighten the fixing screw manually.

Selecting the needle in the User Interface

After having changed the needle, it can be checked whether or not it can be used in combination with the selected stitch plate.



- > Touch the icon «Stitch plate/Needle selection».



- > Select the inserted needle.

Selecting the needle type and the needle size

Convenient memory function: To prevent a loss of information, the needle type and the needle size can be saved additionally on the machine. The saved needle type and the saved needle size can be checked at any time.



- > Touch the icon «Stitch plate/Needle selection».

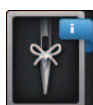

- > Touch the icon «Needle type/Needle size».
- > Select the needle type (1) of the inserted needle.
- > Select the needle size (2) of the inserted needle.



Adjusting the needle position up/down



- > Push the button «Needle up/down» to lower the needle.
- > Push the button «Needle up/down» again to raise the needle.

Adjusting the needle position left/right

There is a total of 11 needle positions. The needle position is indicated by the needle position number in the display.

- > Push the button «Needle left» (1) to move the needle to the left.

- > Push the button «Needle right» (2) to move the needle to the right.



Needle stop up/down (permanent)



- > Touch the icon «Needle stop up/down (permanent)» to fix the needle position permanently.
 - The machine stops with needle position down as soon as the foot control is released or the button «Start/Stop» has been pressed.
- > Touch the icon «Needle stop up/down (permanent)» again.
 - The machine stops with needle position up as soon as the foot control is released or the button «Start/Stop» has been pressed.

Changing the stitch plate

The stitch plate is marked with vertical, horizontal and diagonal lines in millimeters (mm) and inches (inch). These lines help to guide the fabric when sewing seams and precise topstitching.

Prerequisite:

- The feed dog is lowered.
 - The machine is switched off and disconnected from the power supply system.
 - Needle and presser foot are removed.
- > Press the stitch plate down at the mark back right until it flips up.



- > Remove the stitch plate.

- > Place the openings of the new stitch plate above the corresponding guide pins and press down until it clicks into place.

Selecting the stitch plate in the User Interface

After having changed the stitch plate, it can be checked whether or not it is suitable to be used in combination with the selected needle.



- > Touch the icon «Stitch plate/Needle selection».
- > Select the previously attached the stitch plate.



- If the selected stitch plate is suitable in combination with the needle, sewing can be started.
- If the selected stitch plate is not suitable in combination with the needle, starting the machine is automatically blocked.

2.11 Threading

Threading the upper thread

Preparing the threading

- > Place the foam pad on the spool holder.
- > Place the thread spool on the spool holder so that the thread unwinds clockwise.
- > Add the appropriate spool disc.
- > Switch on the machine and wait until it starts up.
- > Raise the needle and presser foot.

Guiding the thread to the needle

- > Hold the thread with one hand between the thread spool and rear thread guide (1). Use the other hand to hold the thread at the end and, during the subsequent steps, always keep it under light tension.
- > Guide the thread in direction of the arrow through the thread tension (2).

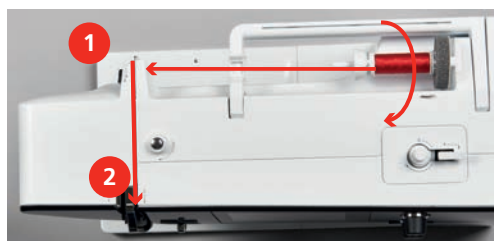

- > Guide the thread downwards around the thread take-up lever cover (3) and then upwards.

- > Insert the thread in the thread take-up lever (4).

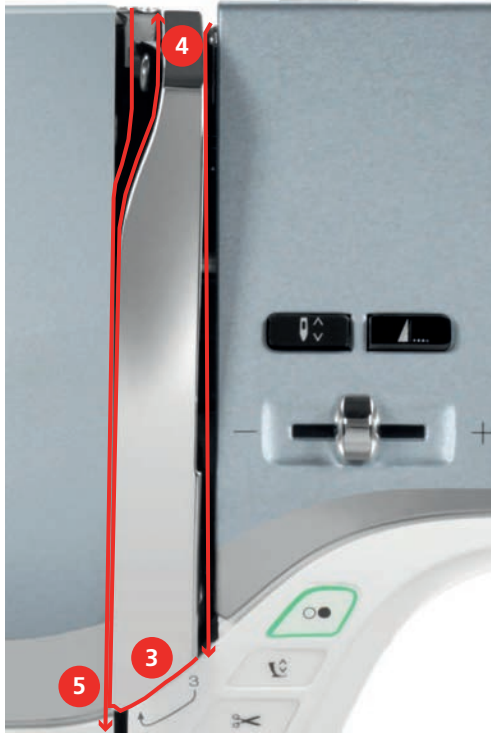

- > Guide the thread downwards again (5).
- > Only release the thread now.
- > Switch the machine off.

Threading the needle

- > Guide the thread through the guides (6/7) above the presser foot.



- > Pull the thread below the presser foot and through to the thread cutter (15), and cut it.

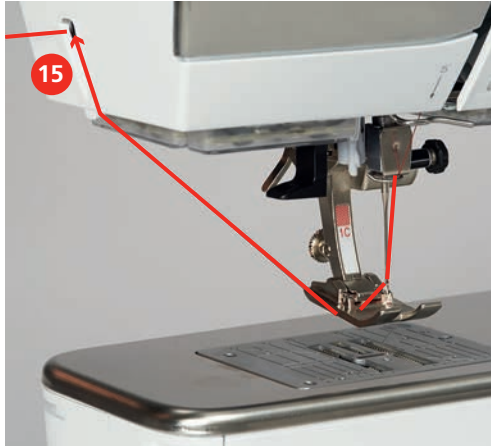

Threading the double needle

Prerequisite:

- The double needle is inserted.
- > Guide the first thread in direction of the arrow on the right side of the tension disc (1).
- > Guide the second thread in direction of the arrow on the left side of the tension disc (1).

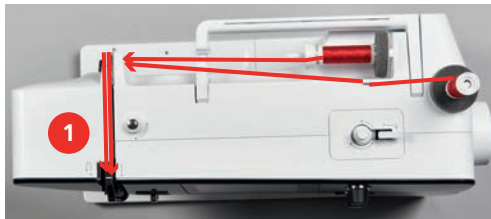

- > Guide the first and the second thread to the thread guide above the needle.
- > Thread the first thread manually into the right needle.
- > Thread the second thread manually into the left needle.

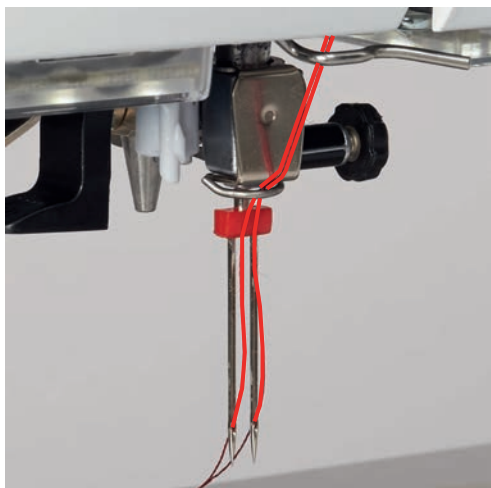

Threading the Triple Needle



Always insert a foam pad when using the retractable spool pin. It prevents the thread from getting hooked at the spool pin.

Prerequisite:

- The triple needle is inserted.
- > Place the foam pad, the thread spool and the appropriate spool disc on the spool holder.
- > Place the filled bobbin on the retractable spool pin.
- > Add the appropriate spool disc.
- > Place the thread spool.
- > Thread the 3 threads up to the upper thread guide.



- > Guide 2 threads past the thread tension discs (1) on the left and to the thread guide above the needle.
- > Guide 1 thread past the thread tension discs (1) on the right and to the thread guide above the needle.
- > Thread the first thread into the left needle manually.
- > Thread the second thread into the center needle manually.
- > Thread the third thread into the right needle manually.

Winding the bobbin thread



The bobbin thread can be wound while embroidering if the retractable spool pin is used for winding.

Prerequisite:

- The foam pad, the thread spool and the appropriate thread disc are positioned.
- > Attach the empty bobbin on the winding unit so that the silvery sensor surface is down.



- > Guide the thread to the left into the rear thread guide (1).
- > Guide the thread around the thread pretension clockwise (2).
- > Wind the thread clockwise 2 to 3 times around the empty bobbin (3).
- > Pull the thread over the thread cutter at the engaging lever (4) and cut.

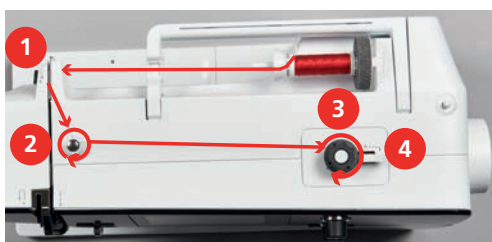

- > Insert the new bobbin so that the silvery sensor surface is facing the back of the bobbin case.



- > Pull the thread into the slot (2) from the left.



- > Pull the thread to the right under the spring (3), then lead the thread under the two thread guides (4) and pull upwards.



- > When inserting into the machine, hold the bobbin case so the thread guide (5) points upwards.

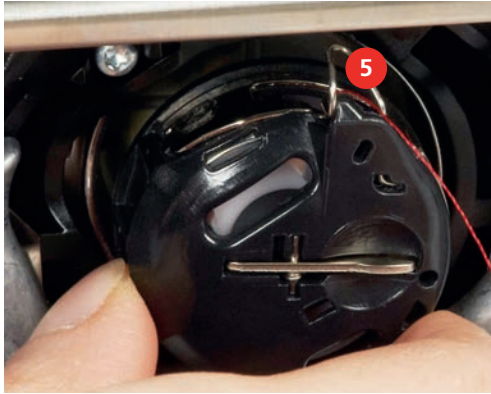

- > Insert the bobbin case.
- > Press onto the center of the bobbin case until it engages.
- > Pull the thread through the thread cutter (6) and cut.

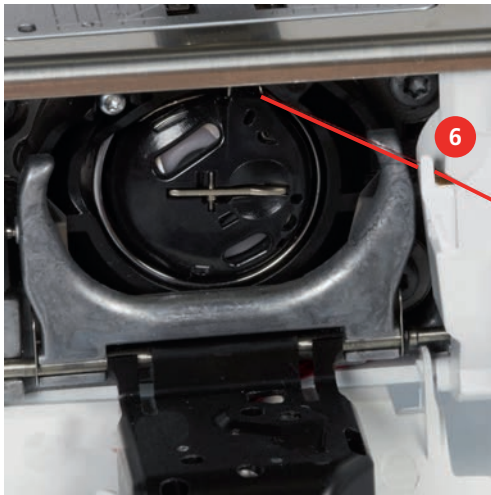

- > Close the bobbin cover.

Indicating fill level of bobbin thread

As soon as the fill level of the bobbin thread is low, an animation, which indicates that the bobbin thread is running out, appears in the icon «Bobbin thread fill level».

- > Touch the icon «Bobbin thread fill level» to thread the bobbin thread according to the animation.



3 Setup Program

3.1 Sewing settings

Adjusting the upper thread tension

Changes to the upper thread tension in the Setup Program affect all of the stitch patterns. You can also make changes to the upper thread tension which then apply for the selected stitch pattern in each case. The setting in the setup is retained after the machine is switched off.



> Touch the icon «Home».



> Touch the icon «Setup Program».



> Touch the icon «Sewing settings».



> Touch the icon «Change upper thread tension».
 > To increase the upper thread tension, slide the slider to the right or touch the icon «+».
 > To decrease the upper thread tension, slide the slider to the left or touch the icon «-».

Adjusting the maximum sewing speed

You can use this function to set the maximum speed.



> Touch the icon «Home».



> Touch the icon «Setup Program».



> Touch the icon «Sewing settings».



> Touch the icon «Change maximum speed».
 > To decrease the maximum sewing speed, slide the slider to the left or touch the icon «-».
 > To increase the maximum sewing speed, slide the slider to the right or touch the icon «+».

Programming securing stitches

If the function is switched on, at the start of the pattern, four securing stitches are automatically sewn after the thread cut.



> Touch the icon «Home».



> Touch the icon «Setup Program».



> Touch the icon «Sewing settings».



- > To switch off securing stitches at the start of the pattern, set the switch to «0».
- > To switch on securing stitches at the start of the pattern, set the switch to «I».

Adjusting the hovering height of the presser foot

The floating height of the presser feet can be set from 0 to max. 7 mm (0.27 in), depending on the fabric thickness.

Set floating height = fabric thickness + required clearance between the fabric and the presser foot in the floating position.



> Touch the icon «Home».



> Touch the icon «Setup Program».



> Touch the icon «Sewing settings».



> Touch the icon «Program buttons and icons».



- > Touch the icon «Adjustable presser foot floating height».
- > To set the floating height, turn the «Upper multifunction knob» or «Lower multifunction knob» or touch the icons «-» or «+».

Programming the button «Pattern end»

The presser foot can be positioned, the thread cut and the automatic securing can be programmed.



> Touch the icon «Home».



> Touch the icon «Setup Program».



> Touch the icon «Sewing settings».



> Touch the icon «Program buttons and icons».



> Touch the icon «Program the button Pattern end».



> Touch the icon «Securing» to program 4 securing stitches in place.

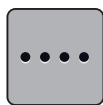

> Touch the icon «Alter the number of securing stitches» to program securing stitches in close succession.
> Touch the icons «-» or «+» to program the number of securing stitches in close succession.

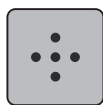

> Touch the icon «Securing stitches in place» to program 4 securing stitches in place.



> Touch the icon «Thread cut» to deactivate the automatic thread cut after securing.
> Touch the icon «Thread cut» again to activate the automatic thread cut after securing.



> Touch the icon «Position the presser foot» so that the presser foot remains down after securing.
> Touch the icon «Position the presser foot» again so that the presser foot remains up after securing.



> Touch the icon «Securing» to deactivate the automatic securing.
> Touch the icon «Securing» again to activate the automatic securing.

Programming the button «Thread cutter»

The automatic securing can be programmed before the thread cut takes place.



> Touch the icon «Home».



> Touch the icon «Setup Program».



> Touch the icon «Sewing settings».



> Touch the icon «Program buttons and icons».



> Touch the icon «Program the button thread cutter».



> Touch the icon «Securing» to sew 4 securing stitches in place.

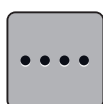

> Touch the icon «Alter the number of securing stitches» to program the number of securing stitches in close succession.
> Touch the icons «-» or «+» to program the number of securing stitches.

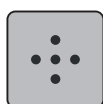

> Touch the icon «Securing stitches in place» to program 4 securing stitches in place.



- > Touch the icon «Securing» deactivate the automatic securing.
- > Touch the icon «Securing» again to activate the automatic securing.

Adjusting the presser foot position with needle stop down

With lowered needle, 3 different presser foot position can be selected: the presser foot lowered, the presser foot is raised to hovering position and the presser foot is raised to its maximum height.



- > Touch the icon «Home».



- > Touch the icon «Setup Program».



- > Touch the icon «Sewing settings».



- > Touch the icon «Program buttons and icons».



- > Touch the icon «Adjust the presser foot position with needle stop down».



- > Select the desired presser foot position.

Programming the button «Quick reverse»

You can choose between «Reverse sewing» and «Stitch-specific reverse sewing».



- > Touch the icon «Home».



- > Touch the icon «Setup Program».



- > Touch the icon «Sewing settings».



- > Touch the icon «Program buttons and icons».



- > Touch the icon «Program reverse sewing button».



- > To set the stitch-precise reverse sewing, touch the icon «Stitch-precise reverse sewing».
 - The icon has a white frame.

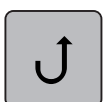

- > To set reverse sewing, touch the icon «Reverse sewing».
 - The icon has a white frame.

Programming the foot control

When the icon «Needle up/down» is activated, the needle is raised or lowered via a back kick on the foot control. Alternatively, the presser foot can be positioned, the thread can be cut and the automatic securing can be programmed.



> Touch the icon «Home».



> Touch the icon «Setup Program».



> Touch the icon «Sewing settings».



> Touch the icon «Program the foot control».

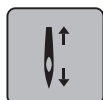

- The icon «Needle up/down» is activated by default.
- The back kick on the foot control raises or lowers the needle.



> Touch the icon «Program the back kick» to program the back kick.



> To program 4 securing stitches in place, touch the icon «Securing».

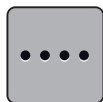

- > To program securing stitches in close succession, touch the icon «Alter the number of securing stitches».
- > To program the number of securing stitches, touch the icons «-» or «+».

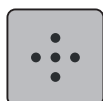

> To program 4 securing stitches in place, touch the icon «Securing stitches in place».



- > To deactivate the automatic securing via the back kick, touch the icon «Securing».
- > To activate the automatic securing via the back kick, touch the icon «Securing» again.



- > To deactivate the automatic thread cut, touch the icon «Thread cut».
- > Touch the icon «Thread cut» again to activate the thread cut via the back kick.



- > Touch the icon «Position the presser foot» so that the presser foot remains down via the back kick.
- > Touch the icon «Position the presser foot» again so that the presser foot remains up via the back kick.

3.2 Embroidery settings

Adjusting the upper thread tension

Changes to the upper thread tension in the Setup Program affect all of the embroidery motifs. The setting in the Setup Program is retained after the machine is switched off.



> Touch the icon «Home».



> Touch the icon «Setup Program».



> Touch the icon «Embroidery settings».



> Touch the icon «Change upper thread tension».

> To increase the upper thread tension, slide the slider upwards or touch the icon «+».

> To decrease the upper thread tension, slide the slider downwards or touch the icon «-».

Adjusting the maximum embroidering speed

You can use this function to reduce the maximum speed.



> Touch the icon «Home».



> Touch the icon «Setup Program».



> Touch the icon «Embroidery settings».



> Touch the icon «Change maximum speed».

> To decrease the embroidery speed, slide the slider to the left or touch the icon «-».

> To increase the maximum embroidery speed, slide the slider to the right or touch the icon «+».

Setting the embroidery motif position when opening

As the default setting, opened embroidery motifs are always displayed in the center of the hoop. You can use the switch «Restore saved embroidery motif position» to set that embroidery motifs are opened at the position in the hoop at which they had been saved in the BERNINA stitch software.



> Tap «Home».



> Touch the icon «Setup Program».



> Touch the icon «Embroidery settings».



> Touch the icon «Center the embroidery motif».



- > To open the embroidery motif at the saved position, set the switch «Restore saved embroidery motif position» to «I».
- > To open the embroidery motif in the center of the hoop, set the switch «Restore saved embroidery motif position» to «0I».

Calibrating the hoop

The calibration of the embroidery hoop is the coordination of the needle to the center of the embroidery hoop.

Prerequisite:

- The embroidery module is connected.
- The hoop is fitted with the corresponding embroidery pattern.



> Touch the icon «Home».



> Touch the icon «Setup Program».



> Touch the icon «Embroidery settings».



- > Touch the icon «Calibrating the hoop».
- > Use the arrow icons on the display to move the needle precisely to the center of the pattern.





> Accept the needle position using the icon «Confirm».

Entering the fabric thickness

If the fabric thickness, as for e.g. toweling is more than 4 mm (0.15 inch) it is recommended to select 7.5 mm (0.29 inch) or 10 mm (0.39 inch). The thicker the fabric, the slower the embroidery speed of the machine. When the machine is switched off, the alterations are reset to the default setting 4 mm (0.15 inch).







> Touch the icon «Home».

-  > Touch the icon «Setup Program».
-  > Touch the icon «Embroidery settings».
-  > Touch the icon «Select fabric thickness».
> Select fabric thickness.





Function thread away on/off

To pull the thread end out of the fabric being cut, the function must be activated. For embroidery motifs with long stitches, it is recommended to deactivate the function thread away. When the distance between the presser foot and the embroidery hoop is too short, the function is not carried out.

-  > Touch the icon «Home».
-  > Touch the icon «Setup Program».
-  > Touch the icon «Embroidery settings».
-  > Touch the icon «Thread away».
-  > To activate the function thread away, set the switch to «I».
> To deactivate the function thread away, set the switch to «0».

Programming securing stitches (Smart Secure)

Embroidery motifs are programmed with or without securing stitches. The machine detects if no securing stitches are programmed and adds these.

-  > Touch the icon «Home».
-  > Touch the icon «Setup Program».
-  > Touch the icon «Embroidery settings».
-  > Touch the icon «Securing stitches on/off».
-  > To switch off securing stitches at the start, move the switch in the upper right-hand area to «0».
 - If the embroidery motif has programmed securing stitches, they will be embroidered.
 - If the embroidery motif doesn't have any programmed securing stitches, none are embroidered.

- > To switch on securing stitches at the start, move the switch in the upper right-hand area to «I».
 - If the embroidery motif has programmed securing stitches, they will be embroidered.
 - If the embroidery motif doesn't have any programmed securing stitches, the securing stitches are added and will be embroidered.
- > To switch off securing stitches at the end, move the switch in the lower right-hand area to «0».
 - If the embroidery motif has programmed securing stitches, they will be embroidered.
 - If the embroidery motif doesn't have any programmed securing stitches, none are embroidered.
- > To switch on securing stitches at the end, move the switch in the lower right-hand area to «I».
 - If the embroidery motif has programmed securing stitches, they will be embroidered.
 - If the embroidery motif doesn't have any programmed securing stitches, the securing stitches are added and will be embroidered.

Adjusting the thread cut

The settings for the thread cut can be customized. Deactivate the thread cut after a color change (1) or adjust the length of the connecting stitch (3). The machine does the cutting of the connecting threads at the determined length for you. First, set the length from which the connecting stitches are cut, and then select the embroidery motif.



The length of the connecting thread can be adjusted between 1 mm and 15 mm, the default setting is 6 mm. This means that all connecting stitches longer than 6 mm are cut automatically. If the value is reduced to 1 mm, more thread cuts are carried out, it takes longer to embroider and more loose thread ends can be seen on the wrong side of the fabric, especially when the function 'Thread-away' is activated too. On the right side of the fabric there will be practically none or merely very short connecting stitches which results in a wonderful stitch formation. Reducing the length of the thread cut to 1 mm is particularly of advantage when embroidering texts where usually many short connecting threads occur. As for other embroidery motifs (specifically when both sides of the embroidery motifs are visible) it may be reasonable to not reduce the length of the thread cut so much so that there won't be too many loose thread ends on the wrong side of the fabric. These loose ends get sewn over and can hardly be removed afterwards.



> Touch the icon «Home».



> Touch the icon «Setup Program».



> Touch the icon «Embroidery settings».







> Touch the icon «Thread cut settings».



- > To switch off the automatic thread cut before changing the thread, move the switch in the upper area of the display (1) to «0».
- > To switch on the automatic thread cut before changing the thread, move the switch in the upper area of the display (1) to «I».
- > To stop the machine for the manual thread cut, move the switch in the central area of the display (2) to «I».
- The machine stops after approx. seven stitches; the thread can be cut by hand.
- > To not stop the machine for the manual thread cut, move the switch in the central area of the display (2) to «0».
- > To set the length from which the connecting stitches are cut, touch the icons «-» or «+» (3).

Changing the measuring unit

The unit of measurement in the embroidery mode can be changed from mm to inches. The default setting is mm.

-  > Touch the icon «Home».
-  > Touch the icon «Setup Program».
-  > Touch the icon «Embroidery settings».
-  > Touch the icon «Change measuring unit».
- > To change the unit of measurement in embroidery mode to inches, touch the icon «Inch» (1).
- > To change the unit of measurement in embroidery mode to mm, touch the icon «mm» (2).

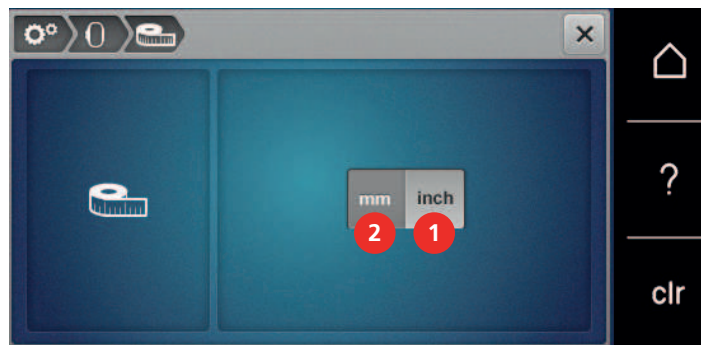

3.3 Selecting personal settings



> Touch the icon «Home».



> Touch the icon «Setup Program».



> Touch the icon «Own settings».



- > Select the required display color and background.
- > To change the welcome message, touch the text field above the color settings.
- > Enter the welcome message.
- > For upper-case letters, touch the icon «ABC» (default setting).
- > For lower-case letters, touch the icon «abc».
- > For numbers and mathematical symbols, touch the icon «123».
- > For special characters, touch the icon «@&!».
- > To completely delete the text, touch inside the text field above the keyboard.
- > To delete individual letters, touch the icon «DEL».



> To accept the text, touch the icon «Confirm».



> Close the window.



> Touch the icon «Home».
– The welcome message is saved.

3.4 Monitoring functions

Activating the upper thread indicator



> Touch the icon «Home».



> Touch the icon «Setup Program».



> Touch the icon «Monitoring settings».

3.6 Machine settings

Selecting a language



> Tap «Home».



> Tap «Setup Program».



> Tap «Machine settings».



> Tap «Language selection».
> Tap the required language.

Adjusting the brightness of the display

The brightness of the display can be set to meet your individual needs.



> Touch the icon «Home».



> Touch the icon «Setup Program».



> Touch the icon «Machine settings».



> Touch the icon «Adjust brightness».
> To change the display brightness, slide the slider in the upper area of the display to the left or right, or touch the icons «+» or «-».

Adjusting the sewing light

You can set the brightness of the sewing light to meet your individual needs.



> Touch the icon «Home».



> Touch the icon «Setup Program».



> Touch the icon «Machine settings».



> Touch the icon «Adjust brightness».



> To switch off the sewing light, move the switch to «0».



> Touch the icon «Setup Program».



> Touch the icon «Machine settings».



> Touch the icon «Information».



> To enter the dealer details, touch the icon «Dealer data».



> To enter the company name of the specialized BERNINA dealer, touch the icon «Company name».



> To enter the address of the specialized BERNINA dealer, touch the icon «Address».



> To enter the telephone number for the specialized BERNINA dealer, touch the icon «Telephone».



> To enter the website or e-mail address for the specialized BERNINA dealer, touch the icon «Internet».

Saving Service data

The service data regarding the current status of the machine can be saved on the BERNINA USB stick (optional accessory) and provided to the specialized BERNINA dealer.

- > Insert the BERNINA USB stick (optional accessory) with enough free capacity into the machine's USB slot.
- > Touch the icon «Home».



> Touch the icon «Setup Program».



> Touch the icon «Machine settings».



> Touch the icon «Information».













- > Touch the icon «Service data».
- > Touch the icon «LOG».
- The icon "LOG" has a white frame.

> Ensure that the white frame is no longer displayed and remove the BERNINA USB stick (optional accessory).









Back to basic setting

WARNING: Using this function will delete all individually made settings.

-  > Touch the icon «Home».
-  > Touch the icon «Setup Program».
-  > Touch the icon «Machine settings».
-  > Touch the icon «Default settings».
-  > Touch the icon «Default setting sewing».
-  > To restore the default sewing settings, touch the icon «Confirm».
-  > Touch the icon «Default embroidering setting».
-  > To restore the default embroidery settings, touch the icon «Confirm».
-  > Touch the icon «Default setting all».
-  > To restore all of the default settings, touch the icon «Confirm» and restart the machine.

Deleting user data

Motifs which are not needed anymore can be deleted so that there will be more capacity for new motifs.

-  > Touch the icon «Home».
-  > Touch the icon «Setup Program».
-  > Touch the icon «Machine settings».
-  > Touch the icon «Default settings».
-  > Touch the icon «Delete data from the personal memory».
-  > Touch the icon «Confirm» to delete all data from the personal memory.
-  > Touch the icon «Delete personal embroidery motifs».
-  > Touch the icon «Confirm» to delete all embroidery motifs from the personal memory.

Deleting motifs on the BERNINA USB Stick

When motifs which won't be needed anymore are saved on the BERNINA USB Stick (Optional accessory), the stick can be connected to the machine and the data can be deleted.

- > Insert the BERNINA USB Stick (Optional accessory) into the den USB port of the machine.
- > Touch the icon «Home».



- > Touch the icon «Setup Program».



- > Touch the icon «Machine settings».



- > Touch the icon «Default settings».



- > Touch the icon «Delete data from USB Stick».



- > Touch the icon «Confirm» to delete all data on the BERNINA USB Stick (optional accessory).



Calibrating the Buttonhole foot No. 3A

The Buttonhole foot with slide No. 3A and the machine are synchronized with each other and should only be used together.

Prerequisite:

- The Buttonhole foot No. 3A is attached.
- The needle is not threaded.

- > Touch the icon «Home».



- > Touch the icon «Setup Program».



- > Touch the icon «Machine settings».



- > Touch the icon «Maintenance/Update».



- > Touch the icon «Calibrate the Buttonhole foot No. 3A».



- > To start the calibration, touch the button «Start/Stop».



- > After the calibration is finished, close the window.



Updating the machine Firmware

The machine's current firmware and detailed step-by-step instructions for the update process can be downloaded from www.bernina.com. In general, personal data and settings are automatically transferred during a firmware update. For reasons of safety, it is also recommended to save data and settings on a BERNINA USB stick (optional accessory) before the firmware update is started. If personal data and settings should get lost during a firmware update, they can be transferred to the machine again afterwards.

NOTICE

The BERNINA USB stick (optional accessory) has been removed too early

Firmware has not been updated and the machine cannot be used.

> Remove the BERNINA USB stick (optional accessory) only after the update has been completed successfully.

> Insert the BERNINA USB stick (optional accessory), FAT32 formatted, providing the latest software into the port.

> Touch the icon «Home».



> Touch the icon «Setup Program».



> Touch the icon «Machine settings».



> Touch the icon «Maintenance/Update».



> Touch the icon «Update the machine».



> Touch the icon «Save data on USB stick».
– The icon is checkmarked in green.



Update

> To start the firmware update, touch the icon «Update».

Recovering saved data

If personal data and settings after a software update are not available anymore, they can be transferred to the machine again afterwards.

NOTICE

The BERNINA USB stick (optional accessory) has been removed too early

Saved data cannot be transferred and the machine cannot be used.

> Remove the BERNINA USB stick (optional accessory) only after the saved data has been transferred successfully.

> Insert the BERNINA USB stick (optional accessory) providing the saved data and settings into the USB port of the machine.

> Touch the icon «Home».



Setup Program



> Touch the icon «Setup Program».



> Touch the icon «Machine settings».



> Touch the icon «Maintenance/Update».



> Touch the icon «Update the machine».



> Touch the icon «Transfer saved data to machine».
– The icon is checkmarked in green.

Cleaning the thread catcher

The chapter «Maintenance and cleaning» provides additional illustrated step-by-step instructions for this.



> Touch the icon «Home».



> Touch the icon «Setup Program».



> Touch the icon «Machine settings».



> Touch the icon «Maintenance/Update».



> Touch the icon «Clean thread catcher».
> Clean the thread catcher according to the instructions on the display.

Lubricating the machine



Electronically driven components

Risk of injury near the needle and the hook.

> Switch the machine off and disconnect it from the power supply system.







Lubricating the hook

Too much oil can pollute the fabric and the thread.

> After lubricating, sew/embroider a test piece first.

The Setup Program provides animations how the machine has to be oiled. In chapter «Maintenance and cleaning» there are additional illustrated step-by-step instructions. Always use BERNINA oil to lubricate.





-  > Touch the icon «Home».
-  > Touch the icon «Setup Program».
-  > Touch the icon «Machine settings».
-  > Touch the icon «Maintenance/Update».
-  > Touch the icon «Lubricate the machine».
> Lubricate the machine according to the instructions on the display.

Packing the embroidery module

To pack the embroidery module into the original packaging without moving the embroidery arm manually, the embroidery arm needs to be brought to its packing position.

Prerequisite:

- The embroidery module is connected with the machine.

-  > Touch the icon «Home».
-  > Touch the icon «Setup Program».
-  > Touch the icon «Machine settings».
-  > Touch the icon «Maintenance/Update».
-  > Touch the icon «Packing position for embroidery module».
> Follow the instructions on the display.

4 System settings

4.1 Calling up the Tutorial

The Tutorial gives information and explanations, covering various aspects of sewing, embroidering and the different stitches.



- > Touch the icon «Home».



- > Touch the icon «Tutorial».
- > Select the desired topic to get information.

4.2 Calling up the Creative Consultant

The Creative Consultant informs you about decision support for sewing projects. After entering the kind of fabric and the desired sewing project, suggestions concerning the suitable needle or the appropriate presser foot are displayed.



- > Touch the icon «Home».



- > Touch the icon «Creative Consultant».
- > Select the fabric on which you want to sew.
- > Select the sewing project.

4.3 Using eco mode

For a longer work stoppage, the machine can be put into energy-saving mode.



- > Touch the icon «Home».



- > Touch the icon «eco mode».
 - The display goes to sleep. The power consumption is reduced and the sewing light is off.
- > To exit energy-saving mode, touch the eco symbol on the display.
 - The machine is ready for use.

4.4 Calling up the embroidery consultant

The Embroidery Consultant informs you about decision support for embroidery projects. After entering the desired embroidery project and the fabric, suggestions for the suitable needle and the suitable embroidery foot are displayed.

Prerequisite:

- Embroidery mode is active.



- > Touch the icon «Home».



- > Touch the icon «Embroidery consultant».
- > Select the embroidering project.
- > Select the fabric on which you want to embroider.
- > Touch the icon «Confirm».
 - If an embroidery motif has already been selected, a warning appears stating that this will be overwritten.

4.5 Calling up the Help



- > Touch the window in the display where help is needed.
- > Touch the icon «Help» to start the help mode.
- > Touch the icon in the display where help is needed.
 - Assistance concerning the selected icon is displayed.

4.6 Cancelling any alterations with «clr»

Any alterations to motifs can be reset to default setting. Exceptions are saved motifs which have been filed in the personal memory and monitoring functions.



- > Touch the icon «clr».

5 Creative sewing

5.1 Overview selection menu sewing

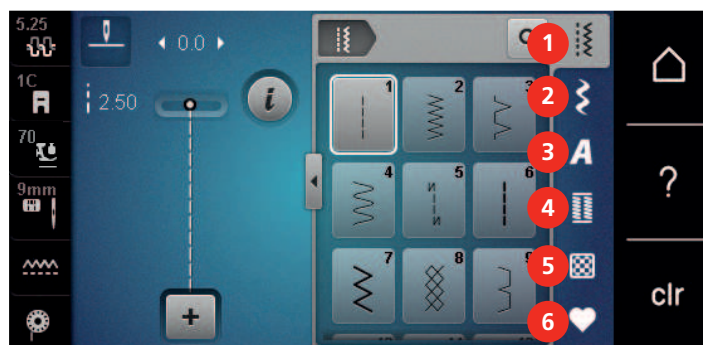

- | | | | |
|---|---------------------|---|-----------------|
| 1 | Practical stitches | 4 | Buttonholes |
| 2 | Decorative stitches | 5 | Quilt stitches |
| 3 | Alphabets | 6 | Personal Memory |

Selecting a stitch pattern

- > Select a stitch pattern, alphabet or buttonhole.
- > With the touchscreen pen/finger scroll up within the range of the practical stitches, alphabets or buttonholes to have more stitch patterns displayed.
- > Touch the icon «Display all the stitch patterns» (1) to scale up the view.
- > Touch the icon «Display all the stitch patterns» (1) again to downsize the stitch pattern view.

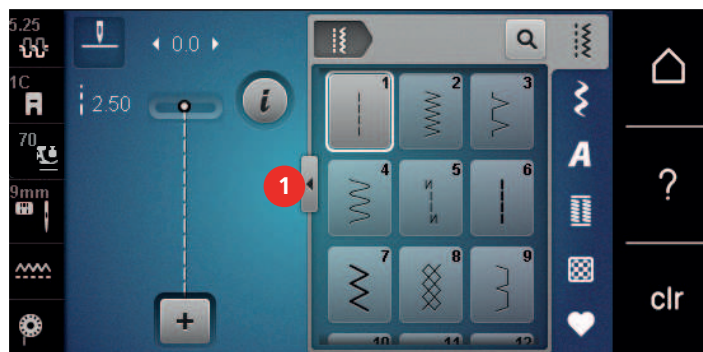

- > Touch the icon «Stitch pattern number entry» to select the stitch pattern via entering the stitch number.

5.2 BERNINA Dual Feed



It is recommended to match the presser foot pressure with the fabric. The thicker the fabric, the lower the presser foot pressure.

The BERNINA Dual Feed feeds the fabric from above and from beneath simultaneously. This provides an even and careful feed forward even for smooth and thin materials. Striped and checkered patterns can be matched perfectly by even feeding.

In general, the BERNINA Dual Feed is used for the following sewing projects:

- Sewing: All sewing applications with difficult fabrics such as for seams, zippers.
- Patchwork: With accurate stripes, blocks and with decorative stitches up to a stitch width of 9 mm.
- Appliqués: Sewing on ribbons and bias binding.

Difficult-to-work-with fabrics are:

- Velvet, normally sewn with the grain.
- Toweling.
- Jersey, especially when sewing it crosswise to knit.
- Fake fur or coated fake fur.
- Fleece-types of fabrics.
- Batted fabrics.
- Stripes and checks.
- Curtain fabrics with pattern repeats.

«Sticky» fabrics are:

- Imitation leather, coated fabrics (optimally with optional accessory Zigzag foot # 52D with sliding sole).

Application of the BERNINA Dual Feed



Only use presser feet with a cut-out at the center back and the labeling «D». Additional presser feet with the labeling «D» are listed in the enclosed accessory catalog.

Activate Dual Feed

- > Raise the presser foot.
- > Attach a presser foot with the designation «D».
- > Pull the dual feed down until it engages.



Deactivate Dual Feed

- > Raise the presser foot.
- > Hold the dual feed by the handle with two fingers, pull it down and then push it away from you and let it slide slowly upwards.



5.3 Regulating the speed

The sewing speed can be adjusted infinitely variable with the slide.

- > Move the slide to the left to reduce the sewing speed.
- > Move the slide to the right to increase the sewing speed.

5.4 Adjusting the upper thread tension

The basic setting of the upper thread tension is provided automatically as soon as a stitch pattern or an embroidery motif is selected.

The upper thread tension is set optimally at the BERNINA factory and the machine has been tested. Metrosene-/Seralon thread size 100/2 (Company Mettler, Switzerland) is used for upper and bobbin thread.

When of using other types of sewing or embroidery threads, the optimal tension may vary. Therefore it may be necessary to adjust the upper thread tension according to the sewing or embroidering project as well as the desired stitch pattern or the embroidery motif individually.

The higher the upper thread tension, the tighter the upper thread which means that the bobbin thread is pulled up to the top of the fabric. When the upper thread tension is low, the upper thread is less tightened which means that the bobbin thread is pulled up less.

Alterations of the upper thread tension affect the currently selected stitch pattern or embroidery motif. Permanent alterations of the upper thread tension for the sewing mode (see page 48) and for the embroidering mode (see page 53) can be made in the Setup Program.

Prerequisite:

- In the Setup Program the upper thread tension has been altered.
- > Touch the icon «Upper thread tension».
- > Move the slide using the touchscreen pen/finger to increase or reduce the upper thread tension.



- > Touch the yellow-framed icon on the right side to reset the alteration to default setting.
- > Touch the yellow-framed icon on the left side to reset the alteration to default setting in the **Setup Program**.

5.5 Editing stitch patterns

Changing the stitch width

- > Turn the «Upper Multifunction knob» to the left to narrow the stitch width.
- > Turn the «Upper Multifunction knob» to the right to widen the stitch width.
- > To call up further setting options, touch the icon «Stitch width» (1).

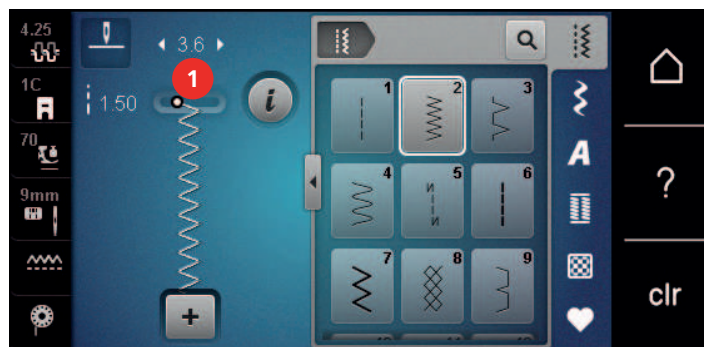

Changing the stitch length

- > Turn the «Lower Multifunction knob» to the left to shorten the stitch length.
- > Turn the «Lower Multifunction knob» to the right to elongate the stitch length.
- > To call up further setting options, touch the icon «Stitch length» (1).

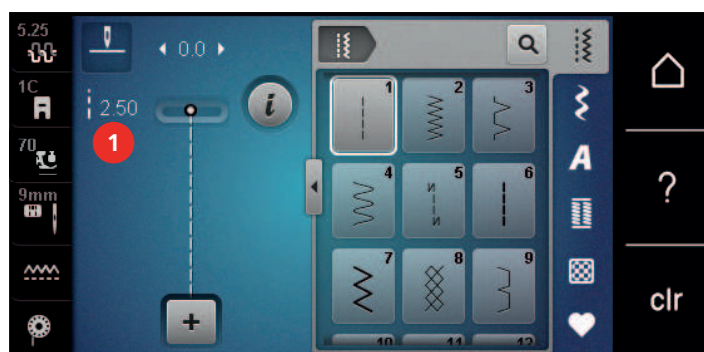

Correcting the balance

Different fabrics, threads and stabilizers can affect the programmed stitch patterns so that they cannot be sewn out correctly. The electronic balance can correct these deviation and the stitch pattern can be adjusted optimally to the selected fabric.

- > Select a stitch pattern or alphabet.
- > Sewing stitch pattern.
- > Touch the icon «i»-Dialog.





- > Touch the icon «Confirm».
- A preview of the stitch pattern is displayed.

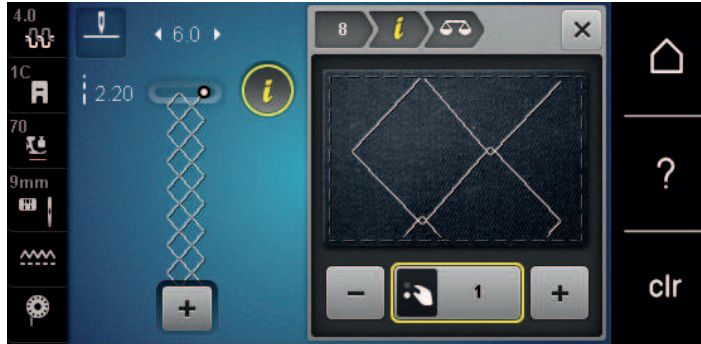

- > To correct the longitudinal direction of the stitch pattern, turn the «Lower Multifunction knob» until the preview of the stitch pattern matches the stitch pattern sewn on the fabric.
- > Altered balance settings can be saved for each stitch in the «Personal memory».
- > Altered balance settings only remain valid until the «clr button» is pressed or the machine is switched off.

Programming pattern repeat

Stitch patterns can be repeated up to 99 times.

- > Select a stitch pattern or alphabet.
- > Touch the icon «i»-Dialog.



- > Touch the icon «Pattern repeat».
- A new display appears.
- > Enter the desired number of stitch patterns.



- > Touch the icon «Confirm».

Programming long stitch

The maximum length for long stitches is 12 mm and the machine sews every second stitch.

- > Select a stitch pattern.
- > Touch the icon «i»-Dialog.

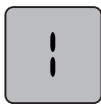

- > Touch the icon «Long stitch».

Mirror image of stitch patterns

- > Select a stitch pattern or alphabet.
- > Touch the icon «i»-Dialog.



- > Touch the icon «Mirror image left/right» to mirror the stitch pattern from left to right.



- > Touch the icon «Mirror image up/down» to mirror the stitch pattern contrary to the sewing direction.



Editing stitch pattern length

The stitch patterns can be lengthwise extended or shortened.

- > Select a stitch pattern or alphabet.
- > Touch the icon «i»-Dialog.



- > Touch the icon «Editing stitch pattern length».
- > Move the slide with the touchscreen pen/finger to determine the length of the stitch pattern.
- > Touch the icon «+100%» (1) to extend the stitch pattern length in 100%-steps.



Programming the stitch counter function

The stitch counter function cannot be applied with all stitch patterns. If, for example, the honeycomb stitch has been selected, the stitch counter function cannot be used.

- > Select a stitch pattern.
- > Touch the icon «i»-Dialog.



- > Touch the icon «Program the length with the stitch counter».
- > Sew the desired length.

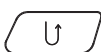

- > Push the button «Quick reverse».
 - The display changes to «Auto» and the selected stitch pattern in the new length is saved until the machine is switched off.

Sewing stitch patterns using the triple stitch

To achieve a more beautiful effect, stitch patterns can be sewn triply. The triple stitch doesn't work with all the stitch patterns.

- > Select a stitch pattern.
- > Touch the icon «i»-Dialog.



- > Touch the icon «Triple stitch».

Quick reverse

- > Select a stitch pattern, alphabet or buttonhole.
- > Program needle stop down (permanent) to switch immediately to Quick reverse as soon as the button «Quick reverse» is pressed.
- > Program needle stop up (permanent) to sew another stitch forward before the machine switches to reverse sewing.

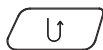

- > Push the button «Quick reverse» and keep pressed.

Permanent Quick reverse

- > Select a stitch pattern or alphabet.
- > Touch the icon «i»-Dialog.

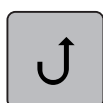

- > Touch the icon «Permanent reverse sewing» to sew permanently in reverse.
 - The machine keeps sewing in reverse until the icon «Permanent reverse sewing» is touched again.

Backstepping

- > Select a stitch pattern or alphabet.
- > Touch the icon «i»-Dialog.



- > Touch the icon «Backstepping» to backstep the last 200 stitches.

5.6 Combining stitch patterns

Overview Combi mode



- | | | | |
|---|--|---|--|
| 1 | Stitch width of the active stitch pattern | 3 | Combination mode/single mode |
| 2 | Stitch length of the active stitch pattern | 4 | Individual stitch pattern within the combination |

Creating Stitch pattern combinations

In the Combi mode stitch patterns and alphabets can be combined according to your wish. By combining any alphabet letters, the logo BERNINA can be created.



- > Touch the icon «Single/Combi mode».

- > Select the desired stitch patterns.



- > Touch the icon «Single/Combi mode» again to return to the single mode.

Saving a stitch pattern combination

To be able to use individually created stitch pattern combinations, they can be saved in «Personal Memory».

- > Create a stitch pattern combination.
- > Touch the icon «Personal memory».



- > Touch the icon «Save stitch pattern».



- > Touch the icon «Confirm» or the yellow-framed icon to save the stitch pattern combination.

Loading a stitch pattern combination



- > Touch the icon «Single/Combi mode».



- > Touch the icon «Personal memory».



- > > Touch the icon «Selection of stitch pattern combination».
- > Select a stitch pattern combination.

Overwriting a stitch pattern combination

- > Create a stitch pattern combination.
- > Touch the icon «Personal memory».



- > Touch the icon «Save stitch pattern».
- > Select the stitch pattern combination which is to be overwritten.



- > Touch the icon «Confirm» to overwrite the stitch pattern combination.

Deleting a stitch pattern combination

- > Create a stitch pattern combination.
- > Touch the icon «i»-Dialog.





> Touch the icon «Edit the whole combination».



> Touch the icon «Delete».



> Touch the icon «Confirm».

Editing a single stitch pattern

- > Create a stitch pattern combination.
- > With the touchscreen pen/finger touch the desired position (1) within the stitch pattern combination to select a single stitch pattern.



> Touch the icon «i»-Dialog to edit the single stitch pattern.

Deleting a single stitch pattern

- > Create a stitch pattern combination.
- > Use the touchscreen pen/your finger to touch the required position (1) in the stitch pattern combination in order to select an individual stitch pattern.



> Touch the icon «i»-Dialog.



> Touch the icon «Delete» to delete the individual stitch pattern.

or

- > Use the touchscreen pen/your finger to touch the required stitch pattern (1) in the stitch pattern combination, hold this down and slide the stitch pattern outwards.
 - The stitch pattern is deleted.

Adding a single stitch pattern

The new stitch pattern is always inserted **after** the selected stitch pattern.

- > Create a stitch pattern combination.
- > With the touchscreen pen/finger touch the desired position (1) within the stitch pattern combination to select a single stitch pattern.



- > Select a new stitch pattern.

Adapting the stitch pattern length and stitch pattern width

The length and width of the individual stitch patterns in a stitch pattern combination can be adapted to the longest and widest stitch patterns in the combination.

- > Create a stitch pattern combination.
- > Touch the icon «i»-Dialog.



- > Touch the icon «Edit the complete combination».



- > Touch the icon «Total pattern length» (1).
- > Touch the icon «Adapt the length within the combination» (2).
 - The lengths of the stitch patterns are adapted to the length of the longest stitch pattern in the combination



- > Touch the icon «Stitch width» (3).
- > Touch the icon «Adapt the width within the combination» (4).
 - The widths of all of the stitch patterns are adapted to the width of the widest stitch pattern in the combination

Furthermore, the length and width of the stitch pattern combination are increased or decreased proportionally.

- > To decrease the width of the stitch pattern combination proportionally, turn the «Upper multifunction knob» anti-clockwise.
- > To increase the width of the stitch pattern combination proportionally, turn the «Upper multifunction knob» clockwise.
- > To decrease the length of the stitch pattern combination proportionally, turn the «Lower multifunction knob» anti-clockwise.
- > To increase the length of the stitch pattern combination proportionally, turn the «Lower multifunction knob» clockwise.

Mirroring a stitch pattern combination



- > Create a stitch pattern combination.
- > Touch the icon «i»-Dialog.

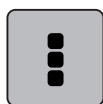

- > Touch the icon «Edit the whole combination».



- > Touch the icon «Mirror image left/right» to mirror the whole stitch pattern combination from the left to the right.
- > Touch the icon «Mirror image left/right» again to reset the alterations to default setting.

Stitch pattern combination Subdivider 1

A stitch pattern combination can be subdivided into several sections. The subdivision is placed **beneath** the cursor. Only this section is sewn where the cursor is placed. To sew the next section, the cursor must be placed in the next section.

- > Create a stitch pattern combination.
- > With the touchscreen pen/finger select the desired position within the stitch pattern combination where the stitch pattern combination is to be subdivided.
- > Touch the icon «i»-Dialog.

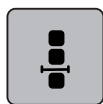

- > Touch the icon «Edit combination at cursor position».

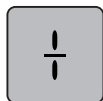

- > Touch the icon «Combination subdivider».

Stitch pattern combination Subdivider 2

A stitch pattern combination can be interrupted at several positions. The interruption is placed **beneath** the cursor.

- > Create a stitch pattern combination.



- > With the touchscreen pen/finger select the desired position within the stitch pattern combination where the stitch pattern combination is to be interrupted.
- > Touch the icon «i»-Dialog.

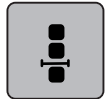

- > Touch the icon «Edit combination at cursor position».

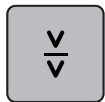

- > Touch the icon «Combination subdivider 2».
- > Sew the first section and then reposition the fabric.

Securing a stitch pattern combination



- > Create a stitch pattern combination.
- > With the touchscreen pen/finger select the desired position within the stitch pattern combination where the stitch pattern combination is to be secured.
- > Touch the icon «i»-Dialog.

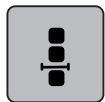

- > Touch the icon «Edit combination at cursor position».



- > Touch the icon «Securing».
 - Every single pattern of the stitch pattern combination can be secured at the start or at the end.

Programming pattern repeat



- > Create a stitch pattern combination.
- > Touch the icon «i»-Dialog.

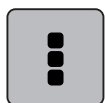

- > Touch the icon «Edit the complete combination».



- > Touch the icon «Pattern repeat» once to repeat the stitch pattern combination.
- > Touch the icon «Pattern repeat» again to repeat the stitch pattern combination up to 9 times.
- > To deactivate the pattern repeat, keep the icon «Pattern repeat» pressed or touch the icon «clr».

5.7 Administering stitch patterns

Saving settings of stitch patterns



- > Select a stitch pattern, alphabet or buttonhole.
- > Touch the icon «i»-Dialog.
- > Edit the stitch, alphabet or buttonhole.



- > Touch the icon «Saving stitch pattern settings» to save the alterations permanently.



- > Touch the icon «Back to default setting» to cancel the alterations.

Saving stitch patterns in personal memory

In the filing system «Personal memory» any stitch patterns, also those which have been individually edited, can be saved.

- > Select a stitch pattern, alphabet or buttonhole.
- > Edit the stitch pattern.
- > Touch the icon «Personal memory».



- > Touch the icon «Save stitch pattern».
- > Select the file where the pattern is to be saved.



- > Touch the icon «Confirm».

Overwriting stitch patterns from the personal memory

Prerequisite:

- The stitch pattern is saved in the personal memory.
- > Select a stitch pattern, alphabet or buttonhole.
- > Edit the stitch pattern.
- > Touch the icon «Personal memory».



- > Touch the icon «Save stitch pattern».
- > Select the file where the stitch pattern to be overwritten has been saved.
- > Select the stitch pattern which should be overwritten.
- > Touch the icon «Confirm».



Loading stitch patterns from the personal memory

Prerequisite:

- The stitch pattern is saved in the personal memory.
- > Touch the icon «Personal memory».





- > Touch the icon «Load embroidery motif».
- > Select the file where the stitch pattern has been saved.
- > Select a stitch pattern.

Deleting stitch patterns from the personal memory

Prerequisite:

- The stitch pattern is saved in the personal memory.
- > Touch the icon «Personal memory».



-  > Touch the icon «Delete».
- > Select the file where the stitch pattern has been saved.
- > Select a stitch pattern.
-  > Touch the icon «Confirm» to delete the stitch pattern.

Saving stitch patterns on the BERNINA USB stick

On the BERNINA USB stick stitch patterns, also those which have been individually edited, can be saved.

- > Select a stitch pattern, alphabet or buttonhole.
- > Edit the stitch pattern.
- > Touch the icon «Personal memory».



-  > Touch the icon «Save stitch pattern».
- > Insert the BERNINA USB stick into the USB port of the machine.
-  > Touch the icon «USB Stick».
-  > Touch the icon «Confirm».

Uploading a stitch pattern from the BERNINA USB stick

- > Touch the icon «Personal memory».



-  > Touch the icon «Load stitch pattern».
- > Touch the icon (1).

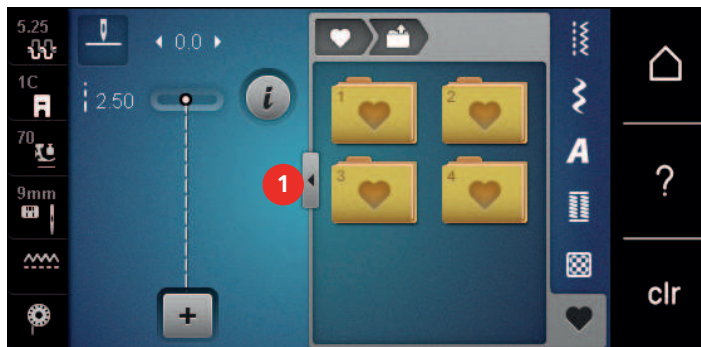



-  > Insert the BERNINA USB stick into the USB port of the machine.
- > Touch the icon «USB stick».
- > Select the desired stitch pattern.

Deleting stitch patterns from the BERNINA USB stick

- > Touch the icon «Personal memory».



-  > Touch the icon «Delete».
- > Insert the BERNINA USB stick into the USB port of the machine.
- > Select the stitch pattern which is to be deleted.
-  > Touch the icon «Confirm».

5.8 Securing

Securing via the icon «Securing»

Every single pattern of a stitch pattern combination can be secured either at the beginning or at the end.



- > Touch the icon «i»-Dialog.



- > Touch the icon «Securing» before starting to sew.
 - The stitch pattern/stitch pattern combination is secured with 4 stitches at the beginning.
- > Touch the icon «Securing» while sewing.
 - The stitch pattern or the active stitch pattern of the stitch pattern combination is secured with 4 stitches at the end.

Securing with the button «Pattern end»

The button «Pattern end» can be programmed with various functions.



- > Push the button «Pattern end» before sewing is started or while sewing.
 - While sewing, a stop icon indicates that the function is activated and the stitch pattern or the current combination of a stitch pattern will be secured at the end with the programmed number of stitches.

5.9 Height Compensation of uneven layers

If the presser foot is at an angle when sewing over a thick seam, the feed dog cannot grip the fabric and the sewing project cannot be sewn out properly.

- > Place 1 – 3 compensating plates as required from the back of the presser foot close to the needle to level the fabric layer.

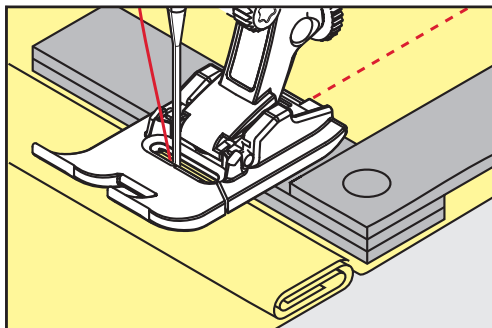

- The presser foot is leveled with the sewing project.

- > Place 1 – 3 compensating plates as required from the front of the presser foot close to the needle to level the fabric layer.

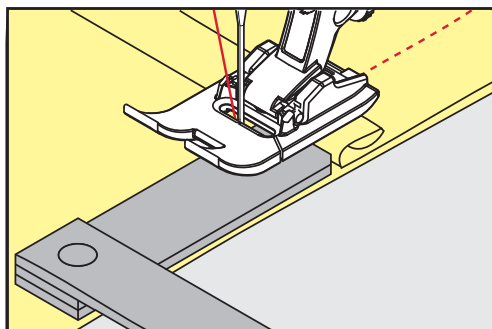









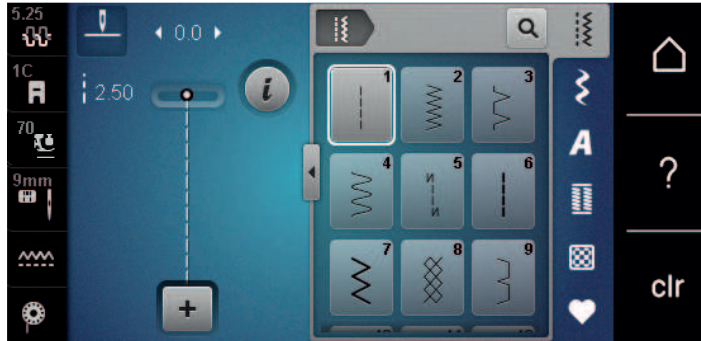



- The presser foot is leveled with the sewing project.

















- > Sew until the complete presser foot has passed the thick seam.
- > Remove the plates of the height compensation.

6 Practical stitches

6.1 Overview Practical stitches



Stitch pattern	Stitch number	Name	Description
	1	Straight stitch	Sew together and top-stitch.
	2	Zigzag	Reinforcing seams, overcasting edges, sewing elastic seams and attaching lace.
	3	Vari-Overlock	Sewing and finishing in one step of elastic fabrics.
	4	Running stitch	Darning with running stitch, mending fabrics, reinforcing edges.
	5	Securing program	Securing starts and ends of seams by straight stitching.
	6	Triple Straight stitch	Reinforced seams in heavy fabrics; visible hems and seams.
	7	Triple Zig zag	Reinforced seams in heavy fabrics; visible hems and seams.
	8	Honeycomb stitch	For stretch fabrics and hems. Is also used with elastic thread in the bobbin.
	9	Blind stitch	Blind hems, shell edging effect on soft jerseys and fine material, decorative seams.
	10	Double overlock	Sewing and finishing in one step of elastic fabrics.
	11	Superstretch stitch	For highly stretch fabrics. For all types of clothing.
	12	Gathering stitch	Most types of fabric; gathering with elastic, butted seams = butting two pressed edges and sewing together, decorative stitches.

Stitch pattern	Stitch number	Name	Description
	13	Stretch overlock	Sewing and finishing in one step of elastic fabrics.
	14	Tricot stitch	Visible hems, visible seams in lingerie, sweaters, mending jersey.
	15	Universal stitch	For firm fabrics such as felt and leather. Flat joining seams, visible seams, attaching elastic, decorative seams.
	16	Sewn-out Zig zag	Edge finishing and reinforcing, attaching elastic, decorative seam.
	17	Lycra stitch	For lycra fabrics; flat joining seams and hems, reinforced seaming on underwear.
	18	Stretch stitch	For highly stretch fabrics; open seam for sportswear.
	19	Reinforced overlock	Medium-weight knits and toweling. Overlock seam or flat joining seam.
	20	Knit overlock	Sewing and finishing of hand- and machine-knitted fabrics in one step.
	21	Basting stitch	For seams and hems.
	22	Simple Darning Program	Darning of holes and damaged fabric.
	23	Reinforced Darning Program	Reinforcing darning holes and damaged fabric.
	24	Bartack Program	Reinforcing pocket openings, sewing belt loops.
	25	Bartack Program	Reinforcing pocket openings, sewing on belt loops, securing zippers and seam ends.
	26	Large Fly stitch	Reinforcing pocket openings, zippers and slits in medium-weight to thick fabrics.
	27	Small fly stitch	Reinforcing pocket openings, zippers and slits in fine to medium-weight fabrics.
	29	Narrow blindstitch	For blind hems in fine fabrics.
	31	Triple straight stitch with long stitch	Reinforced seams in heavy fabrics; visible hems and seams.

Stitch pattern	Stitch number	Name	Description
	32	Single Straight stitch	Used as a connecting stitch in a combination.
	33	Three simple straight stitches	As connecting stitches in a combination.
XXXX	34	Darning Stitch	For darning with a running stitch together with the function «Permanent reverse sewing».
	35	Open overlock stitch	For sewing together and, at the same time, finishing elastic fabrics with a reinforced edge.
XXXX	36	Overlock	For medium-weight knitted goods.
XXXX	37	Reinforced overlock stitch	For simultaneously sewing together, finishing and reinforcing elastic fabrics.
▼▼▼	38	Chain stitch	Decorative and reinforcing stitch for most woven fabrics.
XXXX	39	Cover stitch effect	To sew decorative seams and hems in heavy knitted goods and woven fabrics.
XXXX	40	Cover stitch effect	To sew decorative seams and hems in heavy knitted goods and woven fabrics.

6.2 Sewing straight stitch

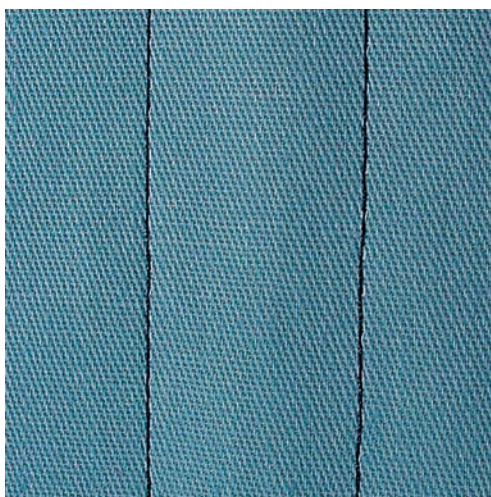

Match the stitch length with the sewing project, which means for denim fabrics long stitches (ca. 3 – 4 mm), for fine fabrics short stitches (ca. 2 – 2.5 mm). Match the stitch length with the thread size, e.g. long stitches when topstitching with Cordonnet (ca. 3 – 5 mm).



As the fabric feed can be difficult when starting to sew, it is recommended to hold the threads firmly or to pull the fabric slightly to the back for a few stitches or to sew 1 – 2 cm reverse first.



- > Attach the Reverse pattern foot No. 1C.
- > Touch the icon «Practical stitches».
- > Select the Straight stitch No. 1.
- > Sew the seam up to where the zipper starts.
- > Sew the securing stitches.
- > Close the zipper length with long stitches.
- > Finish the seam allowances.
- > Iron the seam.
- > Open the zipper length.
- > Baste the zipper under the fabric so that the fabric folded edges meet over the center of the zipper.
- > Open the zipper a few centimeters.
- > Attach the Zipper foot No. 4D.
- > Move the needle position to the right.
- > Use the Free Hand System to raise the presser foot and to position the sewing project.
- > Start sewing from top left.
- > Guide the foot so that the needle stitches along the zipper coils.
- > Stop in front of the zipper pull with needle position down.
- > Raise the presser foot.
- > Close the zipper.
- > Continue to sew and stop in front of the base of the zipper with needle position down.
- > Raise the presser foot and turn the sewing project.
- > Sew across the other side of the zipper and stop with needle position down.
- > Raise the presser foot and turn the sewing project.
- > Sew the second side from bottom to top.

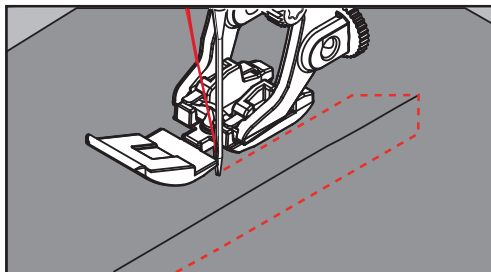

6.5 Sewing both sides of the zipper from bottom to top

For fabrics with pile, such as velvet, it is recommended to sew in the zipper on both sides from bottom to top.



When the fabric is densely woven or hard, it is recommended to use a needle with the size 90 – 100. This results in an even stitch formation.



- > Attach the Reverse pattern foot No. 1C.
- > Touch the icon «Practical stitches».
- > Select the Straight stitch No. 1.
- > Sew the seam up to where the zipper starts.
- > Sew the securing stitches.
- > Close the zipper length with long stitches.
- > Finish the seam allowances.
- > Iron the seam.
- > Open the zipper length.
- > Baste the zipper under the fabric so that the fabric folded edges meet over the center of the zipper.

- > Attach the Zipper foot No. 4D.
- > Move the needle position to the right.
- > Use the Free Hand System to raise the presser foot and to position the sewing project.
- > Start sewing in the center of the seam at the end of the zipper.
- > Sew diagonally along the edge of the zipper coils.
- > Sew the first side (1) from bottom to top.
- > Stop in front of the zipper pull with needle position down.
- > Raise the presser foot.
- > Open the zipper as far as behind the presser foot.
- > Lower the presser foot and continue sewing.
- > Move the needle position to the left.
- > Sew the second side (2) in exactly the same way from bottom to top.

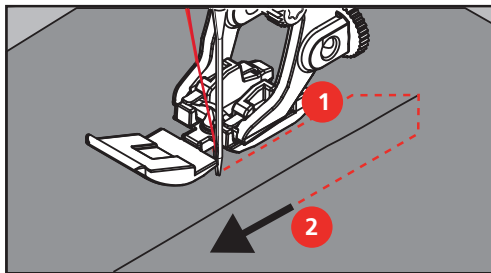

6.6 Sewing triple straight stitch



The triple straight stitch is especially suitable for durable seams and for firm, densely woven fabrics such as denim and corduroy. For firm or densely woven materials it is recommended to attach the Jeans foot No. 8. This will help to sew denim or canvas. For decorative topstitching the stitch length can be elongated.

- > Attach the Reverse pattern foot No. 1C/1D.
- > Touch the icon «Practical stitches».
- > Select the Triple straight stitch No. 6.



6.7 Sewing Triple zig zag

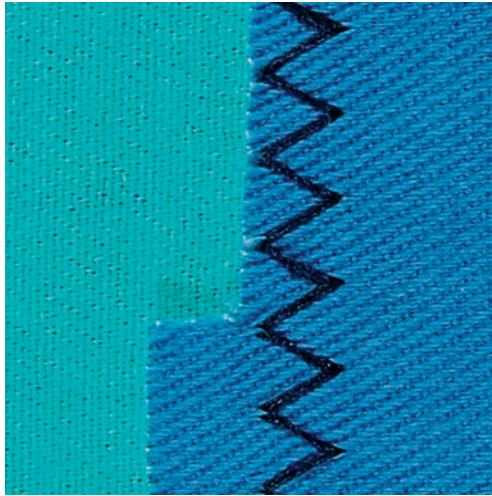

For firm materials such as denim, deckchair covers, awnings or frequently washed items. Finish raw edges first.



- > Attach the Reverse pattern foot No. 1C/1D.
- > Touch the icon «Practical stitches».
- > Select the Triple zig zag No. 7.

6.8 Manual darning

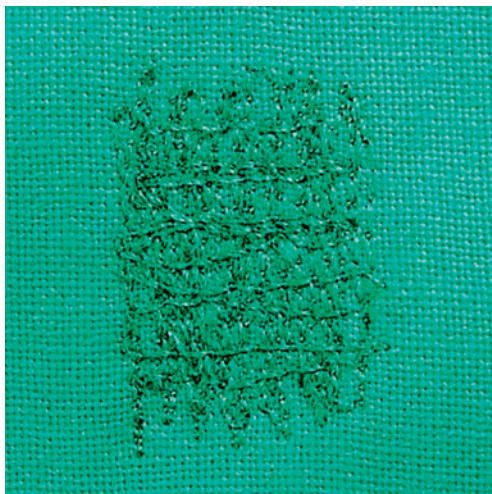

Used for darning holes or worn areas in all fabric types.

If the thread is lying on top and a poor stitch formation results, slow down the movement of the sewing project. If there are knots on the wrong side of the fabric, move the sewing project faster. When the thread breaks, guide the sewing project more consistently.



- > Attach the Darning foot No. 9 (optional accessory).
- > Touch the icon «Practical stitches».
- > Select the Straight stitch No. 1.
- > Lower the feed dog.
- > Attach the slide-on table.
- > Hoop the sewing project in the round embroidery hoop (optional accessory).
 - The area to be darned stays evenly taut and cannot be distorted.
- > Sew from the left to the right, guide the fabric evenly by hand without using pressure.
- > Move in curves when changing the direction to avoid holes and thread breakage.

- > Sew another loose row.

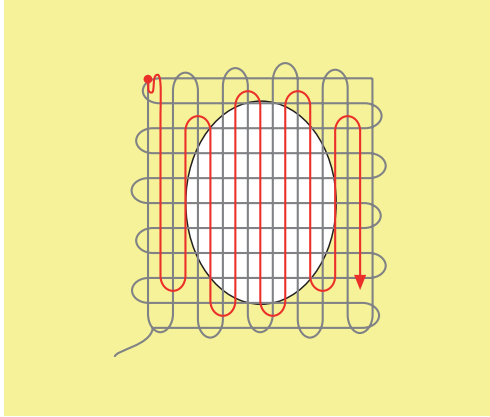

6.9 Automatic darning



The simple Darning Program No. 22 is especially suitable for quick darning of worn or damaged areas. It is recommended to use fine material as a backing for the worn and damaged areas or to stick an adhesive interlining. The simple Darning Program No. 22 replaces threads along the lengthwise grain in all materials. If the darning area becomes distorted, correct with the balance.

- > Attach the Reverse pattern foot No. 1C or the Buttonhole foot No. 3A.
- > Touch the icon «Practical stitches».
- > Select the simple Darning Program No. 22.
- > Hoop light-weight materials in the round embroidery hoop (optional accessory).
 - The darning area stays evenly taut and cannot be distorted.
- > Start sewing top left.
- > Sew the first row.
- > Stop the machine.
- > Push the button «Quick reverse».
 - The length is programmed.
- > Finish sewing the Darning Program.
 - The machine stops automatically.

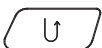

6.10 Reinforced darning, automatic

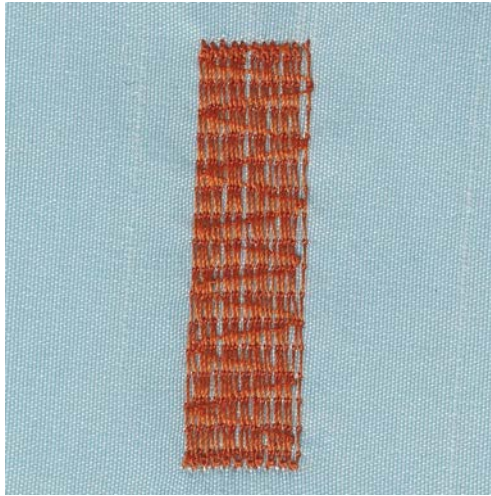

The reinforced Darning Program No. 23 is especially suitable for quick darning of thin areas or snags. The reinforced Darning Program No. 23 replaces longitudinal threads in all fabrics.



If the Darning Program does not cover the whole worn or damaged area, it is recommended to reposition the work and sew the Darning Program again. The length is programmed and can be repeated as often as desired.



- > Attach the Buttonhole foot No. 3A.
- > Touch the icon «Practical stitches».
- > Select the reinforced Darning Program No. 23.
- > Hoop light-weight materials in the round embroidery hoop (optional accessory).
 - The darning area stays evenly taut and cannot be distorted.
- > Start sewing top left.
- > Sew the first row.
- > Stop the machine.

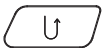

- > Push the button «Quick reverse».
 - The darning length is programmed.
- > Finish sewing the Darning Program.
 - The machine stops automatically.

6.11 Reinforced Darning Program

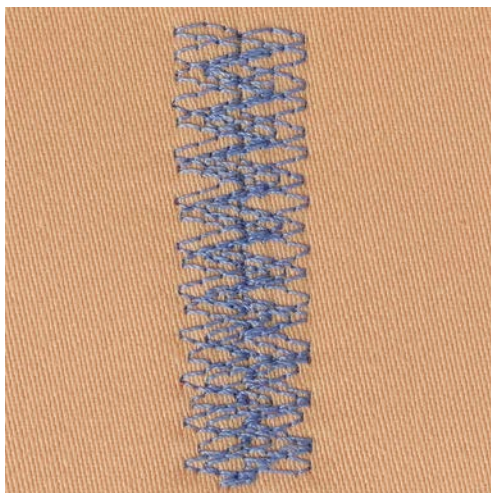

The Darning Program No. 34 is particularly suitable for worn or damaged area in heavy or firm fabrics such as denim or overalls.

- > Attach the Reverse pattern foot No. 1C.
- > Touch the icon «Practical stitches».
- > Select the reinforced Darning Program No. 34.



6.12 Finishing edges



The Zig zag No. 2 is suitable for all materials. It can also be used for elastic seams as well as for decorative sewing. Use darning thread for fine materials. When sewing satin stitch it is recommended to select a dense, short the zig zag with a stitch length of 0.3 – 0.7 mm. The satin stitch can be used for appliqué and for embroidering.

Prerequisite:

- The edge of the fabric should lie flat and not roll.
- > Attach the Reverse pattern foot No. 1C.
- > Touch the icon «Practical stitches».
- > Select the Zig zag No. 2 or the Satin stitch No. 1315.
- > Neither select too wide a stitch nor too long a stitch.
- > Guide the edge of the fabric into the center of the presser foot, so that the needle goes into the fabric on one side and over the edge into the air on the other side.



6.13 Sewing Double overlock



A double overlock seam is suitable for loose knits and cross seams in knits. When working with jersey, a jersey needle should be used to prevent damaging the knit fabric. When sewing stretch materials, use a stretch needle.

- > Attach the Reverse pattern foot No. 1C or the Overlock foot No. 2A.
- > Touch the icon «Practical stitches».
- > Select the Double overlock No. 10.



6.14 Narrow edgestitching

- > Attach the Blindstitch foot No. 5 or the Reverse pattern foot No. 1C or the Edge stitch foot No. 10/10C/10D (optional accessory).
- > Touch the icon «Practical stitches».
- > Select the Straight stitch No. 1.
- > Place the edge on the left against the guide of the Blindstitch foot.
- > Select the needle position left at the desired distance to the edge.

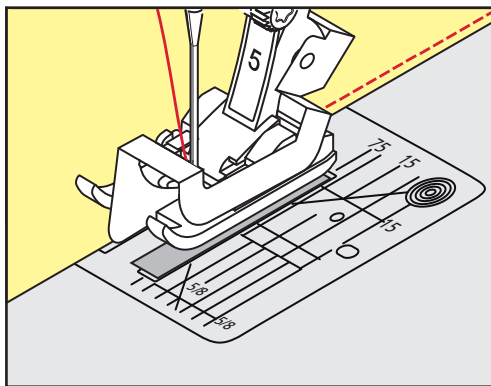

6.15 Wide edgestitching

- > Attach the Blindstitch foot No. 5 or the Reverse pattern foot No. 1C or the Edge stitch foot No. 10/10C/10D (optional accessory).
- > Touch the icon «Practical stitches».
- > Select the Straight stitch No. 1.
- > Guide the edge along the presser foot or at a distance of 1 – 2.5 cm (0.39 – 0.98 inch) along the marks.
- > Select the needle position in the desired distance to the edge.

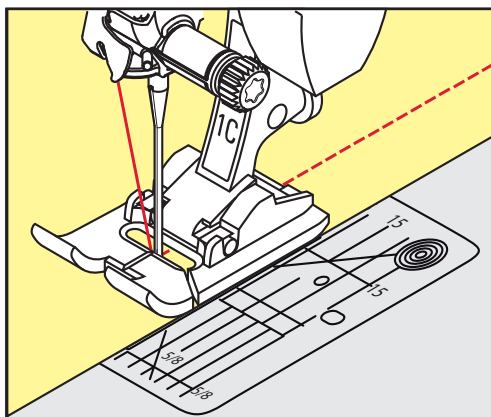

6.16 Edgestitching using the seam guide (optional accessory)

When sewing parallel wider lines, it is recommended to guide the seam guide (optional accessory) along a sewn line.



- > Attach the Reverse pattern foot No. 1C or the Edge stitch foot No. 10/10C/10D (optional accessory).
- > Touch the icon «Practical stitches».
- > Select the Straight stitch No. 1.
- > Loosen the screw on the back of the presser foot.
- > Insert the seam guide into the hole of the presser foot.
- > Adjust the width as desired.
- > Tighten the screw.
- > Guide the folded edge along the seam guide.

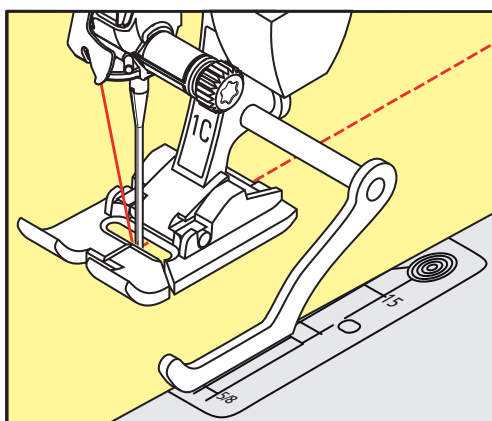

6.17 Sewing hem edges

When using the Blindstitch foot No. 5, it is recommended to select a needle position far left or far right. When using the Reverse pattern foot No. 1C or the Edge stitch foot No. 10/10C/10D all needle positions are possible.



- > Attach the Blindstitch foot No. 5 or the Reverse pattern foot No. 1C or the Edge stitch foot No. 10/10C/10D (optional accessory).
- > Touch the icon «Practical stitches».
- > Select the Straight stitch No. 1.
- > Place the inside upper edge right against the guide of the Blindstitch foot.
- > Select the needle position far right to sew along the upper edge.

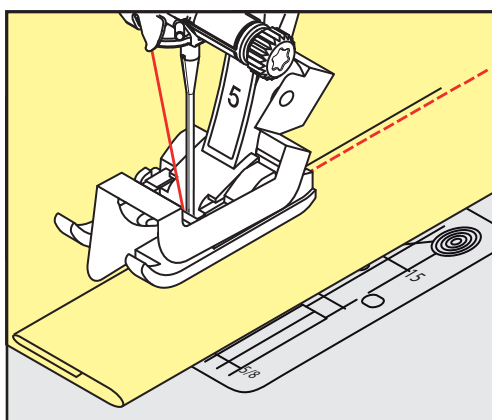

6.19 Sewing visible hems



The visible hem is especially suitable for elastic hems in jersey, cotton, wool, synthetic and mixed fibers.



- > Attach the Reverse pattern foot No. 1C/1D.
- > Touch the icon «Practical stitches».
- > Select Tricot stitch No. 14.
- > Iron the hem and baste if necessary.
- > Reduce the presser foot pressure if necessary.
- > Sew the hem at the preferred depth on the right side.
- > Trim the excess fabric from the wrong side.

6.20 Sewing flat joining seams

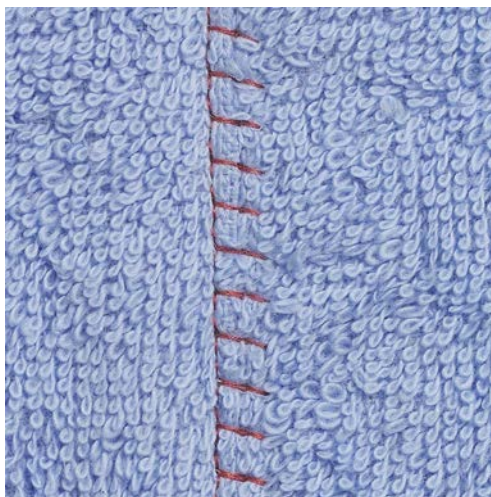

The flat joining seam is especially suitable for or thick materials such as terry cloth, felt and leather.



- > Attach the Reverse pattern foot No. 1C.
- > Touch the icon «Practical stitches».
- > Select the Stretch overlock No. 13.
- > Overlap the fabric edges.
- > Sew along the fabric edge.
- > The needle stitches over the edge of the top layer on the right side into the bottom layer to get a very flat durable seam.

7 Decorative stitches



7.1 Overview Decorative Stitches

Easier or more difficult decorative stitches come into their own depending on the type of fabric.

- Decorative stitches which are programmed with simple straight stitches are particularly appropriate for light-weight materials, e.g. the Decorative stitch No. 101.
- Decorative stitches which are programmed with triple straight stitches or with a few satin stitches are particularly appropriate for medium-weight materials, e.g. Decorative stitch No. 107.
- Decorative stitches which are programmed with satin stitches are particularly appropriate for heavy-weight materials, e.g. Decorative stitch No. 401.

For a perfect stitch formation it is of advantage to use the same thread color for upper and bobbin thread and a stabilizer. With pile or longfiber materials, it is recommended to use an additional, water-soluble stabilizer on the right side, which can be easily removed after sewing.



Decorative stitch	Category	Name
	Category 100	Natural stitches
	Category 300	Cross stitches
	Category 400	Satin stitches
	Category 600	Ornamental stitches
	Category 700	Heirloom stitches
	Category 900	Novelty
	Category 1100	Special stitches
	Category 1700	International
	Category 2000	Seasons

Decorative stitch	Category	Name
	Category 2200	Hobbies and sport

7.2 Bobbin-Play

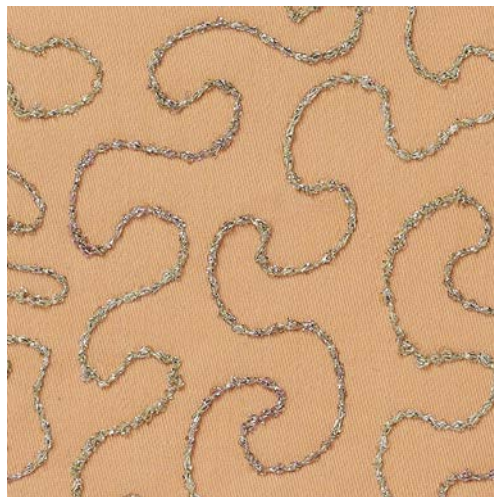

The bobbin can be filled with different thread material. For free-motion stitching to add texture. This method is similar to «normal» free-motion sewing, but is done on the **wrong** side of the fabric.

Reinforce the area to be sewn with embroidery stabilizer. The design can be drawn on the wrong side of the fabric. You can also draw the design on the front side of the fabric. The lines can be followed with a freely guided straight stitch using polyester, cotton or rayon thread. The rows of stitching are visible on the right side of the fabric, and serve as reference lines for the bobbin-thread sewing.

The BSR function can be used for bobbin-thread sewing. It is recommended to guide your project at consistent speed evenly under the needle, following the lines of the design. The stabilizer must be removed after sewing.

Sew a sample first to check what the result looks like on the wrong side of the fabric.

Not all decorative stitches are suitable for this technique. Simple decorative stitches provide best results. Avoid compact stitch types and satin stitches.

NOTICE

Inappropriate bobbin case is used

Damage of the bobbin case.

> Use the Bobbinwork bobbin (optional accessory).

> Attach the Embroidery foot No. 20C or No. 20D (optional accessory).

> Touch the icon «Decorative stitches».

> Select an appropriate decorative stitch.

> Turn the «Upper Multifunctional knob» and the «Lower Multifunctional knob» to adjust the stitch length and the stitch width so that even when sewing with thick thread a nice stitch formation can be achieved.

> Touch the icon «i»-Dialog.

> Touch the icon «Long stitch» so that the stitch pattern is sewn less densely.

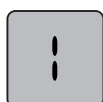



- > Touch the icon «Upper thread tension» to adjust the upper thread tension if necessary.

7.3 Altering the stitch density

With certain decorative stitches (e. g. No. 401) the stitch density can be altered. If the stitch density is increased, the stitch distance is enlarged. If the stitch density is decreased, the stitch distance is shortened. The programmed length of the stitch pattern is not affected.

- > Select the decorative stitch.
- > Touch the icon «i»-Dialog.



- > Touch the icon «Edit pattern length/stitch density».
- > Adjust the stitch density via the icons (1) «-» or «+».



7.4 Sewing cross stitches

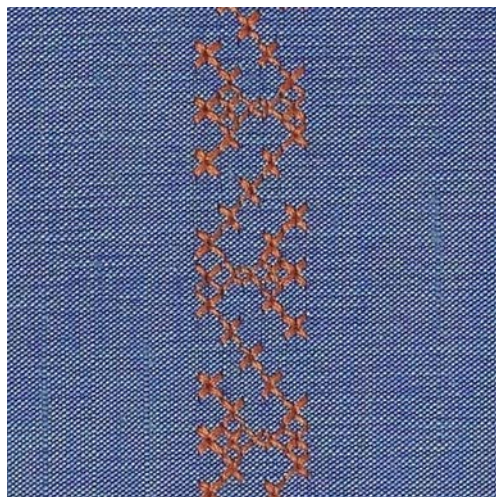

Cross stitch embroidery is a traditional technique and a charming addition to the other decorative stitches. If the cross stitches are sewn on a fabric with a linen texture, they look like hand-stitched cross stitching. When cross stitches are sewn with embroidery yarn, the stitch pattern appears fuller. Cross stitches are particularly used for home furnishing, trimmings on garments and embellishing in general. As every following line refers to the first row, it is important to stitch the first row in a straight line.

- > Fit the Reverse pattern foot No. 1C/1D or Open embroidery foot No. 20C or Embroidery foot No. 20C (optional accessory).
- > Select a cross stitch of the Kategorie 300 and combine it as desired.
- > Stitch the first row using the seam guide or slide-on table seam guide to sew a straight line.
- > Stitch the second row next to the first at a distance of one presser foot's width or using the seam guide.





7.5 Pintucks

Pintucks

The technique reduces the size of the fabric piece. It is always advisable to plan in sufficient fabric. Pintucks are narrow stitched folds, which are normally sewn on the fabric before cutting out the pieces for the garment or the sewing project. They are suitable for embellishing or in combination with other heirloom embroidery techniques.

A more distinctive and relief-like effect can be achieved when the pintucks are corded, which means that they are sewn with an additional pintuck cord. Choose a pintuck cord that fits well into the grooves of the selected pintuck foot. The cord must be colorfast and shrink-proof.

Overview pintucks

Pintuck foot	Number	Description
	# 30 (optional accessory)	3 grooves For heavy-weight fabrics. In combination with the 4 mm double needle
	# 31 (optional accessory)	5 grooves For heavy to medium-weight fabrics. In combination with the 3 mm double needle
	# 32 (optional accessory)	7 grooves For light to medium-weight fabrics. In combination with the 2 mm double needle
	# 33 (optional accessory)	9 grooves For very light fabrics (without pintuck cord). In combination with the 1 or 1.6 mm double needle
	# 46C (optional accessory)	5 grooves In combination with the 1.6 – 2.5 mm double needle For very light to medium-weight fabrics.

8 Alphabets

8.1 Overview Alphabet

Block- outline, script, quilt and comic writing, as well as Cyrillic and Cyrillic script can be sewn in two different sizes. Block- outline, script, quilt and comic writing, as well as Cyrillic and Cyrillic script can also be sewn in small letters.

For a perfect stitch formation, it is recommended to use the same thread color for upper and bobbin threads. The fabric can be reinforced with embroidery stabilizer on the wrong side. When working with pile or napped fabrics, e.g. toweling, use an additional, water-soluble stabilizer on the right side of the fabric.

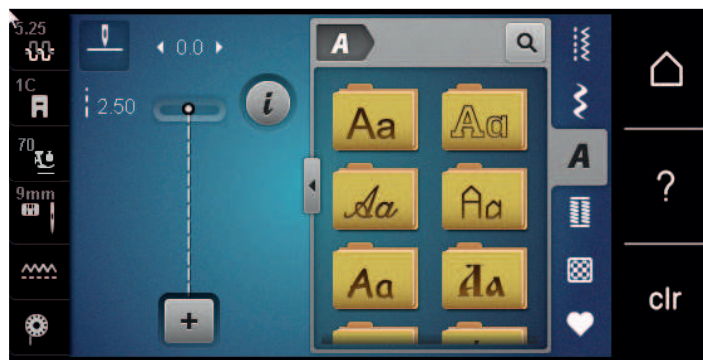

Stitch pattern	Name
ABCabc	Block alphabet
ABCabc	Double-Block
<i>ABCabc</i>	Script (Italics)
ABCabc	Quilting text
ABCabc	Comic writing
АБВабв	Cyrillic
<i>АБВ абв</i>	Cyrillic script
あいう	Hiragana
アイウ	Katakana

8.2 Creating lettering



It is recommend to sew a test sample using the desired thread, the original fabric and the original stabilizer. Please make sure that the fabric is fed evenly and lightly without colloding and being caught. Do not pull, push or hold the fabric while sewing.



- > Touch the icon «Alphabets».
- > Select the font.



- > Touch the icon «Single/Combi mode» to create a combination.
- > Touch the icon «Display alphabets» (1) to open an extended enter mode.



- > Select the letters.
- > Touch the icon (2) (standard setting) to use upper case letters.
- > Touch the icon (3) to use lower case letters.
- > Touch the icon (4) to use figures.
- > Touch the icon (5) to use special characters and mathematical symbols.



- > Touch the icon «DEL» to delete single letters of the entered text.
- > Touch the icon «Display alphabets» again to close the extended enter mode.

8.3 Altering font size

Block, Double block, Script, Quilting Text and Comic alphabets as well as Cyrillic and Script Cyrillic can be reduced in size.



- > Touch the icon «Alphabets».
- > Select the font.
- > Select the letters.



- > Touch the icon «i»-Dialog.



- > Touch the icon «Altering font size» to reduce the font size.
- > Touch the icon «Altering font size» again to scale up the font size up to 9 mm.







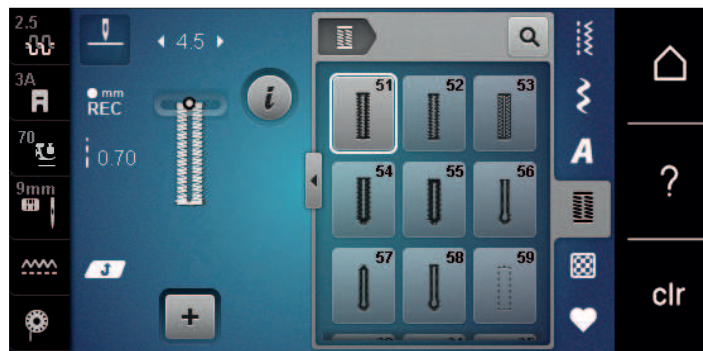



9 Buttonholes

9.1 Overview Buttonholes

To be able to create the right buttonhole for every button, every purpose and also for every garment, the BERNINA 590 comes with an extensive collection of buttonholes. The corresponding button can be sewn on automatically. Eyelets can also be sewn.



Buttonhole	Buttonhole number	Name	Description
	51	Standard buttonhole	For light to medium-weight fabrics; blouses, dresses, bedlinen.
	52	Standard buttonhole narrow	For light to medium-weight fabrics; blouses, dresses, children's and baby clothes, crafts.
	53	Stretch buttonhole	For any highly elastic jersey made from cotton, wool, silk and synthetic fibers.
	54	Round buttonhole with normal bartack	For light to medium-weight fabrics; dresses, jackets, coats, rainwear.
	55	Round Buttonhole with horizontal bartack	For medium-weight to heavy fabrics made from different fabrics: dresses, jackets, coats, rainwear.
	56	Keyhole buttonhole	For heavy-weight, non-stretch fabrics; jackets, coats, leisure wear.
	57	Keyhole buttonhole with pointed bartack	For firm, non-stretch fabrics: jackets, coats, leisure wear.
	58	Keyhole buttonhole with horizontal bartack	For firm, non-stretch fabrics: jackets, coats, leisure wear.
	59	Straight stitch buttonhole	Program for staystitching buttonholes, for pocket openings, reinforcing buttonholes, especially for buttonholes in leather and imitation leather.

Buttonhole	Buttonhole number	Name	Description
	63	Heirloom	For light to medium-weight woven fabrics; blouses, dresses, leisure wear, bedlinen.
	64	Double-rounded buttonhole	For medium-weight to heavy fabrics made from different materials.
	65	Double-rounded heirloom buttonhole	For light to medium-weight woven materials; blouses, dresses, bedlinen.
	67	Buttonhole with double pointed bartack	For medium-weight woven materials; blouses, dresses, jackets.
	68	Decorative keyhole buttonhole with horizontal bartack	For firm, non-stretch fabrics: jackets, coats, leisure wear.
	69	Decorative buttonhole with double pointed bartack	For decorative buttonholes in firmer, non-elastic fabrics.
	70	Decorative stretch buttonhole	For light to medium-weight knitted fabrics.
	60	Button sew-on program	For buttons with 2 and 4 holes.
	61	Eyelet with small zig zag	Openings for cords and narrow ribbons, for decorative work.
	62	Straight-stitch eyelet	Openings for cords and narrow ribbons, for decorative work.

9.2 Making use of the height compensation tool

When a buttonhole is to be sewn at right angles to the project edge, it is recommended to use the height compensation plates (optional accessory).

- > Place the plates from the back between the sewing project and the bottom of the slide to the thick part of the sewing project.

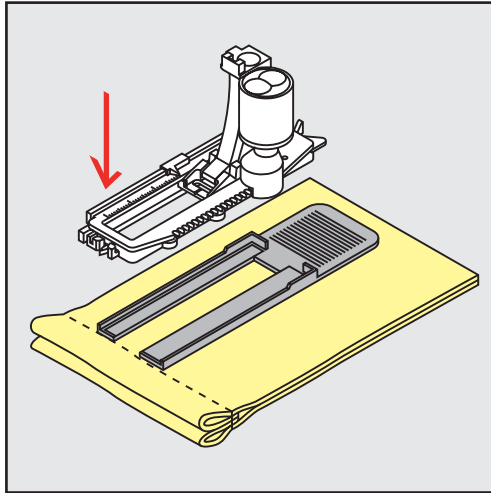

- > Lower the presser foot.

9.3 Using the compensation plate

When sewing a buttonhole in difficult materials, it is recommended to use the compensation plate for buttonholes (optional accessory). It can be used along with the Buttonhole foot No. 3A.

- > Insert the compensation plate carefully from the side.

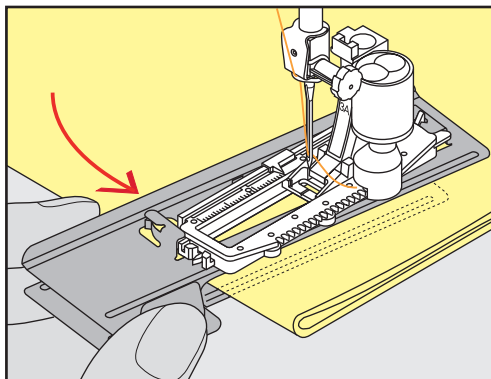

9.4 Marking buttonholes

- > For the buttonholes to be sewn manually, mark the position and the length on the fabric using chalk or a water-soluble pen.

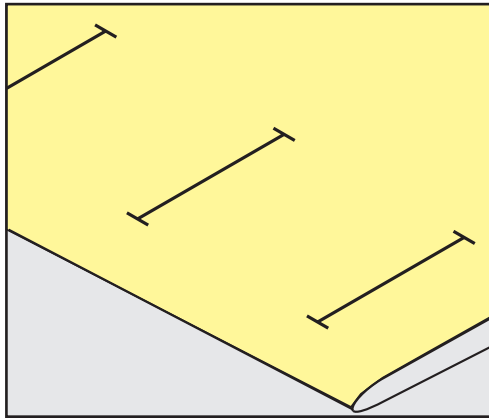

- > For the buttonholes to be sewn automatically, mark the complete length of 1 buttonhole on the fabric using chalk or a water-soluble pen. For any subsequent buttonholes mark the starting point.

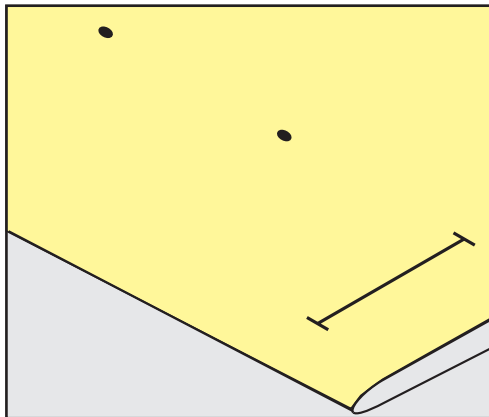

- > For keyhole and round buttonholes mark the length of the bead with chalk or a water-soluble pen on the fabric. For any subsequent buttonholes mark the starting point. The length of the keyhole is sewn additionally.

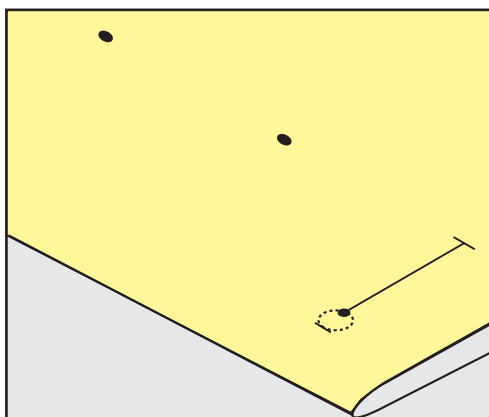

9.5 Cord

Using cord with the Buttonhole foot with slide No. 3A

Cords reinforce buttonholes and enhance their appearance and suit best for the Buttonhole No. 51. Ideal cords are Perle cotton No. 8, strong hand-sewing thread and fine crochet yarn. It is recommended to not hold the cord while sewing.

Prerequisite:

- The Buttonhole foot with slide No. 3A is attached and raised.
- > Insert the needle at the beginning of the buttonhole.
- > Guide the cord on the right side under the buttonhole foot.
- > Hook the cord over the pin at the back of the buttonhole foot.

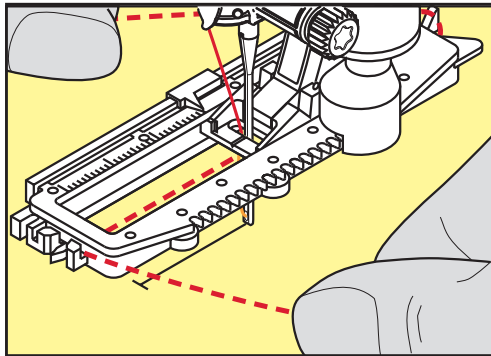

- > Pull the cord on the left side under the buttonhole foot to the front.

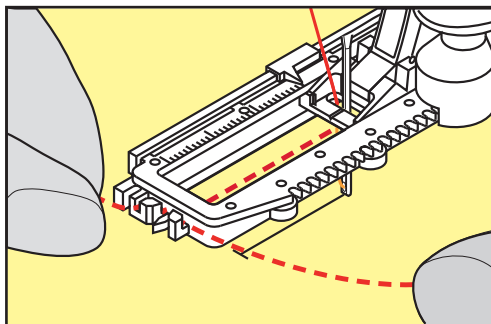

- > Pull the cord ends into the slits.
- > Lower the buttonhole foot.
- > Sew the buttonhole in the usual manner.
- > Pull the cord through the buttonhole until the loop disappears in the bartack.

- > Pull the ends of the cord through to the wrong side of the fabric (using a hand stitching-needle), knot or secure with stitches.

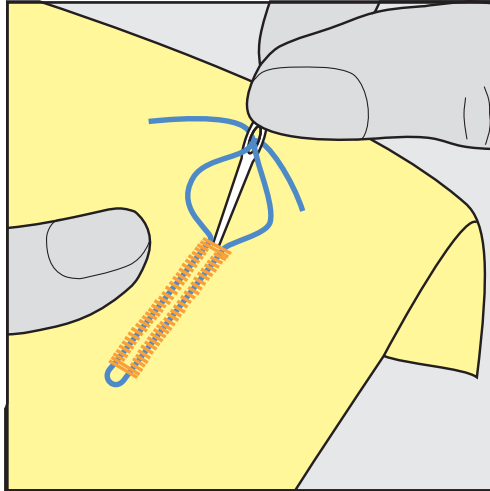

Using cord with the Buttonhole foot No. 3C (optional accessory)

Prerequisite:

- The Buttonhole foot No. 3 is attached and raised.
- > Insert the needle at the beginning of the buttonhole.
- > Hook the cord over the pin at the front of the buttonhole foot.

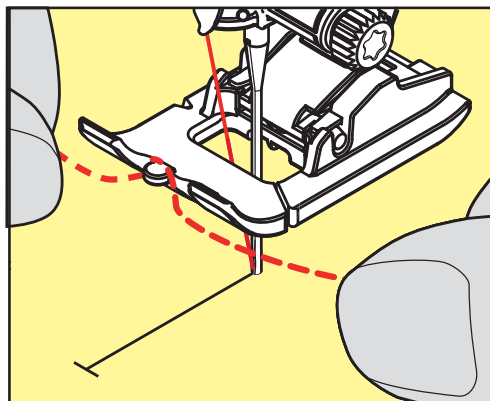

- > Pull both cords ends under the buttonhole foot to the back and place each a cord into a groove of the sole.

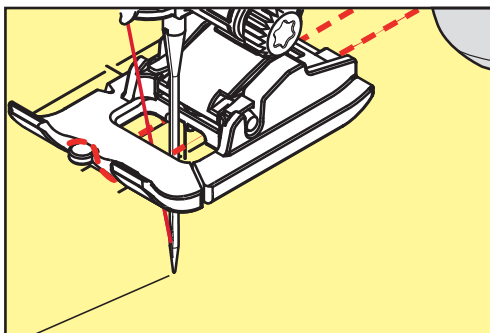

- > Lower the buttonhole foot.
- > Sew the buttonhole in the usual manner.
- > Pull the cord through the buttonhole until the loop disappears in the bartack.

- > Pull the ends of the cord through to the wrong side of the fabric using a hand stitching-needle and knot or secure with stitches.

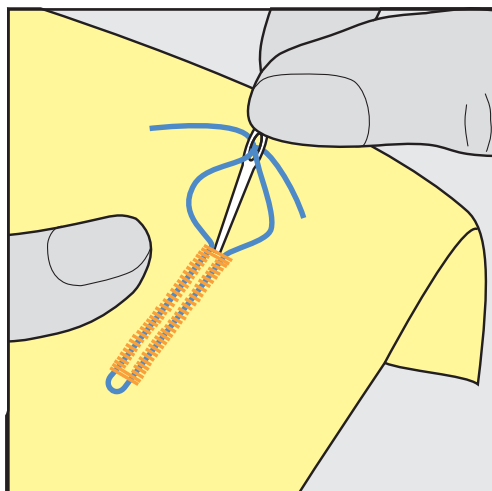

9.6 Sewing a test sample

Always sew a test sample of the buttonhole on the same fabric: It is recommended to use the same stabilizer and to select the same buttonhole. The test sample should also be sewn in the respective direction. By sewing a test sample the settings can be adjusted until the sewing result is satisfying.

When working with soft loosely woven materials or for buttonholes which are highly stressed, it is worth underlaying the buttonholes with the Straight stitch buttonhole No. 59. This is also recommended to reinforce buttonholes in leather, vinyl or felt.

Alterations of the balance when sewing a manual standard buttonhole as well as the keyhole and the round buttonhole affect both beads in the same way. With the manual keyhole or round buttonhole, the alterations affect both sides in the opposite way.

If the stitch counter function is used and alterations are made concerning the balance, the alterations affect both buttonhole beads differently.



- > Touch the icon «Buttonholes».
- > Select the buttonhole.
- > Select and attach the desired presser foot.
- > Place the fabric under the presser foot and lower the presser foot.
- > Press the foot control carefully and start sewing. Guide the fabric slightly.
- > Check the balance while sewing and adjust if necessary.
- > Check the test sample and make further amendments if necessary.

9.7 Determining the buttonhole slit width

The width of the buttonhole slit can be adjusted between 0.1 – 2.0 mm before sewing.



- > Touch the icon «Buttonholes».
- > Select the buttonhole.



- > Touch the icon «i»-Dialog.

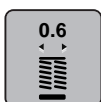

- > Touch the icon «Buttonhole slit width».
- > Turn the «Upper Multifunctional knob» or the «Lower Multifunctional knob» to adjust the buttonhole slit width as desired.

9.8 Determining the buttonhole length with the Buttonhole foot with slide No. 3A



The button can be centered in the yellow circle on the display. By turning the «Upper/Lower Multifunction knobs», the yellow circle can be enlarged or downsized to determine the diameter of the button.

Additionally to the diameter of the button, 2 mm are added automatically for the buttonhole length. If the diameter of the button is 14 mm, the buttonhole length is calculated 16 mm.

Prerequisite:

- The Buttonhole foot with slide No. 3A is attached.



- > Touch the icon «Buttonholes».
- > Select the buttonhole.



- > Touch the icon «i»-Dialog.



- > Touch the icon «Adjust the buttonhole length».
- > Turn the «Upper Multifunction knob» or the «Lower Multifunction knob» to adjust the buttonhole length.

9.9 Determining the buttonhole length with Buttonhole foot No. 3C (optional accessory)

With the Buttonhole foot No. 3C (optional accessory) the buttonhole length must be determined via the stitch counter function. The stitch counter function is suitable for all types of buttonholes. The left buttonhole bead is sewn forward, the right buttonhole bead is sewn in reverse. If alterations of the balance are made, the stitch counter function has to be saved for every buttonhole separately.

Prerequisite:

- The Buttonhole foot No. 3C (optional accessory) is attached.



- > Touch the icon «Buttonholes».
- > Select the buttonhole.



- > Touch the icon «i»-Dialog.



- > Touch the icon «Program the length with the stitch counter».
- > Sew the desired buttonhole length.
- > Stop the machine.

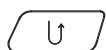

- > Push the button «Quick reverse» so that the machine sews the lower bartack and the second bead in reverse.
- > Stop the machine at the height of the first stitch.
- > Push the button «Quick Reverse» so that the machine sews the upper bartack and the securing stitches.
 - The length of the buttonhole remains saved and every subsequent buttonhole is sewn identically until the machine is switched off.

9.10 Sewing a buttonhole automatically

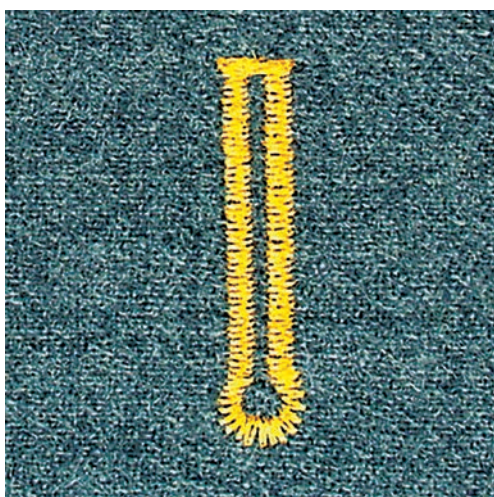
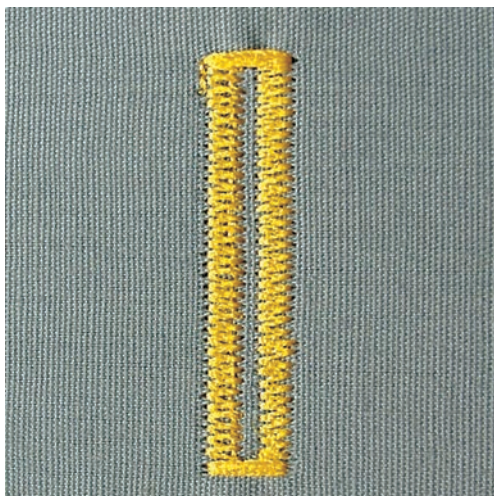

When the Buttonhole foot with slide No. 3A is used, the length of the buttonhole is measured automatically by the lens on the presser foot. The buttonhole will be duplicated and the machine switches to the next step automatically when the maximum length is reached. The Buttonhole foot with slide No. 3A is suitable for buttonholes in the length of 4 – 31 mm, depending on the buttonhole type. The slide of the Buttonhole foot must lie perfectly flat on the fabric so that the length can be measured accurately. All the programmed buttonholes are the same length and of the same nice look.

Prerequisite:

- The Buttonhole foot with slide No. 3A is attached.



- > Touch the icon «Buttonholes».
- > Select the buttonhole No. 51 – 59, No. 63 – 65 or No. 67 – 70.
- > Sew the desired buttonhole length.

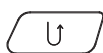

- > Push the button «Quick reverse» to program the length.



- > Push the button «Start/Stop» or the foot control.
 - The machine finishes the buttonhole automatically. All subsequent buttonholes are sewn at the same length.

9.11 Programming the Heirloom buttonhole

Prerequisite:

- The Buttonhole foot with slide No. 3A is attached.



- > Touch the icon «Buttonholes».
- > Select the Buttonhole No. 63.
- > Sew the desired buttonhole length.

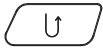

- > Push the button «Quick reverse» to program the length.
 - The machine finishes the buttonhole automatically. All subsequent buttonholes are sewn at the same length.

9.12 Sewing the manual 7-step buttonhole with the Buttonhole foot No. 3C (optional accessory)

The length of the buttonhole is determined manually when sewing. Bartack, eye and securing stitches are preprogrammed. The individual steps can also be selected by scrolling using the arrow icons or by touching the button «Quick Reverse».

Prerequisite:

- The Buttonhole foot No. 3C (optional accessory) is attached.



- > Touch the icon «Buttonholes».
- > Select the Buttonhole No. 51.



- > Touch the icon «i»-Dialog.



- > Touch the icon «Adjust the length manually».
 - Step 1 the display is activated for the buttonhole start.
- > Sew the desired buttonhole length.
 - Step 2 is activated.



- > Stop the machine at the desired length of the bead or at the end of the length marking.
- > Touch the icon «Scroll down» so that step 3 appears.
 - The machine sews straight stitches in reverse.
- > Stop at the height of the first stitch at the start of the buttonhole.
- > Touch the icon «Scroll down» so that step 4 appears.
 - The machine sews the upper bartack and stops automatically.
- > Touch the icon «Scroll down» so that step 5 appears.
 - The machine sews the second bead.
- > Stop the machine at the height of the first bead.

- > Touch the icon «Scroll down» so that step 6 appears.
 - The machine sews the bottom bartack and stops automatically.
- > Touch the icon «Scroll down» so that step 7 appears.
 - The machine secures and stops automatically.

9.13 Sewing the manual 5-step buttonhole with the Buttonhole foot No. 3C (optional accessory)

The length of the buttonhole is determined manually when sewing. Bartack, eye and securing stitches are preprogrammed. The individual steps can also be selected by scrolling using the arrow icons or by touching the button «Quick Reverse».

Prerequisite:

- The Buttonhole foot No. 3C (optional accessory) is attached.



- > Touch the icon «Buttonholes».
- > Select the Buttonhole No. 54.



- > Touch the icon «i»-Dialog.



- > Touch the icon «Adjust the length manually».
 - Step 1 the display is activated for the buttonhole start.
- > Sew the desired buttonhole length.
 - Step 2 is activated.



- > Stop sewing at the desired length of the bead or at the marking.
- > Touch the icon «Scroll down» so that step 3 appears.
- > The machine sews the eye or the keyhole and stops automatically.
- > Touch the icon «Scroll down» so that step 4 appears.
 - The machine sews the second bead in reverse.
- > Stop the machine at the first stitch where the buttonhole starts.
- > Touch the icon «Scroll down» so that step 5 appears.
 - The machine sews the upper bartack and secures automatically.

9.14 Cutting the buttonhole open with the seam ripper

- > Place a pin in each end of the buttonhole to avoid accidental cutting into ends of buttonhole.
- > Cut the buttonhole from both ends to the middle.

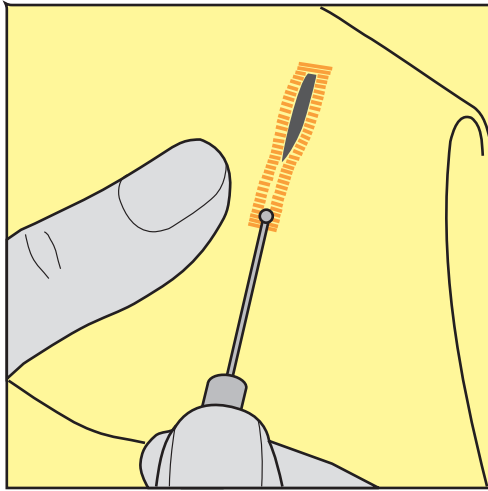

9.15 Cutting open buttonholes with the buttonhole cutter (optional accessory)

- > Place the fabric on an appropriate piece of wood.

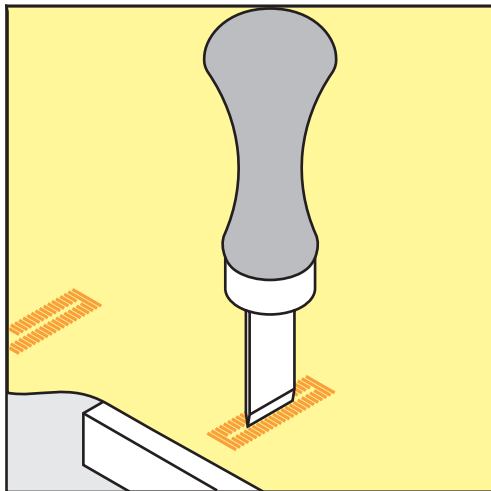

- > Position the cutter in the center of the buttonhole.
- > Press down on the cutter with your hand.

9.16 Sewing on buttons

The button sew-on program can be used to sew on buttons with two or four holes, press studs or snap fasteners.

Recommended sewing program:

Button sewing-on program No. 60

Recommended presser foot :

Button-sew-on foot No. 18 (optional accessory)

Alternative presser feet:

- Reverse pattern foot No. 1 or 1C
- Darning foot No. 9 (optional accessory)
- Reverse pattern foot No. 34 or 34C (optional accessory)

Adjusting the thread shank

For buttons on thicker fabrics, increase the thread shank = the distance between the button and the fabric. Buttons sewn on thin fabrics or buttons for decorative purposes only are stitched without a «thread shank».

NOTICE! The adjustment of the thread shank is only possible when using the Button sew-on foot No. 18.

- > Loosen the screw on the back of the presser foot.
- > Push the bar upwards according to the thickness of the fabric.
- > Tighten the screw.

Sewing on buttons

Prerequisite:

- The shank length is adjusted according the fabric thickness.
- The Button sew-on foot No. 18 or an alternative presser foot is attached.
- The attached presser foot has been selected in the user interface.
- The feed dog is lowered.



- > Touch the icon «Buttonholes».
- > Select the Button sew-on Program No. 60.
- > Turn the handwheel until the bobbin thread comes up.
- > **NOTICE! The Button sew-on program always starts above the left hole of the button.**
Position the button on the fabric. Place the button and the fabric beneath the needle so that the needle stitches into the left hole.
For buttons with 4 holes, sew the first front pair of holes first.
- > Lower the presser foot.
- > Perform the first stitches in the left hole via the handwheel.
- > Keep turning the handwheel until the needle changes to the right hole. In doing so, check whether the needle goes into the right hole. If necessary, adjust the stitch width by turning the upper Multifunction knob.
- > Hold the threads and push the foot control.
 - The machine sews on the button and stops automatically.
- > For increased stability, sew the Button sew-on program again.
- > Cut the threads with the machine. Alternatively, pull the sewing projects from under the sewing machine and trim the threads by hand. Pull the upper thread to the wrong side of the fabric and knot it with the bobbin thread.

9.17 Sewing eyelets



For increased stability sew the eyelet twice.

Prerequisite:

- The Reverse pattern foot No. 1C or the Open embroidery foot No. 20C is attached.









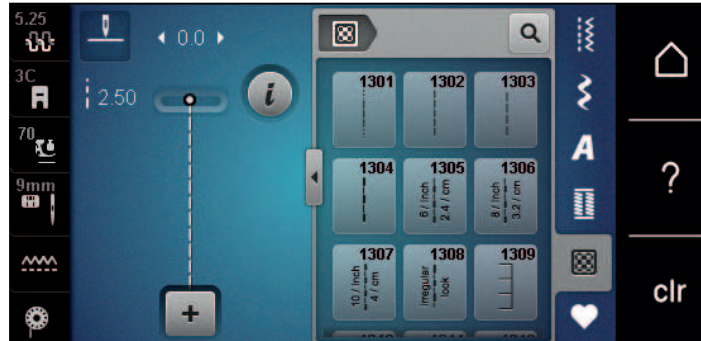



- > Touch the icon «Buttonholes».
- > Select the Eyelet Program No. 61 or No. 62.
- > Turn the «Upper Multifunctional knob» or the «Lower Multifunctional knob» to alter the size of the eyelet.
- > Sew the Eyelet Program.
 - The machine stops automatically at the end of the Eyelet Program.
- > Use an awl, punch pliers or a hole punch to open the eyelet.

10 Quilting

10.1 Overview Quilt Stitches



Stitch pattern	Stitch number	Name	Description
	1301	Quilting, securing program	To secure at the sewing start and sewing end with short stitches forward.
	1302	Quilting straight stitch	Straight stitch at 3 mm stitch length.
	1303	Piecing stitch/Straight stitch	Straight stitch at 2 mm stitch length.
	1304 – 1308	Hand-look quilt stitches	Imitation of handlook quilt stitch with monofilament.
	1309 – 1314	Blanket stitch	For appliqué and sewing on ribbons.
	1317 – 1327 1329 – 1330 1339 – 1346 1363 – 1371 1373 – 1378	Decorative quilting stitches	For "Crazy Patchwork" and quilting.
	1315	Satin stitch	For appliqué.
	1316	Blindstitch narrow	To sew blind stitches.
	1331	Stippling stitch	Imitation of stipple quilting.
	1332	Feather stitch	For "Crazy Patchwork" and embellishing.

Stitch pattern	Stitch number	Name	Description
	1333 – 1338	Feather stitch variations	For "Crazy Patchwork" and embellishing.

10.2 Quilting, Securing Program

Prerequisite:

- The Reverse pattern foot No. 1C is attached.



- > Touch the icon «Quilt stitches».
- > Select Quilt stitch pattern No. 1301.
- > Press the foot control.
 - The machine sews 6 stitches forward automatically when sewing is started.
- > Sew the seam in the desired length.

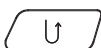

- > Push the button «Quick reverse».
 - The machine sews 6 stitches forward automatically and stops automatically at the end of the Securing Program.

10.3 Sewing handlook quilt stitches

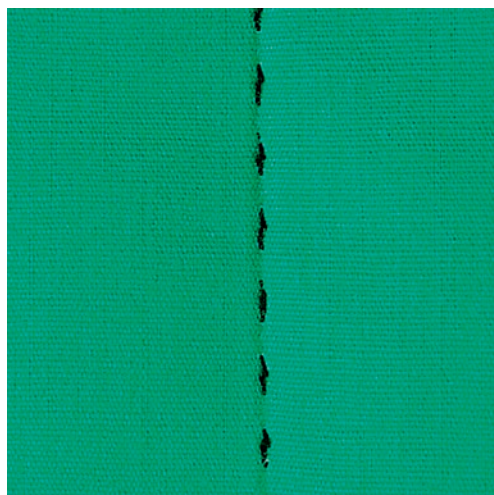

Handlook quilt stitches are suitable for all fabrics and sewing projects which should look hand sewn. It is recommended to use a monofilament thread as upper thread and an embroidery thread as bobbin thread. The sewing speed should be moderate to prevent the monofilament from breaking. If required, the upper thread tension and the balance can be adjusted to the sewing project and the desired quilt stitch.

Prerequisite:

- The Reverse pattern foot No. 1C is attached.



- > Touch the icon «Quilt stitches».
- > Select Handlook quilt stitches No. 1304 – 1308.
- > If required, adjust the upper thread tension and the balance to the sewing project and the desired quilt stitch.
- > Press the foot control or the button «Start/Stop» to start the machine.

10.4 Guiding the quilt work freely



Quilt gloves with rubber fingertips (optional accessory) will help when guiding the fabric.

It is recommended to use the slide-on table and the Free Hand System. With free-motion quilting, it is of advantage to quilt from the center outwards and to guide the fabric using smooth, round movements to form the design of your choice. Free-motion quilting and darning are based on the same free-motion principles.

With stipple quilting, entire surfaces of the fabric are filled with quilt stitches. The single lines of stitching are rounded and never cross one another.

Prerequisite:

- The top layer, the batting and the backing are pinned together or basted.
- The feed dog is lowered.
- The Darning foot No. 9 (optional accessory) is attached.



- > Touch the icon «Practical stitches».
- > Select the Straight stitch No. 1.
- > Adjust the upper thread tension and the balance to the sewing project if necessary.
- > Press the foot control or the button «Start/Stop» to start the machine.
- > Hold both hands close to the presser foot like an embroidery hoop to guide the fabric.
- > If the thread is lying on top of the fabric, slow down the movement.
- > If there are knots on the wrong side of the fabric, move the fabric more quickly.

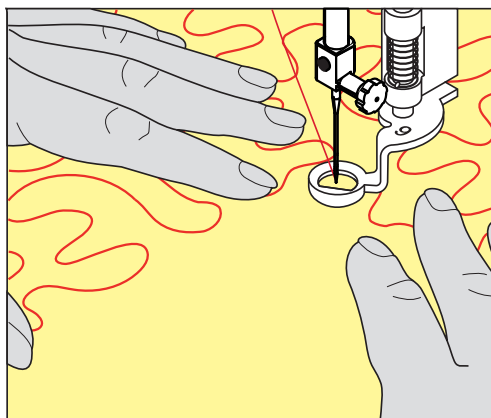

11 BERNINA Stitch Regulator (BSR)

The BERNINA Stitch regulator equalizes the stitch length which results of the free movement of the fabric while free-motion sewing - a sewing technique which grows more and more popular. When free-motion sewing with the BSR presser foot, every stitch is equally long and the stitch formation is perfectly regular.

As soon as the BSR presser foot is attached and the feed dog is lowered, the selection menu of the desired mode appears in the display of the machine. The BSR presser foot can be used with sewing straight stitch as well as zig zag.

The BSR presser foot reacts on the movement of the fabric and therefore controls the speed of the machine up to the highest possible speed. It can be said: The faster the movement of the material, the higher the speed of the machine.

If the fabric is moved too quickly, an acoustic signal sounds. The beeper can be activated or deactivated in the «BSR» display. The sound of the beeper can also be activated or deactivated in the Setup Program.

11.1 BSR mode 1

The BSR function can be controlled via the foot control or with the button «Start/Stop». Start the BSR mode. At the BSR presser foot a red light is on. By moving the fabric the machine accelerates. If the fabric isn't moved, securing in place is possible without pressing an additional button. When working via the foot control or when using the button «Start/Stop», the BSR mode doesn't stop automatically.

11.2 BSR mode 2

The BSR function can be controlled via the foot control or the button «Start/Stop». The machine starts only when the foot control or the button «Start/Stop» is pressed and the fabric is moved simultaneously. Without moving the fabric, the BSR2 modus stops after about 7 seconds. The red light goes off (only when working with the button «Start/Stop»). When working via the foot control, the red light doesn't go off.

11.3 BSR function with Straight stitch No. 1

This function allows free-motion quilting with straight stitch and a pre-programmed stitch length up to 4 mm. The programmed stitch length is maintained within a certain speed, independent of the fabric movement.

11.4 BSR function with Zig zag No. 2

The zig zag can be used e.g. for thread painting. The set stitch length will **not** be maintained when sewing the zig zag stitch, but the BSR function simplifies the application.

11.5 Sewing preparations for quilting

Attach the BSR presser foot

Prerequisite:

- The machine is switched off.
 - The needle is raised.
 - The presser foot is raised.
- > Remove the fitted presser foot.
- > Attach the BSR presser foot.

- > Insert the plug for the cable vertically into the BSR connection (1) until you feel it click into place.



- > Switch the machine on.
 - The BSR display opens and the BSR 1 mode is activated.

Changing the presser foot sole

NOTICE

The lens of the BSR presser foot is dirty

The machine doesn't recognize the BSR presser foot.

- > Clean the lens with a soft, slightly damp cloth.

The standard stitch length is 2 mm. When sewing small shapes and stippling it is recommended to shorten the stitch length to 1 – 1.5 mm.

- > Raise the needle.
- > Raise the BSR foot.
- > Switch the machine off and disconnect it from the power supply system.
- > Remove the BSR foot from the machine.
- > Press both push buttons at the BSR foot against each other.

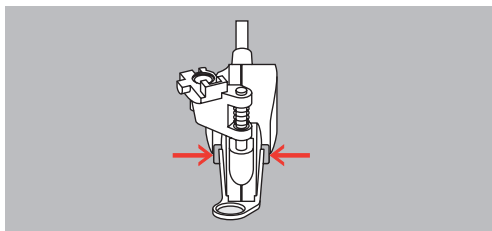

- > Pull the presser foot sole out of the guide downwards.
- > Insert the new presser foot sole into the guide and push upwards until it clicks into place.
- > Attach the BSR presser foot.

11.6 Using the BSR mode

The BSR function can be controlled via the foot control or the button «Start/Stop».

Starting via the foot control: The foot control needs to be pressed while quilting. The machine keeps running in the BSR1 mode until the foot control is released, even if the fabric isn't moved.

If quilting is stopped in the BSR2 mode, the machine sews another stitch depending on the needle position and stops with needle position up.

Prerequisite:

- The slide-on table is attached.
- The knee lifter of the Free Hand System is attached.

> Lower the feed dog.

> Select the desired BSR mode.



> Push the button «Start/Stop» or press the foot control to lower the presser foot.

> Push the button «Start/Stop» again or press the foot control again and keep pressed to start the BSR mode.

- At the BSR presser foot a red light is on.

> Move the fabric to control the speed of the machine in the BSR mode.



> Push the button «Start/Stop» again or release the foot control to stop the BSR mode.

- The BSR mode stops and the red light at the presser foot goes off.

> Touch the icon «BSR» (1) to deactivate the BSR mode and to quilt without automatic stitch length.

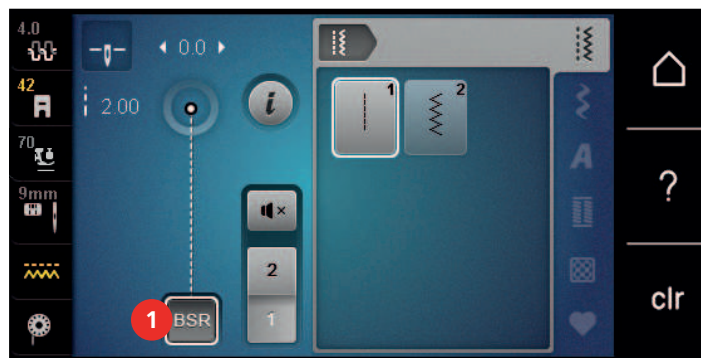

11.7 Securing

Securing in BSR1 mode with the button «Start/Stop»

Prerequisite:

- The BSR presser foot is attached and connected with the machine.
- The BSR display is opened and the BSR1 mode is activated.

> Lower the feed dog.

> Lower the presser foot.



> Push the button «Needle up/down» twice.

- The bobbin thread is brought up.

> Hold the upper and the bobbin thread.



> Push the button «Start/Stop».

- Start the BSR mode.

> Sew 5 – 6 securing stitches.



> Push the button «Start/Stop».

- The BSR mode stops.

> Cut the thread.

Securing in BSR2 mode

Prerequisite:

- The BSR presser foot is attached and connected with the machine.
- The BSR display is open and the BSR2 mode is activated.

- > Lower the presser foot.
- > Touch the icon «i»-Dialog.



- > Touch the icon «Securing».



- > Press the foot control or the button «Start/Stop».



By moving the fabric some short securing stitches are sewn, then the programmed stitch length is activated and the securing function is deactivated automatically.

12 My BERNINA Embroidery

12.1 Overview Embroidery module



- | | | | |
|---|--------------------------------|---|-----------------------------|
| 1 | Release lever/carrying handle | 4 | Guide rails for the machine |
| 2 | Embroidery arm | 5 | Connection to the machine |
| 3 | Coupling for securing the hoop | | |

12.2 Supplied accessories Embroidery module

Overview accessory Embroidery module







Illustration	Name	Purpose
	Embroidery foot #26	For embroidering, darning and free-motion quilting.
	Large oval embroidery hoop	To embroider large embroidery motifs or motif combinations up to 145 x 255 mm (5.70 x 10.04 in). Including the template for precise fabric positioning.

Illustration	Name	Purpose
	Medium embroidery hoop	To embroider medium-sized embroidery motifs up to 100 x 130 mm (3.94 x 5.12 in). Including the template for precise fabric positioning.
	USB Connecting cable	To transfer data from the computer to the machine or vice versa.
	Embroidery needle assortment	For embroidering.
	Template holder	To place and remove the template in or out of the embroidery hoop.
	Net for upper thread spool	To support an even unwinding of the thread with slippery embroidery threads.

12.3 Overview User Interface

Overview functions/visual information

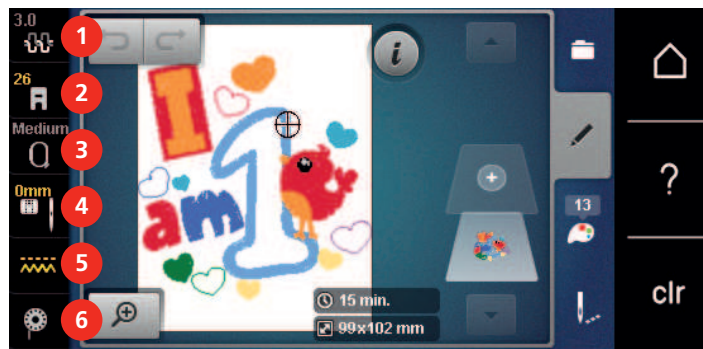

- | | | | |
|---|--|---|-------------------------------------|
| 1 | Upper thread tension | 4 | Stitch plate/Needle selection |
| 2 | Presser foot display/Presser foot selection | 5 | Feed dog up/down |
| 3 | Embroidery hoop selection /Embroidery hoop display | 6 | Fill level of bobbin thread display |

Overview System settings

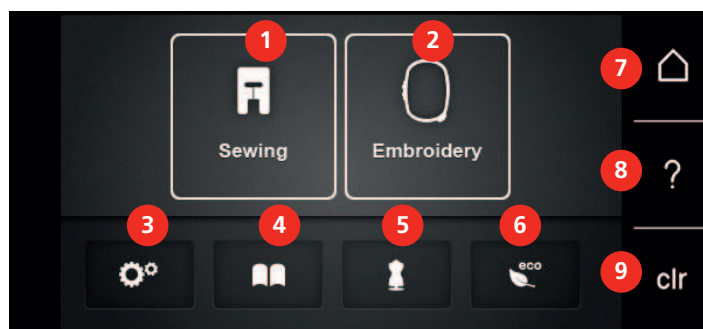

- | | | | |
|---|-----------------------|---|-------------------------|
| 1 | Sewing mode | 6 | eco |
| 2 | Embroidery mode | 7 | Home |
| 3 | Setup Program | 8 | Help |
| 4 | Tutorial | 9 | Back to default setting |
| 5 | Embroidery Consultant | | |

Overview Selection menu embroidery



- | | | | |
|---|-----------------------------|---|-------------------|
| 1 | Selection embroidery motifs | 3 | Color information |
| 2 | Editing embroidery motifs | 4 | Embroidery |

12.4 Important Embroidery information

Upper thread

A good quality thread (brand manufacturer) is essential for embroidery so that the embroidery is not affected negatively because of poor thread or thread breakage.

Embroidery is particularly effective if you use 40wt glossy rayon or polyester embroidery threads as upper threads. They are available in a wide range of colors for beautiful embroidery.

- Glossy polyester with a brilliant sheen is a hard wearing, colorfast thread and has a high tensile strength which is suitable for all types of embroidery.
- Rayon is a soft viscose fiber with a brilliant sheen and suitable for fine, delicate embroidery, or items that will not receive excessive wear and tear.
- Metallic thread is a light to medium-weight thread suitable for special effects in embroidery.
- When working with metallic threads, the automatic bobbin thread cutter should be deactivated. The other thread cutters shouldn't be used either because the knives are likely to wear off very quickly.

13 Embroidering preparation

13.1 Attaching the Module

Prerequisite:

- Extension table must not be fitted.
- > Make sure that the module and the machine are placed on a stable, even surface.
- > Ensure that the embroidery arm can move freely.
- > Carefully slide the embroidery module from left to right into the machine's embroidery module connection (1) and the guide rail (2).



13.2 Removing the embroidery module

- > Push the release lever (1) at the carrying handle of the embroidery module, keep it pressed and at the same time, move the embroidery module carefully to the left.



13.3 Preparing the machine

lower the feed-dog

- > Touch the «Feed dog up/down» button to lower the feed dog.



- > Fit the straight and CutWork stitch plate.
- > Fit the needle.
- > Fit the embroidery foot.

Selecting an embroidery motif

All of the embroidery motifs can be either directly embroidered or can be changed using different functions offered by the embroidering machine. Please find all the embroidery motifs at the end of this instruction manual. In addition to that, embroidery motifs can be loaded from the personal memory or from the BERNINA USB stick (optional accessory).



- > Touch the icon «Home».



- > Touch the icon «Embroidery mode».
- > Select the folder for alphabet, embroidery motifs or your own embroidery motifs.

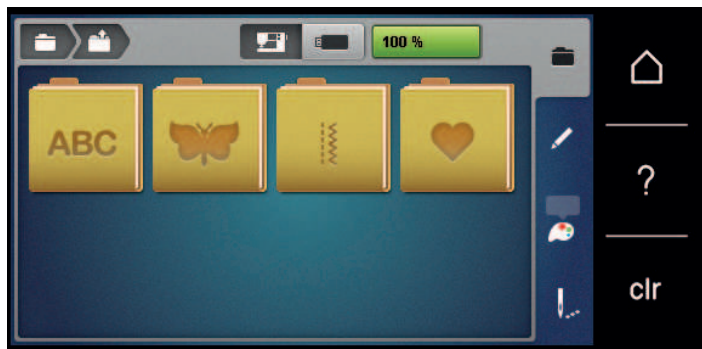

- > To open an embroidery motif category, select a folder.
- > To select an embroidery motif, either scroll through the view and select the required embroidery motif, or touch the icon «Select by number», enter the number for the embroidery motif and select the embroidery motif with the white frame.



13.4 Embroidery foot

Attaching the embroidery foot

- > Raise the needle.
- > Raise the presser foot.
- > Switch the machine off and disconnect it from the power supply system.
- > Push the clamping lever up (1).
- > Remove the presser foot (2).



- > Insert the embroidery foot from below into the bracket.
- > Press the clamping lever down.



Selecting the presser foot in the User Interface

After having attached the respective embroidery foot (Embroidery foot No. 26, supplied accessory with the embroidery module), you can select and save it on the machine. Moreover, alternative feet are displayed which will also be suitable for the selected embroidery motif.

- > Switch the machine on.
- > Select the embroidery motif.
- > Touch the icon «Presser foot display/Presser foot selection».



- > Select the attached embroidery foot.



13.5 Needle and stitch plate

Inserting the embroidery needle



Embroidery needles of the type 130/705 H-SUK provide a larger eye and are slightly rounded. This avoids thread abrasion when using Rayon- and cotton embroidery thread. Depending on the embroidery thread use a size No. 70-SUK to No. 90-SUK needle.

- > Raise the needle.
- > Switch off the machine and disconnect it from the power supply.
- > Remove the fitted foot.
- > Loosen the fixing screw for the needle by hand.



- > Pull the needle downwards.
- > Hold the new needle with the flat side to the rear.
- > Slide the needle upwards as far as it will go.
- > Tighten the fixing screw by hand.

Selecting the embroidery needle in the User Interface

After having changed the needle, it can be checked whether or not it is suitable to be used together with the selected stitch plate.



- > Touch the icon «Needle/Stitch plate selection».

- > Select the attached needle.



- If the selected needle is suitable in combination with the stitch plate, sewing can be started.
- If the selected needle is not suitable in combination with the stitch plate, starting the machine is automatically prevented.

Selecting the needle type and the needle size

Convenient memory function: To prevent a loss of information, the needle type and the needle size can be saved additionally on the machine. The saved needle type and the saved needle size can be checked at any time.



- > Touch the icon «Stitch plate/Needle selection».



- > Touch the icon «Needle type/Needle size».
- > Select the needle type (1) of the inserted needle.
- > Select the needle size (2) of the inserted needle.

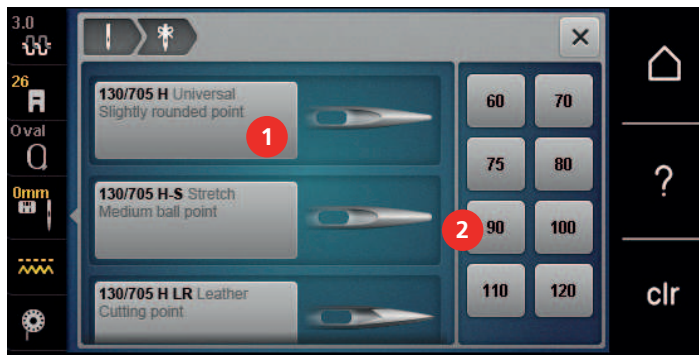

Adjusting the needle position up/down



- > To pull the thread upwards, touch the icon «Needle up/down».
 - The needle is lowered and raised once.

Attaching the stitch plate

There is a small hole in the area of the needle on the CutWork/straight stitch plate (optional accessory). The thread draw-in (thread knotting of upper thread and bobbin thread) is therefore optimized. This results in a nicer stitch formation.

- > Touch the icon «Feed dog up/down» to lower the feed dog.



- > Switch off the machine and disconnect it from the power supply.
- > Remove the needle.
- > Remove the presser foot.
- > At the marking on the rear of the stitch plate, push the stitch plate downwards until it tips.



- > Remove the stitch plate.
- > Position the openings on the CutWork/straight stitch plate (optional accessory) above the corresponding guide pins and push them downwards until they click into place.

Selecting the stitch plate in the User Interface

After having replaced the stitch plate, it can be checked whether it can be used together with the selected needle.



- > Touch the icon «Stitch plates/Needle selection».
- > Select the stitch plate CutWork/Straight (optional accessory).



Thread-up command

The machine must be ready for embroidery to bring up the bobbin thread. The bobbin thread can be brought up in one step for a manual knotting. If no securing stitches are wanted, it is recommended to deactivate the securing stitches in the Setup.



- > Hold the upper thread.
- > Press the button «Needle up/down».
 - The bobbin thread is brought up automatically.

13.6 Embroidery hoop

Overview Embroidery hoop selection

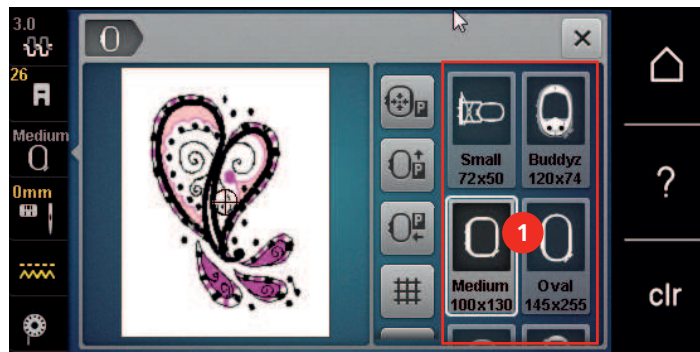

1 Hoop selection

Selecting the embroidery hoop

The best embroidery result is achieved when the smallest possible embroidery hoop for the embroidery motif is selected.

The embroidery motif has a pre-set size which is displayed.

Prerequisite:

- The embroidery motif is selected.



- > Touch the icon «Hoop selection».
 - The machine selects the optimal embroidery hoop according to the size of the embroidery motif automatically. If the pre-set embroidery hoop would not be available, another desired embroidery hoop can be selected. When an embroidery hoop is attached which does not correspond with the selected one, the attached hoop is considered active and the embroidery motif area is displayed accordingly.
- > Select the desired embroidery hoop.

Tear-away stabilizers

Using a stabilizer ensures more stability of the embroidery project. A tear-away stabilizer suits all woven and non-stretch materials. 1 – 2 layers can be used. Stabilizers are available in different weights. With larger embroidered areas the stabilizer will remain under the embroidery thread. The stabilizer is applied to the wrong side of the fabric with temporary adhesive spray. Carefully tear away excess stabilizer after embroidering.

Cut-away stabilizers

Using a stabilizer ensure more stability of the embroidery project. A cut-away stabilizer suits all elastic materials. 1 – 2 layers can be used. Stabilizers are available in different weights. With larger areas to be embroidered the stabilizer will remain under the embroidery thread. The stabilizer is applied to the wrong side of the fabric with temporary adhesive spray. Carefully cut away excess stabilizer after embroidering.

Using adhesive spray

The application of spray adhesive is recommended for stretch and smooth materials and knitware. It prevents the fabric from losing shape and slipping. Appliqués can be exactly positioned with spray adhesive. The spray adhesive shouldn't be used near the machine to avoid contamination.

- > Use the adhesive spray carefully at a distance 25 – 30 cm (9 – 12 inch) when spraying the stabilizer.
- > Adhere the sprayed stabilizer to the wrong side of the fabric carefully, smoothing material so there are no puckers.
- > Position smaller parts such as pocket flaps or collars on the stabilizer.
- > To avoid the possibility of getting hoop marks when working with napped materials or fleece, don't hoop the parts but spray the stabilizer and hoop it.
- > Adhere the fabric to be embroidered.
- > Remove any adhesive residue before starting the machine.

Using spray starch

Spray starch is ideal for additional stiffening fine, loosely woven materials. Always use an additional stabilizer on the wrong side of the material.

- > Spray the area to be embroidered.
- > Let it dry or press gently with a warm iron if necessary.

Using iron-on interfacing

Iron-on interfacings are available in a variety of weights. It is recommended to use an iron-on interfacing which is easily removable from the basic fabric. An Iron-on interfacing suits all materials that are easily distorted like stretch fabric such as tricot and jersey.

- > Iron-on interfacings are ironed to the wrong side of the material using a warm iron.

Using paper-backed adhesive stabilizer

Paper-backed adhesive stabilizers are intended to be used for fabrics such as jersey and silk as well as for embroidery projects which are not suited to be hooped in the embroidery hoop.

- > Place the stabilizer in the hoop, so that the paper side is up.
- > Use a pair of scissors to score the paper and remove paper in the hoop area.
- > Position the fabric to be embroidered on the stabilizer and press it on place.
- > Remove any adhesive residue before starting the machine.

Using water-soluble stabilizer



For lace embroidery it is recommended to hoop 1 – 3 layers of water-soluble stabilizer in the embroidery hoop. As the embroidery motif is not embroidered on the fabric, only the thread embroidered motif is left. The embroidery motifs should be combined with short stitches otherwise the individual motifs may fall out.

Water-soluble stabilizers are ideal for fine, sheer fabrics where other stabilizers may show through the embroidery stitches as well as for lace embroidery. The stabilizer dissolves in water. Water-soluble stabilizers are an ideal protection for looped pile fabrics preventing the loops from being damaged. It prevents threads from sinking into the material and keeps the fabric pile from poking through the embroidery.

- > Place the stabilizer on the underside of the material.
- > Use adhesive spray to adhere stabilizer if necessary.
- > For material with a pile, reinforce with additional, suitable stabilizer on the wrong side.
- > Place all the layers together into the embroidery hoop.
- > After dissolving, lay the motif down flat and let dry.

Preparing the embroidery hoop

The embroidery hoop consists of an outer and an inner hoop. There is a corresponding template for every hoop. The area to be embroidered is marked in 1 cm (0.39 inch) squares. The center and corner points are marked with holes. The required marks can be transferred to the material.

- > Mark the center of an embroidery motif on the fabric, using a water-soluble pen.

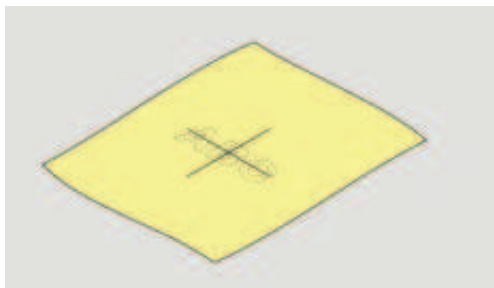

- > Loosen the screw on the outer hoop.
- > Remove the inner hoop.
- > Make sure that the arrows marks of both hoops match.
- > Attach the template holder.
- > Place the template in the inner hoop, so the BERNINA logo is at the front edge at the arrow mark until it clicks into place.

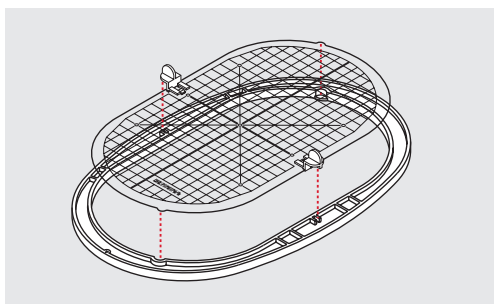

- > Place the material under the inner hoop.
- > Line up the marked center point on the center of the template.
- > Place the material and the inner hoop on the outer hoop so that the arrows of both hoops match.

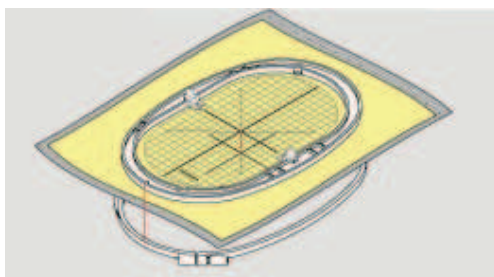

- > Fit the hoops into each other; ensure that the material does not move.
- > Hoop the fabric to be embroidered tightly.
- > Tighten the screw.
- > Remove the template from the hoop by using the template holder.
- > To avoid scratches on the free arm, press the inner hoop into the outer hoop so that the inner hoop including the fabric protrudes downwards by up to 1 mm.

Attaching the hoop

- > Raise the needle.
- > Raise the embroidery foot.
- > Hold the hoop with the right side of the fabric up with the attaching mechanism to the left.

- > Position the hoop below the embroidery foot.
- > Press both attaching mechanisms (1) of the hoop towards each other.
- > Position the embroidery hoop (2) above the bracket of the embroidery arm.
- > Press the hoop down until it clicks in position.
- > Release the attaching mechanism (1).

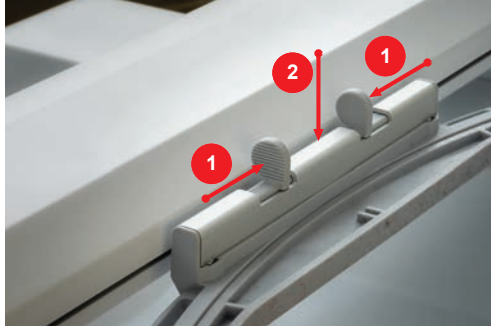

- > Press the attaching mechanisms of the hoop towards each other to remove the hoop.
- > Remove the hoop.

Overview Embroidery functions

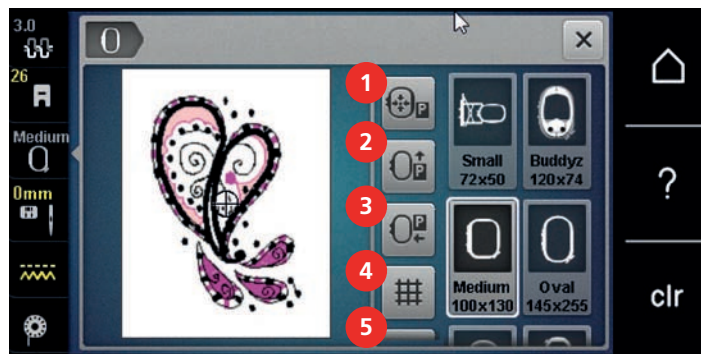

- | | | | |
|---|---|---|--|
| 1 | Centering the embroidery hoop to the needle | 4 | Grid on/off |
| 2 | Moving the hoop to the back | 5 | Motif center |
| 3 | Moving the module for the sewing mode | 6 | Virtual Positioning (is visible while scrolling) |

Center the needle to the embroidery hoop

Relocating the embroidery hoop facilitates threading when the needle is close to the embroidery hoop.



- > Touch the icon «Embroidery hoop display/Embroidery hoop selection».



- > Touch the icon «Center the needle to the embroidery hoop».
- > Threading the upper thread.



- > Push the button «Start/Stop» to move the embroidery hoop back to the last position.

Moving the hoop to the back

To facilitate changing the bobbin, it is recommended to move the hoop to the back before threading. This makes it easier to open the bobbin cover.



- > Touch the icon «Embroidery hoop display/Embroidery hoop selection».

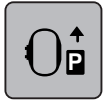

- > Touch the icon «Move the hoop to the back».
- > Thread the bobbin thread (see page 45).



- > Push the button «Start/Stop» to move the embroidery hoop back to the last position. If necessary, pull the upper thread back.

Moving the module for the sewing mode

The embroidery module can be positioned so that any sewing projects can be carried out even if the module is connected.



- > Touch the icon «Embroidery hoop display/Embroidery hoop selection».
- > Remove the hoop.



- > Touch the icon «Move the module for the sewing mode».



- > Touch the icon «Home».



- > Touch the icon «Sewing mode».

Grid on/off

When the center of the hoop and the grid are displayed, the embroidery motif can be positioned more exactly.



- > Touch the icon «Embroidery hoop display/Embroidery hoop selection».

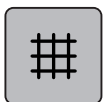

- > Touch the icon «Grid on/off» to display the center of the hoop on the display.
- > Touch the icon «Grid on/off» again to display the grid.
- > Touch the icon «Grid on/off» again so that the center of the hoop and the grid disappear.

Locating the center of the embroidery motif

The embroidery hoop is positioned so that the needle is exactly above the center of the embroidery motif or the motif begin.



- > Touch the icon «Embroidery hoop display/Embroidery hoop selection».

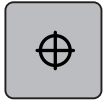

- > Touch the icon «Center of the embroidery motif» to position the hoop so that the needle is placed exactly over the center of the embroidery motif.
- > Touch the icon «Center of the embroidery motif» again to position the hoop so that the needle is placed exactly over the motif start.

Virtual positioning of the embroidery hoop

The embroidery hoop is automatically moved to the new position as soon as the embroidery motif is repositioned. Therefore, the icon «Virtual positioning» is activated automatically and outlined in yellow when an embroidery hoop is attached.

Prerequisite:

- The hoop is attached.



- > Touch the icon «Embroidery hoop display/Embroidery hoop selection».



- > Touch the icon «Virtual positioning» to deactivate the automatic movement of the hoop when having repositioned the embroidery motif.
 - The icon «Virtual positioning» is not outlined in yellow.
- > Touch the icon «Virtual positioning» again to activate the automatic movement of the hoop when having repositioned the embroidery motif.

14 Setup Program

14.1 Adjusting the embroidery settings in the Setup Program

Further information about this topic (see page 53).

15 Creative embroidering

15.1 Overview embroidering



- | | | | |
|---|---|---|-------------------------|
| 1 | Embroidery time/Embroidery motif size in mm or inch | 5 | Area to be embroidered |
| 2 | Scaling up, downsizing and moving the embroidery motif view | 6 | «i»-Dialog |
| 3 | Undoing entries | 7 | Embroidery motif layers |
| 4 | Redoing entries | | |

15.2 Selecting and changing the embroidery motif



- > Touch the icon «Selection».



- > Touch the icon «Upload embroidery motif».
- > Select a new embroidery motif.

15.3 Checking the embroidery time and the embroidery motif size

In the display «Edit» at lower right (1), the estimated embroidery time is indicated in minutes and the width and height of the embroidery motif is indicated in millimeters.

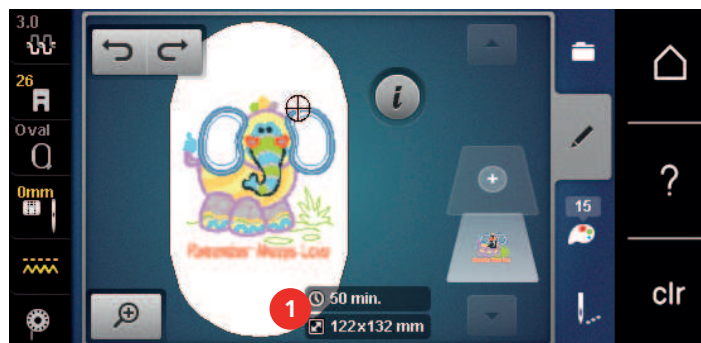

15.4 Regulating the speed

The sewing speed can be adjusted infinitely variable with the slide.

- > Move the slide to the left to reduce the sewing speed.
- > Move the slide to the right to increase the sewing speed.

15.5 Editing the embroidery motif

Overview Editing embroidery motif

- > To edit an embroidery motif, select the embroidery motif.
- > Touch the icon **i**-Dialog.



- | | | | |
|---|-------------------------|----|---|
| 1 | Zoom out | 10 | Mirror image up/down |
| 2 | Zoom in | 11 | Duplicating |
| 3 | Moving the view | 12 | Endless Embroidery |
| 4 | Moving the motif | 13 | Deleting |
| 5 | Moving the motif | 14 | Checking the motif size |
| 6 | Rotating the motif | 15 | Curve text (only with the selected alphabet, can be viewed by scrolling) |
| 7 | Changing the size | 16 | Group the embroidery motifs (can be viewed by scrolling) |
| 8 | Pinpoint placement | 17 | Changing the sequence within an embroidery motif combination (appears by scrolling) |
| 9 | Mirror image left/right | 18 | Change the stitch type/stitch density (can be viewed by scrolling) |

Scaling up the embroidery motif view

The view of the embroidery motif can be scaled up. In addition to that, the view can be adjusted with or without changing the embroidery position.

- > Select an embroidery motif.
- > Touch the icon «Zoom in» to edit the view of the embroidery motif.



- > Touch the icon «Zoom in» 1 to 4 times to enlarge the view of the embroidery motif gradually.



- > Touch the icon «Zoom out» 1 to 4 times to get back to the Edit Mode.



Downsizing the embroidery motif view

The view of the embroidery motif can be downsized. In addition to that, the view can be adjusted with or without changing the embroidery position.

- > Select an embroidery motif.
- > Touch the icon «Zoom in» to edit the view of the embroidery motif.



- > Touch the icon «Zoom out» 1 to 4 times to downsize the view of the embroidery motif gradually.



Moving the embroidery motif view

The view of the embroidery motif can be moved. In addition to that, the view can be adjusted with or without changing the embroidery position.

- > Select an embroidery motif.
- > To activate the icon «Move the view», touch the icon «Zoom in».



- The icon «Move the view» is active (dark grey)
- > Move the view of the embroidery motif.
 - The embroidery position is not altered.



- > Touch the icon «Zoom out» to get back to the Edit Mode.



Moving the embroidery motif in enlarged view

The view of the embroidery motif can be moved. In addition to that, the view can be adjusted with or without changing the embroidery position.

- > Select an embroidery motif.
- > To display the icon «Move the embroidery motif», touch the icon «Zoom in».



- > Touch the icon «Move the stitch pattern».
 - The icon turns dark gray.
- > Move the view of the embroidery motif.
 - The embroidery position is altered.



- > Touch the icon «Zoom out» to get back to the Edit Mode.



Moving the embroidery motif

- > Select an embroidery motif.
- > Touch the icon «i»-Dialog.



- > Touch the icon «Move the stitch pattern».
- > Turn the «Upper Multifunction knob» to move the embroidery motif horizontally in 1/10-mm steps.
- > Turn the «Lower Multifunction knob» to move the embroidery motif vertically in 1/10-mm steps or
- > touch the embroidery motif, keep it pressed and move it as you like.
 - The relocation is indicated in the yellow-framed icons.

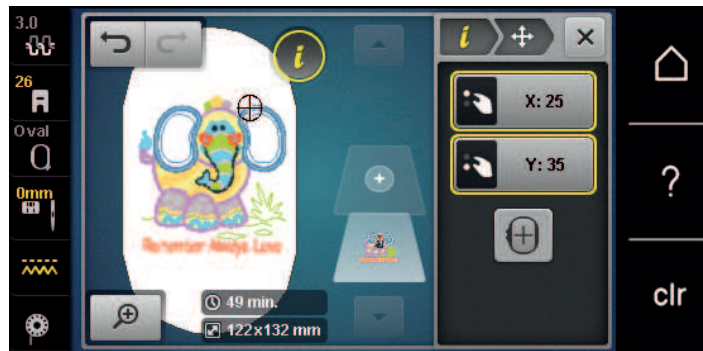
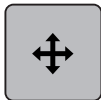

- > Touch the icon «Center of the embroidery motif».
 - The embroidery motif is repositioned in the center of the embroidery hoop.



Rotating motif



- > Select an embroidery motif.
- > Touch the icon «i»-Dialog.

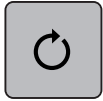

- > Touch the icon «Rotate the motif».
- > Turn the «Upper Multifunctional knob» or the «Lower Multifunctional knob» to the right to rotate the embroidery motif clockwise.
- > Turn the «Upper Multifunctional knob» or the «Lower Multifunctional knob» to the left to rotate the embroidery motif counter-clockwise.



- > Touch the icon «Rotate the motif +90°» to rotate the embroidery motif in 90°-steps.

Altering the embroidery motif size proportionally



Enlargements or reductions of the motif size up to maximum 20% achieve the best results.

If the motif size is to be altered by more than 20%, the motif should be adapted in a separate embroidery software and then reloaded onto the machine.



- > Select an embroidery motif.
- > Touch the icon «i»-Dialog.



- > Touch the icon «Alter the embroidery size».



- > To change the embroidery motif size proportionally, the icon «Retain proportions» must have a white frame.

Only touch the icon «Retain proportions» when the icon does not have a white frame.

- The icon «Retain proportions» has a white frame.



- > Turn the «Upper/Lower Multifunctional knob» to the right to scale up the embroidery motif proportionally.
- > Turn the «Upper/Lower Multifunctional knob» to the left to downsize the embroidery motif proportionally.

Altering the embroidery motif size disproportionately



Enlargements or reductions of the motif size up to maximum 20% achieve the best results.

If the motif size is to be altered by more than 20%, the motif should be adapted in a separate embroidery software and then reloaded onto the machine.

- > Select an embroidery motif.



- > Touch the icon «i»-Dialog.



- > Touch the icon «Alter the embroidery size».



- > To change the embroidery motif size disproportionately, the icon «Retain proportions» must not have a white frame.

Only touch the icon «Retain proportions» when the icon has a white frame.

- The icon «Retain proportions» does not have a white frame.

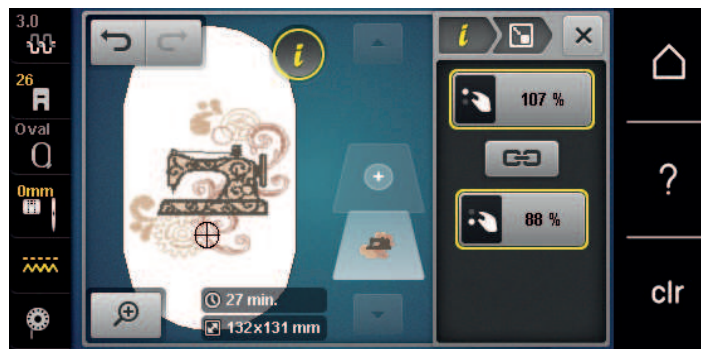

- > To make the embroidery motif wider, turn the «Upper multifunction knob» clockwise.
- > To make the embroidery motif narrower, turn the «Upper multifunction knob» anti-clockwise.
- > To make the embroidery motif longer, turn the «Lower multifunction knob» clockwise.
- > To make the embroidery motif shorter, turn the «Lower multifunction knob» anti-clockwise.

Mirroring embroidery motifs

Embroidery motifs can be mirror-imaged both vertically and horizontally.



- > Select an embroidery motif.
- > Touch the icon «i»-Dialog.



- > Touch the icon «Mirror image left/right» to mirror the embroidery motif vertically.



- > Touch the icon «Mirror image up/down» to mirror the embroidery motif horizontally.

Bending the text

Texts can be arranged and designed arc-shaped.



- > Create an alphabet embroidery motif.
- > Touch the icon «i»-Dialog.



- > Touch the icon «Bend text».
- > Turn the «Upper Multifunctional knob» to alter the distance between the characters in millimeter-steps.
- > Turn the «Lower Multifunctional knob» to the left or to the right to bend the lettering upwards or downwards.

Changing the stitch type

If the satin stitches are too long, they can be changed to step stitches.

- > Select an embroidery motif.
- > Touch the icon «i»-Dialog.



- > Touch the icon «Change the stitch type».



- > Touch the switch in the upper section of the display (1) to change the satin stitch to the step stitch.
- > Adjust the desired stitch length (2) with the icons «-» or «+».

Altering the stitch density

If the satin stitches are embroidered too densely, the stitch density can be adjusted.

- > Select an embroidery motif.
- > Touch the icon «i»-Dialog.



- > Touch the icon «Change the stitch type».
- > Adjust the desired stitch density (1) with the icons «-» or «+».



Checking the size and the position of the embroidery motif

It can be checked whether or not the embroidery motif matches the designated position/location on the fabric. Points which are beyond the embroidery hoop are not traveled to.

- > Select an embroidery motif.
- > Touch the icon «i»-Dialog.

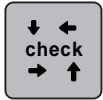

- > Touch the icon «Check embroidery motif size».
 - The embroidery hoop travels all the way until the needle is at the position as it is indicated in the display.
- > Touch the icon «Corner top left» to select the top left corner of the embroidery motif.
 - The embroidery hoop travels all the way until the needle is at the position as it is indicated in the display.
- > Touch the icon «Corner top right» to select the top right corner of the embroidery motif.
 - The embroidery hoop travels all the way until the needle is at the position as it is indicated in the display.
- > Touch the icon «Corner bottom left» to select the bottom left corner of the embroidery motif.
 - The embroidery hoop travels all the way until the needle is at the position as it is indicated in the display.
- > Touch the icon «Corner bottom right» to select the bottom right corner of the embroidery motif.
 - The embroidery hoop travels all the way until the needle is at the position as it is indicated in the display. If the embroidery motif hasn't been positioned correctly yet, the position can be altered via the «Upper/Lower Multifunction knobs» and the complete embroidery positions can be checked again.

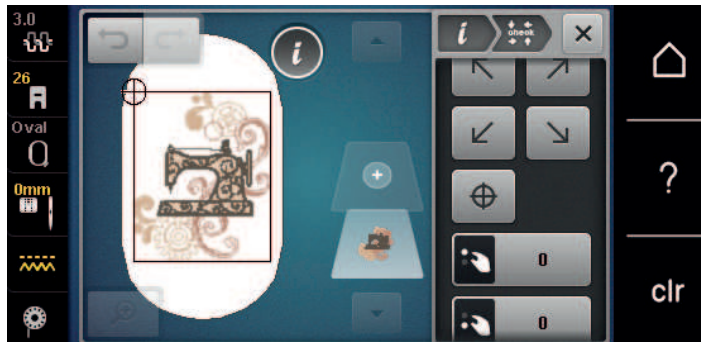

- > Touch the icon «Embroidery motif center» to bring the needle to the center of the embroidery motif.
- > Turn the «Upper Multifunctional knob» to move the embroidery motif horizontally.
- > Turn the «Lower Multifunctional knob» to move the embroidery motif vertically.

Endless embroidery

When embroidering a trim, it is advantageous to use the «Mega Hoop» (optional accessory). The embroidering project therefore does not have to be re-clamped as frequently. We recommend marking guide lines on the fabric and using the pattern when clamping and re-clamping in the hoop. In doing so, the guide lines must run parallel to the pattern. The following example uses the enclosed «Oval Hoop».

- > Select an embroidery motif.
- > Touch the icon «i»-Dialog.



- > Touch the icon «Embroider trims».
 - The embroidery motif is duplicated to the optimum number, suitable for the hoop.
 - The reference points, which are required when re-clamping the fabric, are inserted.



- > If required, use the arrow icons (1) to insert additional reference points.
- > Turn the «Upper multifunction knob» or touch the icons «-/+» (2) to set the number of embroidery motifs.
- > Turn the «Lower multifunction knob» or touch the icons «-/+» (3) to set the distance between the embroidery motifs.



- > Touch the icon «Adapt embroidery motif size to the hoop» (4) to automatically adapt all of the embroidery motifs to the hoop.



- > Touch the icon «Confirm».



- > Touch the icon «i»-Dialog.



- > Touch the icon «Embroidering».



- > Touch the icon «Start/Stop» and embroider the trim.
 - The embroidery motif must be embroidered already.

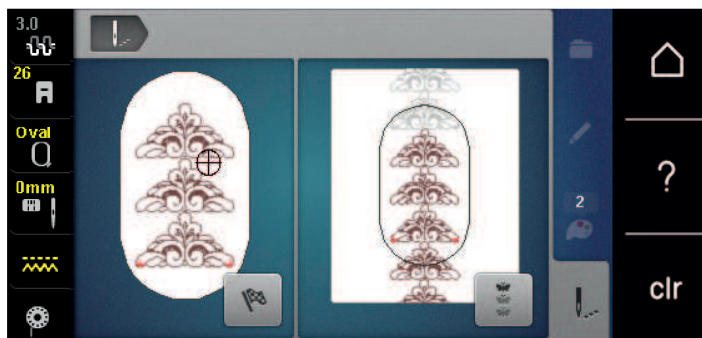



- > Touch the icon «Embroider trims» once the reference points have been embroidered.
 - An animation displays that the fabric has to be re-clamped.

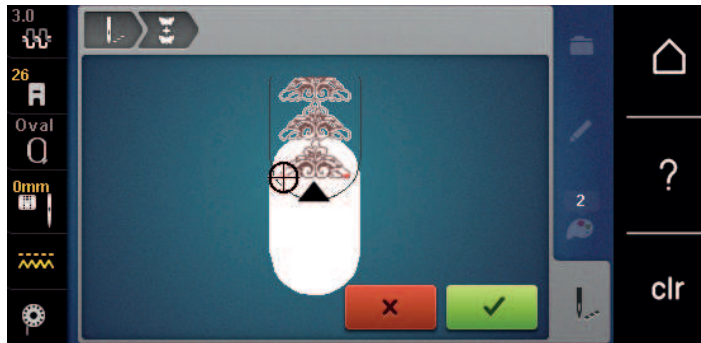

- > Remove the hoop and spin the fabric in such a way that the embroidered reference points are in the upper embroidery field of the hoop and the reference points are located at least 3 cm (1.18 inch) away from the upper edge of the hoop.
- > Attach the hoop.
- > Touch the icon «Confirm».
 - The hoop is automatically moved close to the reference point.
 - The icon «AUTO» is active and the hoop automatically moves close to the last reference point.
- > Use the arrow icons to determine the side of the embroidered section on which you want to position the next reference point.
- > Turn the «Upper multifunction knob» or «Lower multifunction knob» to precisely position the hoop.



- > Touch the icon «Confirm».



- > Press the button «Start/Stop» and continue to embroider.
- > Repeat these steps until the required length of the trim has been achieved.

Duplicating the embroidery motif

The active embroidery motif is duplicated.

- > Select an embroidery motif.
- > Touch the icon «i»-Dialog.





- > Touch the icon «Duplicate».
- The embroidery motif (1) is duplicated (2).

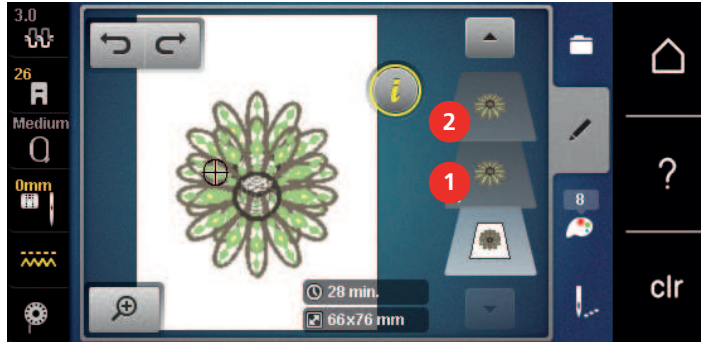

Deleting an embroidery motif

The active embroidery motif is deleted.



- > Select an embroidery motif.
- > Touch the icon «i»-Dialog.



- > Touch the icon «Delete».

Changing the sequence within an embroidery motif combination

The sequence of the embroidery motifs within the embroidery motif combination can be changed.

Prerequisite:

- The embroidery motif combination has been created or the motif has been ungrouped.



- > Select the desired embroidery motif which is to be repositioned.
- > Touch the icon «i»-Dialog.



- > Touch the icon «New Allocation».



- > Touch the icon «Scroll up» to position the selected embroidery motif further up within the sequence.



- > Touch the icon «Scroll down» to position the selected embroidery motif further down within the sequence.

Undoing entries

All entries can be undone and redone again step by step.

Prerequisite:

- An embroidery motif has been selected and alterations have been done.



- > Touch the icon «Undo» to cancel the last entry.
- > Touch the icon «Undo» several times to cancel the last entries step by step.

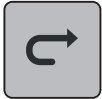

- > Touch the icon «Redo» to restore the last entry.
- > Touch the icon «Redo» several times to restore the last entries step by step.

Grouping embroidery motifs

Embroidery motifs can be added to or removed from a group. The grouped embroidery motifs can be processed in the same way as for one embroidery motif.

The sequence of the embroidery motifs in the group can be changed (see page 158).

If the grouping of an embroidery motif has been canceled, i.e. the embroidery motif has been broken down into different elements/colors, the colors are no longer combined for new groupings. With alphabets, the length of the connecting stitches must first be set to 1 in the setup. The cancellation of the group then works for all letters.

- > Create an embroidery motif combination.
- > Select the embroidery motif (1) in the embroidery motif combination.



- > Touch the icon «i»-Dialog.



- > Touch the icon «Grouping».



- > Touch the icon «Grouping».
- Embroidery motifs above the selected embroidery motif are added to the embroidery motif group.
- > Select the embroidery motif group.



- > Touch the icon «Expand grouping».
- The grouping is canceled.

or

- > Create an embroidery motif combination.
- > Select all embroidery motifs (2).





> Touch the icon «i»-Dialog.



> Touch the icon «Grouping».
– All embroidery motifs are added to the embroidery motif group.

> Select the embroidery motif group.

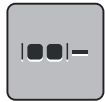

> Touch the icon «Expand grouping».
– The grouping is canceled.

15.6 Pinpoint placement

Positioning of grid points

This function allows the exact positioning of the embroidery motif on the fabric in an easy way. The positioning points can be placed in the grid.

Prerequisite:

- Any two points of the embroidery motif are marked with chalk or a water-soluble pen on the fabric. The place or the location where the embroidery motif is to be positioned is clearly visible.

> Select an embroidery motif.

> Touch the icon «i»-Dialog.



> Touch the icon «Pinpoint placement».

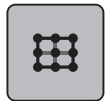

> Touch the icon «Grid».
– The embroidery motif is given a grid with nine different location/positioning points.

> Select the desired positioning point to which the embroidery motif is to be adjusted.
– The point changes its color.

> Turn the «Upper Multifunctional knob» or the «Lower Multifunctional knob» to the left or to the right to position the needle above the respective mark on the fabric.

> Touch the icon «SET» to confirm the altered position.
– The point changes its color and is defined.



> Select the second positioning point of the embroidery motif.

> Turn the «Upper Multifunctional knob» or the «Lower Multifunctional knob» to the left or to the right to position the needle above the respective mark on the fabric.



> Touch the icon «SET» to confirm the altered position.

– The point changes its color and is defined. The embroidery motif is adjusted accordingly.



- > Touch the icon «Reset Pinpoint placement» to reset the alterations to default setting.

Free point positioning

This function allows the exact positioning of the embroidery motif on the fabric in an easy way. The points can be defined as you like within the embroidery motif.

Prerequisite:

- Any two points of the embroidery motif are marked with chalk or a water-soluble pen on the fabric. The place or the location where the embroidery motif is to be positioned is clearly visible.

- > Select an embroidery motif.

- > Touch the icon «i»-Dialog.



- > Touch the icon «Pinpoint placement».



- > Touch the icon «Place points as desired».

- > Define a desired point within the embroidery motif.

- The positioning point is displayed.

- > Turn the «Upper Multifunctional knob» or the «Lower Multifunctional knob» to the left or to the right to position the needle above the respective mark on the fabric.

- > Touch the icon «SET» to confirm the altered position.

- The point changes its color and is defined.

- > Select the second positioning point of the embroidery motif.

- > Turn the «Upper Multifunctional knob» or the «Lower Multifunctional knob» to the left or to the right to position the needle above the respective mark on the fabric.



- > Touch the icon «SET» again to confirm the altered position.

- The point changes its color and is defined. The embroidery motif is adjusted accordingly.

- > Touch the icon «Reset Pinpoint placement» to reset the alterations to default setting.



15.7 Combining embroidery motifs

Combining embroidery motifs

In the Combi-Mode several embroidery motifs can be combined.

- > Select an embroidery motif.



- > Touch the icon «SET» again to confirm the altered position.
- The point changes its color and is defined. The embroidery motif is adjusted accordingly.

- > Touch the icon «Reset Pinpoint placement» to reset the alterations to default setting.



15.7 Combining embroidery motifs

Combining embroidery motifs

In the Combi-Mode several embroidery motifs can be combined.

- > Select an embroidery motif.



- > Touch the icon «Add an embroidery motif» (1).
- > Select another embroidery motif.

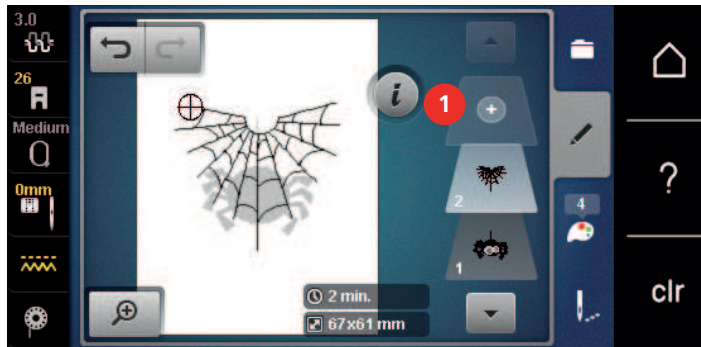

Deleting a single embroidery motif

Prerequisite:

- A combination of embroidery motifs has been created.
- > In the section of the embroidery motif level (1) touch the desired embroidery motif with the finger, keep it pressed and move it outwards.
 - A new window opens.

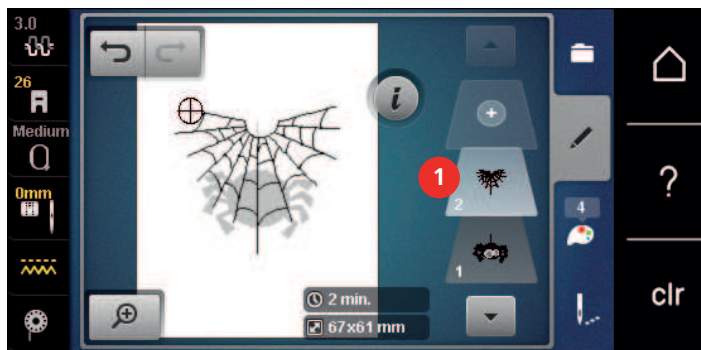

- > Touch the icon «Confirm» to delete the selected embroidery motif.

Duplicating a combination

When a combination is duplicated, the individual embroidery motifs cannot be selected anymore.

- > Select an embroidery motif.
- > Touch the icon «Add an embroidery motif».
- > Select another embroidery motif.
- > Select the combination (1).





> Touch the icon «i»-Dialog.



> Touch the icon «Duplicate».



– The combination is duplicated (2).

15.8 Creating lettering

Overview embroidery alphabets

Embroidery motif	Name
ABC	Swiss Block
<i>ABC</i>	Anniversary
ABC	Guinevere
ABC	Drifter
ABC	Childs Play
АБВ	Russian Textbook
<i>ABC</i>	Curly
ABC	Rounded Sans

Creating words/sentences



Lettering is always embroidered in one color. To embroider single letters or single words in another color, every letter or every word has to be selected individually and placed in the area to be embroidered.

Lettering can be positioned within the hoop as you like. When the embroidery motif is positioned outside the embroidering area, the hoop is outlined in red on the display. With the hoop selection it can be checked whether or not the embroidery motif can be embroidered in another hoop. When the lettering does not fit in any hoop, two single words can be combined and positioned below each other as the following example will show.



- > Select the file «Alphabets».
- > Select the font.
- > Enter the text «Made to».
- > Touch the icon (1) (standard setting) to use upper case letters.
- > Touch the icon (2) to use lower case letters.
- > Touch the icon (3) to use numbers and mathematic characters.
- > Touch the icon (4) to use special characters.



- > Touch the text box above the keyboard to delete the entered text completely.
- > Touch the icon «DEL» to delete single letters of the entered text.



- > Touch the icon «Confirm» to accept the text.



- > Touch the icon «Embroidery hoop display/Embroidery hoop selection».
- > Select the hoop.
- > Touch the icon «Embroidery hoop display/Embroidery hoop selection» again to go back to the Edit Mode.

Editing words/sentences



- > Touch the icon «i»-Dialog.



- > Touch the icon «Rotate the motif».



- > Touch the icon «+90» to rotate the text by 90°.
- > Touch the icon «i» (1).



- > Touch the icon «Move the stitch pattern».
- > Turn the «Upper Multifunctional knob» to move the embroidery motif horizontally.

> Turn the «Lower Multifunctional knob» to move the embroidery motif vertically.



> Touch the icon «Add motif».
> Enter and also rotate the text «create».



> Touch the icon «Embroidery hoop display/Embroidery hoop selection».

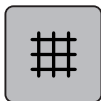

> Touch the icon «Grid on/off» to position the text lines more exactly.

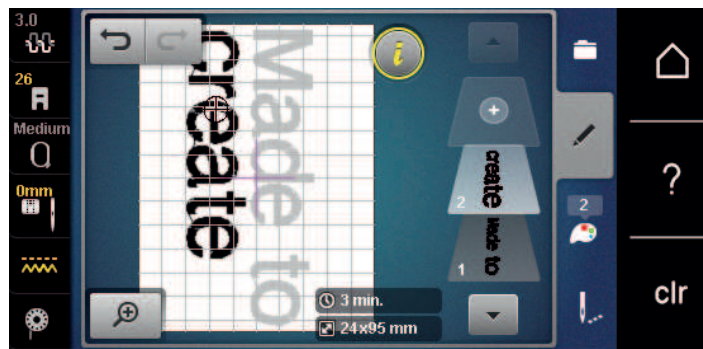

15.9 Changing the colors of the embroidery motif

Overview changing the color

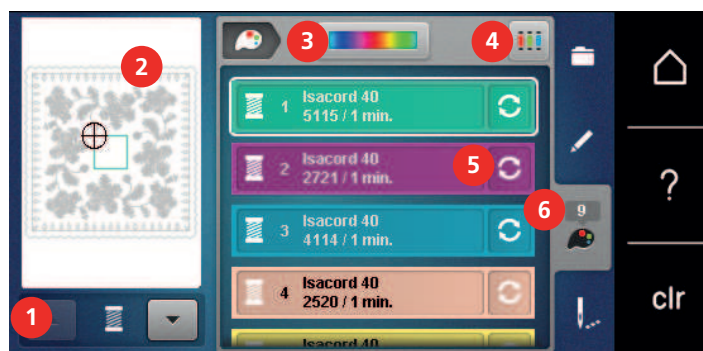

- | | | | |
|---|-----------------------------|---|-------------------------|
| 1 | Colors of embroidery motifs | 4 | Allocating thread brand |
| 2 | Preview for selected color | 5 | Altering color/brand |
| 3 | Color wheel | 6 | Color information |

Changing the colors

> Select an embroidery motif.



> Touch the icon «Color information».

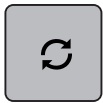

> Touch the icon «Change color/manufacture» beside the color that you want to change.
 > To display additional colors, swipe up or down on the display.



> To select the color by entering the color number, touch the icon «Color selection by number».
 > Enter the number for the required color.
 – The color icon is displayed on the left.
 > To confirm the color selection, touch the color icon that is displayed on the left.

Altering the colors via the color wheel



> Touch the icon «Color information».
 > Touch the icon «Color wheel» (1).

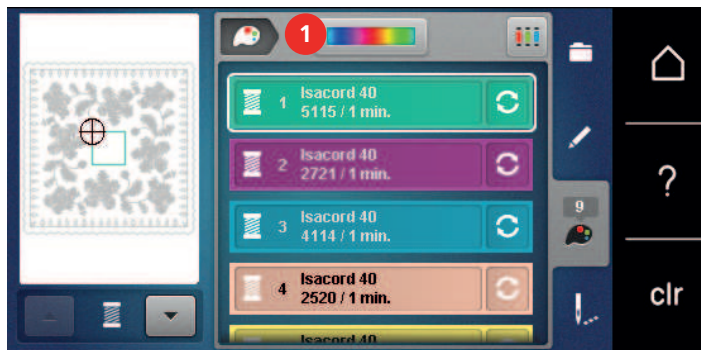

> Turn the round knob (2) with the the touchscreen pen/finger clockwise or counter-clockwise or turn the «Upper Multifunction knob» to alter the colors of the embroidery motif.



> Move the slide (3) with the the touchscreen pen/finger to alter the brightness of the colors.





- > Touch the icon «Edit».
- The embroidery motif appears in the new colors.

Changing the thread brand



- > Select the embroidery motif.
- > Touch the icon «Color information».

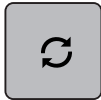

- > Touch the icon «Alter color/brand».



- > To show more thread brands, touch the icons «Scroll left» and «Scroll rights» in the upper part of the screen.



- > Touch the icon «Allocate thread brand».
- Any thread colors of the selected embroidery motif will be matched with the selected thread brand.

15.10 Embroidering the embroidery motif

Overview Embroidery menu



- | | | | |
|---|--|---|--|
| 1 | Basting | 6 | Increasing the embroidery speed (appears by scrolling) |
| 2 | Moving the hoop | 7 | Reducing color changes (appears by scrolling) |
| 3 | Embroidery sequence control when thread breaks | 8 | Endless Embroidery (appears by scrolling) |
| 4 | Cutting connecting stitches | 9 | Color indication |
| 5 | Multi-colored embroidery motif on/off (appears by scrolling) | | |

Adding basting stitches

The basting stitches can be embroidered along the embroidery hoop or along the embroidery motif. Therefore the connection between the fabric and the stabilizer can be improved.



- > Select an embroidery motif.
- > Touch the icon «Embroidering».



- > Touch the icon «Basting» to embroider basting stitches along the embroidery motif.
- > Touch the icon «Basting» again to embroider basting stitches along the embroidery hoop.
- > Touch the icon «Basting» again to deactivate the basting stitches.

Moving the hoop

If the embroidery motif is so big that repeated rehooping is necessary, the embroidered motif can be moved again.



- > Select an embroidery motif.
- > Touch the icon «Embroidering».



- > Touch the icon «Move the hoop».
- > Turn the «Upper Multifunctional knob» to move the hoop horizontally.
- > Turn the «Lower Multifunctional knob» to move the hoop vertically.



- > Touch the icon «Embroidering» in the process navigation to accept the settings.

Embroidery sequence control when thread breaks

When the thread breaks, the needle can be repositioned in the embroidery motif by means of the embroidery sequence control.



- > Select an embroidery motif.
- > Touch the icon «Embroidering».



- > Touch the icon «Embroidery sequence control when thread breaks».
 - In the left portion of the display a compact view of the embroidery motif is displayed. On the right side the enlarged embroidery motif is displayed.
- > Select the desired position in the compact view using the touchscreen pen/finger.
- > Turn the «Upper Multifunctional knob» to move the hoop stitch by stitch.
- > Turn the «Lower Multifunctional knob» to move the hoop in large steps.
 - The number in the yellow-framed icon indicates the number of stitches within the embroidery sequence.



- > Touch the icon «Magnifier» to select the desired stitch via entry.

Cutting connecting stitches

The function is activated by default and the connecting stitches are cut automatically. When the function is deactivated, the connecting stitches between the embroidery motifs must be cut manually.



- > Select an embroidery motif.
- > Touch the icon «Embroidering».



- > Touch the yellow-framed icon «Cut the connecting stitches» to deactivate the function.
- > Touch the yellow-framed icon «Cut the connecting stitches» again to activate the function.

Reducing color changes

When the embroidery motifs overlap, the color changes **cannot** be reduced.

- > Select an embroidery motif.
- > Touch the icon «Embroidering».



- > Touch the icon «Reduce thread change».
- Identical colors of the embroidery motif are collected to one color.



Multi-colored embroidery motif on/off

Multi-colored embroidery motifs can also be embroidered in one color.

- > Select an embroidery motif.
- > Touch the icon «Embroidering».



- > Touch the icon «Multi-colored embroidery motif on/off».
- The embroidery motif is embroidered in one color.



Endless Embroidery

This makes it possible to embroider trims that have already been started, even if the machine has been switched off and on.

Prerequisite:

- A trim embroidery motif must be saved on a separate storage medium. The reference points must be included in the embroidery motif.

- > Select trim embroidery motifs from the separate storage medium.
- > Touch the icon «Embroidering».



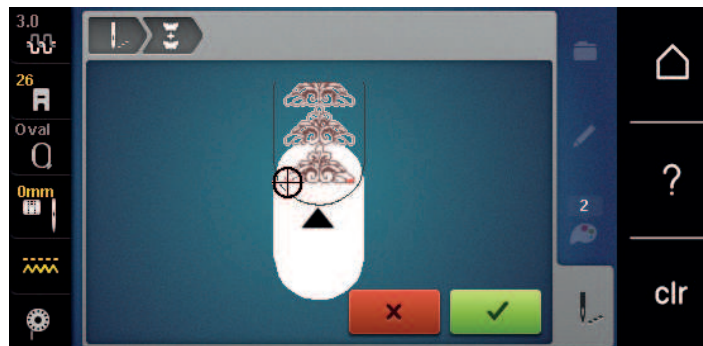

- > The icon «Embroider trims» becomes visible if you scroll upwards in the right-hand toolbar.
- > Touch the icon «Embroider trims».



- > Remove the hoop and spin the fabric in such a way that the embroidered reference points are in the upper embroidery field of the hoop and the reference points are located at least 3 cm (1.18 inch) away from the upper edge of the hoop.
- > Attach the hoop.

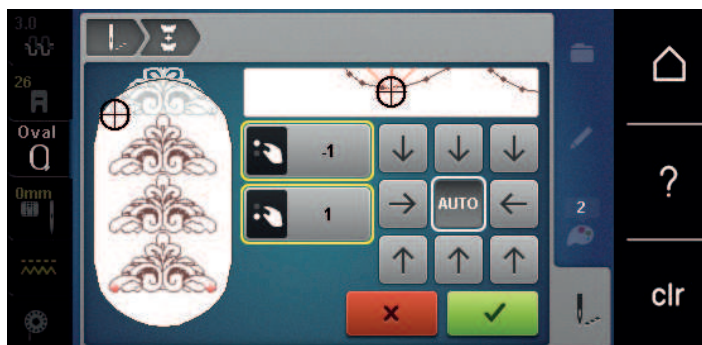

- > Touch the icon «Confirm».
 - The hoop is automatically moved close to the last stitch.
 - The icon «AUTO» is active and the hoop automatically moves close to the last reference point.
- > Use the arrow icons to determine the side of the embroidered section on which you want to position the next reference point.
- > Turn the «Upper multifunction knob» or «Lower multifunction knob» to precisely position the hoop.



- > Touch the icon «Confirm».
-  > Press the button «Start/Stop» and continue to embroider.
- > Repeat these steps until the required length of the trim has been achieved.

Color indication

Every color of the embroidery motif can be selected individually. The hoop moves to the first stitch of the current color. The currently active color can be embroidered individually or in another sequence.

- > Select an embroidery motif.
- > Touch the icon «Embroidering».
-  > Touch the icon «Embroidering».
-  > Touch the icon «Scroll down» to select the next color of the embroidery motif.
-  > Touch the icon «Scroll up» to select the previous color of the embroidery motif.

15.11 Free arm embroidering

Free arm embroidering is defined as embroidering tubular fabrics or garments which are positioned around the free arm of the embroidery machine while being embroidered. Often used with sleeves, pant legs or other narrow-tailored garments.



A tubular piece of fabric can be pulled over the free arm of the machine easily when the free arm is positioned to the left in parking position before the hoop is attached or removed. Push the button «Start/Stop» to move the embroidery hoop back to the embroidery position again.

Make sure to use a full bobbin as the embroidery hoop needs to be removed for changing the bobbin.

Borders can be closed to a ring easily and exactly along the edge of the tube. Before embroidering the last embroidery motif, after rehooping the fabric, activate the function «Pinpoint placement» in the edit mode. Using the subfunction «Free point positioning» align the still missing embroidery motif precisely.

The movability of the embroidery arm can be limited or impeded with very narrow tubes. Therefore please make sure that the embroidery hoop can move forwards and backwards sufficiently. An impediment of the embroidery arm caused by a tube which is too tight can result in embroidery motif offset or in damaging the fabric.

Check the movability of the free arm

Please note: With tiny fabric tubes, deactivate the thread-away in the Setup Program if necessary.

- > Open the embroidery motif on the machine and edit as desired.
- > Mark the embroidery motif position and the size on the fabric in a suitable way.
- > Select the embroidery hoop as small as possible.
- > Hoop or stick the fabric along with the appropriate stabilizer in the embroidery hoop, depending on the stabilizer.
- > Pull the fabric tube carefully over the free arm of the machine and attach the embroidery hoop at the clutch of the embroidery module.
- > If necessary, reposition the embroidery motif.
- > Previously check whether the embroidery hoop can be moved forwards and backwards according to the embroidery motif size.
- > Touch the icon «Check embroidery motif size».
- > After the successful check of the embroidery motif size, start the embroidery process.

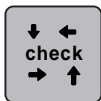

Detailed instructions about embroidery, the use of suitable materials or selecting the required embroidery settings of the machine can be found in the «Tutorial» under embroidery techniques --> Embroidering.

15.12 Administering embroidery motifs

Administering embroidery motifs

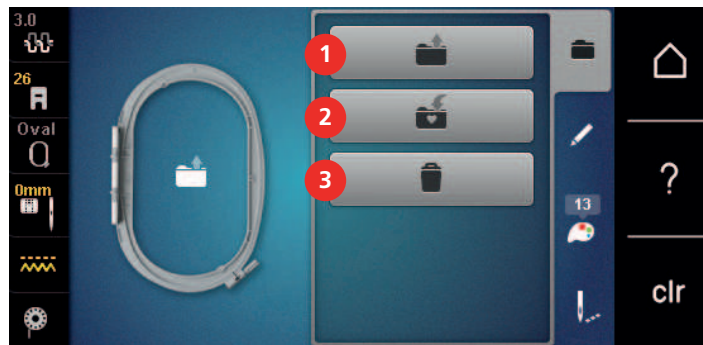

- | | | | |
|---|------------------------------|---|----------|
| 1 | Loading the embroidery motif | 3 | Deleting |
| 2 | Saving the embroidery motif | | |

Saving embroidery motifs in the personal memory

In the filing system «Personal memory» any stitch patterns, also those which have been individually edited, can be saved.

- > Select an embroidery motif.
- > Edit the embroidery motif.
- > Touch the icon «Selection».



- > Touch the icon «Save the motif».
 - The embroidery motif to be saved is outlined in yellow.
 - The icon «Embroidery machine» is activated.



- > Touch the icon «Confirm».

Saving the embroidery motif on the BERNINA USB stick

- > Select an embroidery motif.
- > Edit the embroidery motif.
- > Touch the icon «Selection».



- > Touch the icon «Save the motif».
 - The embroidery motif to be saved is outlined in yellow.



- > Insert the BERNINA USB stick into the USB port of the machine.



- > Touch the icon «USB stick».



- > Touch the icon «Confirm».

Overwriting the embroidery motif in the personal memory

- > Select an embroidery motif.
- > Edit the embroidery motif.
- > Touch the icon «Selection».



- > Touch the icon «Save the motif».
 - The embroidery motif to be saved is outlined in yellow.



- Touch the icon «Embroidery machine» is activated.



- > Select the embroidery motif which is to be overwritten.



- > Touch the icon «Confirm».

Overwriting the embroidery motif on the BERNINA USB stick

- > Select an embroidery motif.
- > Edit the embroidery motif.
- > Touch the icon «Selection».



- > Touch the icon «Save the motif».
 - The embroidery motif to be saved is outlined in yellow.



- > Insert the BERNINA USB stick into the USB port of the machine.



- > Touch the icon «USB stick».

- > Select the embroidery motif which is to be overwritten.



- > Touch the icon «Confirm».

Importing stitch patterns

Stitch patterns or stitch pattern combinations can be imported from the Sewing mode to the Embroidery mode and edited like embroidery motifs. Therefore endless embroidery can be combined quickly and easily and saved as an embroidery motif in the file «Personal embroidery motifs».



- > Touch the icon «Home».



- > Touch the icon «Sewing mode».
- > Select a stitch pattern.



> Touch the icon «Home».



> Touch the icon «Embroidery mode».
– The stitch pattern is saved automatically in the file «Personal embroidery motifs».



> Select the file «Personal embroidery motifs».
> Select an embroidery motif.

Loading an embroidery motif from the personal memory



> Touch the icon «Selection».



> Touch the icon «Upload embroidery motif».



> Select the file «Personal embroidery motifs».
> Select an embroidery motif.

Loading an embroidery motif from the BERNINA USB stick



> Touch the icon «Selection».
> Insert the BERNINA USB stick into the USB port of the machine.



> Touch the icon «USB stick».
> Select a personal embroidery motif.

Deleting an embroidery motif from the personal memory

The embroidery motifs which are saved in the personal memory can be deleted individually.

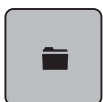

> Touch the icon «i»-Dialog.



> Touch the icon «Delete».



– Touch the icon «Embroidery machine» is activated.

> Select the embroidery motif which is to be deleted.



> Touch the icon «Confirm».

Deleting an embroidery motif from the BERNINA USB stick

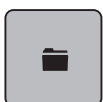

> Touch the icon «Selection».



> Touch the icon «Delete».
> Insert the BERNINA USB stick into the USB port of the machine.



> Touch the icon «USB stick».
> Select the embroidery motif which is to be deleted.



> Touch the icon «Confirm».

16 Embroidery

16.1 Embroidering via the button «Start/Stop»

In case of a power cut the embroidery process is interrupted. After the restart the machine goes to the position which was embroidered last.



- > Push the button «Start/Stop» to start the embroidery machine.
 - All parts of the motif being in the current color are embroidered.
 - The embroidery machine stops automatically at the end.
 - Both threads are cut automatically.
 - The embroidery machine switches to the next color automatically.



- > Change the upper thread.
- > Push the button «Start/Stop» to embroider the new color.
- > After completing the embroidery motif, finish the embroidering process by touching the icon «Finishing the embroidering process» (1) or embroider the motif again by touching the icon «Endless embroidery»(2).

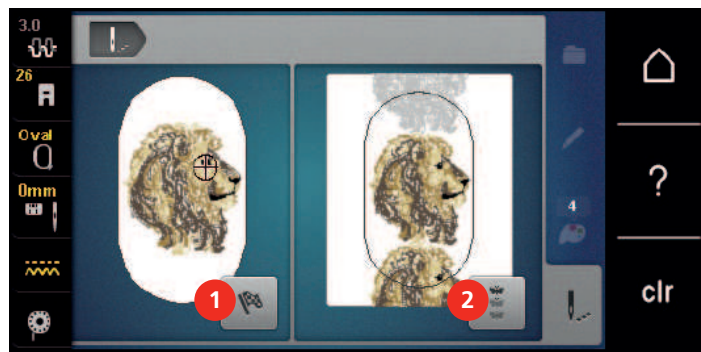

16.2 Increasing the embroidery speed

To ensure the best embroidery quality, the speed when embroidering is reduced depending on the embroidery position. Choose between the two options to either embroider at optimal or maximum speed. Standard = optimal speed. It has to be considered that the quality of the embroidered embroidery motif at maximum speed cannot be ensured.

By switching the machine off and on, the optimal embroidery speed is activated.

Prerequisite:

- The embroidery motif is selected.



- > Touch the icon «Embroidery speed».
 - The maximum speed is activated.
- > Touch the icon «Embroidery speed» again.
 - The optimal speed is activated.

16.3 Adjusting the upper thread tension

The basic setting of the upper thread tension is provided automatically as soon as a stitch pattern or an embroidery motif is selected.

The upper thread tension is set optimally at the BERNINA factory and the machine has been tested. Metrosene-/Seralon thread size 100/2 (Company Mettler, Switzerland) is used for upper and bobbin thread.

When of using other types of sewing or embroidery threads, the optimal tension may vary. Therefore it may be necessary to adjust the upper thread tension according to the sewing or embroidering project as well as the desired stitch pattern or the embroidery motif individually.

The higher the upper thread tension, the tighter the upper thread which means that the bobbin thread is pulled up to the top of the fabric. When the upper thread tension is low, the upper thread is less tightened which means that the bobbin thread is pulled up less.

Alterations of the upper thread tension affect the currently selected stitch pattern or embroidery motif. Permanent alterations of the upper thread tension for the sewing mode (see page 48) and for the embroidering mode (see page 53) can be made in the Setup Program.

Prerequisite:

- In the Setup Program the upper thread tension has been altered.
- > Touch the icon «Upper thread tension».
- > Move the slide using the touchscreen pen/finger to increase or reduce the upper thread tension.



- > Touch the yellow-framed icon on the right side to reset the alteration to default setting.
- > Touch the yellow-framed icon on the left side to reset the alteration to default setting in the **Setup Program**.

16.4 Embroidering via the foot control

Embroidering via the foot control is recommended when only a short sequence has to be embroidered. While embroidering, the foot control must be pressed down all the time.

- > Press the foot control to start embroidering.

17 Appendix

17.1 Maintenance and cleaning

Cleaning the display

- > Clean the display in the switched off status with a soft slightly damp microfiber cloth.

Cleaning the feed dog

Remove the thread remnants under the stitch plate regularly.



Electronically driven components

Risk of injury near the needle and the hook.

- > Raise the presser foot.
- > Switch the machine off and disconnect it from the power supply system.

- > Remove the presser foot and the needle.
- > Lower feed dog.



- > Remove the stitch plate.
- > Clean the feed dog with the brush.

Cleaning the hook



Electronically driven components

Risk of injury near the needle and the hook.

- > Switch the machine off and disconnect it from the power supply system.

- > Open the bobbin cover.
- > Remove the bobbin case.
- > Push the fastening bracket to the left.

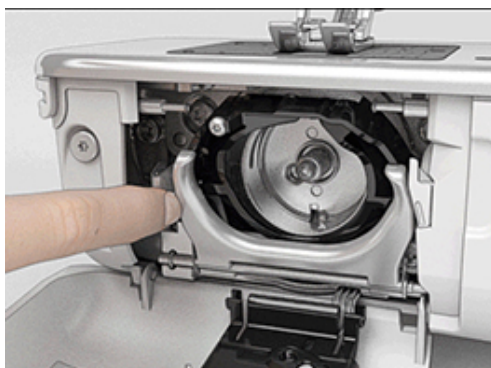

- > Flap down the fastening bracket along with the black hook race cover.

- > Remove the hook.

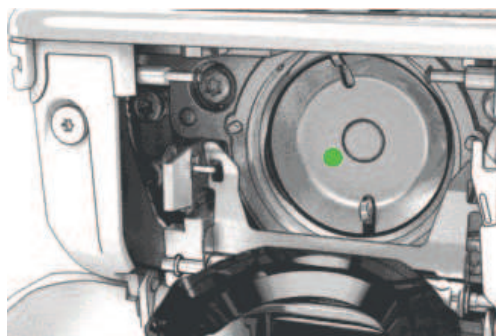

- > Clean the hook race area with the brush; never use a sharp instrument.
- > Hold the hook at the pin in the center with two fingers.
- > Lead the hook, lower edge ahead, angular top-down behind the hook race cover.
- > Position the hook with the two lugs meeting the openings in the hook, the colored mark on the hook driver should be visible through the hole in the hook.
- > Insert the hook.
 - The hook is magnetic and therefore fastened to the correct position.
- > Close the hook race cover and the fastening bracket until the release bracket engages.
- > As a check, turn the handwheel.
- > Insert the bobbin case.

Lubricating the hook



CAUTION

Electronically driven components

Risk of injury near the needle and the hook.

- > Switch the machine off and disconnect it from the power supply system.

NOTICE

Lubricating the hook

Too much oil can pollute the fabric and the thread.

- > After lubricating, sew/embroider a test piece first.

- > Remove the bobbin case.
- > Push the fastening bracket to the left.

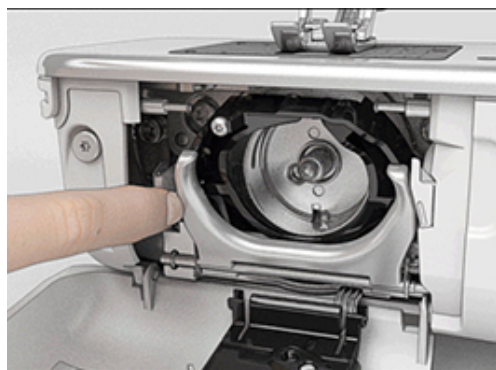

- > Flap down the fastening bracket along with the black hook race cover.

- > Remove the hook.

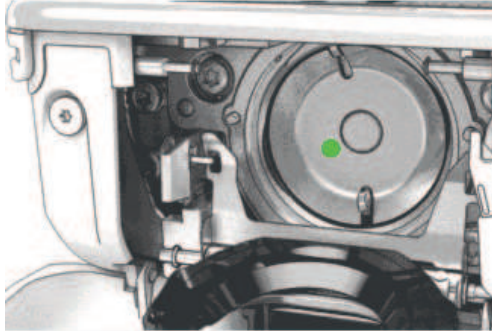

- > Give one drop of BERNINA oil down in the hook race.



- > Give one drop of oil in each of the two oil depots so that the felts are damp and make sure that the red-marked surface of the hook sleeve remains free of oil.



- > Hold the hook at the pin in the center with two fingers.
- > Lead the hook, lower edge ahead, angular top-down behind the hook race cover.
- > Position the hook with the two lugs meeting the openings in the hook, the colored mark on the hook driver should be visible through the hole in the hook.
- > Insert the hook.
 - The hook is magnetic and therefore fastened to the correct position.
- > Close the hook race cover and the fastening bracket until the release bracket engages.
- > As a check, turn the handwheel.
- > Insert the bobbin case.



17.2 Troubleshooting





Fault	Cause	Solution
Uneven stitch formation	Upper thread too tight or too loose.	> Adjust the upper thread tension.
	Needle blunt or bent.	> Replace the needle, make sure that a new BERNINA quality needle is used.
	Poor quality needle.	> Use a new BERNINA quality needle.
	Poor quality thread.	> Use quality thread.
	Incorrect needle/thread combination.	> Match the needle with the thread size.
	Incorrectly threaded.	> Rethread.
	The fabric has been pulled.	> Feed the fabric evenly.
Uneven stitch formation	Incorrect bobbin case is used.	> Use the supplied bobbin case marked with the triangle.
		
Skipped stitches	Incorrect needle.	> Use the needle system 130/705H.
	Needle blunt or bent.	> Replace the needle.
	Poor quality needle.	> Use a new BERNINA quality needle.
	The needle is incorrectly inserted.	> Insert the needle with the flat side to the back as far up as it will go into the needle holder and tighten the screw.
	Incorrect needle point.	> Match the needle point to the texture of the material.
Faulty stitching	Thread remnants between the thread tension discs.	> Fold a piece of thin material and slide the folded edge (not the raw edges) between the thread tension discs.
	Incorrectly threaded.	> Rethread.
	Thread remnants below the bobbin case spring.	> Remove the thread remnants under the spring.

Fault	Cause	Solution
Upper thread breaks	Incorrect needle/thread combination.	> Match the needle with the thread size.
	Upper thread is too tight.	> Reduce the upper thread tension.
	Incorrectly threaded.	> Rethread.
	Poor quality thread.	> Use quality thread.
	The stitch plate or the hook tip is damaged.	> Contact the nearest specialized BERNINA dealer to have the damages repaired. > Replace the stitch plate.
	The thread is caught in the area of the thread take-up lever.	> Slide the headframe (1) to the left, then remove it. > Remove the thread remnants. > Insert the 4 knobs of the headframe into the provided notches and slide the headframe to the right.
		
Lower thread breaks	The bobbin case is damaged.	> Replace the bobbin case.
	The stitch hole in the stitch plate is damaged.	> Contact the nearest specialized BERNINA dealer to have the damages repaired. > Replace the stitch plate.
	Needle blunt or bent.	> Replace the needle.
Needle breaks	The needle is incorrectly inserted.	> Insert the needle with the flat side to the back as far up as it will go into the needle holder and tighten the screw.
	The fabric has been pulled.	> Feed the fabric evenly.
	Thick fabric has been pushed.	> Use the appropriate presser foot, e.g. Jeans foot No. 8 for thick material. > Use the height compensating tool when sewing over a thick seam.
	Knotted thread.	> Use quality thread.
Stitch width not adjustable	The selected needle and stitch plate cannot be used in combination.	> Replace the needle. > Replace the stitch plate.
Speed too low	Unfavorable room temperature.	> Place the machine in a warm room one hour before use.
	Settings in the Setup Program.	> Adjust the sewing speed in the Setup Program. > Adjust the slide.

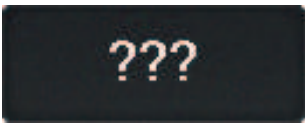
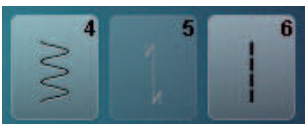

Fault	Cause	Solution
The machine doesn't start	Unfavorable room temperature.	> Place the machine in a warm room one hour before use. > Connect the machine and switch it on.
	The machine is damaged.	> Contact the specialized BERNINA dealer.
Neither the sewing light nor the light on the free arm lights up	Settings in the Setup Program.	> Activate it in the Setup Program.
	The sewing light is defect.	> Contact the specialized BERNINA dealer.
Upper thread indicator doesn't react	Settings in the Setup Program.	> Activate it in the Setup Program.
	The upper thread indicator is defect.	> Contact the specialized BERNINA dealer.
Bobbin thread indicator doesn't react	Settings in the Setup Program.	> Activate it in the Setup Program.
	The bobbin thread indicator is defect.	> Contact the specialized BERNINA dealer.
Error during software update	USB stick is not recognized.	> Use a BERNINA USB stick.
	The update process is blocked and the hourglass on the display is inactive.	> Remove the USB stick. > Switch the machine off. > Switch the machine on. > Follow the instruction on the display.
	Date of the software update cannot be found.	> Unzip the update data. > Save data of the software update directly on the data medium and not in a file on the USB stick.
BSR presser foot #42 not detected	Lens is dirty.	> Clean the lens with a soft, slightly damp cloth.
	BSR cable not inserted correctly.	> Insert the BSR connector vertically until you feel it click into place.

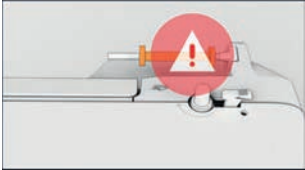
17.3 Error messages

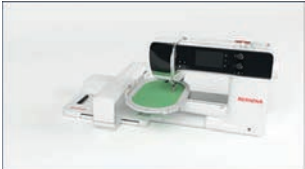
Message on the display	Cause	Solution
	Stitch number unknown.	> Check the entry and enter the new number.
	Selection of the stitch pattern not possible in the combi mode.	> Combine other stitches.

Message on the display	Cause	Solution
	The feed dog is not lowered.	> Push the button «Feed dog up/down» to lower the feed dog.
	The selected needle and stitch plate cannot be used in combination.	> Replace the needle. > Replace the stitch plate.
	The needle is not at its top end.	> Adjust the needle position via the handwheel.
	The upper thread is used up.	> Rethread.
	The upper thread has broken.	> Rethread.
	The bobbin thread is used up.	> Rethread.
	The bobbin thread has broken.	> Clean the hook. > Rethread.
	The main motor isn't running.	> Turn the handwheel clockwise until the needle is at its top position. > Remove the stitch plate. > Remove the thread remnants. > Clean the hook. > Remove the hook and make sure that there are no pieces of broken needle points on the magnetic back of the hook.
	The contact between the machine and the embroidery module is interrupted due to vibrations.	> Make sure that the module and the machine are standing on a stable, even surface. > Connect the embroidery module to the machine.

Message on the display	Cause	Solution
	The needle position doesn't correspond with the center of the hoop.	> Calibrate the hoop.
	The embroidery module is not attached.	<ul style="list-style-type: none"> > Connect the embroidery module to the machine. > Contact the specialized BERNINA dealer to have the machine checked.
	The hoop is not attached.	> Attach the hoop.
	The hoop is attached.	> Remove the hoop.
	The movement of the hoop follows.	> Touch the icon «Confirm».
	Mega Hoop top.	> Bring the Mega Hoop to the top position.
	Mega Hoop center.	> Bring the Mega Hoop to the center position.

Message on the display	Cause	Solution
	Mega Hoop bottom.	> Bring the Mega Hoop to the lower position.
	The embroidery motif is partly outside the hoop.	> Reposition the embroidery motif and start embroidering it again.
	The embroidery motif is too large.	> Reduce the size of the embroidery motif. > Attach a larger embroidery hoop.
Too less free capacity on the BERNINA USB stick (optional accessory).	Not enough free capacity on the BERNINA USB stick (optional accessory).	> Make sure that the BERNINA USB stick (optional accessory) is used. > Delete data from the BERNINA USB stick (optional accessory).
No personal data on the BERNINA USB stick (optional accessory).	No personal data for recovery available on the BERNINA USB stick (optional accessory).	> Make sure that the data and settings have been saved on the BERNINA USB stick (optional accessory).
The recovery of personal data has failed.	The software update has been successful but the personal data couldn't be recovered.	> Make sure that the data and settings have been saved on the BERNINA USB stick (optional accessory). > Transfer saved data to the machine.
No BERNINA USB stick is inserted. Make sure that during the complete automatic update always the same BERNINA USB stick remains inserted.	The BERNINA USB stick (optional accessory) is not inserted.	> Use a BERNINA USB stick (optional accessory) providing enough free capacity.
The update of the software has failed.	The latest software version cannot be found on the USB stick.	> Make sure that the compressed zip file has been unzipped for the software update. > Check whether the data for the software update are saved directly on the data medium and not in a file on the USB stick. > Update the software.

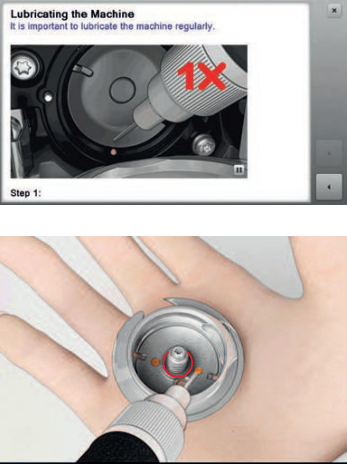
Message on the display	Cause	Solution
	<p>The machine needs cleaning/lubricating.</p>	<ul style="list-style-type: none"> > Clean the machine. > Lubricate the hook. <p>Important information on lubricating: Too much oil can pollute the fabric and the thread.</p> <ul style="list-style-type: none"> > After lubricating, sew/embroider a test piece first.
<p>The automatic thread cutter (at the thread catcher) needs cleaning.</p>	<p>The automatic thread cutter needs cleaning. The message appears every time when the machine is started as soon as 1000 cutting cycles have been carried out.</p>	<ul style="list-style-type: none"> > Touch the icon «Confirm». <ul style="list-style-type: none"> – The machine calls up the function «Clean the thread catcher». > Clean the thread catcher according to the instructions on the display. <ul style="list-style-type: none"> – The counter for the cutting cycles is reset.
<p>It is time for the regular maintenance. Please contact your specialized BERNINA dealer to make an appointment.</p>	<p>The machine needs maintenance. The message appears after the programmed service interval has expired.</p> <p>Important information: Having your machine cleaned and serviced properly at the appropriate times ensures its proper functioning and a long service life. Ignoring the terms can affect the operating life and restrict the guaranteeing. The cost allocation for maintenance work is regulated nationally. Consult your specialised dealer or your servicing shop for more details.</p>	<ul style="list-style-type: none"> > Contact the specialized BERNINA dealer. > Delete the message temporarily by touching the icon «ESC». <p>Having cleared the message three times, the message will appear as recently as the next service interval has been completed.</p>

17.4 Storage and disposal

Storing the machine

It is recommended to store the machine in the original packaging. If the machine is stored in a cold room, place it in a warm room one hour before use.

- > Switch the machine off and disconnect it from the power supply system.
- > Don't store the machine outdoor.
- > Protect the machine against climatic influences.

Dispose of the machine

- > Clean the machine.
- > Sort the components by their materials and dispose of them according to the local laws and regulations.

17.5 Technical data

Designation	Value	Unit
Maximum fabric thickness	10.5 (0.41)	mm (inch)
Sewing light	12 to 16	LED
Maximum speed	1000	Stitches per minute
Measurements without the spool pin (W x H x D)	465 x 330 x 200 (18.30 x 12.99 x 7.87)	mm (inch)
Weight	11.5	kg
Energy consumption	90	W
Input voltage	100 – 240	V
Protection class (Electrical engineering)	II	
Production date: To be seen on the type label under «Code».		

18 Overview stitch patterns

18.1 Overview Stitch patterns

Practical stitches

1	2	3	4	5	6	7	8	9	10	11
12	13	14	15	16	17	18	19	20	21	22
23	24	25	26	27	29	31	32	33	34	35
36	37	38	39	40						

Buttonholes

51	52	53	54	55	56	57	58	59	63	64
65	67	68	69	70	60	61	62			

Decorative stitches

Natural stitches

101	102	103	104	106	107	108	109	110	111	112
113	114	115	116	117	118	119	120	122	123	124

125	126	127	128	129	130	131	132	136	137	138
139	140	141	142	143	144	145	146	147	148	150
152	153	154	155	156	158	159	160	161	165	166
167	168	169	170	171	172	173	174	175	176	177
178	179	180	181	182	183	184	185			

Cross stitches

301	302	303	304	305	306	307	308	309	311	314
319	320	321	322	323	324	325	326	327	328	329
330	331	332	333	334	335	336	337	338	339	371
372	373	374	375	376	377	378				

Satin stitches

401	402	405	406	407	408	409	410	412	413	414

415	416	417	418	419	421	422	423	424	425	426
427	428	429	431	433	434	437	438	440	442	443
444	445	447	448	449	450	451	452	453	454	455
456	457	458	461	464	465	466	467	468	469	471
472	473									

Embellishment

601	602	603	604	605	606	607	608	609	610	611
612	613	614	615	616	618	619	620	621	622	623
624	625	626	627	628	629	630	631	632	633	634
635	636	637	639	640	641	642	643	644	645	646
647	648	649	650	651	652	653	654	655	656	657
658	660	661	662	663	664	665	666	674	675	676

677	678	679	680	682	683	684	685	686	691	693
694										

Heirloom stitches

701	702	703	704	705	706	707	708	709	710	711
712	713	714	715	716	717	721	722	723	724	725
726	727	729	730	731	732	733	734	735	736	737
738	739	740	741	742	743	744	745	746	747	748
749	750	751	752	755	756	757	758	759	762	763
764	765	766	767	768	769	770	771	772	773	774
775	776	777	778	779	780	781	782	783		

Novelty

901	902	903	904	905	906	907	908	909	910	911

912	913	914	915	916	917	918	919	920	921	922
924	926	928	929	935	937	938	939	940	944	945
946	948	949	950	952	954	955	957	958	959	960
961	962									

Special stitches

1101	1102	1103	1104	1105	1106	1107	1108	1109	1110	1113
1115	1116	1121	1122	1124						

Quilt stitches

1301	1302	1303	1304	1305	1306	1307	1308	1309	1310	1311
				$\frac{6}{\text{Inch}}$ $\frac{2.4}{\text{cm}}$	$\frac{8}{\text{Inch}}$ $\frac{3.2}{\text{cm}}$	$\frac{10}{\text{Inch}}$ $\frac{4}{\text{cm}}$	irregular look			
1312	1313	1314	1315	1316	1317	1318	1319	1320	1321	1322
1323	1324	1325	1326	1327	1329	1330	1331	1332	1333	1334
1335	1336	1337	1338	1339	1340	1341	1342	1343	1344	1345

1346	1363	1364	1365	1366	1367	1368	1369	1370	1371	1373
1374	1375	1376	1377	1378						

International

1701	1702	1703	1704	1705	1706	1707	1708	1709	1710	1711
1715	1716	1717	1718	1719	1720	1721	1722	1723	1729	1730
1731	1732	1733	1735							

Seasons

2001	2002	2003	2004	2005	2006	2007	2008	2009	2015	2016
2017	2018	2019	2020	2021	2022	2023				

Hobby and sports

2201	2202	2203	2204	2205	2206	2207	2209	2210	2211	2212
2213	2215	2216	2217	2218	2219					













18.2 Overview Embroidery motifs

Editing embroidery motifs

Let your creativity run free. A vast selection of embroidery motifs is at your disposal.







If one of the following pictograms is under the embroidery motif number, you can find additional information at

www.bernina.com/specialeffects.

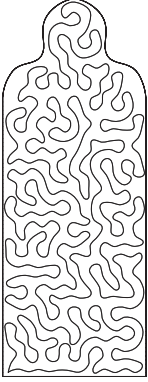
	Detached point		Punchwork Design (motif)
	Hole embroidery		Cord embroidery
	Fringe embroidery		Projects in the hoop
	Appliqué		Puffy fonts
	CutWork Design (motif)		Quilting
	PaintWork Design (motif)		Trapunto
	CrystalWork Design (motif)		



Projects



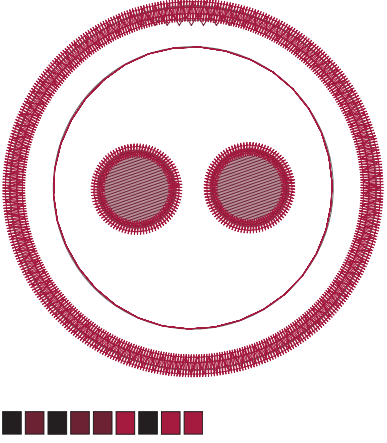



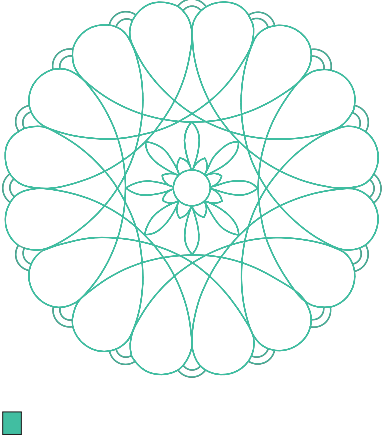



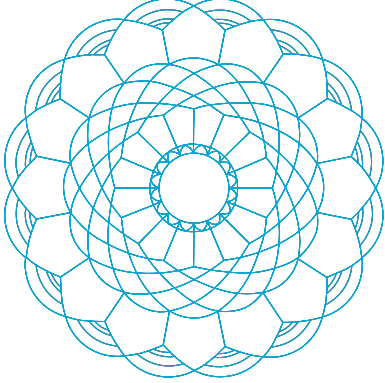

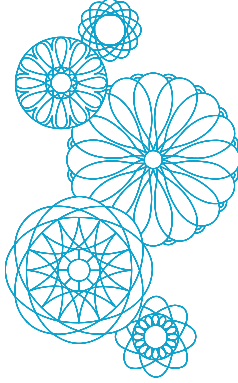

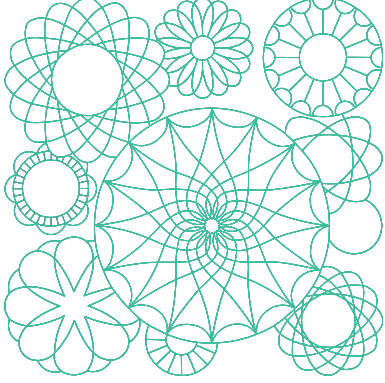
You can find the detailed stitch instructions at www.bernina.com/590designs

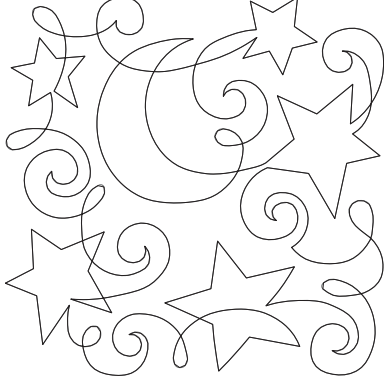
No.	Embroidery motif	No.	Embroidery motif
Width x Height	Colors	Width x Height	Colors
> mm		> mm	
> inch		> inch	
12593-04		12536-03	
			
95.3 x 174.0		112.9 x 226.1	
3.75 x 6.85		4.44 x 8.90	





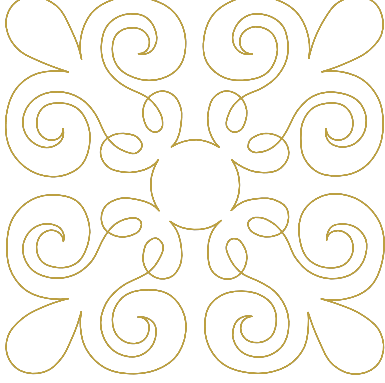





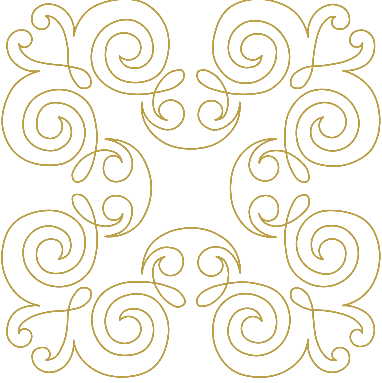

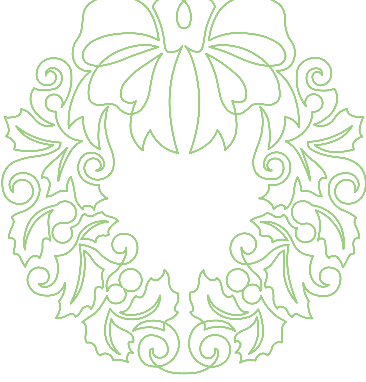

No.	Embroidery motif	No.	Embroidery motif
Width x Height	Colors	Width x Height	Colors
> mm		> mm	
> inch		> inch	
12619-04 0 57.8 x 57.4 2.27 x 2.25			

Quilt motifs

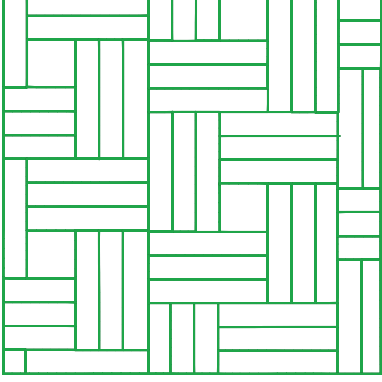

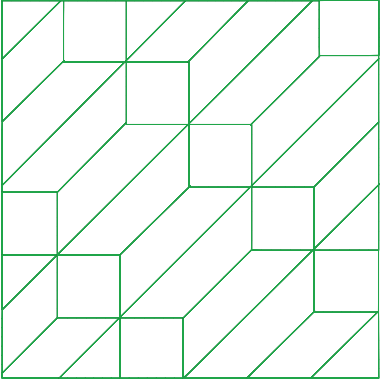

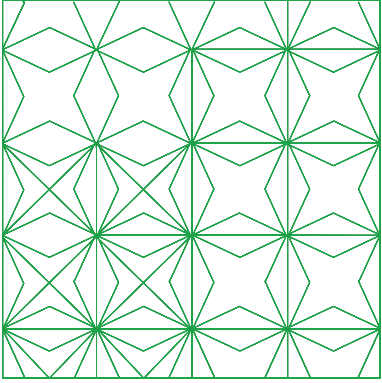





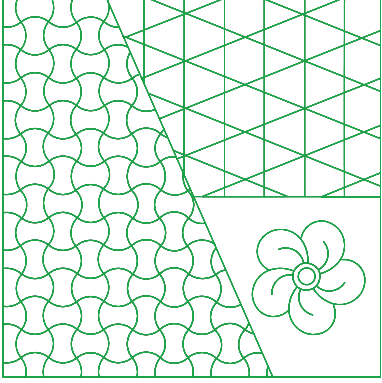

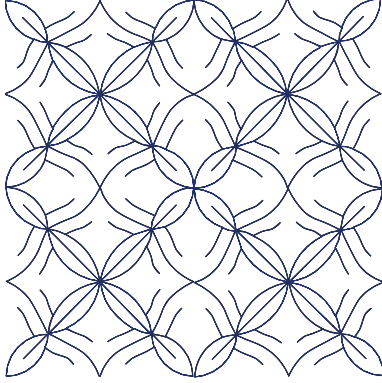
No.	Embroidery motif	No.	Embroidery motif
Width x Height	Colors	Width x Height	Colors
> mm		> mm	
> inch		> inch	
12499-06 101.7 x 101.6 4.00 x 4.00		12499-04 123.2 x 123.0 4.85 x 4.84	

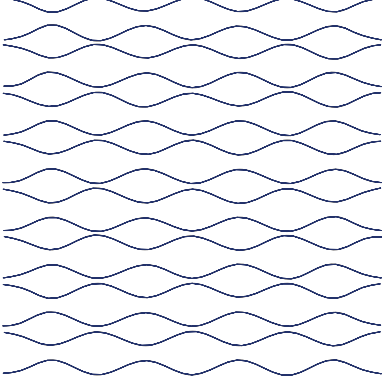

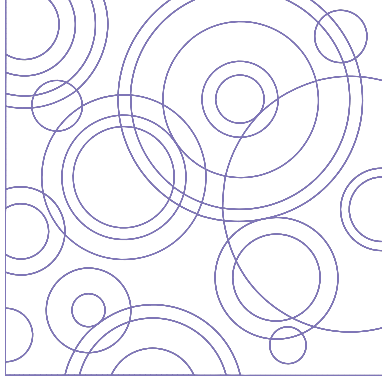

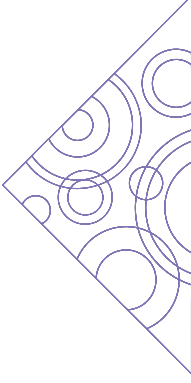

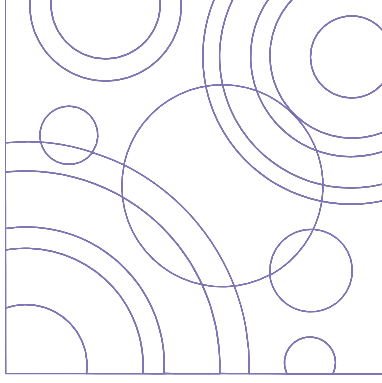



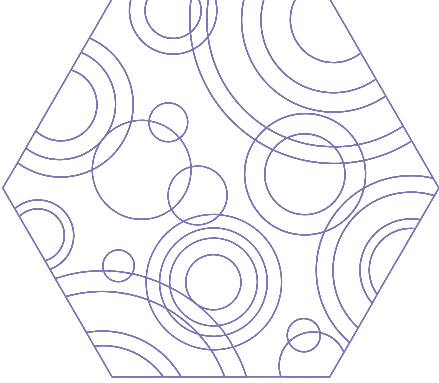

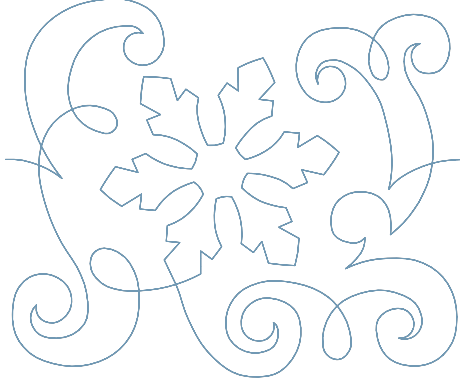

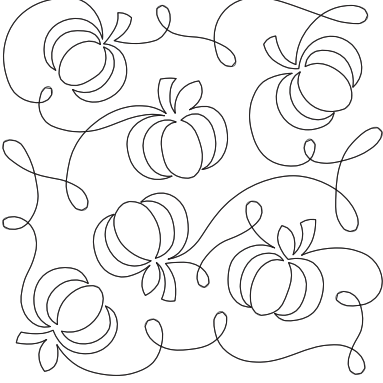
No. Width x Height > mm > inch	Embroidery motif Colors	No. Width x Height > mm > inch	Embroidery motif Colors
12499-05  123.3 x 123.3 4.85 x 4.85	 	12499-24  133.1 x 214.7 5.24 x 8.45	 
12499-23  123.3 x 123.3 4.85 x 4.85	 	12607-20  122.4 x 122.3 4.81 x 4.81	 
12607-21  61.2 x 122.7 2.40 x 4.83	 	12416-04  89.2 x 89.1 3.51 x 3.50	 

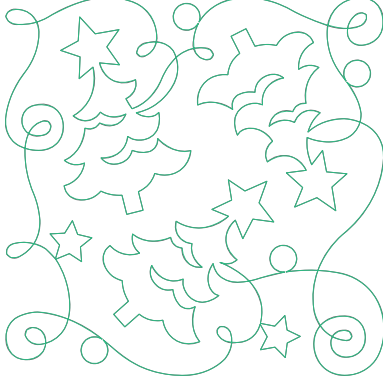





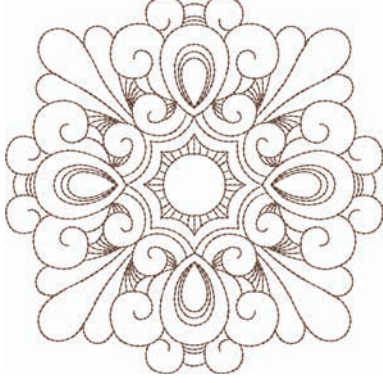



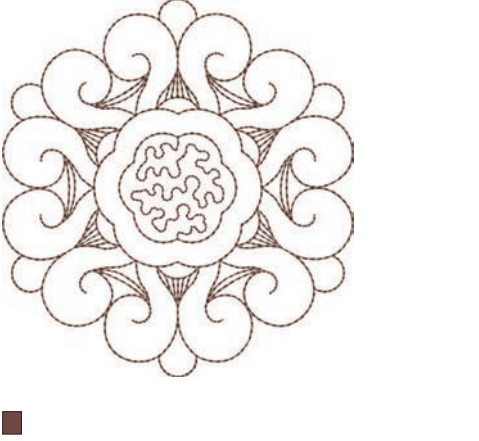





Overview stitch patterns

No. Width x Height > mm > inch	Embroidery motif Colors	No. Width x Height > mm > inch	Embroidery motif Colors
12416-03  124.0 x 124.0 4.88 x 4.88	 	12416-26  43.7 x 174.1 1.72 x 6.85	 
12416-48  160.0 x 167.0 6.30 x 6.60	 	NB346-48  76.2 x 76.3 3.00 x 3.00	 
NB347-48  76.2 x 76.3 3.00 x 3.00	 	NB334-48  127.0 x 127.0 5.00 x 5.00	 



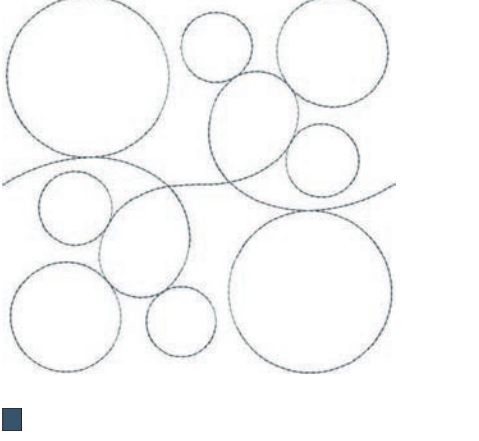

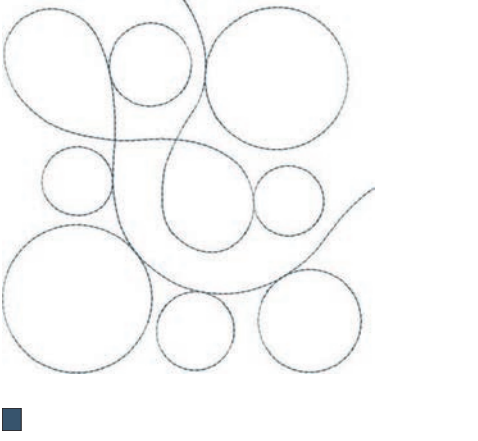





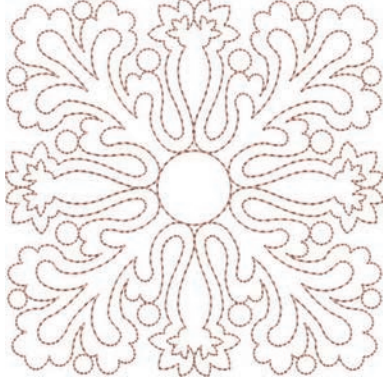

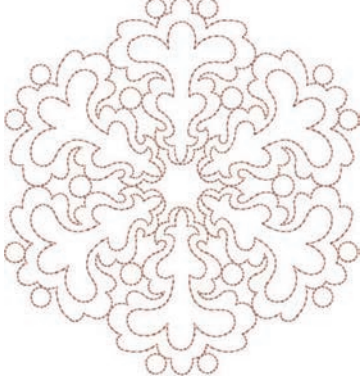









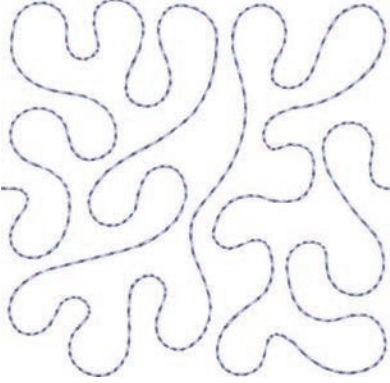

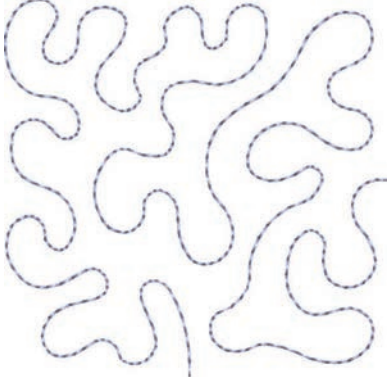



No. Width x Height > mm > inch	Embroidery motif Colors	No. Width x Height > mm > inch	Embroidery motif Colors
NB335-48  127.1 x 127.1 5.00 x 5.00	 	NZ498  88.9 x 88.9 3.50 x 3.50	 
NZ503  99.1 x 98.7 3.90 x 3.88	 	82013-29  121.2 x 121.2 4.76 x 4.76	 
82013-30  83.0 x 166.1 3.26 x 6.53	 	82013-31  57.6 x 57.6 2.26 x 2.26	 





No. Width x Height > mm > inch	Embroidery motif Colors	No. Width x Height > mm > inch	Embroidery motif Colors
82013-32  121.8 x 105.6 4.79 x 4.15	 	12416-24  88.9 x 73.1 3.50 x 2.87	 
 12607-16 122.8 x 122.3 4.83 x 4.81	 	12616-16  122.8 x 122.6 4.83 x 4.82	 
12380-22  110.6 x 60.9 4.35 x 2.39	 	12380-43  123.5 x 123.5 4.86 x 4.86	 

No. Width x Height > mm > inch	Embroidery motif Colors	No. Width x Height > mm > inch	Embroidery motif Colors
12380-30  89.2 x 96.3 3.51 x 3.79	 	12380-04  83.1 x 89.9 3.27 x 3.53	 
12380-08  89.2 x 89.1 3.51 x 3.50	 	12380-09  111.6 x 61.6 4.39 x 2.42	 
BD800  127.3 x 122.4 5.01 x 4.81	 	BD801  122.2 x 124.2 4.81 x 4.88	 



No. Width x Height > mm > inch	Embroidery motif Colors	No. Width x Height > mm > inch	Embroidery motif Colors
BD804  122.9 x 123.6 4.83 x 4.86	 	BD796  47.2 x 174.5 1.85 x 6.87	 
BD837  123.6 x 123.6 4.86 x 4.86	 	BD292  94.8 x 95.1 3.73 x 3.74	 
BD299  94.5 x 95.0 3.72 x 3.74	 	BD308  95.0 x 94.4 3.74 x 3.71	 













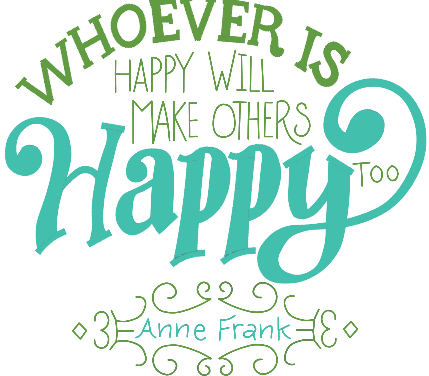

No. Width x Height > mm > inch	Embroidery motif Colors	No. Width x Height > mm > inch	Embroidery motif Colors
BD413  97.1 x 97.2 3.82 x 3.82	 	BD554  109.9 x 109.9 4.32 x 4.32	 
BD553  113.8 x 121.1 4.48 x 4.76	 	BD567  107.9 x 108.2 4.24 x 4.25	 
BD394  97.0 x 96.8 3.81 x 3.81	 	BD412  89.4 x 53.2 3.51 x 2.09	 

No. Width x Height > mm > inch	Embroidery motif Colors	No. Width x Height > mm > inch	Embroidery motif Colors
BD501  63.5 x 61.1 2.50 x 2.40	 	BD502  61.5 x 60.7 2.42 x 2.38	 
BD513  63.5 x 63.4 2.50 x 2.49	 	BD514  63.5 x 62.9 2.50 x 2.47	 
BD562  63.9 x 126.0 2.51 x 4.96	 	BD568  109.5 x 160.3 4.31 x 6.31	 













No.	Embroidery motif	No.	Embroidery motif
Width x Height	Colors	Width x Height	Colors
> mm		> mm	
> inch		> inch	
BD563		BD569_48	
			
89.7 x 89.6		120.6 x 120.6	
3.53 x 3.52		4.74 x 4.74	





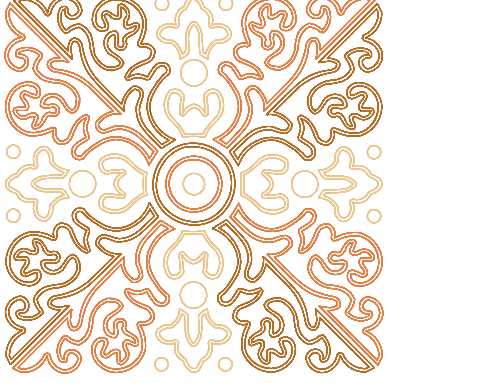









Ornaments









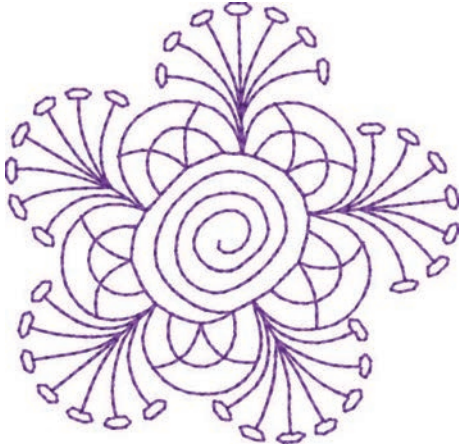

No.	Embroidery motif	No.	Embroidery motif
Width x Height	Colors	Width x Height	Colors
> in mm		> in mm	
> in inch		> in inch	
NB843-48		NB826-48	
87.6 x 121.1		134.9 x 132.9	
3.44 x 4.76		5.31 x 5.23	

No. Width x Height > in mm > in inch	Embroidery motif Colors	No. Width x Height > in mm > in inch	Embroidery motif Colors
12633-06 119.8 x 119.9 4.71 x 4.72	 	12473-04 93.6 x 184.2 3.68 x 7.25	 
BE7904-03 140.0 x 130.4 5.51 x 5.13	 	12473-06 133.4 x 119.9 5.25 x 4.72	 
80090-06  83.6 x 37.0 3.29 x 1.45	 	80090-07  128.1 x 36.5 5.04 x 1.43	 



No. Width x Height > in mm > in inch	Embroidery motif Colors	No. Width x Height > in mm > in inch	Embroidery motif Colors
19999-002 124.9 x 136.4 4.91 x 5.37		NB934-48 132.4 x 164.8 5.21 x 6.48	
NB935-48 104.1 x 168.9 4.09 x 6.64		21021-05 118.7 x 155.7 4.67 x 6.12	
21021-04 123.1 x 150.2 4.84 x 5.91		21021-06 116.0 x 109.5 4.56 x 4.31	

No. Width x Height > in mm > in inch	Embroidery motif Colors	No. Width x Height > in mm > in inch	Embroidery motif Colors
12490-03 118.1 x 113.4 4.64 x 4.46	 	12490-04 146.4 x 122.4 5.76 x 4.81	 
12490-05 125.8 x 104.5 4.95 x 4.11	 	FP887 186.7 x 134.8 7.35 x 5.30	 
12528-12 123.8 x 123.8 4.87 x 4.87	 	12528-03 76.6 x 130.5 3.01 x 5.13	 







No. Width x Height > in mm > in inch	Embroidery motif Colors	No. Width x Height > in mm > in inch	Embroidery motif Colors
OC07207 105.8 x 138.6 4.16 x 5.45	 	82007-11  111.7 x 94.2 4.39 x 3.70	 
82007-44 114.0 x 114.8 4.48 x 4.51	 	82006-30  99.9 x 174.6 3.93 x 6.87	 
NB251 71.6 x 103.3 2.81 x 4.06	 	BE790405 125.9 x 185.4 4.95 x 7.29	 

No. Width x Height > in mm > in inch	Embroidery motif Colors	No. Width x Height > in mm > in inch	Embroidery motif Colors
FB126 86.9 x 102.2 3.42 x 4.02	 	BE790502 59.9 x 58.2 2.35 x 2.29	 
21003-26  123.0 x 124.1 4.84 x 4.88	 	NB403 78.1 x 78.3 3.07 x 3.08	 
NB373 121.4 x 176.8 4.77 x 6.96	 	NB442 55.6 x 58.4 2.18 x 2.29	 

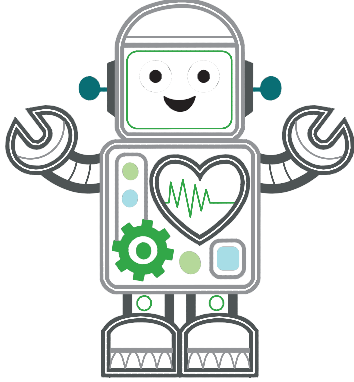





No. Width x Height > in mm > in inch	Embroidery motif Colors	No. Width x Height > in mm > in inch	Embroidery motif Colors
NB481 123.4 x 67.6 4.85 x 2.66	 	NB749 126.5 x 262.8 4.98 x 10.34	 
NA959  75.6 x 103.7 2.97 x 4.08	 	FB106 128.1 x 92.6 5.04 x 3.64	 
NB002 59.3 x 35.1 2.33 x 1.38	 	FQ870 122.1 x 105.1 4.80 x 4.13	 

No.	Embroidery motif	No.	Embroidery motif
Width x Height	Colors	Width x Height	Colors
> in mm		> in mm	
> in inch		> in inch	
WS655			
116.5 x 222.3			
4.58 x 8.75			













Children









No.	Embroidery motif	No.	Embroidery motif
Width x Height	Colors	Width x Height	Colors
> mm		> mm	
> inch		> inch	
12590-03		CK867	
			
135.5 x 146.9		122.2 x 132.8	
5.33 x 5.78		4.81 x 5.22	

No. Width x Height > mm > inch	Embroidery motif Colors	No. Width x Height > mm > inch	Embroidery motif Colors
CM031-48 85.7 x 63.4 3.37 x 2.49	 	12401-17 98.8 x 55.1 3.88 x 2.16	 
CK859  118.8 x 141.8 4.67 x 5.58	 Tickle My Tummy 	CK520 75.6 x 60.3 2.97 x 2.37	 
CK510 76.2 x 59.9 3.00 x 2.35	 	CK522 70.8 x 53.1 2.78 x 2.09	 











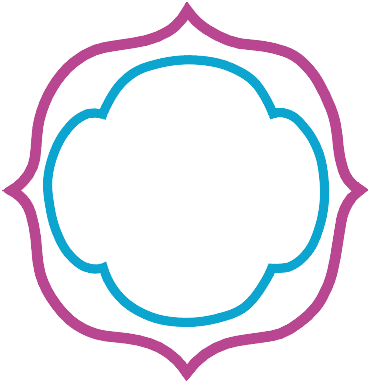

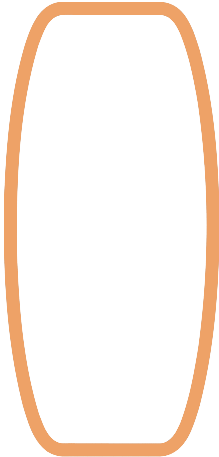
No. Width x Height > mm > inch	Embroidery motif Colors	No. Width x Height > mm > inch	Embroidery motif Colors
CK863  127.1 x 124.6 5.00 x 4.90	 <p>Wish Upon My Star Light</p> 	NB198-48 94.2 x 72.4 3.70 x 2.85	 
BE790307  141.5 x 126.9 5.57 x 4.99	 	BE790311  114.1 x 152.5 4.49 x 6.00	 
BE790305  118.3 x 145.5 4.65 x 5.72	 	BE790306  132.1 x 151.4 5.20 x 5.96	 

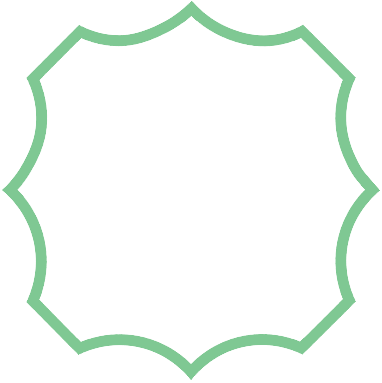

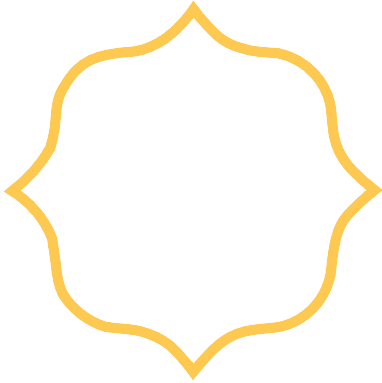

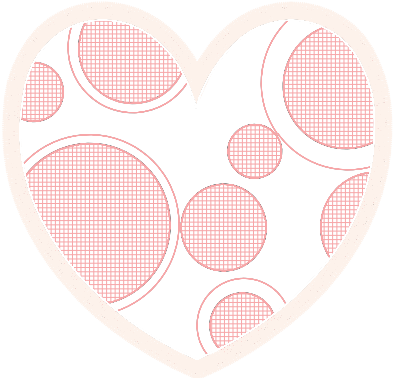











No. Width x Height > mm > inch	Embroidery motif Colors	No. Width x Height > mm > inch	Embroidery motif Colors
BE790309  87.5 x 149.8 3.44 x 5.89	 	BE790310  137.8 x 136.0 5.42 x 5.35	 
BE790312  122.0 x 133.1 4.80 x 5.24	 	BE790313  98.9 x 102.3 3.89 x 4.02	 
CK511 76.2 x 64.6 3.00 x 2.54	 	CM193-48  106.7 x 127.4 4.20 x 5.01	 



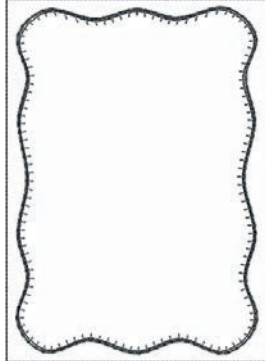



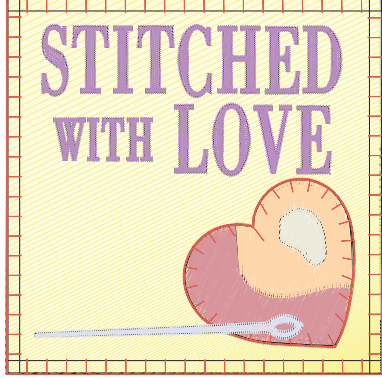



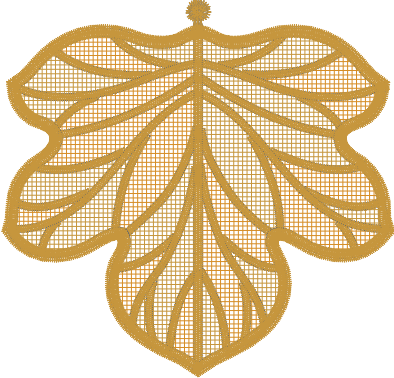

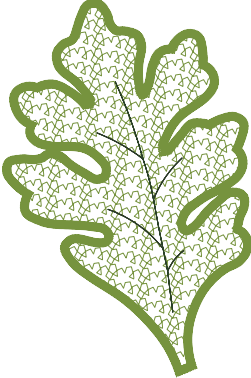

No. Width x Height > mm > inch	Embroidery motif Colors	No. Width x Height > mm > inch	Embroidery motif Colors
CK667  99.8 x 82.3 3.92 x 3.24	 	CK738 89.1 x 85.7 3.50 x 3.37	 
CK970 84.4 x 81.6 3.33 x 3.21	 	CM147 55.0 x 99.6 2.16 x 3.92	 
CM22648 63 x 63 2.5 x 2.5	 	CM348 119.0 x 167.1 4.68 x 6.57	 



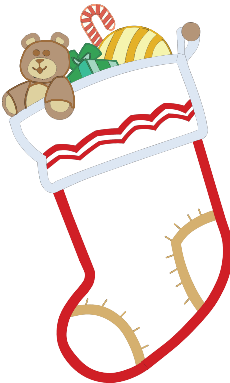
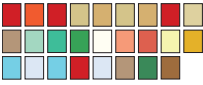







No. Width x Height > mm > inch	Embroidery motif Colors	No. Width x Height > mm > inch	Embroidery motif Colors
CM362  120.6 x 113.0 4.74 x 4.44	 	CM376  100.3 x 97.5 3.94 x 3.84	 
NB193 113.3 x 96.2 4.46 x 3.78	 		

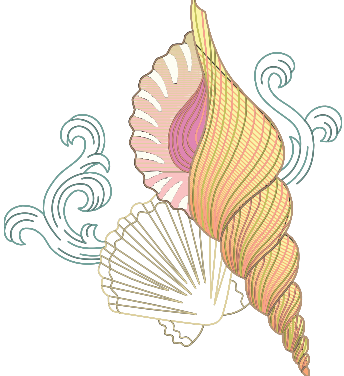

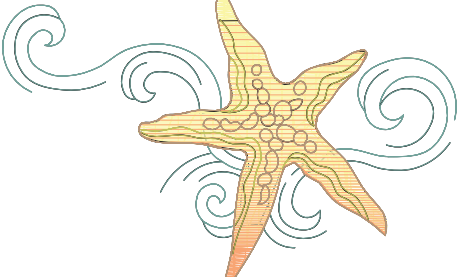

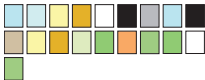





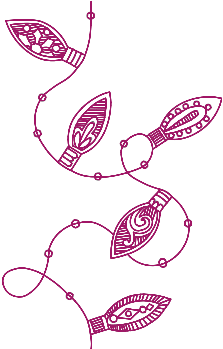

Frames and borders





No. Width x Height > mm > inch	Embroidery motif Colors	No. Width x Height > mm > inch	Embroidery motif Colors
80090-26  124.4 x 128.8 4.89 x 5.07	 	12630-07  97.0 x 205.0 3.8 x 8.1	 
12611-27  136.9 x 137.3 5.38 x 5.40	 	12611-28  140.0 x 140.0 5.51 x 5.51	 
12649-05  91.2 x 88.6 3.59 x 3.48	 	12606-26  138.8 x 138.8 5.46 x 5.46	 





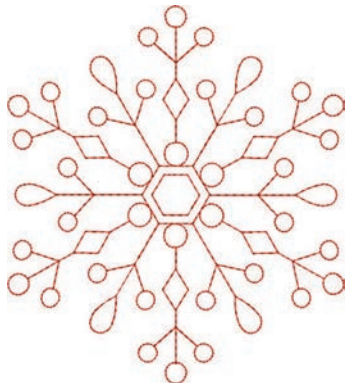

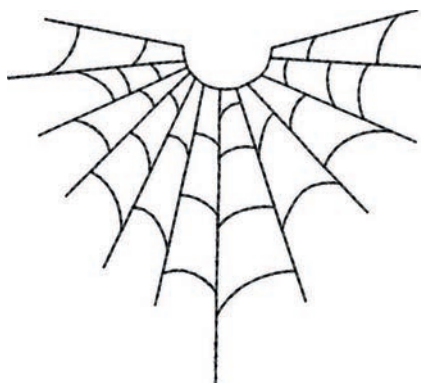





No. Width x Height > mm > inch	Embroidery motif Colors	No. Width x Height > mm > inch	Embroidery motif Colors
12606-33  43.0 x 70.0 1.69 x 2.75	 	12606-37  45.6 x 77.8 1.79 x 3.06	 
32078-02  123.4 x 172.9 4.85 x 6.80	 	32078-03  123.4 x 172.9 4.85 x 6.80	 
32078-04  123.4 x 172.9 4.85 x 6.80	 	NZ195 76.8 x 76.8 3.02 x 3.02	 



No. Width x Height > mm > inch	Embroidery motif Colors	No. Width x Height > mm > inch	Embroidery motif Colors
12597-16 88.4 x 85.0 3.48 x 3.34	 	80009-17 85.7 x 129.8 3.37 x 5.11	 
HE255  133.2 x 127.1 5.24 x 5.00	 	HE252  88.1 x 145.0 3.46 x 5.70	 
HG746-48  111.6 x 138.2 4.39 x 5.44	 	RC514 74.3 x 98.8 2.92 x 3.88	 

No. Width x Height > mm > inch	Embroidery motif Colors	No. Width x Height > mm > inch	Embroidery motif Colors
HG747-48  124.0 x 147.5 4.88 x 5.80	 	NB754-48 114.3 x 128.1 4.50 x 5.04	 
NB759-48 98.7 x 61.7 3.88 x 2.42	 	HD976 101.1 x 108.3 3.98 x 4.26	 
HG806-48 27.7 x 170.4 1.07 x 6.70	 	12415-32 79.6 x 191.2 3.13 x 7.52	 



No. Width x Height > mm > inch	Embroidery motif Colors	No. Width x Height > mm > inch	Embroidery motif Colors
12415-29 108.4 x 172.4 4.26 x 6.78	 	12655-14 164 x 110 6.45 x 4.33	 
12433-05  83.4 x 124.4 3.28 x 4.89	 	12417-04 84.3 x 97.1 3.31 x 3.82	 
BE790303 69.5 x 70.1 2.73 x 2.75	 	BE790301 127.2 x 89.0 5.00 x 3.50	 







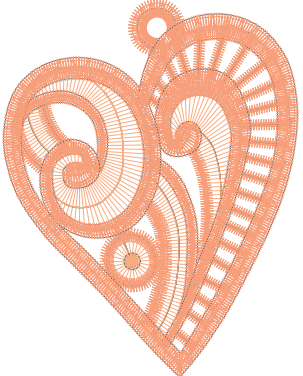
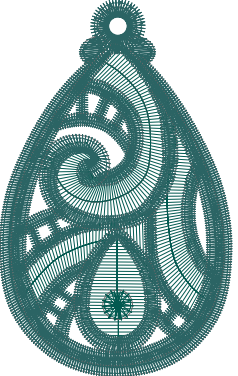



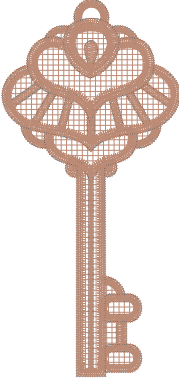



No. Width x Height > mm > inch	Embroidery motif Colors	No. Width x Height > mm > inch	Embroidery motif Colors
GNNF80834 95.2 x 78.8 3.74 x 3.10	 <p>Color palette: Green, Pink, Blue, Grey</p>	HE962 120.5 x 135.2 4.74 x 5.32	 <p>Color palette: Red</p>
12421-11 39.9 x 43.6 1.57 x 1.71	 <p>Color palette: Yellow, Black, White</p>	12421-37 67.4 x 61.0 2.65 x 2.40	 <p>Color palette: Black</p>
12421-03 45.8 x 48.3 1.80 x 1.90	 <p>Color palette: Black, White, Grey</p>	CM287 90.4 x 117.2 3.55 x 4.61	 <p>Color palette: Green, Red, Pink, Yellow, White, Black, Grey</p>

No. Width x Height > mm > inch	Embroidery motif Colors	No. Width x Height > mm > inch	Embroidery motif Colors
CM426 45.8 x 96.0 1.80 x 3.77	 	FQ749 77.6 x 94.8 3.05 x 3.73	 
HE919 89.1 x 69.2 3.50 x 2.72	 	HG053 122.1 x 121.8 4.80 x 4.79	 
HG319 88.6 x 151.5 3.48 x 5.96	 	HG460 91.8 x 98.1 3.61 x 3.86	 













No.	Embroidery motif	No.	Embroidery motif
Width x Height	Colors	Width x Height	Colors
> mm		> mm	
> inch		> inch	
NB317			
87.4 x 86.9			
3.44 x 3.42			













Borders and Lace

No.	Embroidery motif	No.	Embroidery motif
Width x Height	Colors	Width x Height	Colors
> mm		> mm	
> inch		> inch	
12659-01		12659-06	
			
45.2 x 57.8		36.7 x 59.5	
1.77 x 2.27		1.44 x 2.34	











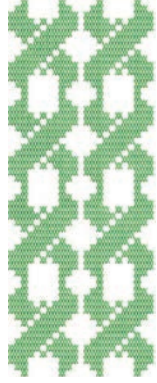

No. Width x Height > mm > inch	Embroidery motif Colors	No. Width x Height > mm > inch	Embroidery motif Colors
21021-25  33.8 x 71.5 1.33 x 2.81	 	OC00303  100.6 x 110.6 3.96 x 4.35	 
HG341 63.8 x 63.7 2.51 x 2.50	 	NX957 97.9 x 88.1 3.85 x 3.46	 
NX696 91.2 x 90.7 3.59 x 3.57	 	FB461  121.7 x 121.6 4.79 x 4.78	 

Overview stitch patterns

No. Width x Height > mm > inch	Embroidery motif Colors	No. Width x Height > mm > inch	Embroidery motif Colors
12633-20 34.3 x 170.1 1.35 x 6.69	 	12508-08 40.0 x 150.9 1.57 x 5.94	 
12508-17 42.1 x 152.5 1.65 x 6.00	 	OC33411 24.2 x 177.1 0.95 x 6.97	 
OC33416  36.4 x 127.8 1.43 x 5.03	 	12485-12 41.3 x 139.0 1.62 x 5.47	 

No. Width x Height > mm > inch	Embroidery motif Colors	No. Width x Height > mm > inch	Embroidery motif Colors
12485-31 45.6 x 225.2 1.79 x 8.86	 	21013-29 40.2 x 152.0 1.58 x 5.98	 
BE110415 43.7 x 172.4 1.72 x 6.78	 	FA981 35.1 x 142.3 1.38 x 5.60	 
21002-21 21.6 x 150.9 0.85 x 5.94	 	21009-29 31.9 x 152.6 1.25 x 6.00	 





Overview stitch patterns





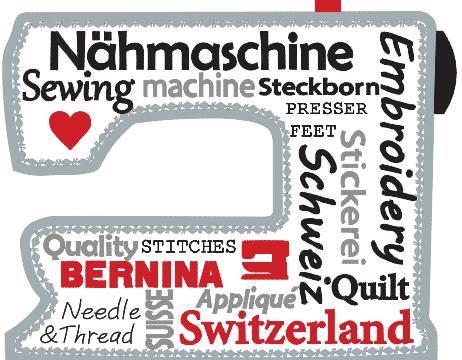





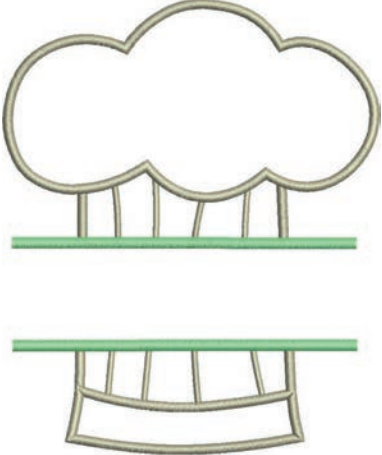

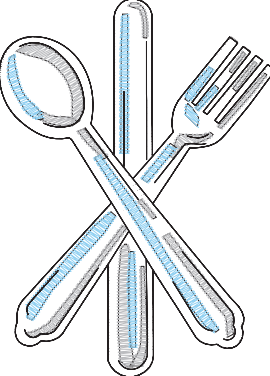
No. Width x Height > mm > inch	Embroidery motif Colors	No. Width x Height > mm > inch	Embroidery motif Colors
82005-40 26.0 x 239.4 1.02 x 9.42	 	BE790702 73.0 x 190.5 2.87 x 7.50	 
NA914 18.8 x 120.3 4.73 x 0.74	 	NB520 26.3 x 175.9 1.03 x 6.92	 
HG177 50.0 x 158.6 1.96 x 6.24	 	CM473 31.8 x 209.6 1.25 x 8.25	 

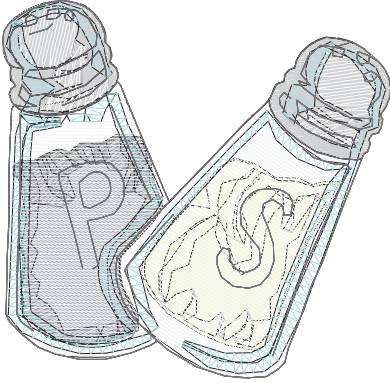









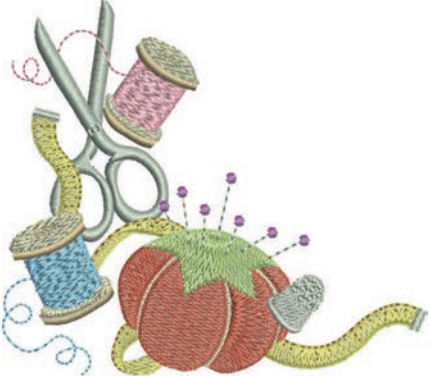

No.	Embroidery motif	No.	Embroidery motif
Width x Height	Colors	Width x Height	Colors
> mm		> mm	
> inch		> inch	
FB436			
29.2 x 132.8			
1.15 x 5.22			

Sports and hobby



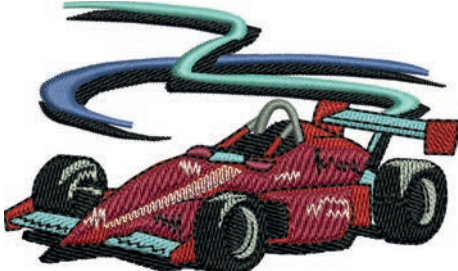

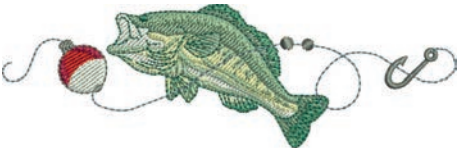









No.	Embroidery motif	No.	Embroidery motif
Width x Height	Colors	Width x Height	Colors
> mm		> mm	
> inch		> inch	
82014-28		12611-08	
 141.5 x 117.1		 80.0 x 119.7	
5.57 x 4.61		3.14 x 4.71	





No. Width x Height > mm > inch	Embroidery motif Colors	No. Width x Height > mm > inch	Embroidery motif Colors
12611-18  130.2 x 157.6 5.12 x 6.20	 	NX737 72.1 x 98.7 2.83 x 3.88	 
NX741 80.0 x 78.0 3.14 x 3.07	 	12383-18 90.7 x 171.2 3.57 x 6.74	 
12472-01  137.7 x 141.7 5.42 x 5.57	 	SP980 63.2 x 63.5 2.48 x 2.50	 

No. Width x Height > mm > inch	Embroidery motif Colors	No. Width x Height > mm > inch	Embroidery motif Colors
BE790606 100.2 x 86.0 3.94 x 3.38		BE790608 80.3 x 80.1 3.16 x 3.15	
BE790603 80.5 x 74.8 3.16 x 2.94		BE790602 80.3 x 75.6 3.16 x 2.97	
SP989 101.6 x 82.5 4.00 x 3.24		SR067 87.5 x 96.6 3.44 x 3.81	





No. Width x Height > mm > inch	Embroidery motif Colors	No. Width x Height > mm > inch	Embroidery motif Colors
FB148 101.1 x 89.5 3.98 x 3.52	 	SR589 95.2 x 66.5 3.75 x 2.61	 
LT870 97.5 x 57.0 3.83 x 2.24	 	RC244 88.4 x 53.4 3.48 x 2.10	 
SR551 120.3 x 38.0 4.73 x 1.49	 		

Animals





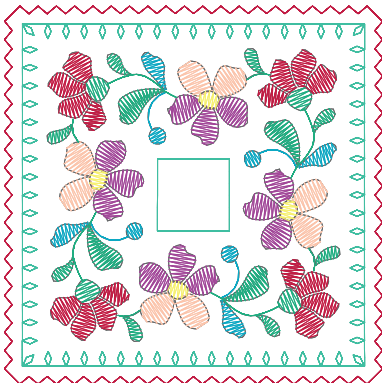







No. Width x Height > mm > inch	Embroidery motif Colors	No. Width x Height > mm > inch	Embroidery motif Colors
WP415-48 132.4 x 148.4 5.21 x 5.84	 	CM216-48  47.0 x 67.0 1.85 x 2.63	 
CM213-48  58.3 x 101.9 2.29 x 4.01	 	WP421-48 95.8 x 137.5 3.77 x 5.41	 
NA248 77.5 x 73.3 3.05 x 2.88	 	HD977 97.7 x 98.6 3.84 x 3.88	 

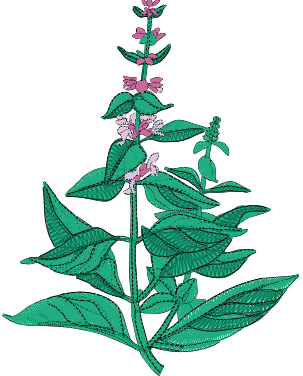











No.	Embroidery motif	No.	Embroidery motif
Width x Height	Colors	Width x Height	Colors
> mm		> mm	
> inch		> inch	
LJ598 106.5 x 81.5 4.19 x 3.20	 	CM220  71.5 x 71.8 2.81 x 2.82	 







Flowers





No.	Embroidery motif	No.	Embroidery motif
Width x Height	Colors	Width x Height	Colors
> mm		> mm	
> inch		> inch	
21027-01 123.0 x 122.2 4.84 x 4.81	 	21027-14 120.8 x 120.8 4.75 x 4.75	 

No. Width x Height > mm > inch	Embroidery motif Colors	No. Width x Height > mm > inch	Embroidery motif Colors
21027-16 57.4 x 151.8 2.25 x 5.97	 	21027-17 57.3 x 151.4 2.25 x 5.96	 
21017-01 104.5 x 157.5 4.11 x 6.20	 	FI135 88.5 x 87.1 3.48 x 3.42	 
FI136 84.7 x 89.2 3.33 x 3.51	 	FI138 85.0 x 75.5 3.34 x 2.97	 







No. Width x Height > mm > inch	Embroidery motif Colors	No. Width x Height > mm > inch	Embroidery motif Colors
FI142 79.0 x 85.8 3.11 x 3.37	 	FI230 78.1 x 72.4 3.07 x 2.85	 
FI171 69.5 x 88.9 2.73 x 3.50	 	82006-07 123.7 x 165.6 4.87 x 6.51	 
21006-02 114.5 x 135.5 4.50 x 5.33	 	80001-23 85.0 x 101.6 3.34 x 4.00	 

No. Width x Height > mm > inch	Embroidery motif Colors	No. Width x Height > mm > inch	Embroidery motif Colors
12457-06 106.3 x 172.3 4.18 x 6.78	 	12457-13 113.1 x 130.3 4.45 x 5.12	 
21009-21 64.9 x 107.7 2.55 x 4.24	 	BE790408 58.3 x 89.7 2.29 x 3.53	 
21002-02 109.7 x 160.0 4.31 x 6.29	 	21012-04 123.1 x 123.9 4.84 x 4.87	 

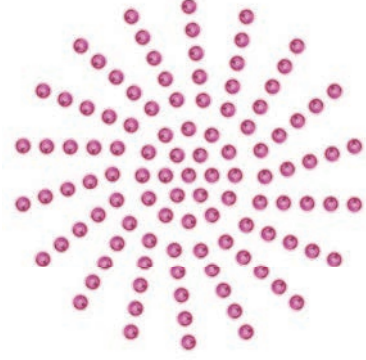













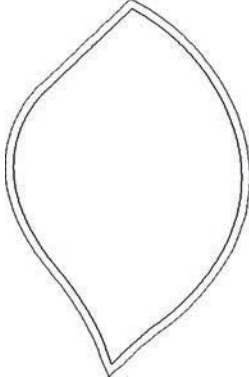

No. Width x Height > mm > inch	Embroidery motif Colors	No. Width x Height > mm > inch	Embroidery motif Colors
FB492 86.8 x 293.2 3.41 x 11.54		FP246 65.6 x 61.8 2.58 x 2.43	
FP814 88.0 x 84.4 3.46 x 3.32		FQ562 90.3 x 156.3 3.55 x 6.15	
FQ722 80.0 x 90.6 3.14 x 3.56		FQ733 66.5 x 66.5 2.61 x 2.61	

No.	Embroidery motif	No.	Embroidery motif
Width x Height	Colors	Width x Height	Colors
> mm		> mm	
> inch		> inch	
FQ801		NB209	
46.0 x 112.5		90.0 x 89.9	
1.81 x 4.42		3.54 x 3.53	













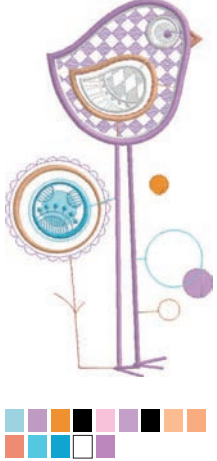

Designs with special effects

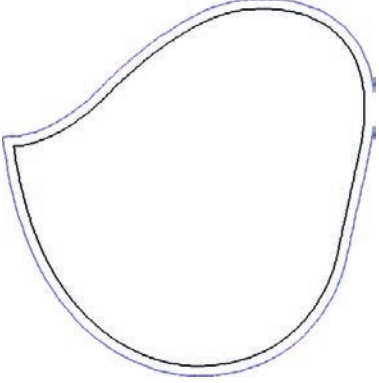

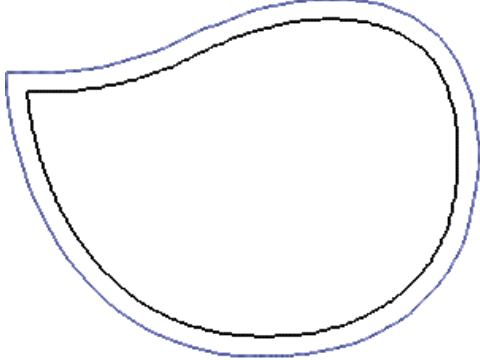

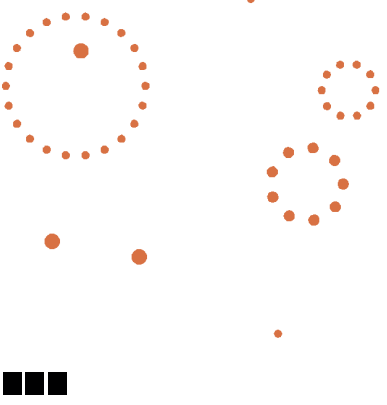

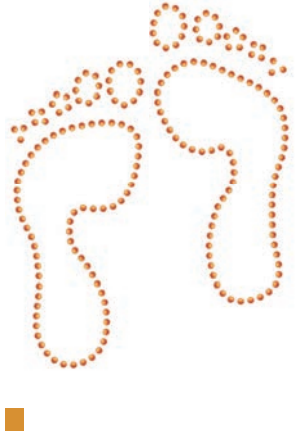

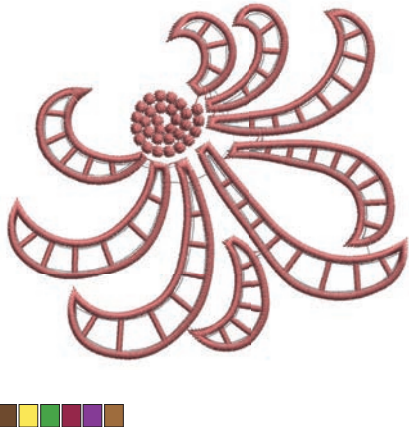

No.	Embroidery motif	No.	Embroidery motif
Width x Height	Colors	Width x Height	Colors
> mm		> mm	
> inch		> inch	
DW11		21026-08_DW	
			
70 x 71		86.4 x 174.0	
2.76 x 2.80		3.40 x 6.85	

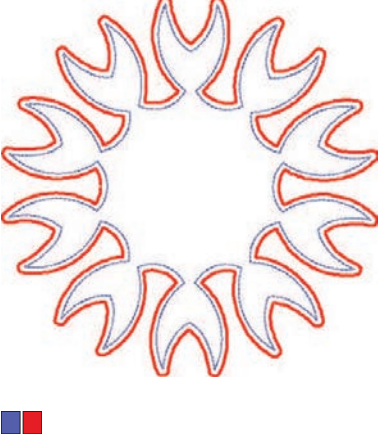

Overview stitch patterns

No. Width x Height > mm > inch	Embroidery motif Colors	No. Width x Height > mm > inch	Embroidery motif Colors
21026-02_DW  68.6 x 193.8 2.70 x 7.62	 	21026_-02  60.8 x 93.8 2.39 x 3.69	
21026-02_CR  103 x 127 4.05 x 0.47	 	12448-09_PW  121 x 161 4.76 x 6.34	 
21026-05_DW  118.0 x 201.9 4.64 x 7.94	 	12448-11_CR  84 x 123 3.31 x 4.84	 

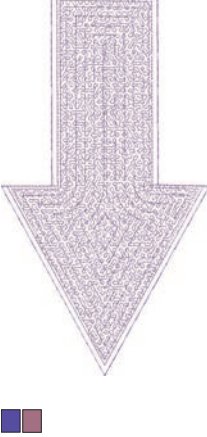

No. Width x Height > mm > inch	Embroidery motif Colors	No. Width x Height > mm > inch	Embroidery motif Colors
12448-08_PW  119.1 x 177.4 4.68 x 6.98	 	21022-13_DW   105.6 x 192.8 4.15 x 7.59	
21022_-13  75.4 x 76.4 2.96 x 3.00		21022-13_CWA_B  47.7 x 36.2 1.86 x 1.42	
21022-13_CR  95 x 86 3.74 x 3.39	 	DW07  114 x 152 4.49 x 5.98	 

No. Width x Height > mm > inch	Embroidery motif Colors	No. Width x Height > mm > inch	Embroidery motif Colors
DW05  105 x 94 4.13 x 3.70		DW10  119 x 119 4.69 x 4.69	
DW08  100 x 206 3.94 x 8.11		BE700121  128 x 128 5.0 x 5.1	
BE700122  119.4 x 37.0 4.70 x 1.45		BE700123  112.7 x 205.8 4.43 x 8.10	

No. Width x Height > mm > inch	Embroidery motif Colors	No. Width x Height > mm > inch	Embroidery motif Colors
BE700124  141.0 x 134.4 5.55 x 5.29	 		

Index

A

Adjusting the hoop.....	54
Adjusting the presser foot pressure.....	37
Adjusting the presser position via the knee lifter of the Free Hand System.....	35
Adjusting the upper thread tension.....	48
Alphabets.....	107
Altering the embroidery motif size disproportionately.....	152
Altering the embroidery motif size proportionally.....	152
Altering the stitch density.....	154
Attaching the hoop.....	144
Attaching the knee lifter.....	29

B

BERNINA Dual Feed.....	70
Buttonholes.....	110

C

Calibrating Buttonhole foot with slide No. 3A.....	64
Calling up Help.....	69
Calling up the Creative Consultant.....	68
Calling up the Embroidery Consultant.....	68
Calling up the tutorial.....	68
Changing the color.....	165
Changing the needle.....	37
Changing the presser foot.....	36
Changing the stitch plate.....	39
Checking the firmware version.....	61
Cleaning the feed dog.....	176
Cleaning the hook.....	176
Cleaning the thread catcher.....	66
Combi Mode.....	161
Combination mode.....	76
Combining embroidery motifs.....	161
Connecting the embroidery module.....	136
Connecting the foot control.....	29
Cord.....	114

D

Decorative stitches.....	102
Dispose of the machine.....	186

E

Embroidery file format.....	133
Embroidery test.....	133
Entering dealer data.....	61
Environmental Protection.....	11
Error messages.....	181
Explanation of symbols.....	12

F

Fitting the BSR presser foot.....	126
Fitting the embroidery needle.....	139
Fitting the stitch plate.....	141
Free point positioning.....	161

I

Introduction.....	13
-------------------	----

L

Lubricating the hook.....	177
---------------------------	-----

M

Maintenance and cleaning.....	176
Moving the hoop to the back.....	146
Moving the module for the sewing mode.....	146

N

Needle stop up/down (permanent).....	39
Needle, Thread, Fabric.....	25
Needles, Threads.....	27

O

Overview Embroidery module.....	130
Overview of embroidery motifs.....	193
Overview of the stitch patterns.....	187

P

Pintucks.....	105
Placing the spool disc.....	32
Positioning of grid points.....	160

Q

Quilting.....	123
---------------	-----



in partnership with

Mettler

BERNINA International AG | CH-8266 Steckborn Switzerland | www.bernina.com | © Copyright by BERNINA International AG

1026725_10A.04
2019-09 EN

made to create **BERNINA**