



## BERNINA 765 SPECIAL EDITION

# LOOKING FOR A NEW SEWING PROJECT?

You can find what you want in "inspiration", our sewing magazine. Thanks to great sewing patterns and detailed sewing instructions, every project succeeds right away.

Inspiration magazine  
is available in German, English,  
French and Dutch



\* Not available in all countries.



## Edition notice

### Graphics

[www.sculpt.ch](http://www.sculpt.ch)

### Text, Setting and Layout

BERNINA International AG

### Photos

Patrice Heilmann, Winterthur

### Part number

1017815.10A.04

2018-11 EN

### Copyright

2018 BERNINA International AG

**All rights reserved:** For technical reasons and for the purpose of product improvements, changes concerning the features of the machine can be made at any time and without advance notice. The supplied accessory can vary depending on the country of delivery.



# Table of Contents

<b>IMPORTANT SAFETY INSTRUCTIONS.....</b>	<b>14</b>
<b>Important information .....</b>	<b>16</b>
<b>1 My BERNINA.....</b>	<b>17</b>
1.1 Introduction .....	17
1.2 BERNINA Quality control .....	17
1.3 Welcome to the world of BERNINA .....	17
1.4 Explanation of symbols.....	18
1.5 Overview Machine .....	19
Overview front controls .....	19
Overview front .....	20
Overview sideways .....	21
Overview back.....	22
1.6 Supplied accessories.....	23
Overview accessories machine .....	23
Use of the power cable (only USA/Canada).....	25
Overview presser feet .....	25
Accessory box.....	26
1.7 Overview User Interface .....	27
Overview functions/visual information .....	27
Overview System settings .....	27
Overview selection menu sewing.....	28
Overview Icons .....	28
1.8 Needle, Thread, Fabric.....	29
Overview Needles.....	29
Example for needle description .....	31
Thread selection .....	31
Needle/thread combination .....	32
<b>2 Sewing preparation.....</b>	<b>33</b>
2.1 Accessory box .....	33
Accessory box free standing .....	33
Storing accessory.....	33
2.2 Connection and Switching on .....	34
Connecting the foot control .....	34
Connecting the machine .....	34
Attaching the knee lifter of the Free Hand System .....	35
Fixing the touchscreen pen .....	35
Switching the machine on .....	35
2.3 Foot control .....	36
Regulating the speed via the foot control .....	36
Raising/Lowering the needle .....	36
Programming the foot control individually .....	36
2.4 Spool pin .....	36
Swiveling spool pin.....	36
Horizontal spool pin .....	37
2.5 Free arm .....	38



2.6	Feed dog.....	38
	Adjusting the feed dog.....	38
2.7	Slide-on table.....	39
	Using the slide-on table.....	39
2.8	Presser foot.....	40
	Adjusting the presser foot position via the knee lifter of the Free Hand System.....	40
	Adjusting the presser foot position via the button «Presser foot up/down».....	40
	Changing the presser foot.....	40
	Having the presser foot displayed in the User Interface.....	40
	Adjusting the presser foot pressure.....	41
2.9	Instruction for adjusting the feed dog.....	41
2.10	Needle and stitch plate.....	41
	Changing the needle.....	41
	Selecting the needle in the User Interface.....	42
	Selecting the needle type and the needle size.....	42
	Adjusting the needle position up/down.....	43
	Adjusting the needle position left/right.....	43
	Needle stop up/down (permanent).....	43
	Changing the stitch plate.....	43
	Selecting the stitch plate in the User Interface.....	44
2.11	Threading.....	44
	Threading the upper thread.....	44
	Threading the double needle.....	47
	Threading the triple needle.....	47
	Winding the bobbin thread.....	48
	Threading the bobbin thread.....	49
	Indicating fill level of bobbin thread.....	51
<b>3</b>	<b>Setup Program.....</b>	<b>52</b>
3.1	Sewing settings.....	52
	Adjusting the upper thread tension.....	52
	Adjusting the maximum sewing speed.....	52
	Programming the securing stitches.....	52
	Adjusting the hovering height of the presser foot.....	52
	Programming the button «Pattern end».....	53
	Programming the button «Thread cutter».....	54
	Adjusting the presser foot position with needle stop down.....	54
	Programming the button «Quick reverse».....	55
	Programming the foot control.....	55
3.2	Embroidery settings.....	56
	Adjusting the upper thread tension.....	56
	Adjusting the maximum embroidering speed.....	56
	Centering or opening embroidery motifs in the original position.....	56
	Calibrating the hoop.....	57
	Entering the fabric thickness.....	58
	Activating/Deactivating the function thread away.....	58
	Programming the securing stitches.....	58
	Adjusting the thread cut.....	59
	Changing the measuring unit.....	60
3.3	Selecting personal settings.....	60



3.4	Monitoring functions .....	61
	Activating the upper thread indicator .....	61
	Activating the bobbin thread indicator .....	61
3.5	Activating the audio signals.....	61
3.6	Machine settings.....	62
	Selecting a language .....	62
	Adjusting the brightness of the display .....	62
	Adjusting the sewing light .....	63
	Calibrating the display .....	63
	Back to default setting.....	63
	Deleting user data .....	64
	Deleting motifs on the BERNINA USB Stick.....	64
	Calibrating the Buttonhole foot No. 3A .....	65
	Updating the machine Firmware .....	65
	Recovering saved data .....	66
	Cleaning the thread catcher .....	66
	Lubricating the machine .....	67
	Packing the embroidery module .....	67
	Checking the firmware version .....	68
	Reviewing the total number of stitches .....	68
	Registering details of the dealer.....	69
	Saving Service data.....	69
<b>4</b>	<b>System settings.....</b>	<b>70</b>
4.1	Calling up the Tutorial.....	70
4.2	Calling up the Creative Consultant.....	70
4.3	Calling up the Help .....	70
4.4	Using eco mode .....	70
4.5	Cancelling any alterations with «clr» .....	70
<b>5</b>	<b>Creative sewing .....</b>	<b>71</b>
5.1	Overview selection menu sewing.....	71
	Selecting a stitch pattern .....	71
5.2	BERNINA Dual Feed.....	72
	Application of the BERNINA Dual Feed.....	72
5.3	Regulating the speed .....	73
5.4	Adjusting the upper thread tension .....	73
5.5	Editing stitch patterns .....	74
	Changing the stitch width .....	74
	Changing the stitch length .....	74
	Correcting the balance .....	75
	Programming pattern repeat .....	76
	Programming long stitch .....	76
	Mirror image of stitch patterns .....	76
	Editing stitch pattern length .....	76
	Programming the stitch counter function.....	77
	Quick reverse.....	77
	Permanent Quick reverse .....	77
	Backstepping.....	78



5.6	Combining stitch patterns .....	78
	Overview Combi mode .....	78
	Creating Stitch pattern combinations .....	78
	Saving a stitch pattern combination .....	79
	Loading a stitch pattern combination .....	79
	Overwriting a stitch pattern combination .....	79
	Deleting a stitch pattern combination .....	79
	Editing a single stitch pattern .....	80
	Deleting a single stitch pattern .....	80
	Adding a single stitch pattern .....	81
	Mirroring a stitch pattern combination .....	81
	Stitch pattern combination Subdivider 1 .....	82
	Stitch pattern combination Subdivider 2 .....	82
	Securing a stitch pattern combination .....	82
	Programming pattern repeat .....	83
5.7	Administering stitch patterns .....	83
	Saving settings of stitch patterns .....	83
	Saving stitch patterns in personal memory .....	83
	Overwriting stitch patterns from the personal memory .....	83
	Loading stitch patterns from the personal memory .....	84
	Deleting stitch patterns from the personal memory .....	84
	Saving stitch patterns on the BERNINA USB stick .....	84
	Uploading a stitch pattern from the BERNINA USB stick .....	84
	Deleting stitch patterns from the BERNINA USB stick .....	85
5.8	Securing .....	85
	Securing with the button «Pattern end» .....	85
	Securing via the icon «Securing» .....	85
5.9	Height Compensation of uneven layers .....	86
5.10	Sewing Corners .....	86
<b>6</b>	<b>Practical stitches .....</b>	<b>87</b>
6.1	Overview Practical stitches .....	87
6.2	Sewing straight stitch .....	89
6.3	Securing with the automatic Securing Program .....	90
6.4	Sewing in the zipper .....	90
6.5	Sewing both sides of the zipper from bottom to top .....	91
6.6	Sewing Triple straight stitch .....	92
6.7	Sewing Triple zig zag .....	93
6.8	Manual darning .....	93
6.9	Automatic darning .....	95
6.10	Reinforced darning, automatic .....	96
6.11	Finishing edges .....	96
6.12	Sewing Double overlock .....	97
6.13	Narrow edgestitching .....	98
6.14	Wide edgestitching .....	98
6.15	Edgestitching using the seam guide .....	98
6.16	Sewing hem edges .....	99
6.17	Sewing blind hems .....	100





6.18	Sewing visible hems .....	101
6.19	Sewing flat joining seams.....	101
6.20	Sewing basting stitches .....	102
<b>7</b>	<b>Decorative stitches .....</b>	<b>103</b>
7.1	Overview Decorative Stitches.....	103
7.2	Bobbin-Play.....	104
7.3	Altering the stitch density.....	105
7.4	Sewing cross stitches.....	105
7.5	Pintucks .....	106
	Pintucks.....	106
	Overview pintucks .....	106
	Inserting the cord .....	107
	Sewing Pintucks .....	107
<b>8</b>	<b>Alphabets .....</b>	<b>108</b>
8.1	Overview Alphabet.....	108
8.2	Creating lettering.....	108
8.3	Altering font size.....	109
<b>9</b>	<b>Buttonholes.....</b>	<b>110</b>
9.1	Overview Buttonholes .....	110
9.2	Making use of the height compensation tool .....	111
9.3	Using the compensation plate .....	112
9.4	Marking buttonholes.....	112
9.5	Cord .....	113
	Using cord with the Buttonhole foot with slide No. 3A .....	113
	Using cord with the Buttonhole foot No. 3C (optional accessory).....	114
9.6	Sewing a test sample .....	115
9.7	Determining the buttonhole slit width.....	116
9.8	Determining the buttonhole length via the Buttonhole foot with slide No. 3A .....	116
9.9	Determining the buttonhole length with Buttonhole foot No. 3C (optional accessory) .....	116
9.10	Sewing a buttonhole automatically .....	117
9.11	Programming the Heirloom buttonhole .....	118
9.12	Sewing the manual 7-step buttonhole with the Buttonhole foot No. 3C (optional accessory). .....	118
9.13	Sewing the manual 5-step buttonhole with the Buttonhole foot No. 3C (optional accessory). .....	119
9.14	Cutting the buttonhole open with the seam ripper.....	120
9.15	Cutting open buttonholes with the buttonhole cutter (optional accessory) .....	121
9.16	Sewing on buttons.....	121
9.17	Sewing eyelets .....	122
<b>10</b>	<b>Quilting .....</b>	<b>123</b>
10.1	Overview Quilt Stitches .....	123
10.2	Quilting, Securing Program .....	124
10.3	Sewing handlook quilt stitches .....	125
10.4	Guiding the quilt work freely.....	125



<b>11 BERNINA Stitch Regulator (BSR)</b> .....	<b>127</b>
11.1 BSR mode 1 .....	127
11.2 BSR mode 2 .....	127
11.3 BSR function with Straight stitch No. 1 .....	127
11.4 BSR function with Zig zag No. 2 .....	127
11.5 Sewing preparations for quilting .....	127
Attach the BSR presser foot .....	127
Changing the presser foot sole .....	128
11.6 Using the BSR mode.....	128
11.7 Securing.....	129
Securing in BSR1 mode with the button «Start/Stop» .....	129
Securing in BSR2 mode.....	130
<b>12 My BERNINA Embroidery</b> .....	<b>131</b>
12.1 Overview Embroidery module.....	131
12.2 Supplied accessories Embroidery module.....	131
Overview accessory Embroidery module.....	131
12.3 Overview User Interface .....	133
Overview functions/visual information .....	133
Overview System settings .....	133
Overview Selection menu embroidery .....	134
12.4 Important Embroidery information .....	134
Upper thread.....	134
Bobbin thread .....	135
Choosing the embroidery motif .....	135
Selecting the embroidery file format .....	135
Embroidery test .....	135
The size of the embroidery motif .....	135
Embroidering motifs by third-party providers .....	136
Underlay stitches .....	136
Satin or Leaf stitch .....	136
Step stitch .....	137
Connecting stitches .....	137
<b>13 Embroidering preparation</b> .....	<b>138</b>
13.1 Attaching the Module .....	138
13.2 Preparing the machine .....	139
Lowering the feed dog .....	139
Selecting an embroidery motif .....	139
13.3 Embroidery foot.....	139
Attaching the embroidery foot .....	139
Selecting the presser foot in the User Interface .....	140
13.4 Needle and stitch plate.....	140
Inserting the embroidery needle .....	140
Selecting the embroidery needle in the User Interface.....	141
Selecting the needle type and the needle size .....	141
Attaching the stitch plate .....	142
Selecting the stitch plate in the User Interface.....	143
Thread-up command.....	143



13.5	Embroidery hoop .....	143
	Overview Embroidery hoop selection .....	143
	Selecting the embroidery hoop .....	144
	Tear-away stabilizers.....	144
	Cut-away stabilizers.....	144
	Using adhesive spray .....	144
	Using spray starch .....	144
	Using iron-on interfacing .....	144
	Using paper-backed adhesive stabilizer .....	145
	Using water-soluble stabilizer .....	145
	Preparing the embroidery hoop .....	145
	Attaching the hoop .....	146
	Overview Embroidery functions .....	147
	Center the needle to the embroidery hoop .....	147
	Moving the hoop to the back .....	147
	Moving the module for the sewing mode .....	147
	Grid on/off .....	148
	Locating the center of the embroidery motif .....	148
	Virtual positioning of the embroidery hoop.....	148
<b>14</b>	<b>Setup Program .....</b>	<b>149</b>
14.1	Adjusting the embroidery settings in the Setup Program .....	149
<b>15</b>	<b>Creative embroidering .....</b>	<b>150</b>
15.1	Overview embroidering .....	150
15.2	Selecting and changing the embroidery motif .....	150
15.3	Checking the embroidery time and the embroidery motif size .....	150
15.4	Regulating the speed .....	151
15.5	Editing the embroidery motif.....	151
	Overview Editing embroidery motif .....	151
	Scaling up the embroidery motif view .....	151
	Downsizing the embroidery motif view .....	151
	Moving the embroidery motif view .....	152
	Moving the embroidery motif in enlarged view .....	152
	Moving the embroidery motif .....	152
	Rotating motif .....	153
	Altering the embroidery motif size proportionally .....	153
	Altering the embroidery motif size disproportionately .....	154
	Mirroring embroidery motifs.....	154
	Changing the stitch type .....	154
	Altering the stitch density .....	155
	Checking the size and the position of the embroidery motif .....	155
	Deleting an embroidery motif .....	156
15.6	Creating lettering.....	157
	Overview embroidery alphabets.....	157
	Creating words/sentences.....	157
	Editing words/sentences .....	158
15.7	Changing the colors of the embroidery motif .....	159
	Overview changing the color .....	159
	Changing the colors .....	159
	Changing the thread brand .....	159



15.8	Embroidering the embroidery motif.....	160
	Overview Embroidery menu.....	160
	Adding basting stitches.....	160
	Moving the hoop.....	160
	Embroidery sequence control when thread breaks.....	161
	Cutting connecting stitches.....	161
	Multi-colored embroidery motif on/off.....	161
	Color indication.....	162
15.9	Free arm embroidering.....	162
15.10	Administering embroidery motifs.....	163
	Administering embroidery motifs.....	163
	Saving embroidery motifs in the personal memory.....	163
	Saving the embroidery motif on the BERNINA USB stick.....	163
	Overwriting the embroidery motif in the personal memory.....	164
	Overwriting the embroidery motif on the BERNINA USB stick.....	164
	Importing stitch patterns.....	164
	Loading an embroidery motif from the personal memory.....	165
	Loading an embroidery motif from the BERNINA USB stick.....	165
	Deleting an embroidery motif from the personal memory.....	165
	Deleting an embroidery motif from the BERNINA USB stick.....	166
<b>16</b>	<b>Embroidery.....</b>	<b>167</b>
16.1	Embroidering via the button «Start/Stop».....	167
16.2	Increasing the embroidery speed.....	167
16.3	Adjusting the upper thread tension.....	167
16.4	Embroidering via the foot control.....	168
<b>17</b>	<b>Attachment.....</b>	<b>169</b>
17.1	Maintenacnce and cleaning.....	169
	Cleaning the display.....	169
	Cleaning the feed dog.....	169
	Cleaning the hook.....	169
	Lubricating the hook.....	170
17.2	Troubleshooting.....	172
17.3	Error messages.....	175
17.4	Storage and disposal.....	179
	Storing the machine.....	179
	Dispose of the machine.....	179
17.5	Technical data.....	180
<b>18</b>	<b>Overview stitch patterns.....</b>	<b>181</b>
18.1	Overview Stitch patterns.....	181
	Practical stitches.....	181
	Buttonholes.....	181
	Decorative stitches.....	181





## IMPORTANT SAFETY INSTRUCTIONS

Please be aware of the following basic safety instructions when using your machine. Before using this machine, read instruction manual carefully.

### DANGER!

To reduce the risk of electrical shock:

- Never leave the machine unattended as long as it is plugged in.
- Always unplug the machine from the electrical outlet immediately after using.

Protection against LED radiation:

- Do not view the LED light directly with optical instruments (e.g. magnifier). The LED light corresponds with protection class 1M.
- When the LED light is damaged or defective, contact your BERNINA specialist dealer.

### WARNING

To reduce the risk of burns, fire, electric shock or injury to persons:

- To operate the machine always use the supplied power cable. USA and Canada only: Do not connect power plug NEMA 1-15 to circuits exceeding 150 volt-to-ground.
- Use this machine only for purposes as described in this manual.
- Only use the machine in dry rooms.
- Do not use the machine in a damp condition or in a damp environment.
- Do not use this machine as a toy. Close attention is necessary when this machine is used by or near children.
- The machine can be used by children older than 8 or by people with reduced physical, sensory or mental capabilities or if there is a lack of experience and knowledge how to operate the machine as long as they are supervised or have been given instruction concerning the responsible use of the appliance and are aware of the involved risks.
- Children are not allowed to play with this machine.
- Cleaning and maintenance work must not be carried out by children unless they are supervised.
- Never operate this machine if it has a damaged cord or plug, if it is not working properly, if it has been dropped or damaged, or dropped into water. Contact the nearest authorized BERNINA dealer to arrange further details.





## Important information

### Availability of the instruction manual

The instruction manual is supplied with the machine.

- Keep the instruction manual safe at a suitable place near the machine to have it at hand in case that you need to look up something.
- If you pass the machine to a third party, always include the instruction manual.

### Appropriate use

Your BERNINA machine is conceived and designed for private household use. It answers the purpose to quilt fabrics as it is described in this instruction manual. Any other use is not considered appropriate. BERNINA assumes no liability concerning consequences resulting from an inappropriate usage.

### Servicing of double-insulated products

In a double-insulated product two systems of insulation are provided instead of grounding. No grounding means is provided on a double-insulated product, nor should a means for grounding be added to the product. Servicing a double-insulated product requires extreme care and knowledge of the system and should be done only by qualified service personnel. Replacement parts for a double-insulated product must be identical to the original parts in the product. A double-insulated product is marked with the words: «Double insulation» or «double-insulated».

 The symbol may also be marked on the product.

### Environmental Protection

BERNINA is committed to the protection of the environment. We strive to minimize the environmental impact of our products by continuously improving product design and our technology of manufacturing.



The machine is labeled with the symbol of the crossed-out wastebin. This means that the machine must not be disposed of with the household waste when the machine is no longer needed. Improper disposal can result in dangerous substances getting into the groundwater and thus into our food chain, damaging our health.

The machine must be returned free of charge to a nearby collection point for waste electrical and electronic equipment or to a collection point for the reuse of the machine. Information on the collection points can be obtained from your local administration. When purchasing a new machine, the dealer is obliged to take back the old machine free of charge and dispose of it properly.

If the machine contains personal data, you are responsible for deleting the data yourself before returning the machine.





# 1 My BERNINA

## 1.1 Introduction

On your BERNINA 765 SE you can sew, embroider and quilt. Delicate silk or satin fabrics as well as heavy-weight linen, fleece and denim can be sewn without any problems with this machine. Numerous practical as well as decorative stitches, buttonholes and embroidery motifs are at your disposal.

Additional to this instruction manual, three help programs are provided which will give you useful advice and support at any time how to operate your BERNINA 765 SE.

The **Tutorial** gives information and explanations, covering various aspects of sewing, embroidering and the different stitches.

The **Creative Consultant** informs you about decision support for sewing projects. After entering the kind of fabric and the desired sewing project, suggestions concerning the suitable needle or the appropriate presser foot are displayed.

The **Help Program** provides information about individual stitch patterns, functions and operations in the user interface.

The BERNINA 765 SE offers the same functions and features like a BERNINA 770 QE.

### Further information

In addition to this instruction manual of your BERNINA 765 SE further information products are enclosed.

The latest version of your instruction manual as well as additional information in connection with the machine and accessories can be found on our website <http://www.bernina.com>

## 1.2 BERNINA Quality control

All BERNINA machines are assembled with utmost care and are subjected to an extensive functionality test. The integrated stitch counter therefore indicates that the machine has already sewn stitches, which were performed exclusively for test purposes and quality control. The subsequent thorough cleaning does not exclude the possibility that thread remnants may still be found in the machine.

## 1.3 Welcome to the world of BERNINA

«Made to create», is BERNINA's slogan. Not only our machines do support you to implement your ideas. On top of that, our below mentioned opportunities also offer various inspirations and instructions for your future projects as well as the option to exchange ideas with other sewing and embroidering enthusiasts. We wish you lots of pleasure doing that.

### BERNINA YouTube Channel

On YouTube we offer a wide range of how-to videos and support concerning the most important functions of our machines. Detailed explanations are also provided as for the various presser feet, so that your projects will succeed completely.

<http://www.youtube.com/BerninaInternational>

Provided in the languages English and German.

### inspiration – the sewing magazine

Are you looking for ideas, sewing patterns and instructions for great projects? In that case the BERNINA magazine «inspiration» is exactly what you need. «inspiration» offers extraordinary sewing and embroidery ideas four times a year. From seasonal fashion trends to trendy accessories and practical tips to decorate your home in an original way.

<http://www.bernina.com/inspiration>

The magazine is available in the languages English, German, Dutch and French. Not available in all countries.

### **BERNINA Blog**

Fancy instructions, free sewing patterns and embroidery motifs as well as many new ideas: all this you can find in the weekly blog by BERNINA. Our experts give valuable tips and explain step by step how you can achieve the desired result. In the community you can upload your own projects and exchange experiences and ideas with other sewing and embroidering enthusiasts.

<http://www.bernina.com/blog>

Provided in the languages English, German and Dutch.

### **BERNINA Social Media**

Follow us on the social networking to learn more about events, thrilling projects as well as tips and tricks all about sewing and embroidering. We will keep you informed and we are looking forward to presenting you the one or the other highlight from the world of BERNINA.

<http://www.bernina.com/social-media>

## **1.4 Explanation of symbols**



Labels a danger with a high risk which can lead to death or severe injury unless it is avoided.



Labels a danger with a medium risk which can lead to death or severe injury unless it is avoided.



Designates a hazard with low risk that can cause minor or moderate injury if not avoided.



Designates a hazard that can cause property damage if not avoided.



**Tips** given by BERNINA **sewing experts** can be found next to this symbol.

By means of illustration, sample pictures are used in this instruction manual. The machines and accessories shown in the pictures do not necessarily correspond to the actual items delivered with your machine.



## 1.5 Overview Machine

### Overview front controls



- |   |                      |   |                            |
|---|----------------------|---|----------------------------|
| 1 | Quick reverse        | 6 | Needle up/down             |
| 2 | Thread cutter        | 7 | Upper Multifunctional knob |
| 3 | Presser foot up/down | 8 | Lower Multifunctional knob |
| 4 | Start/Stop           | 9 | Needle left/right          |
| 5 | Pattern end          |   |                            |

### Overview front



- |   |   |    |                                   |
|---|---|----|-----------------------------------|
| 1 | Connection for embroidery module              | 7  | Slide speed control               |
| 2 | Bobbin cover                                  | 8  | Thread take-up lever cover        |
| 3 | Connection for accessory (optional accessory) | 9  | Thread take-up lever              |
| 4 | Presser foot                                  | 10 | Fixing screw                      |
| 5 | Needle threader                               | 11 | Connection for the slide-on table |
| 6 | Sewing light                                  | 12 | Connection for Free Hand System   |

## Overview sideways



- |   |                                 |    |                                   |
|---|---------------------------------|----|-----------------------------------|
| 1 | Connection for foot control     | 7  | Power switch                      |
| 2 | PC-connection                   | 8  | Connection for power cable        |
| 3 | Spool pin                       | 9  | Magnet holder for touchscreen pen |
| 4 | Winding unit with thread cutter | 10 | Air vents                         |
| 5 | Swiveling spool pin             | 11 | USB port                          |
| 6 | Handwheel                       | 12 | Feed dog up/down                  |

## Overview back



- |   |   |    |                   |
|---|---|----|-------------------|
| 1 | Connection for the slide-on table             | 9  | Thread pretension |
| 2 | Connection for darning hoop                   | 10 | Thread guide      |
| 3 | BSR connection                                | 11 | Fixing screw      |
| 4 | Connection for accessory (optional accessory) | 12 | BERNINA Dual Feed |
| 5 | Air vents                                     | 13 | Thread cutter     |
| 6 | Thread guide                                  | 14 | Feed dog          |
| 7 | Bobbin winding unit                           | 15 | Stitch plate      |
| 8 | Carrying handle                               |    |                   |

## 1.6 Supplied accessories

### Overview accessories machine

**All rights reserved:** For technical reasons and for the purpose of product improvements, changes concerning the features of the machine can be made at any time and without advance notice. The supplied accessory can vary depending on the country of delivery.

Please visit [www.bernina.com](http://www.bernina.com) for more accessory information.



Illustration	Name	Purpose
	Soft Cover with pocket	To protect the machine from dust and contamination.
	Accessory box	To store the supplied accessories as well as the optional accessories.
	Free Hand System (FHS)	To raise and lower the presser foot.
	Slide-on table	To increase the sewing surface.
	CutWork/Straight stitch plate	To sew straight stitches and for CutWork.
	Spool disc	To support the regular unwinding of the thread from the spool.  3 different sizes for thread spools in different sizes.
	Bobbin 4 pieces, 1 of them in the machine	To wind the bobbin thread.









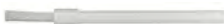



Illustration	Name	Purpose
	Foam pad 2 pieces	To prevent the thread from slipping under the spool holder, tangling and breaking.
	Touchscreen pen	For precise operation of the touch display.
	Seam ripper	To undo seams and to cut buttonholes open.
	Height compensating tool	To level an angled position of the presser foot sole when sliding over thick seams.
	Selection of needles	For any common applications.
	Seam guide, right	To align regular seam distances.
	Screwdriver Torx, gray	To change the needle.
	Screwdriver red (slot)	To loosen and tighten slotted screws.
	Angular Torx wrench Torx	To open the headframe.
	Brush	to clean the feed dog and the hook race area.
	Oil pen	To fill up the oil depots.
	Power cable	To connect the machine with the power supply system.











Illustration	Name	Purpose
	Foot control	To start and stop the machine. To control the sewing speed.

### Use of the power cable (only USA/Canada)

The machine has a polarized plug (one blade wider than the other). To reduce the risk of electrical shock, this plug is intended to fit in a polarized outlet only one way. If the plug does not fit fully in the outlet, reverse the plug. If it still does not fit, contact a qualified electrician to install the proper outlet. Do not modify the plug in any way!

### Overview presser feet

Supplied standard presser feet

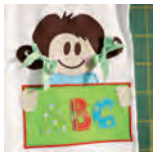
Illustration	Number	Name	Purpose	Example
	# 1C	Reverse pattern foot	To sew various practical and decorative stitches. To sew forward and in reverse.	
	# 1D	Reverse pattern foot	To sew various practical and decorative stitches with Dual Feed. To sew forward and in reverse.	
	# 3A	Automatic Buttonhole foot with slide	To sew buttonholes automatically.	
	# 4D	Zipper foot	To sew in zippers with Dual Feed.	
	# 20C	Open embroidery foot	To sew appliqués and decorative patterns.	

## Accessory box

**All rights reserved:** For technical reasons and for the purpose of product improvements, changes concerning the features of the machine can be made at any time and without advance notice. The supplied accessory can vary depending on the country of delivery.

The illustrated accessory (kind and quantity) serves as an example and doesn't have to correspond with the supplied accessory.

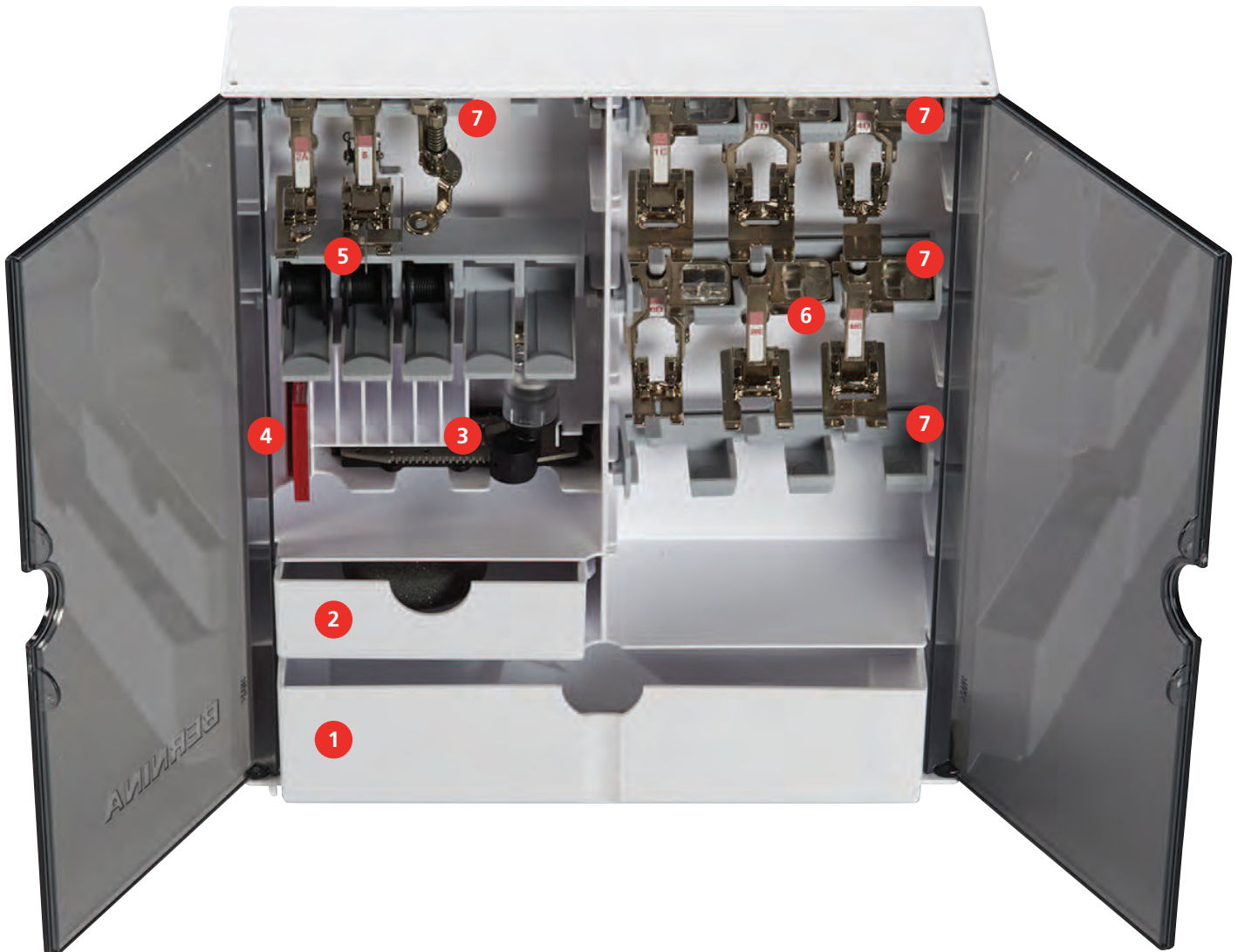

- |   |                                      |   |   |
|---|--------------------------------------|---|---|
| 1 | Big drawer                           | 5 | Spool holder                                    |
| 2 | Small drawer                         | 6 | Presser feet                                    |
| 3 | Automatic Buttonhole foot with slide | 7 | Presser foot holders for 5.5 mm and 9.0 mm feet |
| 4 | Selection of needles                 |   |   |

## 1.7 Overview User Interface

### Overview functions/visual information



- |   |                        |   |                                |
|---|------------------------|---|--------------------------------|
| 1 | Upper thread tension   | 4 | Stitch plate/Needle selection  |
| 2 | Presser foot indicator | 5 | Feed dog up/down               |
| 3 | Presser foot pressure  | 6 | Filling level of bobbin thread |

### Overview System settings

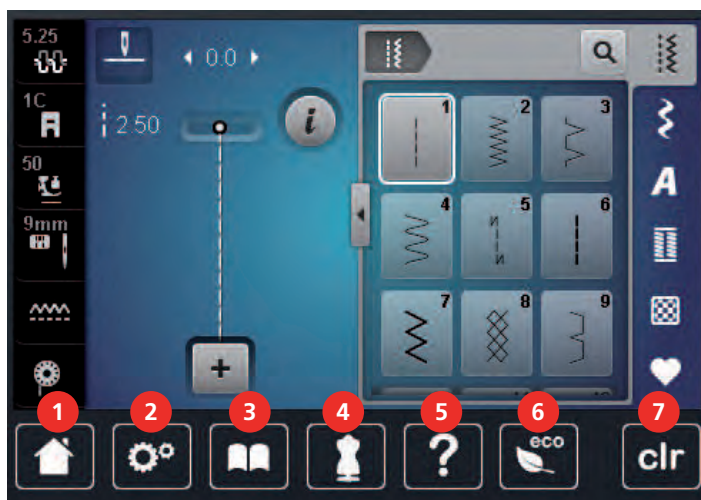







- |   |                     |   |                         |
|---|---------------------|---|-------------------------|
| 1 | Home                | 5 | Help                    |
| 2 | Setup Program       | 6 | eco mode                |
| 3 | Tutorial            | 7 | Back to default setting |
| 4 | Creative Consultant |   |                         |



## Overview selection menu sewing

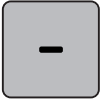
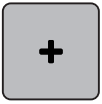

- |   |                     |   |                 |
|---|---------------------|---|-----------------|
| 1 | Practical stitches  | 4 | Buttonholes     |
| 2 | Decorative stitches | 5 | Quilt stitches  |
| 3 | Alphabets           | 6 | Personal Memory |

## Overview Icons

Icon	Name	Purpose
	i-Dialog	Touching the icon «i»-Dialog provides various functions to edit motifs.
	Close	The display is closed and the previously made adjustments are saved.
 	Icons «-/+»	By touching the icons «-» and «+» the setting values are changed.
	Yellow frame around the icon	A yellow-framed icon indicates that a setting or a value in this function has been changed. By touching the yellow-framed icon, the default setting can be restored.
	Confirm	Confirms the previously adjusted alterations. The display is closed.
	Cancel	The process is canceled. The display is closed and the previously made adjustments are not saved.

Icon	Name	Purpose
	Slide	By moving the slide the setting values are changed.
	Switch	Activates or deactivates functions.
	Process navigation	With the process navigation scrolling back in the display is possible.
	Swipe function	By swiping the display using the touchscreen pen or the finger upwards or downwards, further functions can be displayed.

## 1.8 Needle, Thread, Fabric

In the course of time a needle wears out. Therefore it should be replaced regularly. Only a perfect point results in a good stitching result. In general it can be said: the thinner the thread, the finer the needle. The illustrated needles are either standard or optional accessory, depending on the machine.

- Needle sizes 70, 75: for thin fabrics.
- Needle sizes 80, 90: for medium fabrics.
- Needle sizes 100, 110 and 120: for heavy fabrics.

### Overview Needles

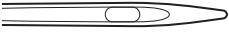



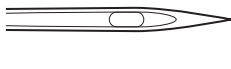



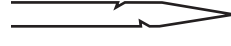

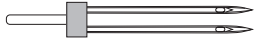



Illustration	Needle name	Needle description	Purpose
 ☒	<b>Universal needle</b> 130/705 H 60-120	Slightly rounded point	For nearly all natural and synthetic fabrics (woven and knitted).
 ■	<b>Stretch needle</b> 130/705 H-S 75, 90	Mid-sized ball point, special eye shape and needle scarf	For jersey, tricot, knit and stretch fabrics.
 ■	<b>Jersey/Embroidery needle</b> 130/705 H SUK 60-100	Mid-sized ball point	For knitware, knitted good. For embroidering.
 ■	<b>Jeans needle</b> 130/705 H-J 80-110	Point, narrow point, reinforced shaft	For heavy-weight fabrics such as jeans or canvas.
 ■	<b>Leather needle</b> 130/705 H LR 90, 100	With cutting point (LR = special point to sew leather)	For all types of leather, synthetic leather, plastic, sheeting.
 ■	<b>Microtex needle</b> 130/705 H-M 60-110	Especially sharp, narrow point	For micro fiber fabrics and silk.

Illustration	Needle name	Needle description	Purpose
 ■	<b>Quilting needle</b> 130/705 H-Q 75, 90	Slightly rounded fine point	For straight and topstitching.
 ■	<b>Embroidery needle</b> 130/705 H-E 75, 90	Small ball point, especially wide needle eye and wide thread groove	For embroidery on all natural and synthetic fabrics.
 ☒	<b>Fine-material needle</b> 130/705 H SES 70, 90	Small ball point	For fine knitware and knitted materials.  For embroidery on fine, delicate fabrics.
 ■	<b>Metafil needle</b> 130/705 H METAFIL 80	Long needle eye (2 mm) in all needle sizes	For sewing or embroidering with metallic threads.
 ■	<b>Cordonnet needle (to patch embroidery)</b> 130/705 H-N 70-100	Long needle eye (2 mm) in all needle sizes	Topstitching with thick thread.
	<b>Felt needle</b> PUNCH	Needle with barbed hook	For felt work.
 ☒	<b>Hemstitch needle</b> 130/705 H WING 100-120	Wing-like widened needle shaft (wing)	To sew blind stitches.
 ☒	<b>Universal double needle</b> 130/705 H ZWI 70-100	Needle distance: 1.0/1.6/2.0/2.5/3.0/4.0/6.0/8.0	For visible hems in stretch fabrics, pintucks, decorative sewing.
 ☒	<b>Stretch double needle</b> 130/705 H-S ZWI 75	Needle distance: 2.5/4.0	For visible hems in stretch fabrics, pintucks, decorative sewing.
 ☒	<b>Hemstitch double needle</b> 130/705 H ZWIHO 100	Needle distance: 2.5	For special effects with hemstitch embroidery.
 ☒	<b>Universal triple needle</b> 130/705 H DRI 80	Needle distance: 3.0	For visible hems in stretch fabrics, decorative sewing.

## Example for needle description

The 130/705 system, which is the most common for household machines, is explained by the following picture of a Jersey/Stretch needle.

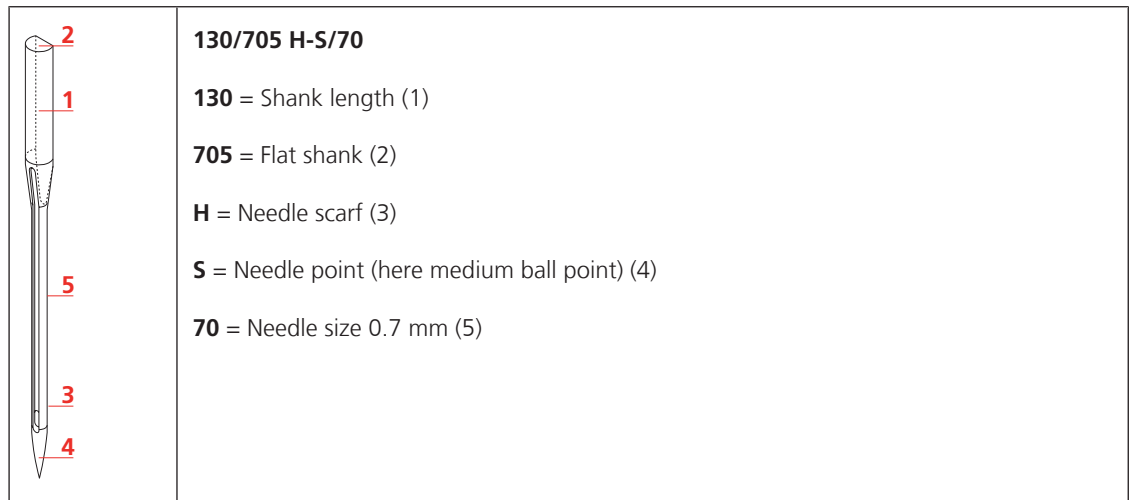

## Thread selection

For a perfect sewing result, thread and fabric quality play an important role.

We recommend purchasing quality threads to achieve good sewing results.

- Cotton threads have the advantage of being a natural fiber and therefore are especially suitable for sewing cotton fabrics.
- Mercerized cotton threads have a slight sheen that is not lost with washing.
- Polyester threads have a high tensile strength and is particularly colorfast.
- Polyester threads are more flexible and are recommended where a strong and elastic seam is required.
- Rayon threads are made of natural fibers and have a brilliant sheen.
- Rayon threads are suitable for decorative stitches and achieve a more beautiful effect.

### Needle/thread combination

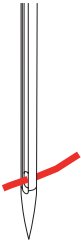
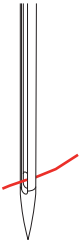
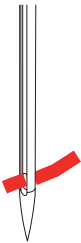
	<p>The needle/thread combination is correct, when the thread fits perfectly into the long groove and goes easily through the needle eye. The thread can be optimally secured.</p>
	<p>The thread can break and skipped stitches can occur when there is too much clearance in the long groove and the needle eye.</p>
	<p>The thread can break and get stuck when the thread scrapes against the edge of the long groove not fit well into the needle eye optimally.</p>





## 2 Sewing preparation

### 2.1 Accessory box

#### Accessory box free standing

- > On the back of the box, pull both extensions out until they click into place.



#### Storing accessory

##### NOTICE

#### Incorrect sorting of the bobbin

The silvery sensor surface can get scratched.

- > Make sure that the silvery sensor surfaces are on the right side when sorting the bobbins into the accessory box.
- 
- > Insert the holders (1) for bobbins, feet and needles.
  - > Store the small parts, e.g. thread discs etc., in the drawers (2) and (3).
  - > Store the Buttonhole foot with slide No. 3A in compartment (4).
  - > Store the provided needle package in the special compartment (5).
  - > Insert the bobbins into the compartment (6) of the accessory box so that the silvery sensor surfaces are on the right side.
  - > To remove a bobbin, press the compartment holder down.
  - > Store the presser feet in the holders (7) (5.5 mm or 9.0 mm).

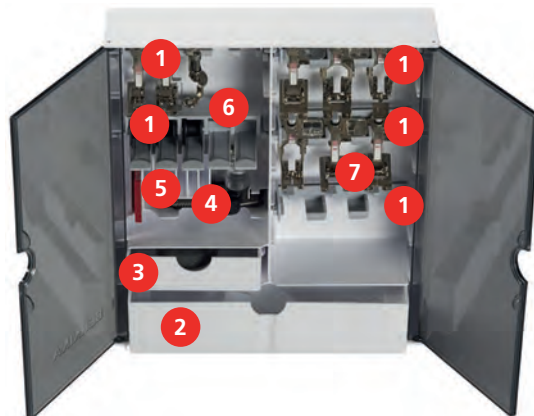

## 2.2 Connection and Switching on

### Connecting the foot control

- > Unwind the cable of the foot control to the desired length.



- > Insert the cable of the foot control into the foot control connection.



### Connecting the machine

- > Insert the power cable into the power cord connection.



- > Insert the power cable into the power cord connection.



## Attaching the knee lifter of the Free Hand System



The lateral position of the knee lifter can be adjusted by your local BERNINA Dealer if required.

- > Insert the knee lifter into the opening at the front side of the machine.
- > Adjust the sitting height so that the knee lifter can be operated with the knee.

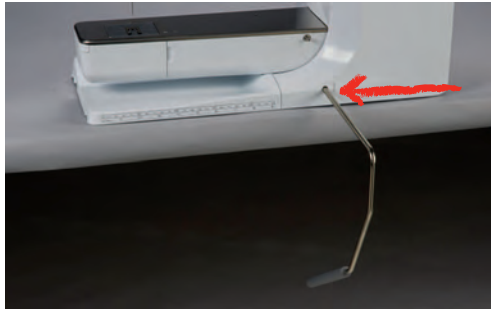

## Fixing the touchscreen pen

- > Store the touchscreen pen at the magnet holder.



## Switching the machine on

- > Switch on the machine at the main switch to «I».



## 2.3 Foot control

### Regulating the speed via the foot control

Via the foot control the speed is infinitely variable.

- > Press the foot control down carefully to start the machine.
- > To sew faster, press the foot control harder.
- > Release the foot control to stop the machine.



### Raising/Lowering the needle

- > Sink the heel back on the foot control to raise/lower the needle.



### Programming the foot control individually

The foot control, i. e. the back kick function can be programmed individually (see page 55).

## 2.4 Spool pin

### Swiveling spool pin

Installing the spool holder



With metallic or other special threads, it is recommend to use the swiveling spool pin.

The swiveling spool holder is necessary when several threads are sewn and it can also be used for bobbin winding while sewing.

- > Swivel the spool holder up as far as it will go.



#### Inserting foam pad and thread spool

The foam pad prevents the thread from getting hooked at the swiveling spool holder.

- > Place the foam pad on the swiveling spool holder.
- > Place the thread spool on the spool holder.



#### Horizontal spool pin

Placing the foam pad, the thread spool and the spool disc

The spool disc provides an even unwinding of the thread from the thread spool. The spool disc is only used with the horizontal spool pin.

- > Place the foam pad on the spool pin.
- > Place the thread spool on the spool pin.
- > Position the appropriate spool disc on the spool pin so that there is no space between the spool disc and the thread spool.



#### Using a spool net

The spool net provides an even unwinding of the thread from the thread spool and prevents the thread from knotting and breaking. The spool net is only used with the horizontal spool holder.

- > Pull the spool net over the thread spool.



## 2.5 Free arm

The BERNINA 765 SE provides a solidly designed free arm which offers a lot of space for large project on the right of the needle.

## 2.6 Feed dog

### Adjusting the feed dog

**NOTICE**

Inappropriate handling of the fabric

Damage of the needle and the stitch plate.

- > Let the sewing project be fed evenly.

With each stitch, the feed dog moves forward by one step. The length of this step is determined by the stitch length selected.

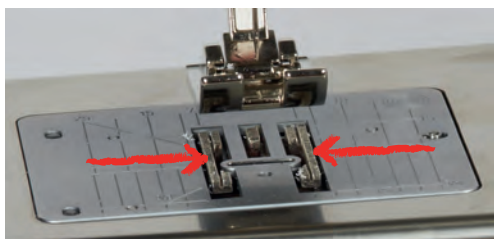

With a short stitch length, the steps are very short. For example when sewing buttonholes and satin stitches. The fabric is fed slowly under the presser foot, even when sewing at maximal speed.

	<p>Let the fabric be fed evenly; this results in a more perfect stitch formation.</p>
	<p>Pulling or pushing the fabric will result in uneven stitches.</p>

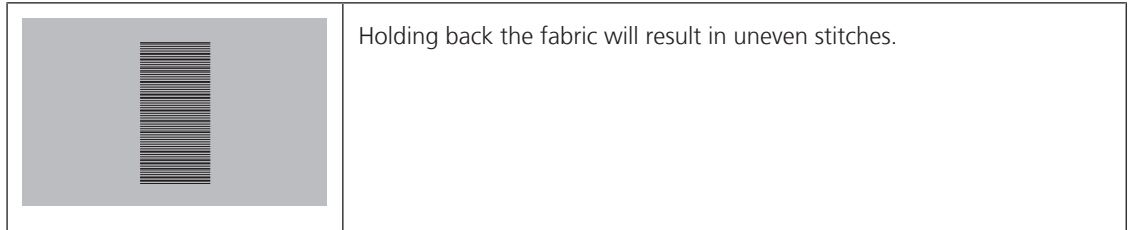

- > Push the button «Feed dog up/down» to lower the feed dog.



- > Push the button again to sew with the feed dog up.

## 2.7 Slide-on table

### Using the slide-on table

When attached to the free arm, it expands the already existing sewing area.

- > Raise the needle.
- > Raise the presser foot.
- > Switch the machine off and disconnect it from the power supply system.
- > Push the slide-on table to the right over the free arm until it engages.



- > To remove the slide-on table, press the button at the table down and pull the slide-on table over the free arm to the left.



## 2.8 Presser foot

### Adjusting the presser foot position via the knee lifter of the Free Hand System

- > Adjust the sitting height so that the knee lifter can be operated with the knee.
- > Push the knee lifter with the knee to the right to raise the presser foot.

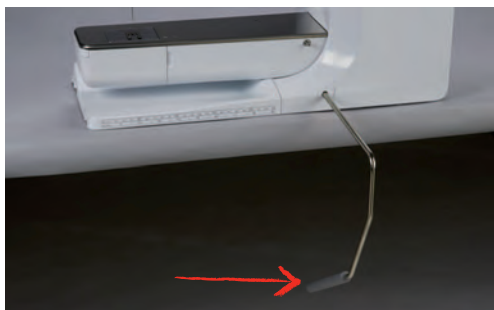

- Simultaneously the feed dog is lowered and the thread tension is released.
- > Release the knee lifter slowly to lower the presser foot.

### Adjusting the presser foot position via the button «Presser foot up/down»



- > Push the button «Presser foot up/down» to raise the presser foot.
- > Push the button «Presser foot up/down» again to lower the presser foot.

### Changing the presser foot

- > Raise the needle.
- > Raise the presser foot.
- > Switch the machine off and disconnect it from the power supply system.
- > Push the clamping lever up.



- > Remove the presser foot.
- > Guide the new presser foot upwards over the cone.
- > Press the clamping lever down.

### Having the presser foot displayed in the User Interface

The recommended presser foot for the selected stitch is displayed. In addition to that, optional presser feet can be displayed.

- > Switch the machine on.
- > Select a stitch pattern.
  - In the icon «Presser foot display» the recommended presser foot is indicated with a number.



- > Touch the icon «Presser foot display».
- > With the touchscreen pen/finger scroll up within the range of presser feet to have optional presser feet displayed.



- > If a presser foot is touched, the description and the application for this presser foot is displayed.



### Adjusting the presser foot pressure



The presser foot pressure is designed to adjust the pressure of the presser foot optimally to the fabric thickness. When working with thick fabrics, it is recommended to reduce the presser foot pressure. This provides the advantage that the presser foot is slightly lifted so that the fabric can be moved more easily. When working with thin fabrics, it is recommended to increase the presser foot pressure. This provides the advantage that the fabric cannot be moved too easily under the presser foot.



- > Touch the icon «Presser foot pressure».
- > Move the slide with the touchscreen pen/finger to adjust the presser foot pressure.

## 2.9 Instruction for adjusting the feed dog



- > Touch the icon «Feed dog up/down».
- > Raise or lower the feed dog according to the animation.

## 2.10 Needle and stitch plate

### Changing the needle

- > Raise the needle.
- > Switch the machine off and disconnect it from the power supply system.
- > Remove the presser foot.
- > Loosen the fixing screw of the needle using the screwdriver gray Torx.



- > Pull the needle down.
- > Hold the new needle with the flat side to the back.
- > Insert the needle as far as it will go.
- > Tighten the fixing screw of the needle using the screwdriver gray Torx.

### Selecting the needle in the User Interface

After having changed the needle, it can be checked whether or not it can be used in combination with the selected stitch plate.



- > Touch the icon «Stitch plate/Needle selection».



- > Select the inserted needle.

### Selecting the needle type and the needle size

Convenient memory function: To prevent a loss of information, the needle type and the needle size can be saved additionally on the machine. The saved needle type and the saved needle size can be checked at any time.



- > Touch the icon «Stitch plate/Needle selection».

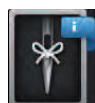

- > Touch the icon «Needle type/Needle size».
- > Select the needle type (1) of the inserted needle.
- > Select the needle size (2) of the inserted needle.



### Adjusting the needle position up/down



- > Push the button «Needle up/down» to lower the needle.
- > Push the button «Needle up/down» again to raise the needle.

### Adjusting the needle position left/right

There is a total of 11 needle positions. The needle position is indicated by the needle position number in the display.

- > Push the button «Needle left» (1) to move the needle to the left.
- > Push the button «Needle right» (2) to move the needle to the right.



### Needle stop up/down (permanent)



- > Touch the icon «Needle stop up/down (permanent)» to fix the needle position permanently.
  - The machine stops with needle position down as soon as the foot control is released or the button «Start/Stop» has been pressed.
- > Touch the icon «Needle stop up/down (permanent)» again.
  - The machine stops with needle position up as soon as the foot control is released or the button «Start/Stop» has been pressed.

### Changing the stitch plate

The stitch plate is marked with vertical, horizontal and diagonal lines in millimeters (mm) and inches (inch). These lines help to guide the fabric when sewing seams and precise topstitching.

Prerequisite:

- The feed dog is lowered.
- The machine is switched off and disconnected from the power supply system.
- Needle and presser foot are removed.

- > Press the stitch plate down at the mark back right until it flips up.



- > Remove the stitch plate.
- > Place the openings of the new stitch plate above the corresponding guide pins and press down until it clicks into place.

### Selecting the stitch plate in the User Interface

After having changed the stitch plate, it can be checked whether or not it is suitable to be used in combination with the selected needle.



- > Touch the icon «Stitch plate/Needle selection».
- > Select the previously attached the stitch plate.



- If the selected stitch plate is suitable in combination with the needle, sewing can be started.
- If the selected stitch plate is not suitable in combination with the needle, starting the machine is automatically blocked.

## 2.11 Threading

### Threading the upper thread

Prerequisite:

- The needle and the presser foot are raised.
- The machine is switched off and disconnected from the power supply system.
- > Place the foam pad on the spool holder.
- > Place the thread spool on the spool holder so that the thread unwinds clockwise.
- > Add the appropriate spool disc.
- > Guide the thread in direction of the arrow through the rear thread guide (1) and hold the thread with the hands so that it is taut and can be inserted into the thread tension.

- > Guide the thread in direction of the arrow through the thread tension (2).

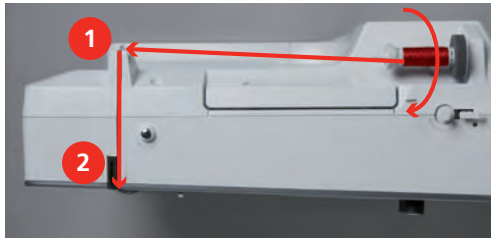

- > Guide the thread downwards (3) around the thread take-up lever cover (4).
- > Guide the thread upwards and insert into the thread take-up lever (5).
- > Guide the thread downwards again (6).



- > Guide the thread through the guides (7/8) above the presser foot.

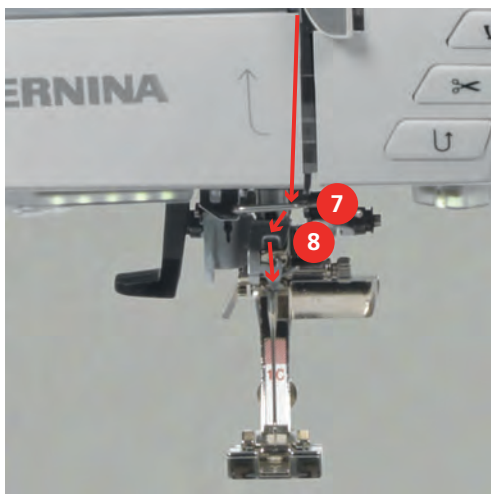

- > Switch the machine on.



- > Press the semi-automatic threader lever (9) slightly down, keep pressed and pull the thread to the left beneath the gray threader hook (10).



- > Guide the thread around the gray threader hook from the left to the right (12).
- > Press the threader lever down as far as it will go (11) and then pull the thread from the left to the right (12) through the threader slot (13) until it hooks into the small wire hook.

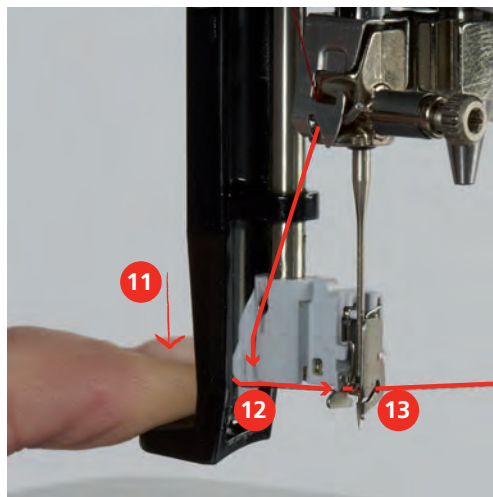

- > Release the lever and the thread simultaneously to thread.
- > Pull the thread loop (14) to the back.

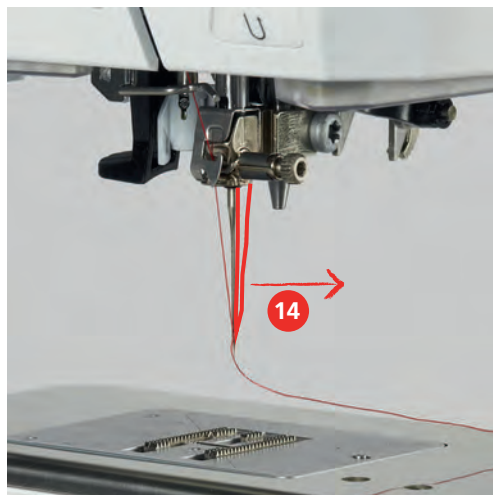

- > Pull the thread beneath the presser foot from back to front over the thread cutter (15) and cut.



### Threading the double needle

Prerequisite:

- The double needle is inserted.
- > Guide the first thread in direction of the arrow on the right side of the tension disc (1).
- > Guide the second thread in direction of the arrow on the left side of the tension disc (1).

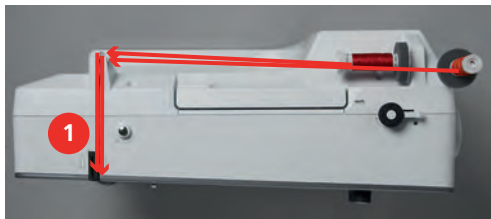

- > Guide the first and the second thread to the thread guide above the needle.
- > Thread the first thread manually into the right needle.
- > Thread the second thread manually into the left needle.



### Threading the triple needle

Always attach a foam pad when using the swiveling spool holder. This prevents the thread from getting hooked at the spool holder.



Prerequisite:

- The triple needle is inserted.
- > Place the foam pad, the thread spool and the appropriate spool disc on the spool holder.
- > Place the filled bobbin on the swiveling spool holder.
- > Add the appropriate spool disc.
- > Place the thread spool.
- > Thread the 3 threads up to the upper thread guide.

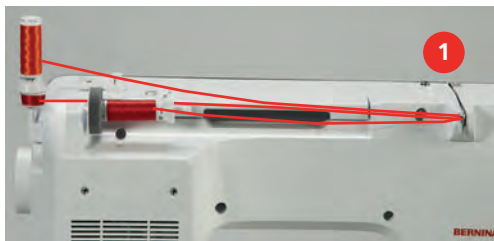

- > Guide 2 threads past the thread tension discs (1) on the left and to the thread guide above the needle.
- > Guide 1 thread past the thread tension discs (1) on the right and to the thread guide above the needle.
- > Thread the first thread into the left needle manually.
- > Thread the second thread into the center needle manually.
- > Thread the third thread into the right needle manually (see page 47).

## Winding the bobbin thread



The bobbin thread can be wound while embroidering if the swiveling spool holder is used for winding.

Prerequisite:

- The foam pad, the thread spool and the appropriate thread disc are positioned.
- > Attach the empty bobbin on the winding unit (1) so that the silvery sensor surface is down.



- > Guide the thread to the left into the rear thread guide (2).
- > Guide the thread around the thread pretension clockwise (3).
- > Wind the thread clockwise 2 to 3 times around the empty bobbin (4).

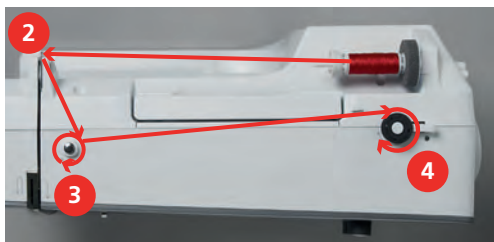



- > Pull the excess thread over the thread cutter at the engaging lever (5) and cut.



- > Push the engaging lever (6) towards the bobbin.



- The machine winds and the display to wind the bobbin appears.
- > Move the slide on the display using the touchscreen pen/finger to adjust the winding speed.
- > To stop the winding process, the engaging lever must be pressed to the right.
- > Push the engaging lever towards the bobbin again to continue the winding process.
  - As soon as the bobbin is full, the machine stops the winding process automatically.
- > Remove the bobbin and cut the thread using the thread cutter at the engaging lever.

### Threading the bobbin thread

Prerequisite:

- The needle is raised.
- The machine is switched off and the bobbin cover is opened.
- > Press the bobbin case release at the bobbin case (1).

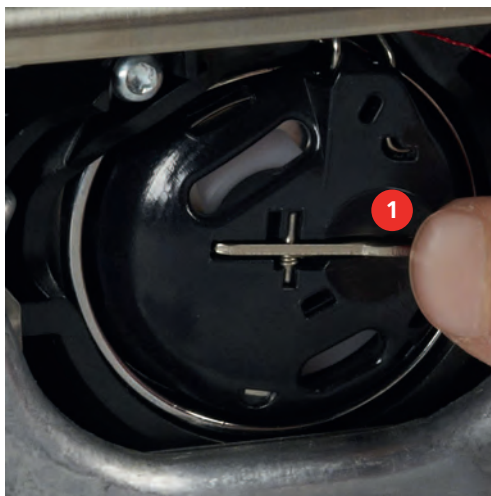

- > Remove the bobbin case.
- > Remove the bobbin from the bobbin case.

- > Insert the new bobbin so that the silvery sensor surface is facing the back of the bobbin case.



- > Pull the thread into the slot (2) from the left.



- > Pull the thread to the right under the spring (3), then lead the thread under the two thread guides (4) and pull upwards.



- > When inserting into the machine, hold the bobbin case so the thread guide (5) points upwards.

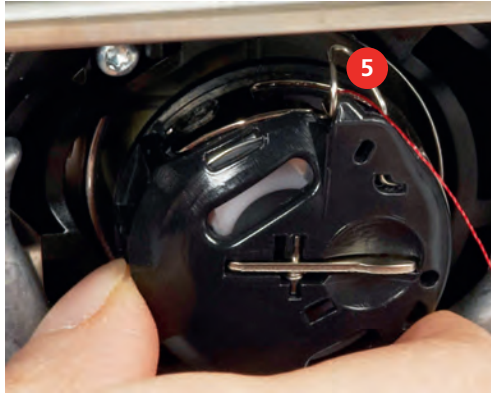

- > Insert the bobbin case.
- > Press onto the center of the bobbin case until it engages.
- > Pull the thread through the thread cutter (6) and cut.

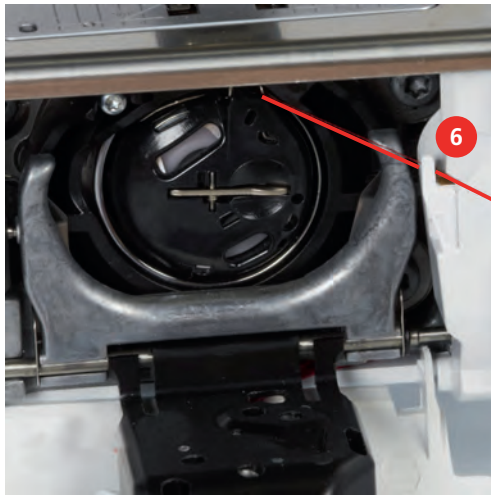

- > Close the bobbin cover.

### Indicating fill level of bobbin thread

As soon as the fill level of the bobbin thread is low, an animation, which indicates that the bobbin thread is running out, appears in the icon «Bobbin thread fill level».



- > Touch the icon «Bobbin thread fill level» to thread the bobbin thread according to the animation.

## 3 Setup Program

### 3.1 Sewing settings

#### Adjusting the upper thread tension

Adjustments to the upper thread tension in the Setup Program affect all stitch patterns. Individual alteration of the upper thread tension can also be made for currently selected stitches.



> Touch the icon «Setup Program».



> Touch the icon «Sewing settings».



> Touch the icon «Alter the upper thread tension».

> Move the slide using the touchscreen pen/finger or touch the icons «+» or «-» to alter the upper thread tension.

#### Adjusting the maximum sewing speed

By using this function, the maximum speed can be reduced.



> Touch the icon «Setup Program».



> Touch the icon «Sewing settings».



> Touch the icon «Alter the maximum speed».

> Move the slide using the touchscreen pen/finger or touch the icons «+» or «-» to alter the maximum speed.

#### Programming the securing stitches

If the function is activated, 4 securing stitches are sewn automatically at the pattern start after the thread cut.



> Touch the icon «Setup Program».



> Touch the icon «Sewing settings».



> Touch the switch using the touchscreen pen/finger to deactivate the securing stitches.

> Touch the switch again to activate the securing stitches.

#### Adjusting the hovering height of the presser foot

The hovering height of the presser foot can be adjusted according to the fabric thickness from 0 to maximal 7 mm.



> Touch the icon «Setup Program».



> Touch the icon «Sewing settings».



> Touch the icon «Program buttons and icons».



> Touch the icon «Program the hovering position of the presser foot».  
 > To adjust the distance between the fabric and the presser foot, turn the «Upper Multifunction knob» or the «Lower Multifunction knob» or touch the irons «-» or «+».

### Programming the button «Pattern end»

The presser foot can be positioned, the thread cut and the automatic securing can be programmed.



> Touch the icon «Setup Program».



> Touch the icon «Sewing settings».



> Touch the icon «Program buttons and icons».



> Touch the icon «Program pattern end».



> Touch the icon «Secure» to sew 4 securing stitches in place.



> Touch the icon «Alter the number of securing stitches» to program subsequent securing stitches.  
 > Touch the icons «-» or «+» to program the number of securing stitches in close succession.

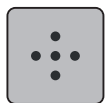

> Touch the icon «Securing stitches in place» to program 4 securing stitches in place.



> Touch the icon «Thread cut» to deactivate the automatic thread cut after securing.  
 > Touch the icon «Thread cut» again to activate the automatic thread cut after securing.



> Touch the icon «Position the presser foot» so that the presser foot remains down after securing.  
 > Touch the icon «Position the presser foot» again so that the presser foot remains up after securing.



> Touch the icon «Secure» to deactivate the automatic securing.  
 > Touch the icon «Secure» again to activate the automatic securing.

### Programming the button «Thread cutter»

The automatic securing can be programmed before the thread cut takes place.



> Touch the icon «Setup Program».



> Touch the icon «Sewing settings».



> Touch the icon «Program buttons and icons».



> Touch the icon «Program the button thread cutter».



> Touch the icon «Secure» to program 4 securing stitches in place.



> Touch the icon «Number of securing stitches» to program the number of securing stitches in close succession.

> Touch the icons «-» or «+» to program the number of securing stitches.



> Touch the icon «Securing stitches in place» to program 4 securing stitches in place.



> Touch the icon «Securing» to deactivate the automatic securing.

> Touch the icon «Securing» again to activate the automatic securing.

### Adjusting the presser foot position with needle stop down

With lowered needle, 3 different presser foot position can be selected: the presser foot lowered, the presser foot is raised to hovering position and the presser foot is raised to its maximum height.



> Touch the icon «Setup Program».



> Touch the icon «Sewing settings».



> Touch the icon «Program buttons and icons».



> Touch the icon «Adjust the presser foot position with needle stop down».



> Select the desired presser foot position.

## Programming the button «Quick reverse»

It can be chosen either «Quick reverse permanent» or «Backstepping».



> Touch the icon «Setup Program».



> Touch the icon «Sewing settings».



> Touch the icon «Program buttons and icons».



> Touch the icon «Program Quick reverse».



> Touch the icon «Backstepping» to activate backstepping.

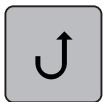

> Touch the icon «Quick reverse permanent» to activate the permanent reverse sewing.

## Programming the foot control

When the icon «Needle up/down» is activated, the needle is raised or lowered via a back kick on the foot control. Alternatively, the presser foot can be positioned, the thread can be cut and the automatic securing can be programmed.



> Touch the icon «Setup Program».



> Touch the icon «Sewing settings».



> Touch the icon «Program the foot control».

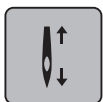





- The icon «Needle up/down» is activated by default.
- The back kick on the foot control raises or lowers the needle.



> Touch the icon «Program the back kick» to program the back kick.





> To program 4 securing stitches in place, touch the icon «Securing».

- 
  - > To program securing stitches in close succession, touch the icon «Alter the number of securing stitches».
  - > To program the number of securing stitches, touch the icons «-» or «+».
  - > To reset any alterations to default setting, touch the yellow-framed icon.
- 
  - > To program 4 securing stitches in place, touch the icon «Securing stitches in place».
- 
  - > To deactivate the automatic securing via the back kick, touch the icon «Securing».
  - > To activate the automatic securing via the back kick, touch the icon «Securing» again.
- 
  - > To deactivate the automatic thread cut, touch the icon «Thread cut».
  - > Touch the icon «Thread cut» again to activate the thread cut via the back kick.
- 
  - > Touch the icon «Position the presser foot» so that the presser foot remains down via the back kick.
  - > Touch the icon «Position the presser foot» again so that the presser foot remains up via the back kick.

## 3.2 Embroidery settings



### Adjusting the upper thread tension

Alterations of the upper thread tension in the Setup Program affect all embroidery motifs.

- 
  - > Touch the icon «Setup Program».
- 
  - > Touch the icon «Embroidery settings».
- 
  - > Touch the icon «Alter the upper thread tension».
  - > Move the slide using the touchscreen pen/finger or touch the icons «+» or «-» to alter the upper thread tension.

### Adjusting the maximum embroidering speed

By using this function, the maximum speed can be reduced.

- 
  - > Touch the icon «Setup Program».
- 
  - > Touch the icon «Embroidery settings».
- 
  - > Touch the icon «Alter the maximum speed».
  - > Move the slide using the touchscreen pen/finger or touch the icons «+» or «-» to alter the maximum speed.

### Centering or opening embroidery motifs in the original position

When the embroidery motif is opened on the machine, it is always centered to the embroidery hoop. If you want the embroidery motif to be opened in its original position (defined by the BERNINA embroidery software), the function «Center the embroidery motif» must be activated.







> Touch the icon «Setup Program».



> Touch the icon «Embroidery settings».



> Touch the icon «Center the embroidery motif».



- > Press the switch in the right section.
  - A previously moved embroidery motif which has been saved in the new position is opened in the saved position after selecting.
- > Press the switch in the right section again.
  - The embroidery motif is centered to the embroidery hoop.

### Calibrating the hoop

The calibration of the embroidery hoop is the coordination of the needle to the center of the embroidery hoop.

Prerequisite:

- The embroidery module is connected and the embroidery hoop with the appropriate embroidery template is attached.



> Touch the icon «Setup Program».



> Touch the icon «Embroidery settings».



- > Touch the icon «Calibrate the embroidery hoop».
- > Select the desired embroidery hoop and follow the instructions in the display.
- > Center the needle via the arrow icons on the display.

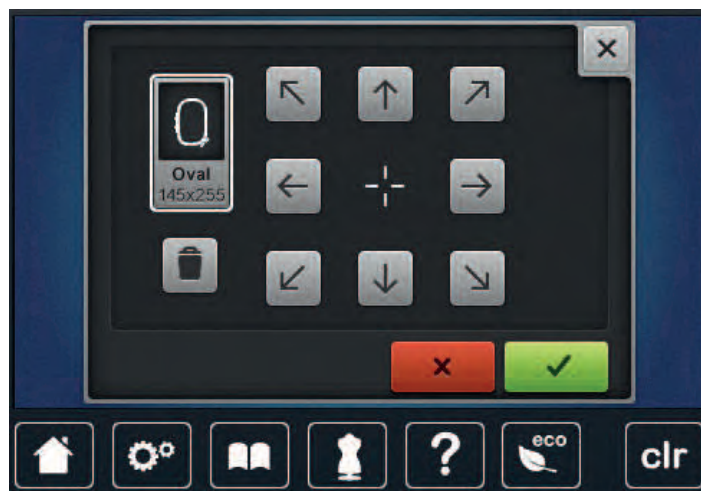

### Entering the fabric thickness

If the fabric thickness is more than 4 mm as for e.g. toweling, it is recommended to select 7.5 mm or 10 mm. The thicker the fabric, the slower the embroidery speed of the machine. When the machine is switched off, the alterations are reset to the default setting 4 mm.



> Touch the icon «Setup Program».



> Touch the icon «Embroidery settings».



> Touch the icon «Select the fabric thickness».  
> Select fabric thickness.

### Activating/Deactivating the function thread away

To pull the thread end out of the fabric being cut, the function must be activated. For embroidery motifs with long stitches, it is recommended to deactivate the function thread away. When the distance between the presser foot and the embroidery hoop is too short, the function is not carried out.



> Touch the icon «Setup Program».



> Touch the icon «Embroidery settings».



> Touch the icon «Thread away».



> To activate the function thread away, set the switch to «1».  
> To deactivate the function thread away, set the switch to «0».

### Programming the securing stitches

Embroidery motifs are programmed either with or without securing stitches. The machine recognizes when no securing stitches are programmed and adds some. If securing stitches are not wanted, they can be deactivated.



> Touch the icon «Setup Program».



> Touch the icon «Embroidery settings».



> Touch the icon «Securing stitches on/off».



> Press the switch in the upper right section to deactivate the securing stitches at the start.  
– If the embroidery motif has programmed securing stitches, they will be embroidered.  
– If the embroidery motif doesn't have any programmed securing stitches, none are embroidered.

- > Press the switch again to activate the securing stitches at the start.
  - If the embroidery motif has programmed securing stitches, they will be embroidered.
  - If the embroidery motif doesn't have any programmed securing stitches, the securing stitches are added and will be embroidered.
- > Press the switch in the lower right section to deactivate the securing stitches at the end.
  - If the embroidery motif has programmed securing stitches, they will be embroidered.
  - If the embroidery motif doesn't have any programmed securing stitches, none are embroidered.
- > Press the switch again to activate the securing stitches at the end.
  - If the embroidery motif has programmed securing stitches, they will be embroidered.
  - If the embroidery motif doesn't have any programmed securing stitches, the securing stitches are added and will be embroidered.

### Adjusting the thread cut



- > Touch the icon «Setup Program».



- > Touch the icon «Embroidery settings».



- > Touch the icon «Thread cut settings».



- > Touch the switch in the upper portion of the display (1) to deactivate the automatic thread cut before the thread is changed.
- > Touch the switch in the upper portion of the display (1) again to activate the automatic thread cut before the thread is changed.
- > Touch the switch in the middle section of the display (2) to stop machine after about 7 stitches and the remaining thread can be cut manually.
- > Touch the switch in the middle section of the display (2) again and the machine won't stop for a manual thread cut.
- > Touch the icons «-» or «+» (3) to adjust the length from where the connecting stitches are cut.
- > Touch the yellow-framed icon on the left side to reset the alteration to default setting.

## Changing the measuring unit

The measuring unit in the embroidery mode can be changed from mm to inch. The standard setting is in mm.



> Touch the icon «Setup Program».



> Touch the icon «Embroidery settings».



- > Touch the icon «Change measuring unit».
- > Touch the icon «Inch» (2) to change the measuring unit in the embroidery mode to inch.
- > Touch the icon «mm» (1) to change the measuring unit in the embroidery mode to mm.



## 3.3 Selecting personal settings



> Touch the icon «Setup Program».



- > Touch the icon «Personal settings».
- > Select the desired color of the display and the background.
- > Touch the text box above the color settings.

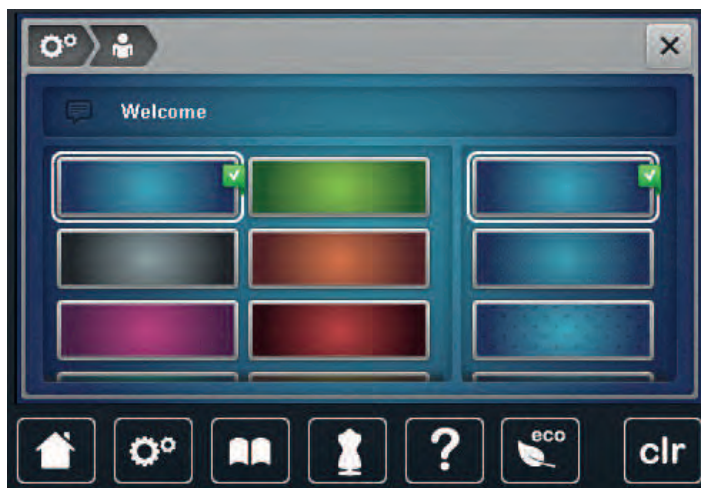

- > Enter the welcome text.
- > Touch the icon «ABC» (standard setting) to use upper-case letters.
- > Touch the icon «abc» to use lower-case letters.
- > Touch the icon «123» to use figures and mathematical symbols.
- > Touch the icon «@&!» to use special characters.
- > Touch the text box above the keyboard to delete the entered text completely.
- > Touch the icon «DEL» to delete individual syllables of the entered text.



- > Touch the icon «Confirm».

### 3.4 Monitoring functions

#### Activating the upper thread indicator



- > Touch the icon «Setup Program».



- > Touch the icon «Monitoring settings».



- > Touch the switch in the upper portion of the display to deactivate the upper thread indicator.
- > Touch the switch again to activate the upper thread indicator.

#### Activating the bobbin thread indicator



- > Touch the icon «Setup Program».



- > Touch the icon «Monitoring settings».



- > Touch the switch in the lower section of the display to deactivate the bobbin thread indicator.
- > Touch the switch again to activate the bobbin thread indicator.

### 3.5 Activating the audio signals



- > Touch the icon «Setup Program».



- > Touch the icon «Audio signals».
- > Touch the switch (1) to deactivate any audio signals in general.
- > Touch the switch (1) again to activate any audio signals in general.
- > In the section (2) touch the icons «1 – 4» to set up the desired signal for the selection of a stitch pattern.
- > In the section (2) touch the icon «Loudspeaker» to deactivate the signal for the selection of a stitch pattern.
- > In the section (3) touch the icons «1 – 4» to activate the signal for the selection of functions.



- > In the section (3) touch the icon «Loudspeaker» to deactivate the signal for the selection of functions.





- > In the section (4) touch the icon «Loudspeaker» to deactivate the signal when using the BSR modes.
- > In the section (4) touch the icon «Loudspeaker» again to activate the signal when using the BSR modes.



### 3.6 Machine settings

#### Selecting a language

The User Interface can be programmed in different languages according to the customer's wish because BERNINA provides a wide range of international languages for the customers. Via firmware updates additional languages for the User Interface can be provided.



- > Touch the icon «Setup Program».



- > Touch the icon «Machine settings».



- > Touch the icon «Language selection».
- > Select a language.

#### Adjusting the brightness of the display

The brightness of the display can be adjusted corresponding to the personal preferences.



- > Touch the icon «Setup Program».



- > Touch the icon «Machine settings».



- > Touch the icon «Adjust the brightness».
- > Move the slide in the upper portion of the display using the touchscreen pen/finger or touch the icons «+» or «-» to alter the brightness of the display.

## Adjusting the sewing light

The brightness of the sewing light can be adjusted corresponding to the personal preferences.



- > Touch the icon «Setup Program».



- > Touch the icon «Machine settings».



- > Touch the icon «Adjust the brightness».
- > Move the slide in the upper portion of the display using the touchscreen pen/finger or touch the icons «+» or «-» to alter the brightness of the sewing light.



- > Touch the switch to switch the sewing light off.
- > Touch the switch again to switch the sewing light on.

## Calibrating the display

Please find further information on this topic in the chapter attachment below troubleshooting at the end of the instruction manual.



- > Touch the icon «Setup Program».



- > Touch the icon «Machine settings».



- > Touch the icon «Calibrate the display».
- > Touch the crosses in sequence using the touchscreen pen.

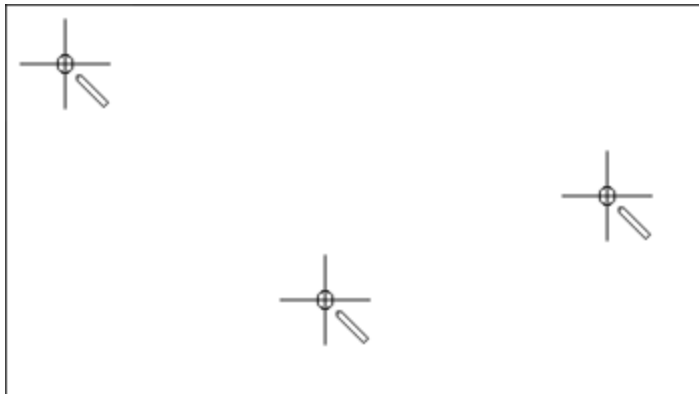

## Back to default setting

**ATTENTION:** Using this function will delete all individually made settings.



- > Touch the icon «Setup Program».



- > Touch the icon «Machine settings».



> Touch the icon «Default settings».



> Touch the icon «Default setting sewing».



> Touch the icon «Confirm» to restore the default settings for the sewing settings.



> Touch the icon «Default setting embroidery».



> Touch the icon «Confirm» to restore the default settings for the embroidery settings.



> Touch the icon «Default setting all».



> Touch the icon «Confirm» and restart the machine to restore all default settings.

### Deleting user data

Motifs which are not needed anymore can be deleted so that there will be more capacity for new motifs.



> Touch the icon «Setup Program».



> Touch the icon «Machine settings».



> Touch the icon «Default settings».



> Touch the icon «Delete data from the personal memory».



> Touch the icon «Confirm» to delete all data from the personal memory.



> Touch the icon «Delete personal embroidery motifs».



> Touch the icon «Confirm» to delete all embroidery motifs from the personal memory.

### Deleting motifs on the BERNINA USB Stick

When motifs which won't be needed anymore are saved on the BERNINA USB Stick (Optional accessory), the stick can be connected to the machine and the data can be deleted.

> Insert the BERNINA USB Stick (Optional accessory) into the den USB port of the machine.

> Touch the icon «Setup Program».



> Touch the icon «Machine settings».



> Touch the icon «Basic settings».





> Touch the icon «Delete data from USB Stick».



> Touch the icon «Confirm» to delete all data on the BERNINA USB Stick (Optional accessory).

### Calibrating the Buttonhole foot No. 3A

The Buttonhole foot No. 3A is calibrated to this machine and they should only be used both together.

Prerequisite:

- The Buttonhole foot No. 3A is attached.
- The needle is not threaded.



> Touch the icon «Setup Program».



> Touch the icon «Machine settings».



> Touch the icon «Maintenance/Update».



> Touch the icon «Calibrate the Buttonhole foot with slide No. 3A».



> Touch the button «Start/Stop» to start the calibration.

### Updating the machine Firmware

The latest firmware of the machine and a detailed step-by-step instruction for updating processes can be downloaded at [www.bernina.com](http://www.bernina.com). In general, personal data and settings are automatically transferred during a firmware update. For reasons of safety, it is also recommended to save data and settings on a BERNINA USB stick (optional accessory) before the firmware update is started. If personal data and settings should get lost during a firmware update, they can be transferred to the machine again afterwards.

#### NOTICE

The BERNINA USB stick (optional accessory) has been removed too early

Firmware has not been updated and the machine cannot be used.

> Remove the BERNINA USB stick (optional accessory) only after the update has been completed successfully.

> Insert the BERNINA USB stick (optional accessory), FAT32 formatted, providing the latest software into the port.



> Touch the icon «Setup Program».



> Touch the icon «Machine settings».

## Setup Program



> Touch the icon «Maintenance/Update».



> Touch the icon «Update the machine».



> Touch the icon «Save data on USB stick».  
– The icon is checkmarked in green.



> Touch the icon «Update» to start the update of the firmware.

### Recovering saved data

If personal data and settings after a software update are not available anymore, they can be transferred to the machine again afterwards.

#### NOTICE

The BERNINA USB stick (optional accessory) has been removed too early

Saved data cannot be transferred and the machine cannot be used.

> Remove the BERNINA USB stick (optional accessory) only after the saved data has been transferred successfully.

> Insert the BERNINA USB stick (optional accessory) providing the saved data and settings into the USB port of the machine.



> Touch the icon «Setup Program».



> Touch the icon «Machine settings».



> Touch the icon «Maintenance/Update».



> Touch the icon «Update the machine».



> Touch the icon «Transfer saved data to machine».  
– The icon is checkmarked in green.

### Cleaning the thread catcher

In chapter «Maintenance and cleaning» there are additional illustrated step-by-step instructions.



> Touch the icon «Setup Program».



> Touch the icon «Machine settings».



> Touch the icon «Maintenance/Update».



> Touch the icon «Clean the thread catcher».  
> Clean the thread catcher according to the instructions on the display.

## Lubricating the machine

The Setup Program provides animations how the machine has to be oiled. In chapter «Maintenance and cleaning» there are additional illustrated step-by-step instructions. Always use BERNINA oil to lubricate.



CAUTION

### Electronically driven components

Risk of injury near the needle and the hook.

> Switch the machine off and disconnect it from the power supply system.

NOTICE

### Lubricating the hook

Too much oil can pollute the fabric and the thread.

> Always sew a test sample first.



> Touch the icon «Setup Program».



> Touch the icon «Machine settings».



> Touch the icon «Maintenance/Update».



> Touch the icon «Lubricate the machine».  
> Lubricate the machine according to the instructions on the display.

## Packing the embroidery module

To pack the embroidery module into the original packaging without moving the embroidery arm manually, the embroidery arm needs to be brought to its packing position.

Prerequisite:

- The embroidery module is connected with the machine.



> Touch the icon «Setup Program».



> Touch the icon «Machine settings».



> Touch the icon «Maintenance/Update».



> Touch the icon «Pack position for the embroidery module».  
> Follow the instructions on the display.

### Checking the firmware version

Both the firmware and the hardware version of the machine and the attached embroidery module are displayed.



> Touch the icon «Setup Program».



> Touch the icon «Machine settings».



> Touch the icon «Information».



> Touch the icon «Firmware and hardware information».

### Reviewing the total number of stitches

The total number of stitches of the machine as well as the number of stitches since the last service carried out by the specialized BERNINA dealer are displayed.



> Touch the icon «Setup Program».



> Touch the icon «Machine settings».



> Touch the icon «Information».



> Touch the icon «Firmware und Hardware Informationen».



## Registering details of the dealer

The contact details of your specialized BERNINA dealer can be registered.



> Touch the icon «Setup Program».



> Touch the icon «Machine settings».



> Touch the icon «Information».



> Touch the icon «Dealer details» to enter the information of the specialized dealer.



> Touch the icon «Name of the shop» to enter the name of the specialized BERNINA dealer.



> Touch the icon «Address» to enter the address of the specialized BERNINA dealer.



> Touch the icon «Phone» to enter the telephone number of the specialized BERNINA dealer.



> Touch the icon «Internet» to enter the Internet homepage or the email address of the specialized BERNINA dealer.

## Saving Service data

Service data concerning the status quo of the machine can be saved on a BERNINA USB stick (Optional accessory) and then given to the BERNINA dealer this way.

> Insert a BERNINA USB stick (Optional accessory) which provides enough free memory space into the USB port.



> Touch the icon «Setup Program».



> Touch the icon «Machine settings».



> Touch the icon «Information».



> Touch the icon «Service data».

> Touch the icon «LOG».

– The icon «LOG» is outlined in white.

> Only when the icon is not outlined in white anymore, remove the BERNINA USB Stick (Optional accessory).

## 4 System settings

### 4.1 Calling up the Tutorial

The tutorial provides information and explanations on different sections concerning sewing and embroidering and the various stitches.



- > Touch the icon «Tutorial».
- > Select the desired topic to get information.

### 4.2 Calling up the Creative Consultant

The Creative Consultant provides information about decision support concerning sewing projects. After entering the fabric and the desired sewing project, suggestions for suitable needles, presser feet etc. are displayed.



- > Touch the icon «Creative Consultant».
- > Select the fabric to be sewn.
- > Select the sewing project.

### 4.3 Calling up the Help



- > Touch the window in the display where help is needed.
- > Touch the icon «Help» to start the help mode.
- > Touch the icon in the display where help is needed.
  - Assistance concerning the selected icon is displayed.

### 4.4 Using eco mode

During a longer interruption of work the machine can be set into a power save mode. The power save mode also serves as a child safety feature. Nothing can be selected in the display and the machine cannot be started.



- > Touch the icon «eco».
  - The display goes to sleep. The power consumption is reduced and the sewing light is off.
- > Touch the icon «eco» again.
  - The machine is ready for use.

### 4.5 Cancelling any alterations with «clr»

Any alterations to motifs can be reset to default setting. Exceptions are saved motifs which have been filed in the personal memory and monitoring functions.



- > Touch the icon «clr».

## 5 Creative sewing

### 5.1 Overview selection menu sewing

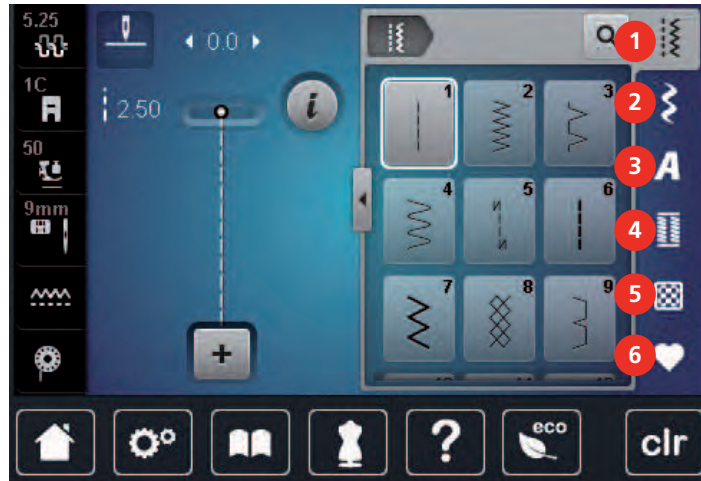

- |   |                     |   |                 |
|---|---------------------|---|-----------------|
| 1 | Practical stitches  | 4 | Buttonholes     |
| 2 | Decorative stitches | 5 | Quilt stitches  |
| 3 | Alphabets           | 6 | Personal Memory |

#### Selecting a stitch pattern

- > Select a stitch pattern, alphabet or buttonhole.
- > With the touchscreen pen/finger scroll up within the range of the practical stitches, alphabets or buttonholes to have more stitch patterns displayed.
- > Touch the icon «Display all the stitch patterns» (1) to scale up the view.
- > Touch the icon «Display all the stitch patterns» (1) again to downsize the stitch pattern view.



- > Touch the icon «Stitch pattern number entry» to select the stitch pattern via entering the stitch number.

## 5.2 BERNINA Dual Feed



It is recommended to match the presser foot pressure with the fabric. The thicker the fabric, the lower the presser foot pressure.

The BERNINA Dual Feed feeds the fabric from above and from beneath simultaneously. This provides an even and careful feed forward even for smooth and thin materials. Striped and checkered patterns can be matched perfectly by even feeding.

In general, the BERNINA Dual Feed is used for the following sewing projects:

- Sewing: All sewing applications with difficult fabrics such as for seams, zippers.
- Patchwork: With accurate stripes, blocks and with decorative stitches up to a stitch width of 9 mm.
- Appliqués: Sewing on ribbons and bias binding.

Difficult-to-work-with fabrics are:

- Velvet, normally sewn with the grain.
- Toweling.
- Jersey, especially when sewing it crosswise to knit.
- Fake fur or coated fake fur.
- Fleece-types of fabrics.
- Batted fabrics.
- Stripes and checks.
- Curtain fabrics with pattern repeats.

«Sticky» fabrics are:

- Imitation leather, coated fabrics (Dual Feed presser foot with sliding sole).

### Application of the BERNINA Dual Feed



Only use presser feet with a cut-out at the center back and the labeling «D». Additional presser feet with the labeling «D» are listed in the enclosed accessory catalog.

#### Activate Dual Feed

- > Raise the presser foot.
- > Attach a presser foot with the designation «D».
- > Pull the dual feed down until it engages.





### Deactivate Dual Feed

- > Raise the presser foot.
- > Hold the dual feed by the handle with two fingers, pull it down and then push it away from you and let it slide slowly upwards.



### 5.3 Regulating the speed

The sewing speed can be adjusted infinitely variable with the slide.

- > Move the slide to the left to reduce the sewing speed.
- > Move the slide to the right to increase the sewing speed.

### 5.4 Adjusting the upper thread tension

The basic setting of the upper thread tension is provided automatically as soon as a stitch pattern or an embroidery motif is selected.

The upper thread tension is set optimally at the BERNINA factory and the machine has been tested. Metrosene-/Seralon thread size 100/2 (Company Mettler, Switzerland) is used for upper and bobbin thread.

When of using other types of sewing or embroidery threads, the optimal tension may vary. Therefore it may be necessary to adjust the upper thread tension according to the sewing or embroidering project as well as the desired stitch pattern or the embroidery motif individually.

The higher the upper thread tension, the tighter the upper thread which means that the bobbin thread is pulled up to the top of the fabric. When the upper thread tension is low, the upper thread is less tightened which means that the bobbin thread is pulled up less.

Alterations of the upper thread tension affect the currently selected stitch pattern or embroidery motif. Permanent alterations of the upper thread tension for the sewing mode (see page 52) and for the embroidering mode (see page 56) can be made in the Setup Program.

Prerequisite:

- In the Setup Program the upper thread tension has been altered.
- > Touch the icon «Upper thread tension».



- > Move the slide using the touchscreen pen/finger to increase or reduce the upper thread tension.



- > Touch the yellow-framed icon on the right side to reset the alteration to default setting.
- > Touch the yellow-framed icon on the left side to reset the alteration to default setting in the **Setup Program**.

## 5.5 Editing stitch patterns

### Changing the stitch width

- > Turn the «Upper Multifunction knob» to the left to narrow the stitch width.
- > Turn the «Upper Multifunction knob» to the right to widen the stitch width.
- > To call up further setting options, touch the icon «Stitch width» (1).



### Changing the stitch length

- > Turn the «Lower Multifunction knob» to the left to shorten the stitch length.
- > Turn the «Lower Multifunction knob» to the right to elongate the stitch length.

- > To call up further setting options, touch the icon «Stitch length» (1).



### Correcting the balance

Different fabrics, threads and stabilizers can affect the programmed stitch patterns so that they cannot be sewn out correctly. The electronic balance can correct these deviation and the stitch pattern can be adjusted optimally to the selected fabric.

- > Select a stitch pattern or alphabet.
- > Touch the icon «i»-Dialog.



- > Touch the icon «Balance».
  - A preview of the stitch pattern is displayed.



- > To correct the vertical direction of the stitch pattern, turn the «Lower Multifunction knob» until the preview of the stitch pattern is in accordance with the sewn stitch on the fabric.
- > To save the alterations, close the preview window or touch the icon «i»-Dialog.

## Programming pattern repeat

Stitch patterns as well as stitch pattern combination can be repeated up to 9 times.

- > Select a stitch pattern or alphabet.
- > Touch the icon «i»-Dialog.



- > Touch the icon «Pattern repeat» once to sew the stitch pattern once.
- > Touch the icon «Pattern repeat» 2 to 9 times to repeat the stitch pattern up to 9 times.
- > Keep the icon «Pattern repeat» touched to deactivate the stitch pattern repeat.

## Programming long stitch

The maximum length for long stitches is 12 mm and the machine sews every second stitch.

- > Select a stitch pattern.
- > Touch the icon «i»-Dialog.

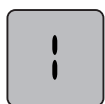

- > Touch the icon «Long stitch».

## Mirror image of stitch patterns

- > Select a stitch pattern or alphabet.
- > Touch the icon «i»-Dialog.



- > Touch the icon «Mirror image left/right» to mirror the stitch pattern from left to right.



- > Touch the icon «Mirror image up/down» to mirror the stitch pattern contrary to the sewing direction.

## Editing stitch pattern length

The stitch patterns can be lengthwise extended or shortened.

- > Select a stitch pattern or alphabet.
- > Touch the icon «i»-Dialog.



- > Touch the icon «Editing stitch pattern length».
- > Move the slide with the touchscreen pen/finger to determine the length of the stitch pattern.

- > Touch the icon «+100%» (1) to extend the stitch pattern length in 100%-steps.



### Programming the stitch counter function

The stitch counter function cannot be applied with all stitch patterns. If, for example, the honeycomb stitch has been selected, the stitch counter function cannot be used.

- > Select a stitch pattern.
- > Touch the icon «i»-Dialog.



- > Touch the icon «Program the length with the stitch counter».
- > Sew the desired length.

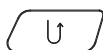

- > Push the button «Quick reverse».
  - The display changes to «Auto» and the selected stitch pattern in the new length is saved until the machine is switched off.

### Quick reverse

- > Select a stitch pattern, alphabet or buttonhole.
- > Program needle stop down (permanent) to switch immediately to Quick reverse as soon as the button «Quick reverse» is pressed.
- > Program needle stop up (permanent) to sew another stitch forward before the machine switches to reverse sewing.

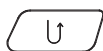

- > Push the button «Quick reverse» and keep pressed.

### Permanent Quick reverse

- > Select a stitch pattern or alphabet.
- > Touch the icon «i»-Dialog.

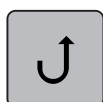

- > Touch the icon «Permanent reverse sewing» to sew permanently in reverse.
  - The machine keeps sewing in reverse until the icon «Permanent reverse sewing» is touched again.

## Backstepping

- > Select a stitch pattern or alphabet.
- > Touch the icon «i»-Dialog.



- > Touch the icon «Backstepping» to backstep the last 200 stitches.

## 5.6 Combining stitch patterns

### Overview Combi mode



- |   |  |   |  |
|---|--|---|--|
| 1 | Stitch width of the active stitch pattern  | 3 | Combi mode/Single mode                         |
| 2 | Stitch length of the active stitch pattern | 4 | Individual stitch pattern within a combination |

### Creating Stitch pattern combinations

In the Combi mode stitch patterns and alphabets can be combined according to your wish. By combining any alphabet letters, the logo BERNINA can be created.



- > Touch the icon «Single/Combi mode».
- > Select the desired stitch patterns.



- > Touch the icon «Single/Combi mode» again to return to the single mode.

### Saving a stitch pattern combination

- > Create a stitch pattern combination.
- > Touch the icon «Personal memory».



- > Touch the icon «Save stitch pattern».



- > Touch the icon «Confirm» or the yellow-framed icon to save the stitch pattern combination.

### Loading a stitch pattern combination

- > Touch the icon «Single/Combi mode».



- > Touch the icon «Personal memory».



- > > Touch the icon «Selection of stitch pattern combination».
- > Select a stitch pattern combination.

### Overwriting a stitch pattern combination

- > Create a stitch pattern combination.
- > Touch the icon «Personal memory».



- > Touch the icon «Save stitch pattern».
- > Select the stitch pattern combination which is to be overwritten.



- > Touch the icon «Confirm» to overwrite the stitch pattern combination.

### Deleting a stitch pattern combination

- > Create a stitch pattern combination.
- > Touch the icon «i»-Dialog.

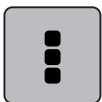

- > Touch the icon «Edit the whole combination».



- > Touch the icon «Delete».



- > Touch the icon «Confirm».

### Editing a single stitch pattern

- > Create a stitch pattern combination.
- > With the touchscreen pen/finger touch the desired position (1) within the stitch pattern combination to select a single stitch pattern.



- > Touch the icon «i»-Dialog to edit the single stitch pattern.

### Deleting a single stitch pattern

- > Create a stitch pattern combination.
- > With the touchscreen pen/finger touch the desired position (1) within the stitch pattern combination to select a single stitch pattern.



- > Touch the icon «i»-Dialog.



- > Touch the icon «Delete» to delete the individual stitch pattern  
or



- > touch the desired stitch pattern (1) with the touchscreen pen/finger, keep it touched and move it outwards.
  - The stitch pattern is deleted.



### Adding a single stitch pattern

The new stitch pattern is always inserted **after** the selected stitch pattern.

- > Create a stitch pattern combination.
- > With the touchscreen pen/finger touch the desired position (1) within the stitch pattern combination to select a single stitch pattern.



- > Select a new stitch pattern.

### Mirroring a stitch pattern combination

- > Create a stitch pattern combination.
- > Touch the icon «i»-Dialog.

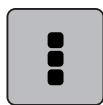

- > Touch the icon «Edit the whole combination».
- > Touch the icon «Mirror image left/right» to mirror the whole stitch pattern combination from the left to the right.
- > Touch the icon «Mirror image left/right» again to reset the alterations to default setting.

### Stitch pattern combination Subdivider 1

A stitch pattern combination can be subdivided into several sections. The subdivision is placed **beneath** the cursor. Only this section is sewn where the cursor is placed. To sew the next section, the cursor must be placed in the next section.

- > Create a stitch pattern combination.
- > With the touchscreen pen/finger select the desired position within the stitch pattern combination where the stitch pattern combination is to be subdivided.
- > Touch the icon «i»-Dialog.

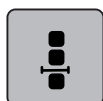

- > Touch the icon «Edit combination at cursor position».

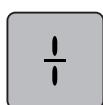

- > Touch the icon «Combination subdivider».

### Stitch pattern combination Subdivider 2

A stitch pattern combination can be interrupted at several positions. The interruption is placed **beneath** the cursor.

- > Create a stitch pattern combination.
- > With the touchscreen pen/finger select the desired position within the stitch pattern combination where the stitch pattern combination is to be interrupted.
- > Touch the icon «i»-Dialog.

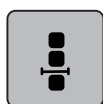

- > Touch the icon «Edit combination at cursor position».

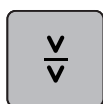

- > Touch the icon «Combination subdivider 2».
- > Sew the first section and then reposition the fabric.

### Securing a stitch pattern combination

- > Create a stitch pattern combination.
- > With the touchscreen pen/finger select the desired position within the stitch pattern combination where the stitch pattern combination is to be secured.
- > Touch the icon «i»-Dialog.

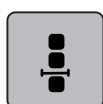

- > Touch the icon «Edit combination at cursor position».



- > Touch the icon «Securing».
  - Every single pattern of the stitch pattern combination can be secured at the start or at the end.

## Programming pattern repeat

- > Create a stitch pattern combination.
- > Touch the icon «i»-Dialog.



- > Touch the icon «Edit the complete combination».

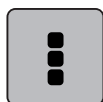

- > Touch the icon «Pattern repeat» once to repeat the stitch pattern combination.
- > Touch the icon «Pattern repeat» again to repeat the stitch pattern combination up to 9 times.
- > To deactivate the pattern repeat, keep the icon «Pattern repeat» pressed or touch the icon «clr».



## 5.7 Administering stitch patterns

### Saving settings of stitch patterns

- > Select a stitch pattern, alphabet or buttonhole.
- > Touch the icon «i»-Dialog.
- > Edit the stitch, alphabet or buttonhole.



- > Touch the icon «Saving stitch pattern settings» to save the alterations permanently.



- > Touch the icon «Back to default setting» to cancel the alterations.



### Saving stitch patterns in personal memory

In the filing system «Personal memory» any stitch patterns, also those which have been individually edited, can be saved.

- > Select a stitch pattern, alphabet or buttonhole.
- > Edit the stitch pattern.
- > Touch the icon «Personal memory».



- > Touch the icon «Save stitch pattern».
- > Select the file where the pattern is to be saved.
- > Touch the icon «Confirm».





### Overwriting stitch patterns from the personal memory

Prerequisite:

- The stitch pattern is saved in the personal memory.
- > Select a stitch pattern, alphabet or buttonhole.
- > Edit the stitch pattern.
- > Touch the icon «Personal memory».



-  > Touch the icon «Save stitch pattern».
- > Select the file where the stitch pattern to be overwritten has been saved.
- > Select the stitch pattern which should be overwritten.
-  > Touch the icon «Confirm».

### Loading stitch patterns from the personal memory

Prerequisite:

- The stitch pattern is saved in the personal memory.



- > Touch the icon «Personal memory».



- > Touch the icon «Load embroidery motif».
- > Select the file where the stitch pattern has been saved.
- > Select a stitch pattern.

### Deleting stitch patterns from the personal memory

Prerequisite:

- The stitch pattern is saved in the personal memory.



- > Touch the icon «Personal memory».



- > Touch the icon «Delete».
- > Select the file where the stitch pattern has been saved.
- > Select a stitch pattern.



- > Touch the icon «Confirm» to delete the stitch pattern.

### Saving stitch patterns on the BERNINA USB stick

On the BERNINA USB stick stitch patterns, also those which have been individually edited, can be saved.

- > Select a stitch pattern, alphabet or buttonhole.
- > Edit the stitch pattern.
- > Touch the icon «Personal memory».



- > Touch the icon «Save stitch pattern».
- > Insert the BERNINA USB stick into the USB port of the machine.



- > Touch the icon «USB Stick».



- > Touch the icon «Confirm».

### Uploading a stitch pattern from the BERNINA USB stick



- > Touch the icon «Personal memory».



- > Touch the icon «Load stitch pattern».

- > Touch the icon (1).

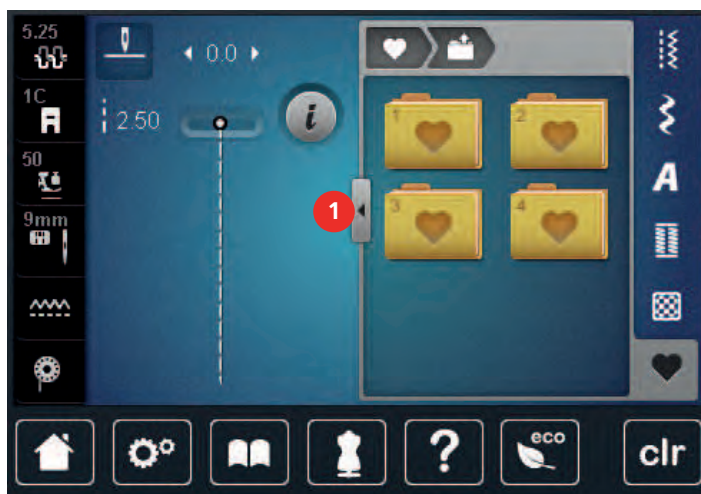

- > Insert the BERNINA USB stick into the USB port of the machine.
- > Touch the icon «USB stick».
- > Select the desired stitch pattern.

### Deleting stitch patterns from the BERNINA USB stick



- > Touch the icon «Personal memory».



- > Touch the icon «Delete».
- > Insert the BERNINA USB stick into the USB port of the machine.
- > Select the stitch pattern which is to be deleted.



- > Touch the icon «Confirm».

## 5.8 Securing

### Securing with the button «Pattern end»

The button «Pattern end» can be programmed with various functions.



- > Push the button «Pattern end» before sewing is started or while sewing.
  - While sewing, a stop icon indicates that the function is activated and the stitch pattern or the current combination of a stitch pattern will be secured at the end with the programmed number of stitches.

### Securing via the icon «Securing»

Every single pattern of a stitch pattern combination can be secured either at the beginning or at the end.



- > Touch the icon «i»-Dialog.



- > Touch the icon «Securing» before starting to sew.
  - The stitch pattern/stitch pattern combination is secured with 4 stitches at the beginning.
- > Touch the icon «Securing» while sewing.
  - The stitch pattern or the active stitch pattern of the stitch pattern combination is secured with 4 stitches at the end.

## 5.9 Height Compensation of uneven layers

If the presser foot is at an angle when sewing over a thick seam, the feed dog cannot grip the fabric and the sewing project cannot be sewn out properly.

- > Place 1 – 3 compensating plates as required from the back of the presser foot close to the needle to level the fabric layer.

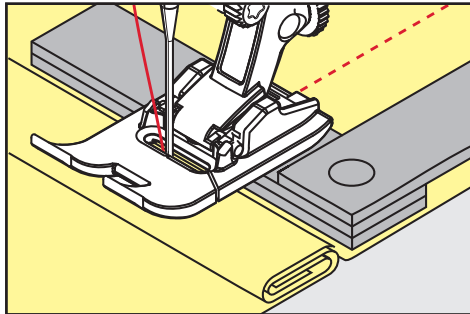

- The presser foot is leveled with the sewing project.

- > Place 1 – 3 compensating plates as required from the front of the presser foot close to the needle to level the fabric layer.

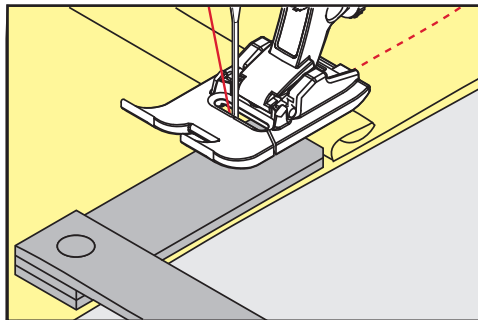

- The presser foot is leveled with the sewing project.

- > Sew until the complete presser foot has passed the thick seam.
- > Remove the plates of the height compensation.

## 5.10 Sewing Corners

When sewing corners, only a small section of the fabric is actually on the feed dog. Therefore it cannot grip the fabric well. By means of the height compensation tool the fabric can be fed evenly.

- > When the fabric edge is reached, stop the sewing process with needle position down.
- > Raise the presser foot.
- > Turn the fabric and place in desired position.
- > Place 1 – 3 compensating plates as required on the right of the presser foot close to the sewing project.
- > Lower the presser foot.

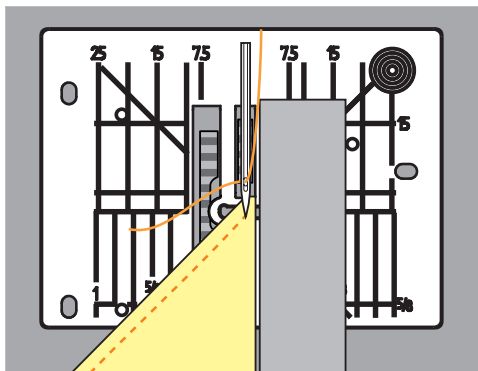







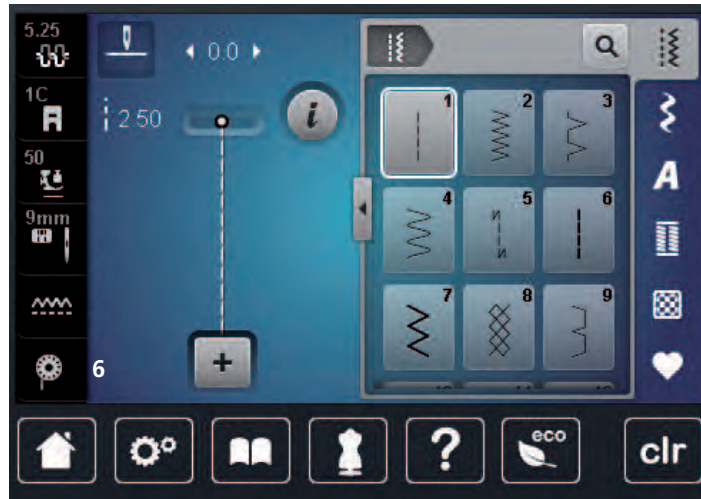



















- > Resume sewing until the sewing project is on the feed dog again.

## 6 Practical stitches





### 6.1 Overview Practical stitches



Stitch patterns	Stitch number	Name	Description
	1	Straight stitch	Seams and topstitching.
	2	Zig zag	Reinforcing seams, overcasting edges, sewing elastic seams and attaching lace.
	3	Vari overlock	Sewing and finishing in one step of elastic fabrics.
	4	Running stitch	Darning with running stitch, mending fabrics, reinforcing edges.
	5	Securing Program	Securing starts and ends of seams by straight stitching.
	6	Triple Straight stitch	Reinforced seams in heavy fabrics; visible hems and seams.
	7	Triple Zig zag	Reinforced seams in heavy fabrics; visible hems and seams.
	8	Honeycomb stitch	For stretch fabrics and hems. Is also used with elastic thread in the bobbin.
	9	Blindstitch	Blind hems, shell edging effect on soft jerseys and fine material, decorative seams.
	10	Double overlock	Sewing and finishing in one step of stretch fabrics.

Stitch patterns	Stitch number	Name	Description
	11	Superstretchstitch	For highly stretch fabrics. For all types of clothing.
	12	Gathering stitch	Most types of fabric; gathering with shirring elastic, butted seams = butting two pressed edges and sewing together, decorative stitches.
	13	Stretch overlock	Sewing and finishing in one step of stretch fabrics.
	14	Tricot stitch	Visible hems, visible seams in lingerie, sweaters, mending jersey.
	15	Universal stitch	For firm fabrics such as felt and leather. Flat joining seams, visible seams, attaching elastic, decorative seams.
	16	Sewn-out Zig zag	Edge finishing and reinforcing, attaching elastic, decorative seam.
	17	Lycra stitch	For lycra fabrics; flat joining seams and hems, reinforced seaming on underwear.
	18	Stretch stitch	For highly stretch fabrics; open seam for sportswear.
	19	Reinforced overlock	For medium-weight knitware and toweling; overlock seams, flat joining seams.
	20	Knit overlock	Sewing and finishing in one step of hand and machine knitted fabrics.
	21	Basting stitch	For seams and hems.
	22	Simple Darning Program	Darning of holes and damaged fabric.
	23	Reinforced Darning Program	Reinforcing darning holes and damaged fabric.
	24	Bartack Program	Reinforcing pocket openings, sewing belt loops.
	25	Bartack Program	Reinforcing pocket openings, sewing on belt loops, securing zippers and seam ends.
	26	Large Fly stitch	Reinforcing pocket openings, zippers and slits in medium-weight to thick fabrics.



Stitch patterns	Stitch number	Name	Description
	29	Narrow blindstitch	For blind hems in fine fabrics.
	31	Triple Straight stitch with long stitch	Reinforced seams in heavy fabrics; visible hems and seams.
	32	Single Straight stitch	Used as a connecting stitch in a combination.
	33	Three Single Straight stitches	As connecting stitches in a combination.

## 6.2 Sewing straight stitch

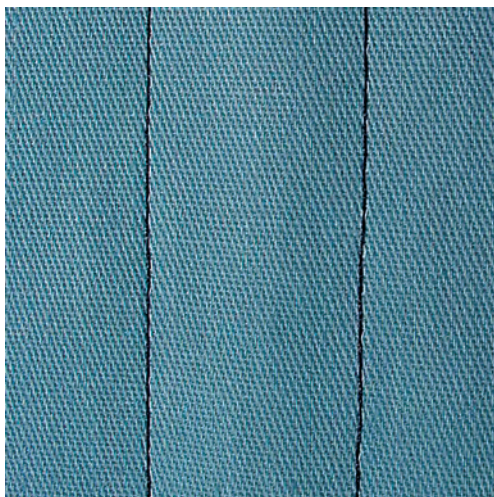

Match the stitch length with the sewing project, which means for denim fabrics long stitches (ca. 3 – 4 mm), for fine fabrics short stitches (ca. 2 – 2.5 mm). Match the stitch length with the thread size, e.g. long stitches when topstitching with Cordonnet (ca. 3 – 5 mm).

Prerequisite:

- The Reverse pattern foot No.1C/1D is attached.



- > Touch the icon «Practical stitches».
- > Select the Straight stitch No. 1.

### 6.3 Securing with the automatic Securing Program

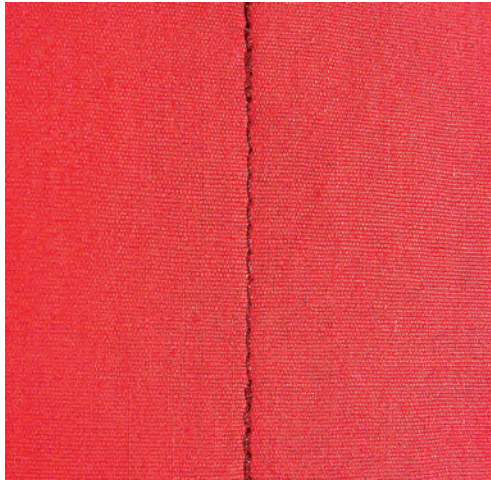

Due to a determined number of 5 stitches sewn forward and 5 stitches sewn backward, the securing is regular.

Prerequisite:

- The Reverse pattern foot No. 1C is attached.



- > Touch the icon «Practical stitches».
- > Select the Securing Program No. 5.
- > Press the foot control.
  - The machine secures automatically.

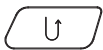

- > Sew the seam in the desired length.
- > Push the button «Quick reverse».
  - The machine secures automatically and stops at the end of the securing program.

### 6.4 Sewing in the zipper

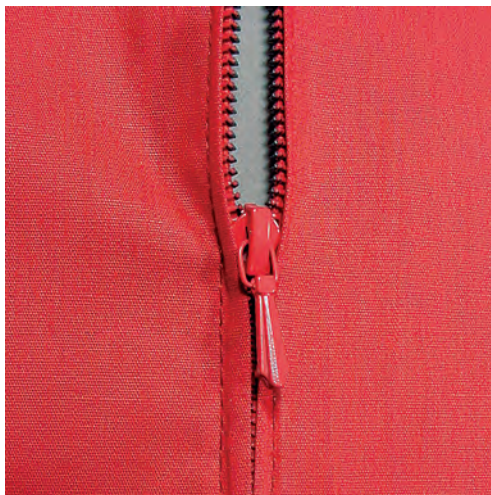

As the fabric feed can be difficult when starting to sew, it is recommended to hold the threads firmly or to pull the fabric slightly to the back for a few stitches or to sew 1 – 2 cm reverse first.

- > Attach the Reverse pattern foot No. 1C.



- > Touch the icon «Practical stitches».
- > Select the Straight stitch No. 1.
- > Sew the seam up to where the zipper starts.
- > Sew the securing stitches.
- > Close the zipper length with long stitches.
- > Finish the seam allowances.
- > Iron the seam.
- > Open the zipper length.
- > Baste the zipper under the fabric so that the fabric folded edges meet over the center of the zipper.
- > Open the zipper a few centimeters.
- > Attach the Zipper foot No. 4D.
- > Move the needle position to the right.
- > Use the Free Hand System to raise the presser foot and to position the sewing project.
- > Start sewing from top left.
- > Guide the foot so that the needle stitches along the zipper coils.
- > Stop in front of the zipper pull with needle position down.
- > Raise the presser foot.
- > Close the zipper.
- > Continue to sew and stop in front of the base of the zipper with needle position down.
- > Raise the presser foot and turn the sewing project.
- > Sew across the other side of the zipper and stop with needle position down.
- > Raise the presser foot and turn the sewing project.
- > Sew the second side from bottom to top.

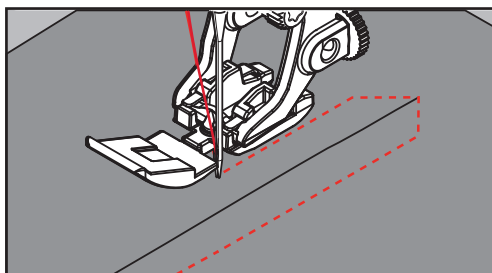

## 6.5 Sewing both sides of the zipper from bottom to top

For fabrics with pile, such as velvet, it is recommended to sew in the zipper on both sides from bottom to top.



When the fabric is densely woven or hard, it is recommended to use a needle with the size 90 – 100. This results in an even stitch formation.



- > Attach the Reverse pattern foot No. 1C.
- > Touch the icon «Practical stitches».
- > Select the Straight stitch No. 1.
- > Sew the seam up to where the zipper starts.
- > Sew the securing stitches.
- > Close the zipper length with long stitches.
- > Finish the seam allowances.
- > Iron the seam.
- > Open the zipper length.
- > Baste the zipper under the fabric so that the fabric folded edges meet over the center of the zipper.
- > Attach the Zipper foot No. 4D.
- > Move the needle position to the right.
- > Use the Free Hand System to raise the presser foot and to position the sewing project.

- > Start sewing in the center of the seam at the end of the zipper.
- > Sew diagonally along the edge of the zipper coils.
- > Sew the first side (1) from bottom to top.
- > Stop in front of the zipper pull with needle position down.
- > Raise the presser foot.
- > Open the zipper as far as behind the presser foot.
- > Lower the presser foot and continue sewing.
- > Sew the second side (2) in exactly the same way from bottom to top.

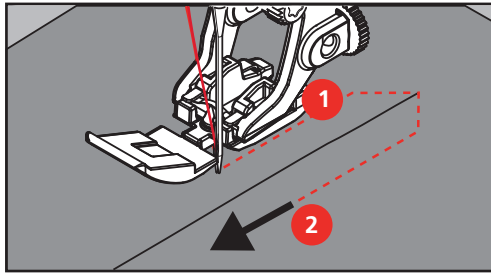

## 6.6 Sewing Triple straight stitch



The triple straight stitch is especially suitable for durable seams and for firm, densely woven fabrics such as denim and corduroy. For firm or densely woven materials it is recommended to attach the Jeans foot No. 8. This will help to sew denim or canvas. For decorative topstitching the stitch length can be elongated.

- > Attach the Reverse pattern foot No. 1C/1D.
- > Touch the icon «Practical stitches».
- > Select the Triple straight stitch No. 6.



## 6.7 Sewing Triple zig zag

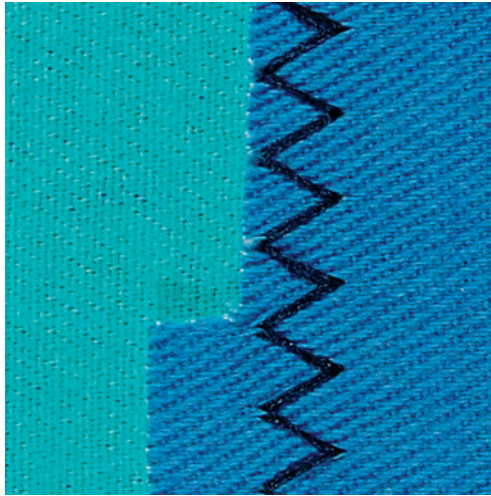

For firm materials such as denim, deckchair covers, awnings or frequently washed items. Finish raw edges first.



- > Attach the Reverse pattern foot No. 1C/1D.
- > Touch the icon «Practical stitches».
- > Select the Triple zig zag No. 7.

## 6.8 Manual darning

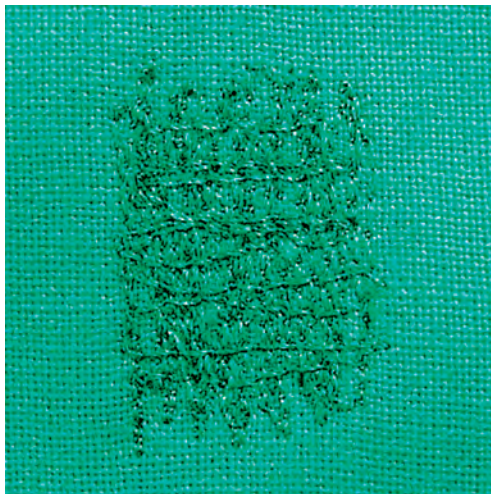

Used for darning holes or worn areas in all fabric types.

If the thread is lying on top and a poor stitch formation results, slow down the movement of the sewing project. If there are knots on the wrong side of the fabric, move the sewing project faster. When the thread breaks, guide the sewing project more consistently.



- > Attach the Darning foot No. 9 (optional accessory).
- > Touch the icon «Practical stitches».
- > Select the Straight stitch No. 1.
- > Lower the feed dog.
- > Attach the slide-on table.
- > Hoop the sewing project in the round embroidery hoop (optional accessory).
  - The area to be darned stays evenly taut and cannot be distorted.

- > Sew from the left to the right, guide the fabric evenly by hand without using pressure.
- > Move in curves when changing the direction to avoid holes and thread breakage.
- > Work the rows in irregular lengths so that the thread is better spread over the fabric.

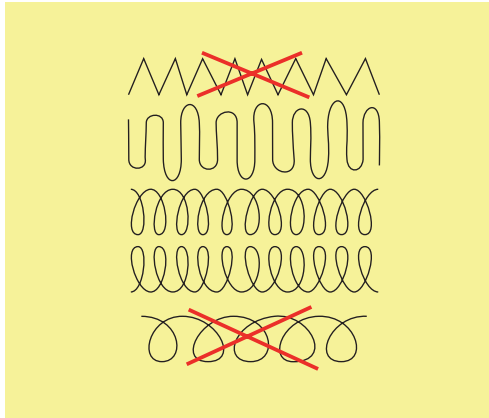

- > Sew the first rows not too close together and beyond the worn area.
- > Sew the rows in irregular lengths.

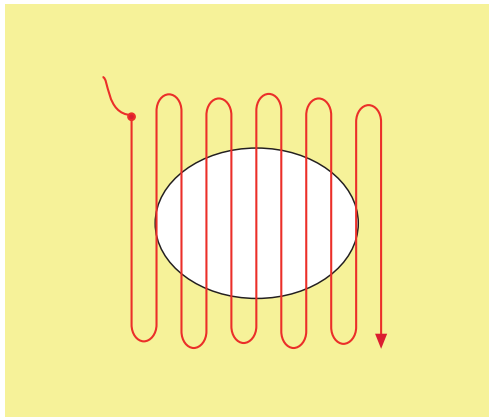

- > Turn the sewing project by 90°.
- > Sew the first rows not too close.

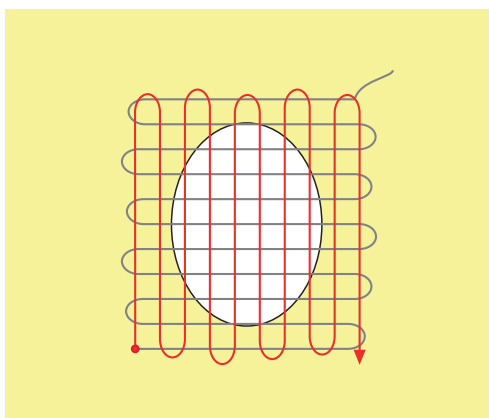

- > Turn the sewing project by 180°.

- > Sew another loose row.

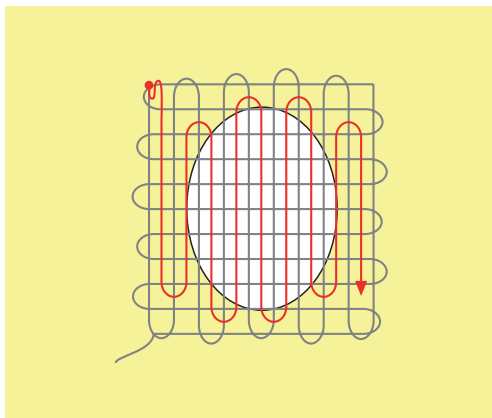

## 6.9 Automatic darning



The simple Darning Program No. 22 is especially suitable for quick darning of worn or damaged areas. It is recommended to use fine material as a backing for the worn and damaged areas or to stick an adhesive interlining. The simple Darning Program No. 22 replaces threads along the lengthwise grain in all materials. If the darning area becomes distorted, correct with the balance.

- > Attach the Reverse pattern foot No. 1C or the Buttonhole foot No. 3A.
- > Touch the icon «Practical stitches».
- > Select the simple Darning Program No. 22.
- > Hoop light-weight materials in the round embroidery hoop (optional accessory).
  - The darning area stays evenly taut and cannot be distorted.
- > Start sewing top left.
- > Sew the first row.
- > Stop the machine.
- > Push the button «Quick reverse».
  - The length is programmed.
- > Finish sewing the Darning Program.
  - The machine stops automatically.

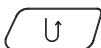

## 6.10 Reinforced darning, automatic



The reinforced Darning Program No. 23 is especially suitable for quick darning of thin areas or snags. The reinforced Darning Program No. 23 replaces longitudinal threads in all fabrics.



If the Darning Program does not cover the whole worn or damaged area, it is recommended to reposition the work and sew the Darning Program again. The length is programmed and can be repeated as often as desired.



- > Attach the Buttonhole foot No. 3A.
- > Touch the icon «Practical stitches».
- > Select the reinforced Darning Program No. 23.
- > Hoop light-weight materials in the round embroidery hoop (optional accessory).
  - The darning area stays evenly taut and cannot be distorted.

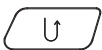

- > Start sewing top left.
- > Sew the first row.
- > Stop the machine.
- > Push the button «Quick reverse».
  - The darning length is programmed.
- > Finish sewing the Darning Program.
  - The machine stops automatically.

## 6.11 Finishing edges







### 6.13 Narrow edgestitching

- > Attach the Blindstitch foot No. 5 (optional accessory) or the Reverse pattern foot No. 1C or the Edge stitch foot No. 10/10C/10D (optional accessory).
- > Touch the icon «Practical stitches».
- > Select the Straight stitch No. 1.
- > Place the edge on the left against the guide of the Blindstitch foot.
- > Select the needle position left at the desired distance to the edge.

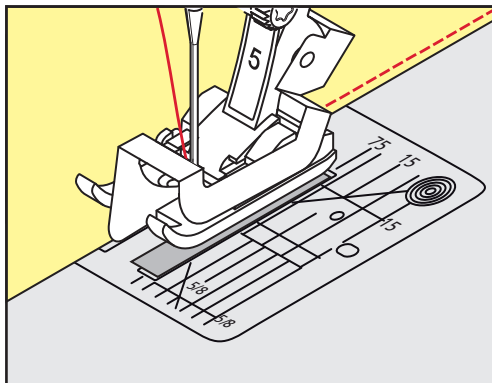

### 6.14 Wide edgestitching

- > Attach the Blindstitch foot No. 5 (optional accessory) or the Reverse pattern foot No. 1C or the Edge stitch foot No. 10/10C/10D (optional accessory).
- > Touch the icon «Practical stitches».
- > Select the Straight stitch No. 1.
- > Guide the edge along the presser foot or at a distance of 1 – 2.5 cm along the marks on the stitch plate.
- > Select the needle position at the desired distance to the edge.

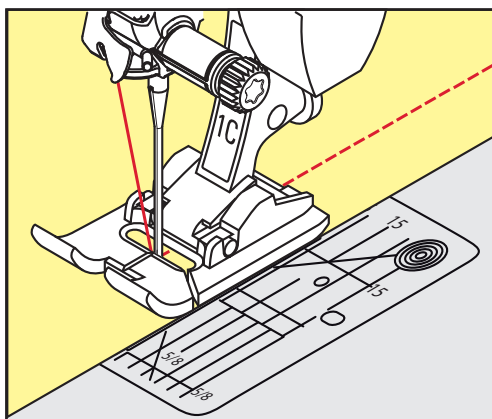

### 6.15 Edgestitching using the seam guide

When sewing parallel wider lines, it is recommended to guide the seam guide along the sewn of lines.

- > Attach the Reverse pattern foot No. 1C or the Edge stitch foot No. 10/10C/10D (optional accessory).
- > Touch the icon «Practical stitches».
- > Select the Straight stitch No. 1.
- > Loosen the screw on the back of the presser foot.
- > Insert the seam guide into the hole of the presser foot.
- > Adjust the width as desired.
- > Tighten the screw.



- > Guide the folded edge along the seam guide.

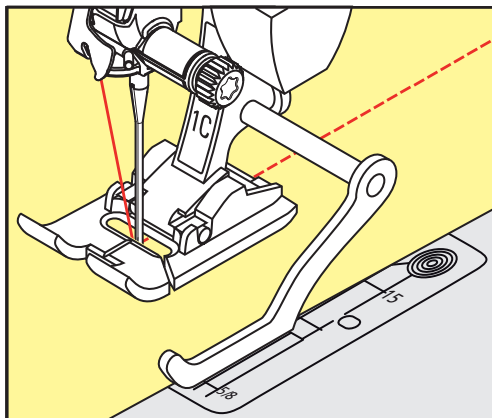

## 6.16 Sewing hem edges

When using the Blindstitch foot No. 5, it is recommended to select a needle position far left or far right. When using the Reverse pattern foot No. 1C or the Edge stitch foot No. 10/10C/10D, all needle positions are possible.

- > Attach the Blindstitch foot No. 5 (optional accessory) or the Reverse pattern foot No. 1C or the Edge stitch foot No. 10/10C/10D (optional accessory).
- > Touch the icon «Practical stitches».
- > Select the Straight stitch No. 1.
- > Place the inside upper edge right against the guide of the Blindstitch foot.
- > Select the needle position far right to sew along the upper edge.

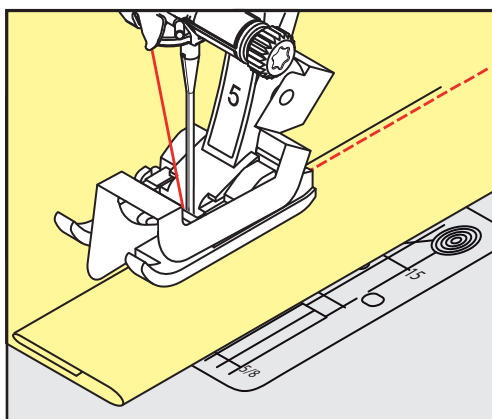

## 6.17 Sewing blind hems

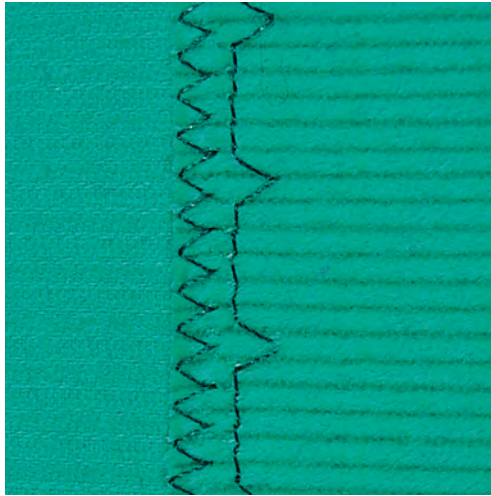

For invisible hems in medium to heavy weight cotton, wool and blended materials.

Prerequisite:

- The raw edges are finished.
- > Attach the Blindstitch foot No. 5 (optional accessory).
- > Touch the icon «Practical stitches».
- > Select the Blindstitch No. 9.
- > Fold the fabric back over the right side of the fabric to expose the finished lower edge.
- > Place the fabric under the presser foot and move the folded edge against the metal guide on the presser foot.
- > Guide the folded edge evenly along the metal guide of the foot to sew the stitches evenly deep.
  - Make sure that the needle only pierces the edge of the fold.
- > Check the blind hem on both fabric sides again after about 10 cm and adjust the stitch width if necessary.

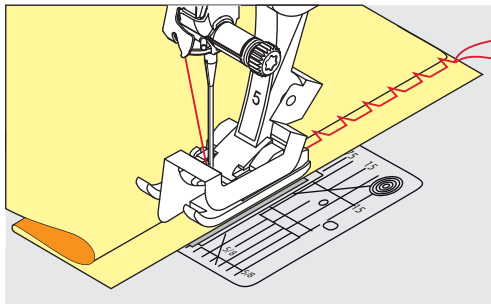

## 6.18 Sewing visible hems

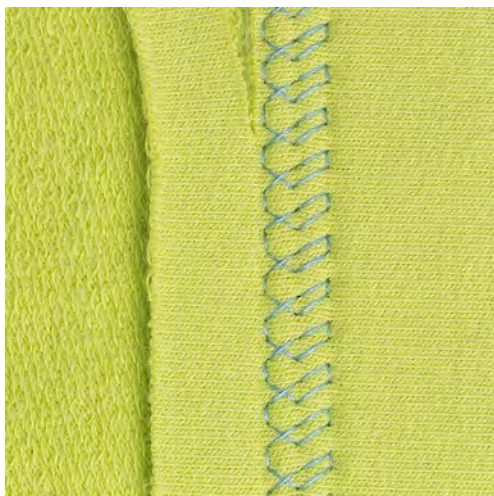

The visible hem is especially suitable for elastic hems in jersey, cotton, wool, synthetic and mixed fibers.



- > Attach the Reverse pattern foot No. 1C/1D.
- > Touch the icon «Practical stitches».
- > Select Tricot stitch No. 14.
- > Iron the hem and baste if necessary.
- > Reduce the presser foot pressure if necessary.
- > Sew the hem at the preferred depth on the right side.
- > Trim the excess fabric from the wrong side.

## 6.19 Sewing flat joining seams

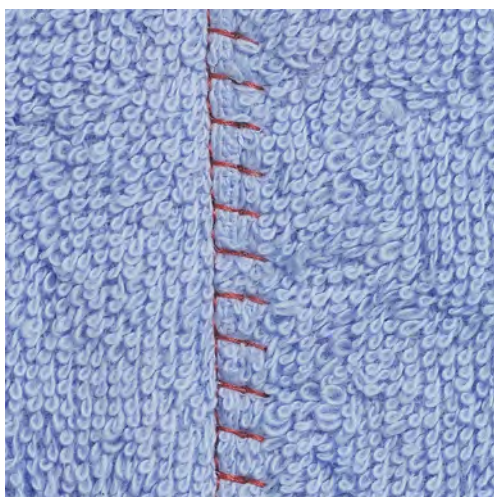

The flat joining seam is especially suitable for or thick materials such as terry cloth, felt and leather.



- > Attach the Reverse pattern foot No. 1C.
- > Touch the icon «Practical stitches».
- > Select the Stretch overlock No. 13.
- > Overlap the fabric edges.
- > Sew along the fabric edge.
- > The needle stitches over the edge of the top layer on the right side into the bottom layer to get a very flat durable seam.

## 6.20 Sewing basting stitches

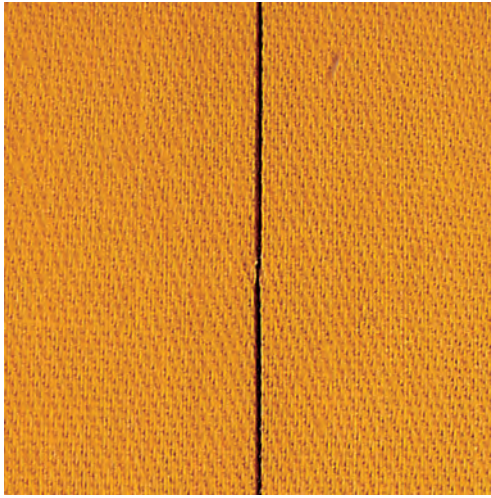

When sewing basting stitches, it is recommended to use a fine darning thread as this is easier to remove. With the Basting stitch No. 21 only every fourth stitch is sewn. The longest stitch possible is 24 mm when the stitch length is set at 6 mm. The recommended stitch length is 3.5 – 5 mm. The basting stitch is suitable for sewing projects where a very long stitch length is required.



- > Attach the Reverse pattern foot No. 1C/1D.
- > Touch the icon «Practical stitches».
- > Select the Basting stitch No. 21.
- > Select the stitch length.
- > Pin the fabric layers at a right angle to basting direction to prevent the layers from slipping.
- > Sew 3 – 4 basting stitches at the beginning and at the end.

## 7 Decorative stitches

### 7.1 Overview Decorative Stitches

simple or more complex decorative stitches should be selected to best suit the material.

- Decorative stitches which are programmed with simple straight stitches are particularly appropriate for light-weight materials, e.g. the Decorative stitch No. 101.
- Decorative stitches which are programmed with triple straight stitches or with a few satin stitches are particularly appropriate for medium-weight materials, e.g. Decorative stitch No. 107.
- Decorative stitches which are programmed with satin stitches are particularly appropriate for heavy-weight materials, e.g. Decorative stitch No. 401.

For a perfect stitch formation it is of advantage to use the same thread color for upper and bobbin thread and a stabilizer. With pile or longfiber materials, it is recommended to use an additional, water-soluble stabilizer on the right side, which can be easily removed after sewing.



Decorative stitch	Category	Name
	Category 100	Natural stitches
	Category 300	Cross stitches
	Category 400	Satin stitches
	Category 600	Ornamental stitches
	Category 700	Heirloom stitches
	Category 900	Novelty

## 7.2 Bobbin-Play



The bobbin can be filled with different thread material. For free-motion stitching to add texture. This method is similar to «normal» free-motion sewing, but is done on the **wrong** side of the fabric.

Reinforce the area to be sewn with embroidery stabilizer. The design can be drawn on the wrong side of the fabric. You can also draw the design on the front side of the fabric. The lines can be followed with a freely guided straight stitch using polyester, cotton or rayon thread. The rows of stitching are visible on the right side of the fabric, and serve as reference lines for the bobbin-thread sewing.

The BSR function can be used for bobbin-thread sewing. It is recommended to guide your project at consistent speed evenly under the needle, following the lines of the design. The stabilizer must be removed after sewing.

Sew a sample first to check what the result looks like on the wrong side of the fabric.

Not all decorative stitches are suitable for this technique. Simple decorative stitches provide best results. Avoid compact stitch types and satin stitches.

### NOTICE

Inappropriate bobbin case is used

Damage of the bobbin case.

> Use the Bobbinwork bobbin (optional accessory).



> Attach the Embroidery foot No. 20C or No. 20D (optional accessory).

> Touch the icon «Decorative stitches».

> Select an appropriate decorative stitch.

> Turn the «Upper Multifunctional knob» and the «Lower Multifunctional knob» to adjust the stitch length and the stitch width so that even when sewing with thick thread a nice stitch formation can be achieved.

> Touch the icon «i»-Dialog.



> Touch the icon «Long stitch» so that the stitch pattern is sewn less densely.

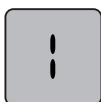

> Touch the icon «Upper thread tension» to adjust the upper thread tension if necessary.





### 7.3 Altering the stitch density

With certain decorative stitches (e. g. No. 401) the stitch density can be altered. If the stitch density is increased, the stitch distance is enlarged. If the stitch density is decreased, the stitch distance is shortened. The programmed length of the stitch pattern is not affected.

- > Select the decorative stitch.
- > Touch the icon «i»-Dialog.



- > Touch the icon «Edit pattern length/stitch density».
- > Adjust the stitch density via the icons (1) «-» or «+».



### 7.4 Sewing cross stitches

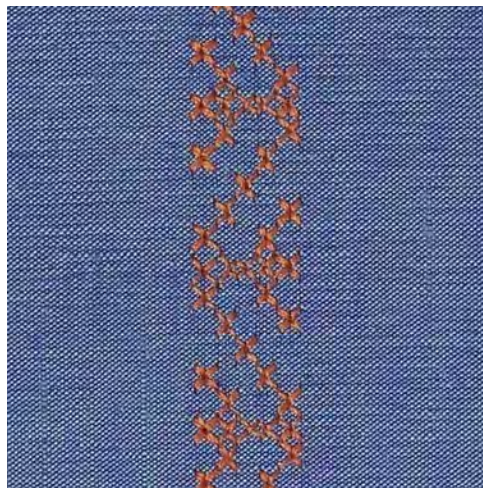

Cross stitching is a traditional technique, and extends the range of decorative stitches. If the cross stitches are sewn on fabric with a linen texture, they look like hand-stitched cross stitching. When cross stitches are sewn with cotton embroidery thread, the stitch pattern appears fuller. Cross stitches are particularly used for home furnishing, trimmings on garments and embellishing in general. As every following line refers to the first row, it is important to stitch the first row in a straight line.

- > Attach the Reverse pattern foot No. 1C/1D or the Open Embroidery foot No. 20C or the Embroidery foot No. 20D (optional accessory).
- > Select a cross stitch of the Category 300 and combine it as desired.
- > Stitch the first row using the seam guide or slide-on table seam guide to sew a straight line.
- > Stitch the second row next to the first at a distance of one presser foot's width or using the seam guide.





## 7.5 Pintucks

### Pintucks

The technique reduces the size of the fabric piece. It is always advisable to plan in sufficient fabric. Pintucks are narrow stitched folds, which are normally sewn on the fabric before cutting out the pieces for the garment or the sewing project. They are suitable for embellishing or in combination with other heirloom embroidery techniques.

A more distinctive and relief-like effect can be achieved when the pintucks are corded, which means that they are sewn with an additional pintuck cord. Choose a pintuck cord that fits well into the grooves of the selected pintuck foot. The cord must be colorfast and shrink-proof.

### Overview pintucks

Pintuck foot	Number	Description
	# 30 (optional accessory)	3 grooves For heavy-weight fabrics. In combination with the 4 mm double needle
	# 31 (optional accessory)	5 grooves For heavy to medium-weight fabrics. In combination with the 3 mm double needle
	# 32 (optional accessory)	7 grooves For light to medium-weight fabrics. In combination with the 2 mm double needle
	# 33 (optional accessory)	9 grooves For very light fabrics (without pintuck cord). In combination with the 1 or 1.6 mm double needle
	# 46C (optional accessory)	5 grooves In combination with the 1.6 – 2.5 mm double needle For very light to medium-weight fabrics.

## Inserting the cord

- > Switch the machine off and disconnect it from the power supply system.
- > Remove the needle.
- > Remove the presser foot.
- > Remove the stitch plate.
- > Open the bobbin cover.
- > Pull the cord through the hook opening from the bottom and through the opening of the stitch plate.
- > Replace the stitch plate.
- > Close the bobbin cover.
- > Make sure that the cord slides through the thread slot of the bobbin cover.

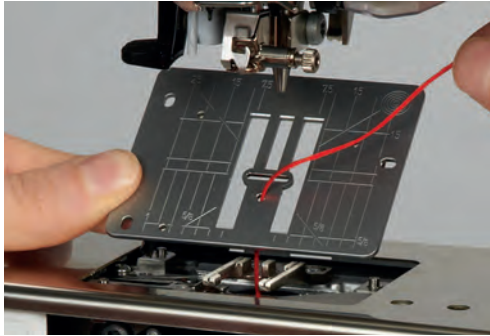

- > Place the cord spool on the knee lifter.



- > Check that the cord runs smoothly.
- > If the thread doesn't glide smoothly at the hook cover, leave the hook cover open.
- > If the hook cover is opened, deactivate the lower thread indicator in the Setup Program.

## Sewing Pintucks

The cord lies on the wrong side of the material and is held/sewn over by the bobbin thread.

- > Sewing the first pintuck.
- > Place the first pintuck in one of the side grooves in the presser foot.
- > Sew additional pintucks parallel.

## 8 Alphabets

### 8.1 Overview Alphabet

Block, Double block, Script and Quilt alphabets as well as Cyrillic can be sewn in two different sizes. Block, Double block, Script and Quilt alphabets as well as Cyrillic can also be sewn in lower case letters.

For a perfect stitch formation it is recommended to use the same thread color for upper and bobbin threads. The fabric can be reinforced with embroidery stabilizer on the wrong side. Use an additional, water-soluble stabilizer on the right side of pile or napped fabrics.

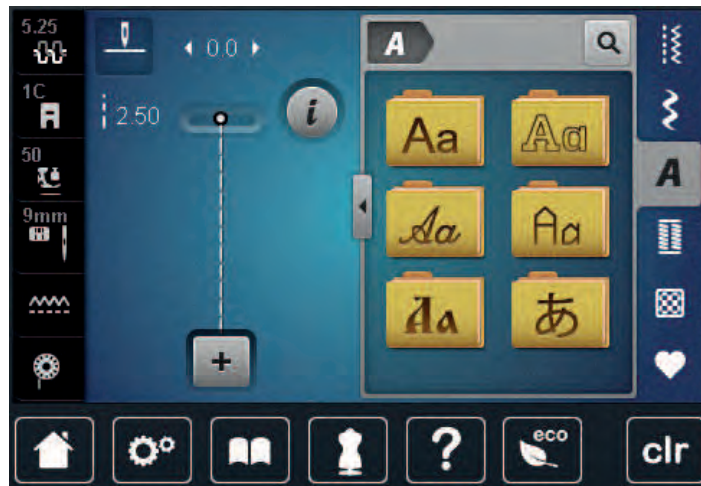

Stitch patterns	Name
ABCabc	Block alphabet
ABCabc	Double-Block
<i>ABCabc</i>	Script (Italics)
ABCabc	Quilt alphabet
АБВабв	Cyrillic
あいう	Hiragana

### 8.2 Creating lettering



It is recommend to sew a test sample using the desired thread, the original fabric and the original stabilizer. Please make sure that the fabric is fed evenly and lightly without colloding and being caught. Do not pull, push or hold the fabric while sewing.



- > Touch the icon «Alphabets».
- > Select the font.

- > Touch the icon «Single/Combi mode» to create a combination.
- > Touch the icon «Display alphabets» (1) to open an extended enter mode.



- > Select the letters.
- > Touch the icon (2) (standard setting) to use upper case letters.
- > Touch the icon (3) to use lower case letters.
- > Touch the icon (4) to use figures.
- > Touch the icon (5) to use special characters and mathematical symbols.



- > Touch the icon «DEL» to delete single letters of the entered text.
- > Touch the icon «Display alphabets» again to close the extended enter mode.

### 8.3 Altering font size

Block, Double block, Script and Quilt alphabets as well as Cyrillic can also be downsized.



- > Select the icon «Alphabets».
- > Select the font.
- > Select the letters.



- > Touch the icon «i»-Dialog.

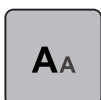

- > Touch the icon «Altering font size» to downsize the font size.
- > Touch the icon «Altering font size» again to scale up the font size up to 9 mm.





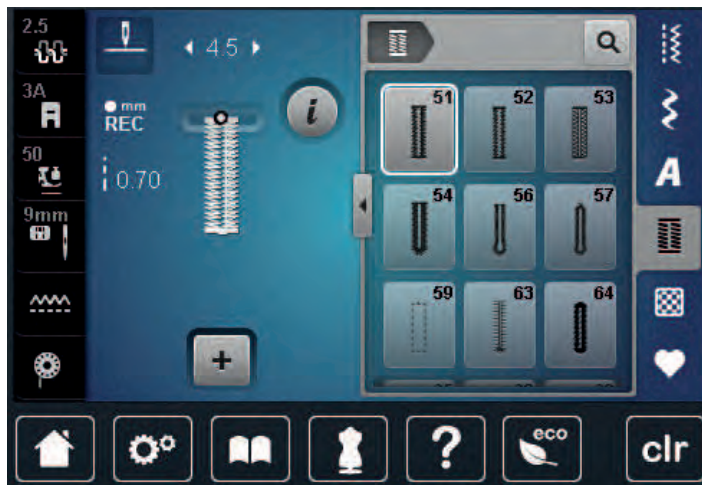

## 9 Buttonholes

### 9.1 Overview Buttonholes

To create the correct buttonhole for every button, every purpose and for every garment, your BERNINA 765 SE is equipped with a considerable collection of buttonholes. The corresponding button can be sewn on automatically. Eyelets can also be sewn.



Buttonhole	Buttonhole number	Name	Description
	51	Standard buttonhole	For light to medium-weight fabrics; blouses, dresses, bedlinens.
	52	Standard buttonhole narrow	For light to medium-weight fabrics; blouses, dresses, children's and baby clothes, crafts.
	53	Stretch buttonhole	For any highly elastic jersey made from cotton, wool, silk and synthetic fibers.
	54	Round buttonhole with normal bartack	For medium to heavy-weight fabrics; dresses, jackets, coats, rainwear.
	56	Keyhole buttonhole	For heavy-weight, non-stretch fabrics; jackets, coats, leisure wear.
	57	Keyhole buttonhole with pointed bartack	For firm, non-stretch fabrics: jackets, coats, leisure wear.
	59	Straight stitch buttonhole	Program for staystitching buttonholes, for pocket openings, reinforcing buttonholes, especially for buttonholes in leather and imitation leather.
	63	Heirloom	For light to medium-weight woven fabrics; blouses, dresses, leisure wear, bedlinens.

Buttonhole	Buttonhole number	Name	Description
	64	Double-rounded buttonhole	For medium to heavy-weight fabrics made of various material.
	65	Double-rounded Heirloom	For light to medium-weight woven fabrics; blouses, dresses, bedlinen.
	69	Decorative buttonhole with double pointed bartack	For decorative buttonholes in firmer, non-elastic fabrics.
	60	Button sew-on program	For buttons with 2 and 4 holes.
	61	Eyelet with small zig zag	Openings for cords and narrow ribbons, for decorative work.
	62	Straight-stitch eyelet	Openings for cords and narrow ribbons, for decorative work.

## 9.2 Making use of the height compensation tool

When a buttonhole is to be sewn at right angles to the project edge, it is recommend to use the height compensation plates (optional accessory).

- > Place the plates from the back between the sewing project and the bottom of the slide to the thick part of the sewing project.

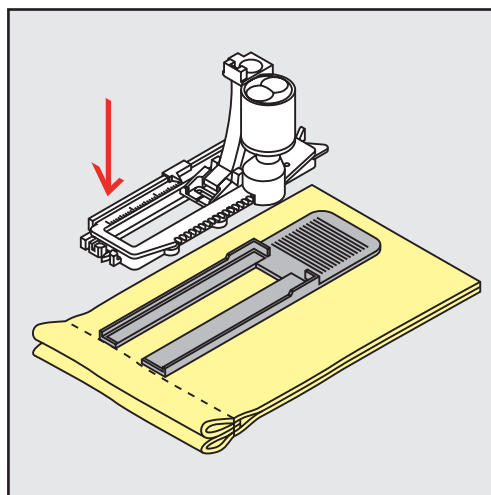

- > Lower the presser foot.

### 9.3 Using the compensation plate

When sewing a buttonhole in difficult materials, it is recommended to use the compensation plate for buttonholes (optional accessory). It can be used along with the Buttonhole foot No. 3A.

- > Insert the compensation plate carefully from the side.

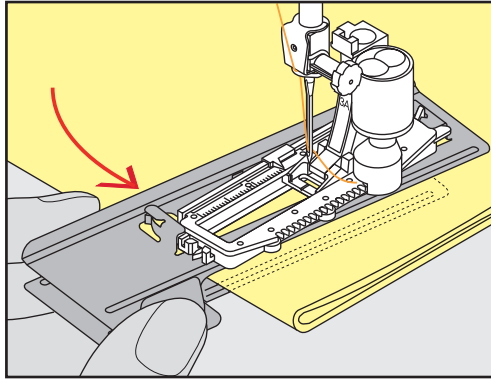

### 9.4 Marking buttonholes

- > For the buttonholes to be sewn manually, mark the position and the length on the fabric using chalk or a water-soluble pen.

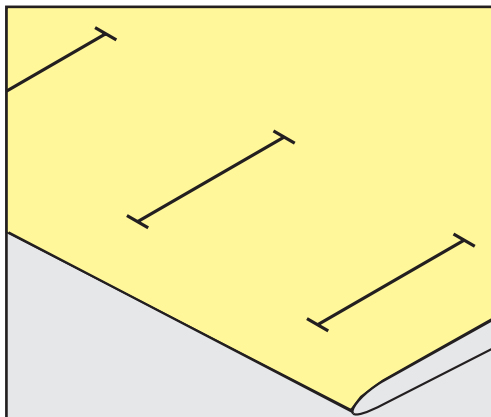

- > For the buttonholes to be sewn automatically, mark the complete length of 1 buttonhole on the fabric using chalk or a water-soluble pen. For any subsequent buttonholes mark the starting point.

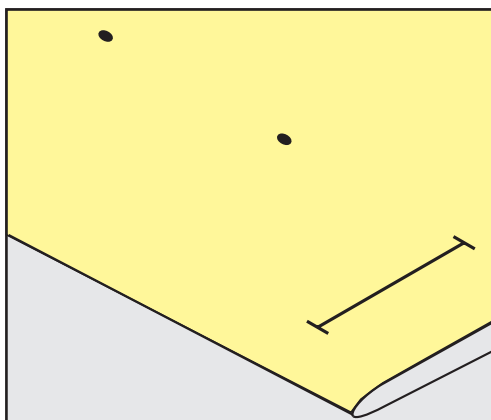



- > For keyhole and round buttonholes mark the length of the bead with chalk or a water-soluble pen on the fabric. For any subsequent buttonholes mark the starting point. The length of the keyhole is sewn additionally.

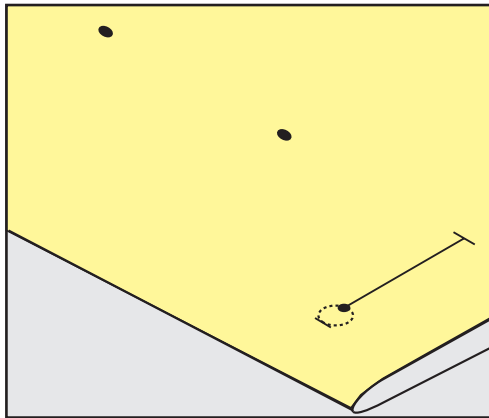

## 9.5 Cord

### Using cord with the Buttonhole foot with slide No. 3A

Cords reinforce buttonholes and enhance their appearance and suit best for the Buttonhole No. 51. Ideal cords are Perle cotton No. 8, strong hand-sewing thread and fine crochet yarn. It is recommended to not hold the cord while sewing.

Prerequisite:

- The Buttonhole foot with slide No. 3A is attached and raised.
- > Insert the needle at the beginning of the buttonhole.
- > Guide the cord on the right side under the buttonhole foot.
- > Hook the cord over the pin at the back of the buttonhole foot.

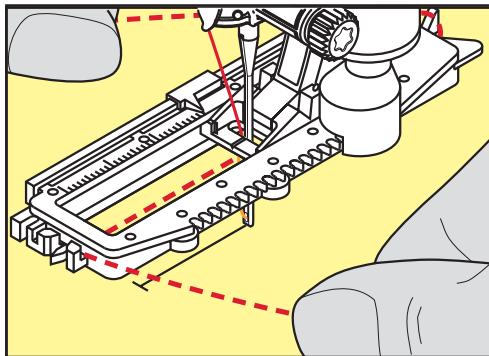

- > Pull the cord on the left side under the buttonhole foot to the front.

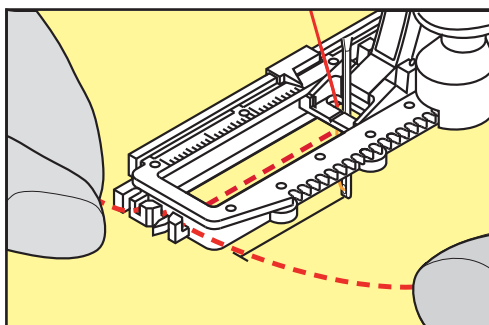

- > Pull the cord ends into the slits.
- > Lower the buttonhole foot.
- > Sew the buttonhole in the usual manner.
- > Pull the cord through the buttonhole until the loop disappears in the bartack.
- > Pull the ends of the cord through to the wrong side of the fabric (using a hand stitching-needle), knot or secure with stitches.

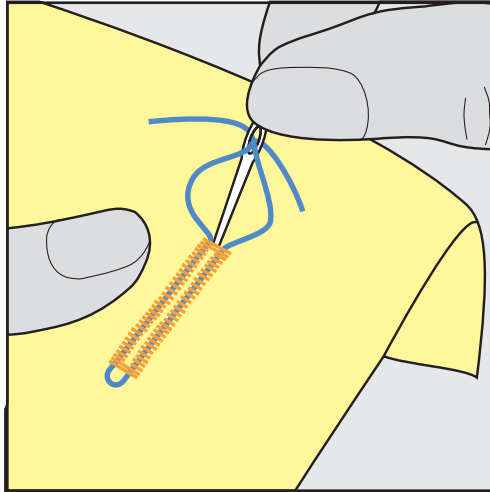

### Using cord with the Buttonhole foot No. 3C (optional accessory)

Prerequisite:

- The Buttonhole foot No. 3 is attached and raised.
- > Insert the needle at the beginning of the buttonhole.
- > Hook the cord over the pin at the front of the buttonhole foot.

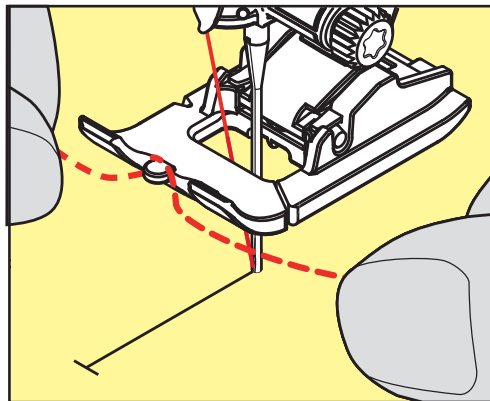

- > Pull both cords ends under the buttonhole foot to the back and place each a cord into a groove of the sole.

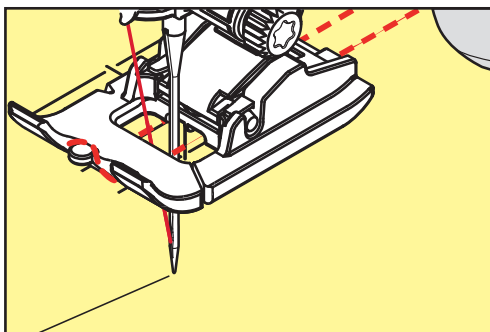

- > Lower the buttonhole foot.
- > Sew the buttonhole in the usual manner.
- > Pull the cord through the buttonhole until the loop disappears in the bartack.
- > Pull the ends of the cord through to the wrong side of the fabric using a hand stitching-needle and knot or secure with stitches.

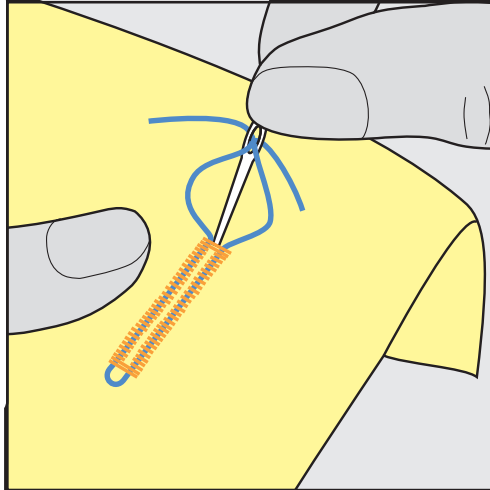

## 9.6 Sewing a test sample

Always sew a test sample of the buttonhole on the same fabric: It is recommended to use the same stabilizer and to select the same buttonhole. The test sample should also be sewn in the respective direction. By sewing a test sample the settings can be adjusted until the sewing result is satisfying.

When working with soft loosely woven materials or for buttonholes which are highly stressed, it is worth underlaying the buttonholes with the Straight stitch buttonhole No. 59. This is also recommended to reinforce buttonholes in leather, vinyl or felt.

Alterations of the balance when sewing a manual standard buttonhole as well as the keyhole and the round buttonhole affect both beads in the same way. With the manual keyhole or round buttonhole, the alterations affect both sides in the opposite way.

If the stitch counter function is used and alterations are made concerning the balance, the alterations affect both buttonhole beads differently.



- > Touch the icon «Buttonholes».
- > Select the buttonhole.
- > Select and attach the desired presser foot.
- > Place the fabric under the presser foot and lower the presser foot.
- > Press the foot control carefully and start sewing. Guide the fabric slightly.
- > Check the balance while sewing and adjust if necessary.
- > Check the test sample and make further amendments if necessary.

## 9.7 Determining the buttonhole slit width

The width of the buttonhole slit can be adjusted between 0.1 – 2.0 mm before sewing.



- > Touch the icon «Buttonholes».
- > Select the buttonhole.



- > Touch the icon «i»-Dialog.

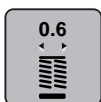

- > Touch the icon «Buttonhole slit width».
- > Turn the «Upper Multifunctional knob» or the «Lower Multifunctional knob» to adjust the buttonhole slit width as desired.

## 9.8 Determining the buttonhole length via the Buttonhole foot with slide No. 3A



The button can be placed in the yellow circle in the left section of the display. The yellow circle can be enlarged or downsized by turning the «Upper/Lower Multifunction knobs» and the diameter of the button can be determined in this way.

Additionally to the diameter of the button, 2 mm are added automatically for the buttonhole length. If the diameter of the button is 14 mm, the buttonhole length is calculated 16 mm.

Prerequisite:

- The Buttonhole foot with slide No. 3A is attached.



- > Touch the icon «Buttonholes».
- > Select the buttonhole.



- > Touch the icon «i»-Dialog.



- > Touch the icon «Adjust the buttonhole length».
- > Turn the «Upper Multifunctional knob» or the «Lower Multifunctional knob» to adjust the buttonhole length.

## 9.9 Determining the buttonhole length with Buttonhole foot No. 3C (optional accessory)

With the Buttonhole foot No. 3C (optional accessory) the buttonhole length must be determined via the stitch counter function. The stitch counter function is suitable for all types of buttonholes. The left buttonhole bead is sewn forward, the right buttonhole bead is sewn in reverse. If alterations of the balance are made, the stitch counter function has to be saved for every buttonhole separately.

Prerequisite:

- The Buttonhole foot No. 3C (optional accessory) is attached.



- > Touch the icon «Buttonholes».
- > Select the buttonhole.



> Touch the icon «i»-Dialog.



> Touch the icon «Program the length with the stitch counter».

> Sew the desired buttonhole length.

> Stop the machine.

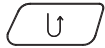

> Push the button «Quick reverse» so that the machine sews the lower bartack and the second bead in reverse.

> Stop the machine at the height of the first stitch.

> Push the button «Quick Reverse» so that the machine sews the upper bartack and the securing stitches.  
– The length of the buttonhole remains saved and every subsequent buttonhole is sewn identically until the machine is switched off.

## 9.10 Sewing a buttonhole automatically

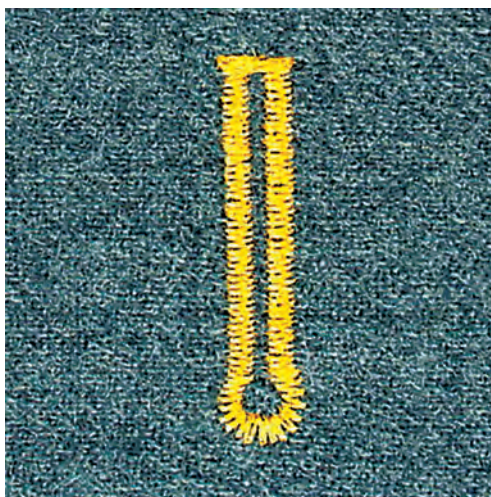
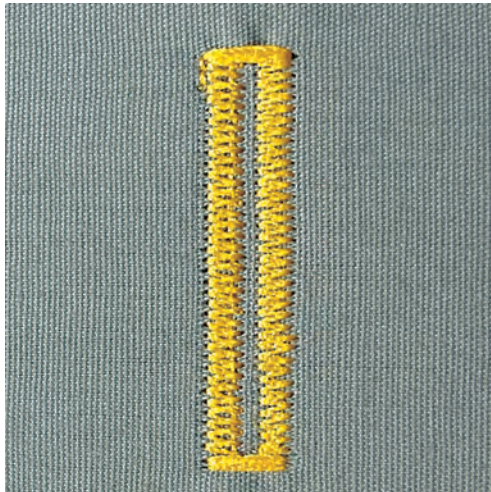

When the Buttonhole foot with slide No. 3A is used, the length of the buttonhole is measured automatically by the lens on the presser foot. The buttonhole will be duplicated and the machine switches to the next step automatically when the maximum length is reached. The Buttonhole foot with slide No. 3A is suitable for buttonholes in the length of 4 – 31 mm, depending on the buttonhole type. The slide of the Buttonhole foot must lie perfectly flat on the fabric so that the length can be measured accurately. All the programmed buttonholes are the same length and of the same nice look.

Prerequisite:

- The Buttonhole foot No. 3A is attached.



- > Touch the icon «Buttonholes».
- > Select the Buttonhole No. 51 – 53 or 54, 56, 57 or No. 64, 65 or 69.
- > Sew the desired buttonhole length.

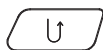

- > Press the button «Quick reverse» to program the length.



- > Press the button «Start/Stop» or the foot control.
  - The machine finishes the buttonhole automatically. All subsequent buttonholes are sewn at the same length.

### 9.11 Programming the Heirloom buttonhole

Prerequisite:

- The Buttonhole foot with slide No. 3A is attached.



- > Touch the icon «Buttonholes».
- > Select the Buttonhole No. 63.
- > Sew the desired buttonhole length.

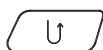

- > Push the button «Quick reverse» to program the length.
  - The machine finishes the buttonhole automatically. All subsequent buttonholes are sewn at the same length.

### 9.12 Sewing the manual 7-step buttonhole with the Buttonhole foot No. 3C (optional accessory)

The length of the buttonhole is determined manually when sewing. Bartack, eye and securing stitches are preprogrammed. The individual steps can also be selected by scrolling using the arrow icons or by touching the button «Quick Reverse».

Prerequisite:

- The Buttonhole foot No. 3C (optional accessory) is attached.



- > Touch the icon «Buttonholes».
- > Select the Buttonhole No. 51.



- > Touch the icon «i»-Dialog.



- > Touch the icon «Adjust the length manually».
  - Step 1 the display is activated for the buttonhole start.

- > Sew the desired buttonhole length.
  - Step 2 is activated.



- > Stop the machine at the desired length of the bead or at the end of the length marking.
- > Touch the icon «Scroll down» so that step 3 appears.
  - The machine sews straight stitches in reverse.
- > Stop at the height of the first stitch at the start of the buttonhole.
- > Touch the icon «Scroll down» so that step 4 appears.
  - The machine sews the upper bartack and stops automatically.
- > Touch the icon «Scroll down» so that step 5 appears.
  - The machine sews the second bead.
- > Stop the machine at the height of the first bead.
- > Touch the icon «Scroll down» so that step 6 appears.
  - The machine sews the bottom bartack and stops automatically.
- > Touch the icon «Scroll down» so that step 7 appears.
  - The machine secures and stops automatically.

### 9.13 Sewing the manual 5-step buttonhole with the Buttonhole foot No. 3C (optional accessory)

The length of the buttonhole is determined manually when sewing. Bartack, eye and securing stitches are preprogrammed. The individual steps can also be selected by scrolling using the arrow icons or by touching the button «Quick Reverse».

Prerequisite:

- The Buttonhole foot No. 3C (optional accessory) is attached.



- > Touch the icon «Buttonholes».
- > Select the Buttonhole No. 54.



- > Touch the icon «i»-Dialog.



- > Touch the icon «Adjust the length manually».
  - Step 1 the display is activated for the buttonhole start.

- > Sew the desired buttonhole length.
  - Step 2 is activated.



- > Stop sewing at the desired length of the bead or at the marking.
- > Touch the icon «Scroll down» so that step 3 appears.
- > The machine sews the eye or the keyhole and stops automatically.
- > Touch the icon «Scroll down» so that step 4 appears.
  - The machine sews the second bead in reverse.
- > Stop the machine at the first stitch where the buttonhole starts.
- > Touch the icon «Scroll down» so that step 5 appears.
  - The machine sews the upper bartack and secures automatically.

### 9.14 Cutting the buttonhole open with the seam ripper

- > Place a pin in each end of the buttonhole to avoid accidental cutting into ends of buttonhole.
- > Cut the buttonhole from both ends to the middle.

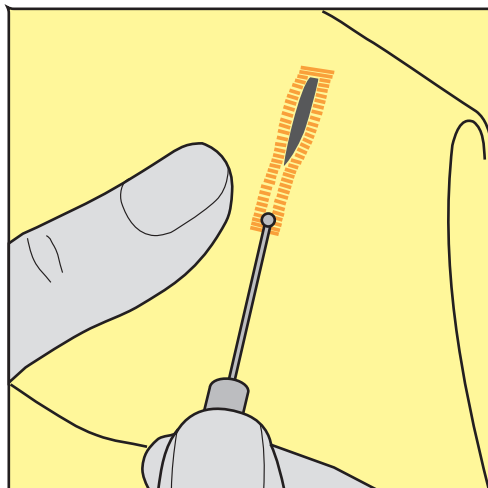



### 9.15 Cutting open buttonholes with the buttonhole cutter (optional accessory)

- > Place the fabric on an appropriate piece of wood.

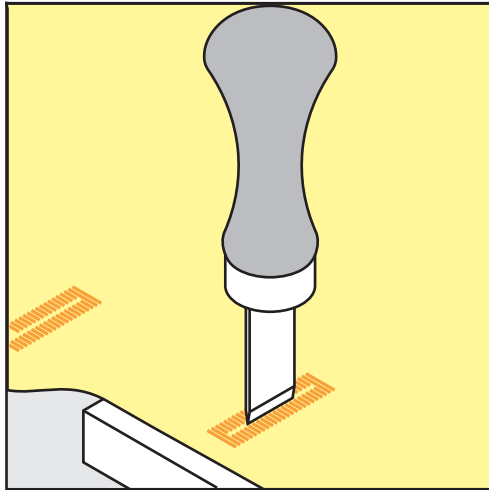

- > Position the cutter in the center of the buttonhole.
- > Press down on the cutter with your hand.

### 9.16 Sewing on buttons

With the Button sew-on program, buttons with 2 or 4 holes, snap buttons or snap fasteners can be sewn on.

Recommended sewing program: Button sewing-on program No. 60

Recommended presser foot : Button sew-on foot No. 18

Alternative presser feet:

- Reverse pattern foot No. 1 or 1C
- Darning foot No. 9
- Reverse pattern foot No. 34 or 34C

#### Adjusting the thread shank

For buttons on thicker fabrics, increase the thread shank = the distance between the button and the fabric. Buttons sewn on thin fabrics or buttons for decorative purposes only are stitched without a «thread shank».

**NOTICE! The adjustment of the thread shank is only possible when using the Button sew-on foot No. 18.**

- > Loosen the screw on the back of the presser foot.
- > Push the bar upwards according to the thickness of the fabric.
- > Tighten the screw.

#### Sewing on buttons

Prerequisite:

- The shank length is adjusted according the fabric thickness.
- The Button sew-on foot No. 18 or an alternative presser foot is attached.
- The attached presser foot has been selected in the user interface.
- The feed dog is lowered.



- > Touch the icon «Buttonholes».
- > Select the Button sew-on Program No. 60.
- > Turn the handwheel until the bobbin thread comes up.
- > **NOTICE! The Button sew-on program always starts above the left hole of the button.**  
Position the button on the fabric. Place the button and the fabric beneath the needle so that the needle stitches into the left hole.  
For buttons with 4 holes, sew the first front pair of holes first.
- > Lower the presser foot.
- > Perform the first stitches in the left hole via the handwheel.
- > Keep turning the handwheel until the needle changes to the right hole.  
Make sure that the needle meets the right hole. If necessary, adjust the stitch width by turning the upper Multifunction knob.
- > Hold the threads and push the foot control.
  - The machine sews on the button and stops automatically.
- > For increased stability, sew the Button sew-on program again.
- > Cut the threads with the machine. Alternatively, pull the sewing projects from under the sewing machine and trim the threads by hand. Pull the upper thread to the wrong side of the fabric and knot it with the bobbin thread.

## 9.17 Sewing eyelets



For increased stability sew the eyelet twice.

Prerequisite:

- The Reverse pattern foot No. 1C or the Open embroidery foot No. 20C is attached.







- > Touch the icon «Buttonholes».
- > Select the Eyelet Program No. 61 or No. 62.
- > Turn the «Upper Multifunctional knob» or the «Lower Multifunctional knob» to alter the size of the eyelet.
- > Sew the Eyelet Program.
  - The machine stops automatically at the end of the Eyelet Program.
- > Use an awl, punch pliers or a hole punch to open the eyelet.

## 10 Quilting

### 10.1 Overview Quilt Stitches



Stitch pattern	Number of stitch pattern	Name	Description
	1324	Quilting, Securing Program	To secure at the sewing start and sewing end with short stitches forward.
	1325	Quilting straight stitch	Straight stitch 3 mm stitch length, to join patchwork parts.
	1326	Piecing stitch/Straight stitch	Shorter straight stitch at 2 mm stitch length.
	1327	Stippling stitch	Imitation of stipple quilting.
	1328	Handlook quilt stitch	Imitation of handlook quilt stitch with monofilament.
	1329	Blanket stitch	For appliqué and sewing on ribbons.
	1330	Double blanket stitch	For appliqué and sewing on ribbons.
	1331	Blindstitch narrow	To sew blind stitches.
	1332	Feather stitch	For "Crazy Patchwork" and embellishing.
	1333	Feather stitch variations 1333 – 1338	For "Crazy Patchwork" and embellishing.

Stitch pattern	Number of stitch pattern	Name	Description
	1339	Decorative Quilt stitch variations 1339 – 1345, 1351, 1355 – 1370, 1388 – 1390, 1393, 1396 – 1398	For "Crazy Patchwork" and embellishing.
	1346	Quilt stitch/Handlook stitch variations 1346, 1347, 1348, 1350	Imitation of stipple quilting, to use with monofilament.
	1352	Blanket stitch dual	To edgestitch between two appliqués, "Crazy Patchwork".
	1353	Double blanket stitch dual	To edgestitch between two appliqués, "Crazy Patchwork".
	1354	Satin stitch	For appliqué.

## 10.2 Quilting, Securing Program

Prerequisite:

- The Reverse pattern foot No.1C is attached.



- > Touch the icon «Quilt stitches».
- > Select Quilt stitch pattern No. 1324.
- > Press the foot control.
  - The machine sews 6 stitches forward automatically when sewing is started.

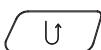

- > Sew the seam in the desired length.
- > Push the button «Quick reverse».
  - The machine sews 6 stitches forward automatically and stops automatically at the end of the Securing Program.

### 10.3 Sewing handlook quilt stitches

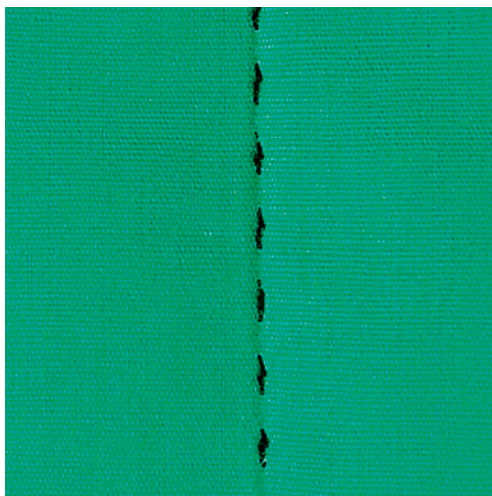

Handlook quilt stitches are suitable for all fabrics and sewing projects which should look hand sewn. It is recommended to use a monofilament thread as upper thread and an embroidery thread as bobbin thread. The sewing speed should be moderate to prevent the monofilament from breaking. If required, the upper thread tension and the balance can be adjusted to the sewing project and the desired quilt stitch.

Prerequisite:

- The Reverse pattern foot No. 1C is attached.



- > Touch the icon «Quilt stitches».
- > Select the Handlook quilt stitch No. 1328, 1346, 1347, 1348 or 1350.
- > If required, adjust the upper thread tension and the balance to the sewing project and the desired quilt stitch.
- > Press the foot control or the button «Start/Stop» to start the machine.

### 10.4 Guiding the quilt work freely

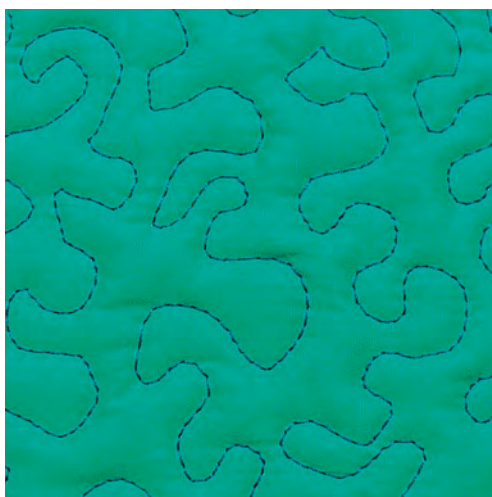

Quilt gloves with rubber fingertips (optional accessory) will help when guiding the fabric.

It is recommended to use the slide-on table and the Free Hand System. With free-motion quilting, it is of advantage to quilt from the center outwards and to guide the fabric using smooth, round movements to form the design of your choice. Free-motion quilting and darning are based on the same free-motion principles.

With stipple quilting, entire surfaces of the fabric are filled with quilt stitches. The single lines of stitching are rounded and never cross one another.

Prerequisite:

- The top layer, the batting and the backing are pinned together or basted.
- The feed dog is lowered.
- The Darning foot No. 9 (optional accessory) is attached.



- > Touch the icon «Practical stitches».
- > Select the Straight stitch No. 1.
- > Adjust the upper thread tension and the balance to the sewing project if necessary.
- > Press the foot control or the button «Start/Stop» to start the machine.
- > Hold both hands close to the presser foot like an embroidery hoop to guide the fabric.
- > If the thread is lying on top of the fabric, slow down the movement.
- > If there are knots on the wrong side of the fabric, move the fabric more quickly.

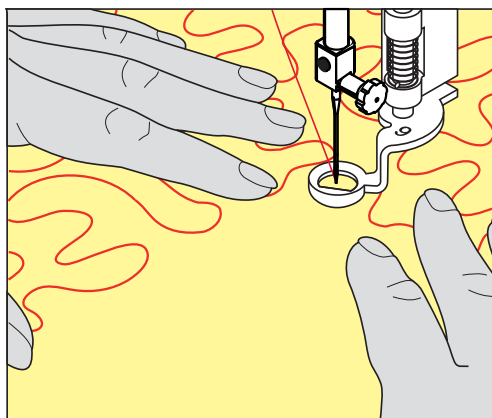

## 11 BERNINA Stitch Regulator (BSR)

The BERNINA Stitch regulator equalizes the stitch length which results of the free movement of the fabric while free-motion sewing - a sewing technique which grows more and more popular. When free-motion sewing with the BSR presser foot, every stitch is equally long and the stitch formation is perfectly regular.

As soon as the BSR presser foot is attached and the feed dog is lowered, the selection menu of the desired mode appears in the display of the machine. The BSR presser foot can be used with sewing straight stitch as well as zig zag.

The BSR presser foot reacts on the movement of the fabric and therefore controls the speed of the machine up to the highest possible speed. It can be said: The faster the movement of the material, the higher the speed of the machine.

If the fabric is moved too quickly, an acoustic signal sounds. The beeper can be activated or deactivated in the «BSR» display. The sound of the beeper can also be activated or deactivated in the Setup Program.

### 11.1 BSR mode 1

The BSR function can be controlled via the foot control or with the button «Start/Stop». Start the BSR mode. At the BSR presser foot a red light is on. By moving the fabric the machine accelerates. If the fabric isn't moved, securing in place is possible without pressing an additional button. When working via the foot control or when using the button «Start/Stop», the BSR mode doesn't stop automatically.

### 11.2 BSR mode 2

The BSR function can be controlled via the foot control or the button «Start/Stop». The machine starts only when the foot control or the button «Start/Stop» is pressed and the fabric is moved simultaneously. Without moving the fabric, the BSR2 modus stops after about 7 seconds. The red light goes off (only when working with the button «Start/Stop»). When working via the foot control, the red light doesn't go off.

### 11.3 BSR function with Straight stitch No. 1

This function allows free-motion quilting with straight stitch and a pre-programmed stitch length up to 4 mm. The programmed stitch length is maintained within a certain speed, independent of the fabric movement.

### 11.4 BSR function with Zig zag No. 2

The zig zag can be used e.g. for thread painting. The set stitch length will **not** be maintained when sewing the zig zag stitch, but the BSR function simplifies the application.

### 11.5 Sewing preparations for quilting

#### Attach the BSR presser foot

#### NOTICE

The lens of the BSR presser foot is dirty

The machine doesn't recognize the BSR presser foot.

> Clean the lens with a soft, slightly damp cloth.

> Change the presser foot.

- > Insert the cable of the BSR foot into the connection (1).

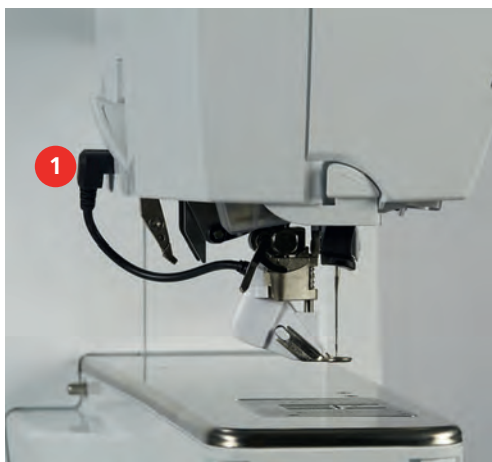

- > Switch the machine on.
  - The BSR display opens and the BSR 1 mode is activated.

### Changing the presser foot sole

**NOTICE**

The lens of the BSR presser foot is dirty

The machine doesn't recognize the BSR presser foot.

- > Clean the lens with a soft, slightly damp cloth.

The standard stitch length is 2 mm. When sewing small shapes and stippling it is recommended to shorten the stitch length to 1 – 1.5 mm.

- > Raise the needle.
- > Raise the BSR foot.
- > Switch the machine off and disconnect it from the power supply system.
- > Remove the BSR foot from the machine.
- > Press both push buttons at the BSR foot against each other.

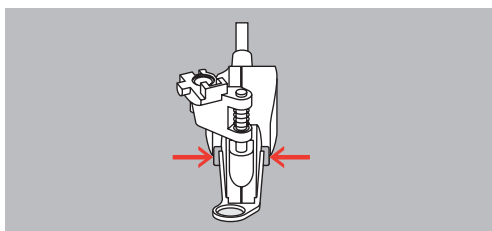

- > Pull the presser foot sole out of the guide downwards.
- > Insert the new presser foot sole into the guide and push upwards until it clicks into place.
- > Attach the BSR presser foot.

### 11.6 Using the BSR mode

The BSR function can be controlled via the foot control or the button «Start/Stop».

Starting via the foot control: The foot control needs to be pressed while quilting. The machine keeps running in the BSR1 mode until the foot control is released, even if the fabric isn't moved.

If quilting is stopped in the BSR2 mode, the machine sews another stitch depending on the needle position and stops with needle position up.





Prerequisite:

- The slide-on table is attached.
- The knee lifter of the Free Hand System is attached.

> Lower the feed dog.

> Select the desired BSR mode.



> Push the button «Start/Stop» or press the foot control to lower the presser foot.

> Push the button «Start/Stop» again or press the foot control again and keep pressed to start the BSR mode.

- At the BSR presser foot a red light is on.

> Move the fabric to control the speed of the machine in the BSR mode.



> Push the button «Start/Stop» again or release the foot control to stop the BSR mode.

- The BSR mode stops and the red light at the presser foot goes off.

> Touch the icon «BSR» (1) to deactivate the BSR mode and to quilt without automatic stitch length.

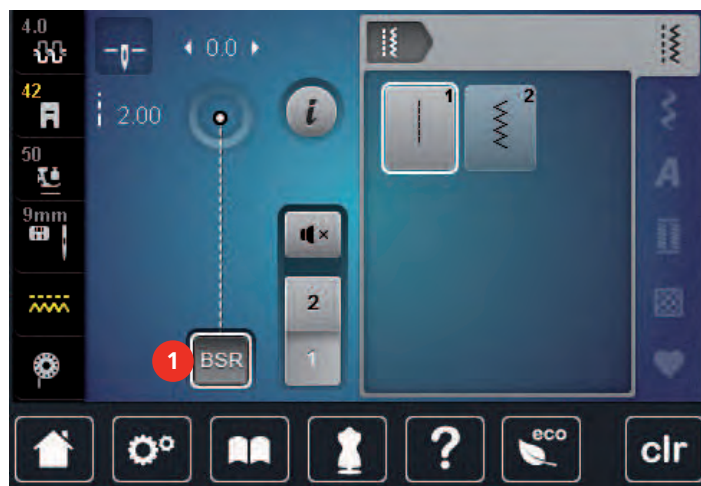

## 11.7 Securing

### Securing in BSR1 mode with the button «Start/Stop»

Prerequisite:

- The BSR presser foot is attached and connected with the machine.
- The BSR display is opened and the BSR1 mode is activated.

> Lower the feed dog.

> Lower the presser foot.



> Push the button «Needle up/down» twice.

- The bobbin thread is brought up.

> Hold the upper and the bobbin thread.



> Push the button «Start/Stop».

- Start the BSR mode.

> Sew 5 – 6 securing stitches.



> Push the button «Start/Stop».

- The BSR mode stops.

> Cut the thread.

## Securing in BSR2 mode

Prerequisite:

- The BSR presser foot is attached and connected with the machine.
- The BSR display is open and the BSR2 mode is activated.

- > Lower the presser foot.
- > Touch the icon «i»-Dialog.



- > Touch the icon «Securing».



- > Press the foot control or the button «Start/Stop».



By moving the fabric some short securing stitches are sewn, then the programmed stitch length is activated and the securing function is deactivated automatically.



## 12 My BERNINA Embroidery

### 12.1 Overview Embroidery module



- |   |   |   |                             |
|---|---|---|-----------------------------|
| 1 | Embroidery arm                            | 3 | Guide rails for the machine |
| 2 | Bracket for attaching the embroidery hoop | 4 | Connection to the machine   |

### 12.2 Supplied accessories Embroidery module

#### Overview accessory Embroidery module

**All rights reserved:** For technical reasons and for the purpose of product improvements, changes concerning the features of the machine can be made at any time and without advance notice. The supplied accessory can vary depending on the country of delivery.

Please visit [www.bernina.com](http://www.bernina.com) for more accessory information.









Illustration	Name	Purpose
	Embroidery foot # 26	For embroidering, darning and free-motion quilting.
	Large oval embroidery hoop	To embroider large embroidery motifs or motif combinations up to 145 x 255 mm (5.70 x 10.04 in).  Including the template for precise fabric positioning.

Illustration	Name	Purpose
	<p>Medium embroidery hoop</p>	<p>To embroider medium-sized embroidery motifs up to 100 x 130 mm (3.94 x 5.12 in).</p> <p>Including the template for precise fabric positioning.</p>
	<p>Small embroidery hoop</p>	<p>To embroider small embroidery motifs up to 72 x 50 mm (2.83 x 1.97 in).</p> <p>For free arm embroidering with closed sewing projects such as sleeves, trouser legs or socks.</p> <p>Including the template for precise fabric positioning.</p>
	<p>USB Connecting cable</p>	<p>To transfer data from the computer to the machine or vice versa.</p>
	<p>Embroidery needle assortment</p>	<p>For embroidering.</p>
	<p>Template holder</p>	<p>To place and remove the template in or out of the embroidery hoop.</p>
	<p>Net for upper thread spool</p>	<p>To support an even unwinding of the thread with slippery embroidery threads.</p>

## 12.3 Overview User Interface

### Overview functions/visual information



- |   |  |   |                               |
|---|--|---|-------------------------------|
| 1 | Upper thread tension                               | 4 | Stitch plate/Needle selection |
| 2 | Presser foot display/Presser foot selection        | 5 | Feed dog up/down              |
| 3 | Embroidery hoop selection /Embroidery hoop display | 6 | Fill level of bobbin thread   |

### Overview System settings



- |   |                     |   |                         |
|---|---------------------|---|-------------------------|
| 1 | Home                | 5 | Help                    |
| 2 | Setup Program       | 6 | eco mode                |
| 3 | Tutorial            | 7 | Back to default setting |
| 4 | Creative Consultant |   |                         |

## Overview Selection menu embroidery



- |   |                             |   |                   |
|---|-----------------------------|---|-------------------|
| 1 | Selection embroidery motifs | 3 | Color information |
| 2 | Editing embroidery motifs   | 4 | Embroidery        |

## 12.4 Important Embroidery information

### Upper thread

A good quality thread (brand manufacturer) is essential for embroidery so that the embroidery is not affected negatively because of poor thread or thread breakage.

Embroidery is particularly effective if you use 40wt glossy rayon or polyester embroidery threads as upper threads. They are available in a wide range of colors for beautiful embroidery.

- Glossy polyester with a brilliant sheen is a hard wearing, colorfast thread and has a high tensile strength which is suitable for all types of embroidery.
- Rayon is a soft viscose fiber with a brilliant sheen and suitable for fine, delicate embroidery, or items that will not receive excessive wear and tear.
- Metallic thread is a light to medium-weight thread suitable for special effects in embroidery.
- When working with metallic threads, the automatic bobbin thread cutter should be deactivated. The other thread cutters shouldn't be used either because the knives are likely to wear off very quickly.
- When using metallic threads, the speed and the upper thread tension should be reduced.



## Bobbin thread

In most cases black or white bobbin thread is used for embroidering. When both sides should have the same look, it is recommended to use the same color for bobbin and upper thread.

- Bobbin Fill is an especially soft and light polyester thread which is suited well to be used as bobbin thread. This special bobbin thread ensures a steady thread tension and an optimal intertwining of the upper and bobbin thread.
- Darning and embroidery threads are fine mercerized cotton threads which are suitable for embroidery on cotton.



## Choosing the embroidery motif

Simple motifs with a low stitch count are suitable for embroidery on fine material. Densely embroidered motifs, e. g. embroidered motifs with multiple color and embroidery direction changes, are suitable for medium and heavy-weight material.

## Selecting the embroidery file format

In order that embroidery motifs can be read by the BERNINA embroidery machine, they have to be created by the BERNINA Embroidery software and exported as .EXP file. Besides the actual embroidery file, a .BMP file and an .INF file are generated additionally. The .BMP file allows a preview of the embroidery motif and the .INF file provides the information on the thread colors. **Please note:** If the .INF file is missing, the embroidery motif cannot be displayed in the real color but only in standard colors. In this case, the colors can be entered manually in the color overview of the motif on the machine.

Additionally, following embroidery formats can be read by the machine: .PES, .PEC, .XXX, .PCS, .JEF and .DST. BERNINA International AG doesn't warrant that embroidery motifs which have not been created or converted by the BERNINA Embroidery software can be correctly read and embroidered.

Simple motifs with a low stitch count are suitable for embroidery on fine material. Densely embroidered motifs, e. g. embroidered motifs with multiple color and embroidery direction changes, are suitable for medium and heavy-weight material.

## Embroidery test

For the embroidery test, always use the original material reinforced with the same stabilizer as will be used later. For the embroidery test it is recommended to use the same colors, threads and needles which are planned to be used for the embroidery project.

## The size of the embroidery motif

Embroidery motifs can be enlarged or downsized on the embroidery machine or on the PC using the BERNINA Embroidery software (optional accessory). Enlargements or reductions up to 20% achieve the best results.





### Step stitch

Many short, equally long stitches are embroidered in offset rows closely next to each other which results in a densely filled area.

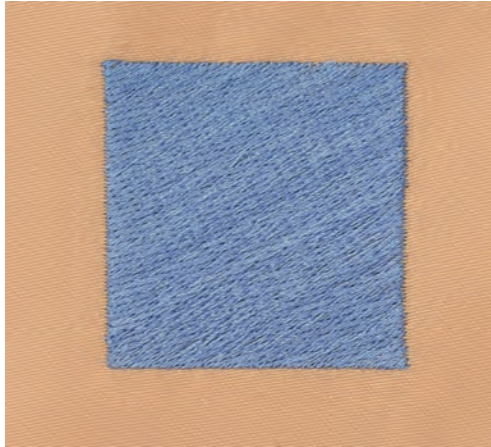

### Connecting stitches

Long stitches which are used to get from one part of the motif to the next. Before and after the connecting stitch securing stitches are sewn. Connecting stitches are trimmed.

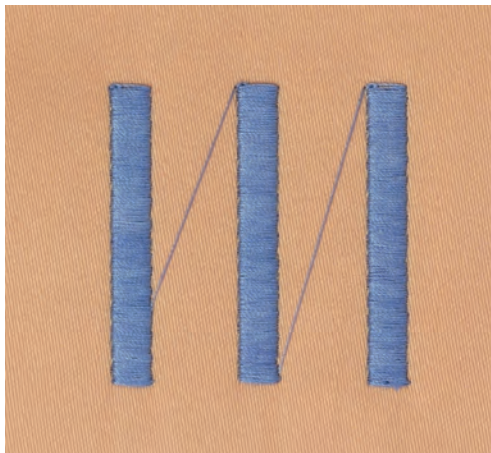

## 13 Embroidering preparation

### 13.1 Attaching the Module

**NOTICE**

#### Transporting the embroidery module

Damage to the embroidery module connection and machine.

- > Remove the embroidery module before transporting the machine.

Prerequisite:

- The slide-on table must not be attached.
  - > Make sure that the module and the machine are placed on a stable, even surface.
  - > Make sure that there is enough space around to allow the unimpeded movement of the embroidery arm.
  - > Lift the embroidery module on the left.
  - > Carefully push the embroidery module from left to right into the embroidery module connection of the machine (1).



- > To remove the embroidery module, lift it on the left side and pull it carefully to the left.

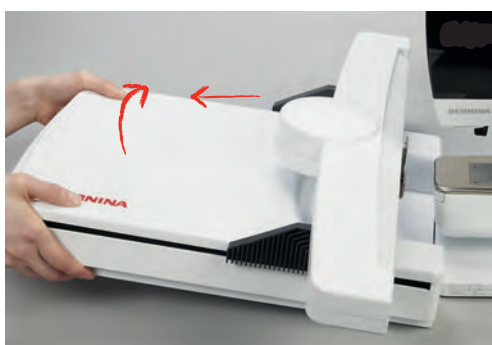

## 13.2 Preparing the machine

### Lowering the feed dog

- > Push the button «Feed dog up/down» to lower the feed dog.



- > Attach the stitch plate CutWork/Straight (see page 142).
- > Insert the needle (see page 140).
- > Attaching the embroidery foot (see page 139).

### Selecting an embroidery motif

All embroidery motifs can either be embroidered as-is or edited using the various functions offered by the embroidery machine. All embroidery motifs can be found in the attachment of this instruction manual. In addition to that, embroidery motifs can be loaded from the personal memory or from the BERNINA USB stick (optional accessory).



- > Touch the icon «Home».



- > Touch the icon «Embroidery mode».
- > Select an alphabet, embroidery motif or a personal embroidery motif from a file.



## 13.3 Embroidery foot

### Attaching the embroidery foot

- > Raise the needle.
- > Raise the presser foot.
- > Switch the machine off and disconnect it from the power supply system.

- > Push the clamping lever up.



- > Remove the presser foot.
- > Insert the embroidery foot from below into the bracket.
- > Press the clamping lever down.

### Selecting the presser foot in the User Interface

After having attached the respective embroidery foot (Embroidery foot No. 26, supplied accessory with the embroidery module), you can select and save it on the machine. Moreover, alternative feet are displayed which will also be suitable for the selected embroidery motif.

- > Switch the machine on.
- > Select the embroidery motif.
- > Touch the icon «Presser foot display/Presser foot selection».
- > Select the attached embroidery foot.



## 13.4 Needle and stitch plate

### Inserting the embroidery needle



Embroidery needles of the type 130/705 H-SUK provide a larger eye and are slightly rounded. This avoids thread abrasion when using Rayon- and cotton embroidery thread. Depending on the embroidery thread use a size No. 70-SUK to No. 90-SUK needle.

- > Raise the needle.
- > Switch the machine off and disconnect it from the power supply system.
- > Remove the attached foot.

- > Loosen the fixing screw of the needle using the screwdriver gray Torx.



- > Pull the needle down.
- > Hold the new needle with the flat side to the back.
- > Insert the needle as far as it will go.
- > Tighten the fixing screw of the needle using the screwdriver gray Torx.

### Selecting the embroidery needle in the User Interface

After having changed the needle, it can be checked whether or not it is suitable to be used together with the selected stitch plate.



- > Touch the icon «Needle/Stitch plate selection».
- > Select the attached needle.

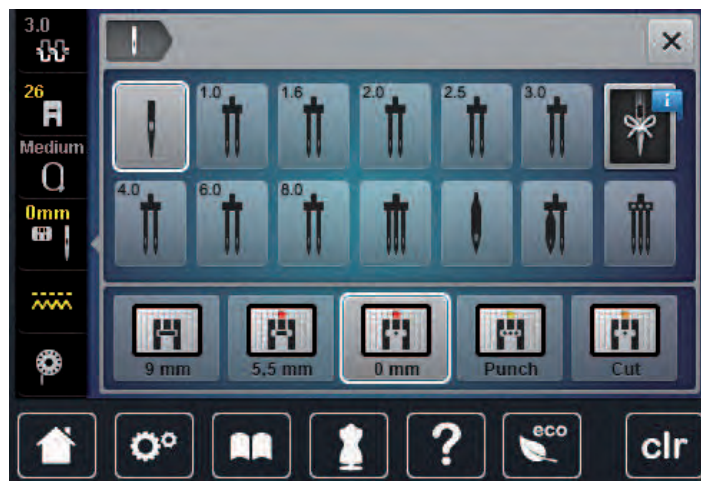

- If the selected needle is suitable in combination with the stitch plate, sewing can be started.
- If the selected needle is not suitable in combination with the stitch plate, starting the machine is automatically prevented.

### Selecting the needle type and the needle size

Convenient memory function: To prevent a loss of information, the needle type and the needle size can be saved additionally on the machine. The saved needle type and the saved needle size can be checked at any time.



- > Touch the icon «Stitch plate/Needle selection».

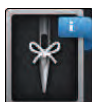

- > Touch the icon «Needle type/Needle size».
- > Select the needle type (1) of the inserted needle.

- > Select the needle size (2) of the inserted needle.



### Attaching the stitch plate

The stitch plate (CutWork/Straight, supplied accessory) has a small needle hole in the needle insertion area. The thread is pulled in and knotted optimally which results in an optimized stitching result.

- > Push the button «Feed dog up/down» to lower the feed dog.



- > Switch the machine off and disconnect it from the power supply system.
- > Remove the needle.
- > Remove the presser foot.
- > Press the stitch plate down at the mark back right until it flips up.



- > Remove the stitch plate.
- > Place the openings of the stitch plate (CutWork/Straight, supplied accessory) above the corresponding guide pins and press down until it clicks into place.

## Selecting the stitch plate in the User Interface

After having changed the stitch plate, it can be checked whether or not it is suitable to be used in combination with the selected needle.



- > Touch the icon «Stitch plate/Needle selection».
- > Select the stitch plate CutWork/Straight.



## Thread-up command

The machine must be ready for embroidery to bring up the bobbin thread. The bobbin thread can be brought up in one step for a manual knotting. If no securing stitches are wanted, it is recommended to deactivate the securing stitches in the Setup.



- > Hold the upper thread.
- > Press the button «Needle up/down».
  - The bobbin thread is brought up automatically.

## 13.5 Embroidery hoop

### Overview Embroidery hoop selection



- 1 Hoop selection

## Selecting the embroidery hoop

The best embroidery result is achieved when the smallest possible embroidery hoop for the embroidery motif is selected.

The embroidery motif has a pre-set size which is displayed.

Prerequisite:

- The embroidery motif is selected.
- > Touch the icon «Hoop selection».
- The machine selects the optimal embroidery hoop according to the size of the embroidery motif automatically. If the pre-set embroidery hoop would not be available, another desired embroidery hoop can be selected. When an embroidery hoop is attached which does not correspond with the selected one, the attached hoop is considered active and the embroidery motif area is displayed accordingly.
- > Select the desired embroidery hoop.



## Tear-away stabilizers

Using a stabilizer ensures more stability of the embroidery project. A tear-away stabilizer suits all woven and non-stretch materials. 1 – 2 layers can be used. Stabilizers are available in different weights. With larger embroidered areas the stabilizer will remain under the embroidery thread. The stabilizer is applied to the wrong side of the fabric with temporary adhesive spray. Carefully tear away excess stabilizer after embroidering.

## Cut-away stabilizers

Using a stabilizer ensure more stability of the embroidery project. A cut-away stabilizer suits all elastic materials. 1 – 2 layers can be used. Stabilizers are available in different weights. With larger areas to be embroidered the stabilizer will remain under the embroidery thread. The stabilizer is applied to the wrong side of the fabric with temporary adhesive spray. Carefully cut away excess stabilizer after embroidering.

## Using adhesive spray

The application of spray adhesive is recommended for stretch and smooth materials and knitware. It prevents the fabric from losing shape and slipping. Appliqués can be exactly positioned with spray adhesive. The spray adhesive shouldn't be used near the machine to avoid contamination.

- > Use the adhesive spray carefully at a distance 25 – 30 cm (9 – 12 inch) when spraying the stabilizer.
- > Adhere the sprayed stabilizer to the wrong side of the fabric carefully, smoothing material so there are no puckers.
- > Position smaller parts such as pocket flaps or collars on the stabilizer.
- > To avoid the possibility of getting hoop marks when working with napped materials or fleece, don't hoop the parts but spray the stabilizer and hoop it.
- > Adhere the fabric to be embroidered.
- > Remove any adhesive residue before starting the machine.

## Using spray starch

Spray starch is ideal for additional stiffening fine, loosely woven materials. Always use an additional stabilizer on the wrong side of the material.

- > Spray the area to be embroidered.
- > Let it dry or press gently with a warm iron if necessary.

## Using iron-on interfacing

Iron-on interfacings are available in a variety of weights. It is recommended to use an iron-on interfacing which is easily removable from the basic fabric. An Iron-on interfacing suits all materials that are easily distorted like stretch fabric such as tricot and jersey.

- > Iron-on interfacings are ironed to the wrong side of the material using a warm iron.



## Using paper-backed adhesive stabilizer

Paper-backed adhesive stabilizers are intended to be used for fabrics such as jersey and silk as well as for embroidery projects which are not suited to be hooped in the embroidery hoop.

- > Place the stabilizer in the hoop, so that the paper side is up.
- > Use a pair of scissors to score the paper and remove paper in the hoop area.
- > Position the fabric to be embroidered on the stabilizer and press it on place.
- > Remove any adhesive residue before starting the machine.

## Using water-soluble stabilizer



For lace embroidery it is recommended to hoop 1 – 3 layers of water-soluble stabilizer in the embroidery hoop. As the embroidery motif is not embroidered on the fabric, only the thread embroidered motif is left. The embroidery motifs should be combined with short stitches otherwise the individual motifs may fall out.

The stabilizer dissolves in water. Water-soluble stabilizers are an ideal protection for looped pile fabrics preventing the loops from being damaged! It prevents threads from sinking into the material and keeps the fabric pile from poking through the embroidery. Water-soluble stabilizers are ideal for fine, sheer fabrics where other stabilizers may show through the embroidery stitches as well as for lace embroidery.

- > Place the stabilizer on top of the material.
- > Place all the layers together into the embroidery hoop.
- > Use adhesive spray to adhere stabilizer if necessary.
- > For material with a pile, reinforce with additional, suitable stabilizer on the wrong side. In addition to that a water-soluble stabilizer can be placed on top of the material and fixed with basting stitches.
- > After dissolving, lay the motif down flat and let dry.

## Preparing the embroidery hoop

The embroidery hoop consists of an outer and an inner hoop. There is a corresponding template for every hoop. The area to be embroidered is marked in 1 cm (0.39 inch) squares. The center and corner points are marked with holes. The required marks can be transferred to the material.

- > Mark the center of an embroidery motif on the fabric, using a water-soluble pen.

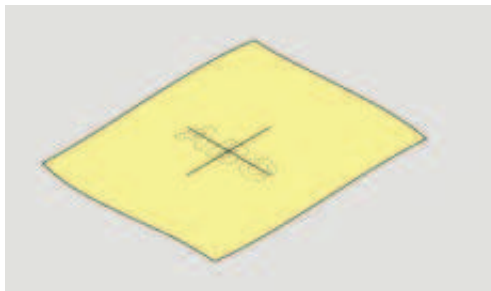

- > Loosen the screw on the outer hoop.
- > Remove the inner hoop.
- > Make sure that the arrows marks of both hoops match.
- > Attach the template holder.



## Overview Embroidery functions



- |   |   |   |  |
|---|---|---|--|
| 1 | Centering the embroidery hoop to the needle | 4 | Grid on/off                                      |
| 2 | Moving the hoop to the back                 | 5 | Motif center                                     |
| 3 | Moving the module for the sewing mode       | 6 | Virtual Positioning (is visible while scrolling) |

### Center the needle to the embroidery hoop

Relocating the embroidery hoop facilitates threading when the needle is close to the embroidery hoop.



- > Touch the icon «Embroidery hoop display/Embroidery hoop selection».



- > Touch the icon «Center the needle to the embroidery hoop».
- > Threading the upper thread.



- > Push the button «Start/Stop» to move the embroidery hoop back to the last position.

### Moving the hoop to the back

To facilitate changing the bobbin, it is recommended to move the hoop to the back before threading. This makes it easier to open the bobbin cover.



- > Touch the icon «Embroidery hoop display/Embroidery hoop selection».



- > Touch the icon «Move the hoop to the back».
- > Thread the bobbin thread (see page 49).



- > Push the button «Start/Stop» to move the embroidery hoop back to the last position. If necessary, pull the upper thread back.

### Moving the module for the sewing mode

The embroidery module can be positioned so that any sewing projects can be carried out even if the module is connected.



- > Touch the icon «Embroidery hoop display/Embroidery hoop selection».
- > Remove the hoop.

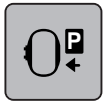

> Touch the icon «Move the module for the sewing mode».



> Touch the icon «Home».



> Touch the icon «Sewing mode».

### Grid on/off

When the center of the hoop and the grid are displayed, the embroidery motif can be positioned more exactly.



> Touch the icon «Embroidery hoop display/Embroidery hoop selection».

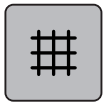

> Touch the icon «Grid on/off» to display the center of the hoop on the display.

> Touch the icon «Grid on/off» again to display the grid.

> Touch the icon «Grid on/off» again so that the center of the hoop and the grid disappear.

### Locating the center of the embroidery motif

The embroidery hoop is positioned so that the needle is exactly above the center of the embroidery motif or the motif begin.



> Touch the icon «Embroidery hoop display/Embroidery hoop selection».



> Touch the icon «Center of the embroidery motif» to position the hoop so that the needle is placed exactly over the center of the embroidery motif.

> Touch the icon «Center of the embroidery motif» again to position the hoop so that the needle is placed exactly over the motif start.

### Virtual positioning of the embroidery hoop

The embroidery hoop is automatically moved to the new position as soon as the embroidery motif is repositioned. Therefore, the icon «Virtual positioning» is activated automatically and outlined in yellow when an embroidery hoop is attached.

Prerequisite:

- The hoop is attached.



> Touch the icon «Embroidery hoop display/Embroidery hoop selection».



> Touch the icon «Virtual positioning» to deactivate the automatic movement of the hoop when having repositioned the embroidery motif.

– The icon «Virtual positioning» is not outlined in yellow.

> Touch the icon «Virtual positioning» again to activate the automatic movement of the hoop when having repositioned the embroidery motif.

## 14 Setup Program

### 14.1 Adjusting the embroidery settings in the Setup Program

Further information about this topic (see page 56).

## 15 Creative embroidering

### 15.1 Overview embroidering



- |   |   |                                |
|---|---|--------------------------------|
| 1 | Embroidery time/Embroidery motif size in mm 3               | Area to be embroidered or inch |
| 2 | Scaling up, downsizing and moving the embroidery motif view | 4 «i»-Dialog                   |

### 15.2 Selecting and changing the embroidery motif

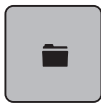

- > Touch the icon «Selection».



- > Touch the icon «Upload embroidery motif».
- > Select a new embroidery motif.

### 15.3 Checking the embroidery time and the embroidery motif size

In the display «Editing» at lower right (1), the estimated embroidery time is indicated in minutes and the width and height of the embroidery motif is indicated in millimeters.



## 15.4 Regulating the speed

The sewing speed can be adjusted infinitely variable with the slide.

- > Move the slide to the left to reduce the sewing speed.
- > Move the slide to the right to increase the sewing speed.

## 15.5 Editing the embroidery motif

### Overview Editing embroidery motif



- |   |  |    |                             |
|---|--|----|-----------------------------|
| 1 | Zoom out                                     | 8  | Mirror image left/right     |
| 2 | Zoom in                                      | 9  | Mirror image up/down        |
| 3 | Moving the view                              | 10 | Duplicating                 |
| 4 | Moving the motif                             | 11 | Deleting                    |
| 5 | Moving the motif                             | 12 | Checking the motif size     |
| 6 | Rotating the motif                           | 13 | Altering the kind of stitch |
| 7 | Altering the embroidery motif proportionally |    |                             |

### Scaling up the embroidery motif view

The view of the embroidery motif can be scaled up. In addition to that, the view can be adjusted with or without changing the embroidery position.

- > Select an embroidery motif.
- > Touch the icon «Zoom in» to edit the view of the embroidery motif.



- > Touch the icon «Zoom in» 1 to 4 times to enlarge the view of the embroidery motif gradually.



- > Touch the icon «Zoom out» 1 to 4 times to get back to the Edit Mode.

### Downsizing the embroidery motif view

The view of the embroidery motif can be downsized. In addition to that, the view can be adjusted with or without changing the embroidery position.

- > Select an embroidery motif.
- > Touch the icon «Zoom in» to edit the view of the embroidery motif.



- > Touch the icon «Zoom out» 1 to 4 times to downsize the view of the embroidery motif gradually.

### Moving the embroidery motif view

The view of the embroidery motif can be moved. In addition to that, the view can be adjusted with or without changing the embroidery position.



- > Select an embroidery motif.
- > To activate the icon «Move the view», touch the icon «Zoom in».



- > Touch the icon «Move the view».
  - The icon turns dark gray.
- > Alter the view of the embroidery motif.
  - The embroidery position is not altered.



- > Touch the icon «Zoom out» to get back to the Edit Mode.

### Moving the embroidery motif in enlarged view

The view of the embroidery motif can be moved. In addition to that, the view can be adjusted with or without changing the embroidery position.



- > Select an embroidery motif.
- > To activate the icon «Move the view», touch the icon «Zoom in».



- > Touch the icon «Move the stitch pattern».
- > Move the view of the embroidery motif using the touchscreen pen/finger.
  - The embroidery position is altered.



- > Touch the icon «Zoom out» to get back to the Edit Mode.

### Moving the embroidery motif



- > Select an embroidery motif.
- > Touch the icon «i»-Dialog.



- > Touch the icon «Move the stitch pattern».
- > Turn the «Upper Multifunction knob» to move the embroidery motif horizontally in 1/10-mm steps.
- > Turn the «Lower Multifunction knob» to move the embroidery motif vertically in 1/10-mm steps or
- > touch the embroidery motif, keep it pressed and move it as you like.
  - The relocation is indicated in the yellow-framed icons.







- > Touch the icon «Center of the embroidery motif».
- The embroidery motif is repositioned in the center of the embroidery hoop.

### Rotating motif



- > Select an embroidery motif.
- > Touch the icon «i»-Dialog.

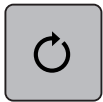

- > Touch the icon «Rotate the motif».
- > Turn the «Upper Multifunctional knob» or the «Lower Multifunctional knob» to the right to rotate the embroidery motif clockwise.
- > Turn the «Upper Multifunctional knob» or the «Lower Multifunctional knob» to the left to rotate the embroidery motif counter-clockwise.



- > Touch the icon «Rotate the motif +90°» to rotate the embroidery motif in 90°-steps.

### Altering the embroidery motif size proportionally



Enlargements or reductions of the motif size up to maximum 20% achieve the best results.

If the motif size is to be altered by more than 20%, the motif should be adapted in a separate embroidery software and then reloaded onto the machine.



- > Select an embroidery motif.
- > Touch the icon «i»-Dialog.



- > Touch the icon «Alter the embroidery size».



- > Touch the icon «Retain the proportions» so that the icon is outlined in white.



- > Turn the «Upper/Lower Multifunction knob» to the right to scale up the embroidery motif proportionally.
- > Turn the «Upper/Lower Multifunction knob» to the left to downsize the embroidery motif proportionally.

## Altering the embroidery motif size disproportionately



Enlargements or reductions of the motif size up to maximum 20% achieve the best results.

If the motif size is to be altered by more than 20%, the motif should be adapted in a separate embroidery software and then reloaded onto the machine.



- > Select an embroidery motif.
- > Touch the icon «i»-Dialog.



- > Touch the icon «Alter the embroidery size».



- > To alter the embroidery motif disproportionately, touch the icon «Retain the proportions» so that the icon is not framed in white.

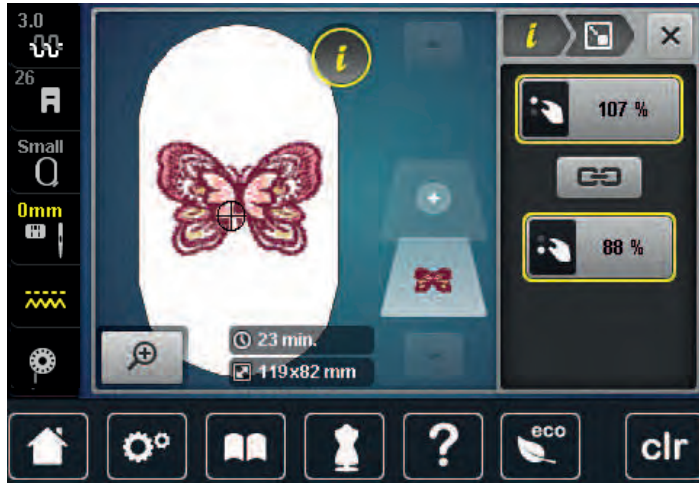

- > Turn the «Upper Multifunctional knob» to move the embroidery motif horizontally.
- > Turn the «Lower Multifunctional knob» to alter the embroidery motif vertically.

## Mirroring embroidery motifs

Embroidery motifs can be mirror-imaged both vertically and horizontally.



- > Select an embroidery motif.
- > Touch the icon «i»-Dialog.



- > Touch the icon «Mirror image left/right» to mirror the embroidery motif vertically.



- > Touch the icon «Mirror image up/down» to mirror the embroidery motif horizontally.

## Changing the stitch type

If the satin stitches are too long, they can be changed to step stitches.

- > Select an embroidery motif.



> Touch the icon «i»-Dialog.



> Touch the icon «Change the stitch type».



- > Touch the switch in the upper section of the display (1) to change the satin stitch to the step stitch.
- > Adjust the desired stitch length (2) with the icons «-» or «+».

### Altering the stitch density

If the satin stitches are embroidered too densely, the stitch density can be adjusted.

- > Select an embroidery motif.
- > Touch the icon «i»-Dialog.



- > Touch the icon «Change the stitch type».
- > Adjust the desired stitch density (1) with the icons «-» or «+».



### Checking the size and the position of the embroidery motif

It can be checked whether or not the embroidery motif matches the designated position/location on the fabric. Points which are beyond the embroidery hoop are not traveled to.

- > Select an embroidery motif.



> Touch the icon «i»-Dialog.

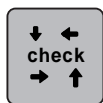

> Touch the icon «Check embroidery motif size».

– The embroidery hoop travels all the way until the needle is at the position as it is indicated in the display.

> Touch the icon «Corner top left» to select the top left corner of the embroidery motif.

– The embroidery hoop travels all the way until the needle is at the position as it is indicated in the display.

> Touch the icon «Corner top right» to select the top right corner of the embroidery motif.

– The embroidery hoop travels all the way until the needle is at the position as it is indicated in the display.

> Touch the icon «Corner bottom left» to select the bottom left corner of the embroidery motif.

– The embroidery hoop travels all the way until the needle is at the position as it is indicated in the display.

> Touch the icon «Corner bottom right» to select the bottom right corner of the embroidery motif.

– The embroidery hoop travels all the way until the needle is at the position as it is indicated in the display. If the embroidery motif hasn't been positioned correctly yet, the position can be altered via the «Upper/Lower Multifunction knobs» and the complete embroidery positions can be checked again.



> Touch the icon «Embroidery motif center» to bring the needle to the center of the embroidery motif.

> Turn the «Upper Multifunctional knob» to move the embroidery motif horizontally.

> Turn the «Lower Multifunctional knob» to move the embroidery motif vertically.

## Deleting an embroidery motif

The active embroidery motif is deleted.

> Select an embroidery motif.

> Touch the icon «i»-Dialog.



> Touch the icon «Delete».

## 15.6 Creating lettering

### Overview embroidery alphabets

Embroidery motif	Name
ABC	Swiss Block
<i>ABC</i>	Anniversary
Abc	Alphabet Guinevere
ABC	Drifter
ABC	Childs Play
АБВ	Russian Textbook

### Creating words/sentences



Lettering is always embroidered in one color. To embroider single letters or single words in another color, every letter or every word has to be selected individually and placed in the area to be embroidered.

Lettering can be positioned within the hoop as you like. When the embroidery motif is positioned outside the area to be embroidered, the hoop is outlined in red on the display. With the hoop selection it can be checked whether or not the embroidery motif can be embroidered in another hoop. When the lettering does not fit in any hoop, two single words can be combined and positioned below each other as the following example will show.



- > Select the file «Alphabets».
- > Select the font.
- > Enter the text «Made to».
- > Touch the icon (1) (standard setting) to use upper case letters.
- > Touch the icon (2) to use lower case letters.
- > Touch the icon (3) to use numbers and mathematic characters.
- > Touch the icon (4) to use special characters.





> Touch the icon «DEL» to delete single letters of the entered text.



> Touch the icon «Confirm» to accept the text.



> Touch the icon «Embroidery hoop display/Embroidery hoop selection».  
 > Select the hoop.  
 > Touch the icon «Embroidery hoop display/Embroidery hoop selection» again to go back to the Edit Mode.

### Editing words/sentences



> Touch the icon «i»-Dialog.

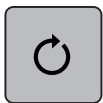

> Touch the icon «Rotate the embroidery motif».



> Touch the icon «+90» to rotate the text by 90°.  
 > Touch the icon «i» (1).



> Touch the icon «Move the motif».  
 > Turn the «Upper Multifunction knob» to move the embroidery motif horizontally.  
 > Turn the «Lower Multifunction knob» to move the embroidery motif vertically.  
 > Touch the yellow-framed icons to reset the alterations to default setting.



## 15.7 Changing the colors of the embroidery motif

### Overview changing the color



- |   |                             |   |                      |
|---|-----------------------------|---|----------------------|
| 1 | Colors of embroidery motifs | 4 | Altering color/brand |
| 2 | Preview for selected color  | 5 | Color information    |
| 3 | Allocating thread brand     |   |                      |

### Changing the colors



Lettering is always embroidered in one color. To embroider single letters or single words in another color, every letter or every word has to be selected individually and placed in the area to be embroidered.



- > Select the embroidery motif.
- > Touch the icon «Color information».

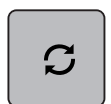

- > Touch the icon «Alter Color/Brand» next to the color which is to be changed.
- > Swive upwards or downwards on the display with the touchscreen pen/finger to see more colors.



- > Touch the icon «Color selection by number» to select the color by entering the color number.
- > Select the desired color.
- > The color selection needs to be confirmed by touching the color bar on the left side.

### Changing the thread brand



- > Select the embroidery motif.
- > Touch the icon «Color information».

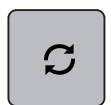

- > Touch the icon «Alter color/brand».



- > To show more thread brands, touch the icons «Scroll left» and «Scroll rights» in the upper part of the screen.



- > Touch the icon «Allocate thread brand».
  - Any thread colors of the selected embroidery motif will be matched with the selected thread brand.

## 15.8 Embroidering the embroidery motif

### Overview Embroidery menu



- |   |  |   |  |
|---|--|---|--|
| 1 | Basting  | 5 | Multi-colored embroidery motif on/off                  |
| 2 | Moving the hoop                                    | 6 | Color indication                                       |
| 3 | Embroidery sequence control when the thread breaks | 7 | Increasing the embroidery speed (appears by scrolling) |
| 4 | Cutting connecting stitches                        |   |  |

### Adding basting stitches

The basting stitches can be embroidered along the embroidery motif. Therefore the connection between the fabric and the stabilizer can be improved.



- > Select an embroidery motif.
- > Touch the icon «Embroidering».



- > Touch the icon «Basting» to embroider basting stitches along the embroidery motif.
- > Touch the icon «Basting» again to embroider basting stitches along the embroidery hoop.
- > Touch the icon «Basting» again to deactivate the basting stitches.

### Moving the hoop

If the embroidery motif is so big that repeated rehooping is necessary, the embroidered motif can be moved again.



- > Select an embroidery motif.
- > Touch the icon «Embroidering».





- > Touch the icon «Move the hoop».
- > Turn the «Upper Multifunctional knob» to move the hoop horizontally.
- > Turn the «Lower Multifunctional knob» to move the hoop vertically.



- > Touch the icon «Embroidering» in the process navigation to accept the settings.

### Embroidery sequence control when thread breaks

When the thread breaks, the needle can be repositioned in the embroidery motif by means of the embroidery sequence control.



- > Select an embroidery motif.
- > Touch the icon «Embroidering».



- > Touch the icon «Embroidery sequence control when thread breaks».
  - In the left portion of the display a compact view of the embroidery motif is displayed. On the right side the enlarged embroidery motif is displayed.
- > Select the desired position in the compact view using the touchscreen pen/finger.
- > Turn the «Upper Multifunctional knob» to move the hoop stitch by stitch.
- > Turn the «Lower Multifunctional knob» to move the hoop in large steps.
  - The number in the yellow-framed icon indicates the number of stitches within the embroidery sequence.



- > Touch the icon «Magnifier» to select the desired stitch via entry.

### Cutting connecting stitches

The function is activated by default and the connecting stitches are cut automatically. When the function is deactivated, the connecting stitches between the embroidery motifs must be cut manually.



- > Select an embroidery motif.
- > Touch the icon «Embroidering».



- > Touch the yellow-framed icon «Cut the connecting stitches» to deactivate the function.
- > Touch the yellow-framed icon «Cut the connecting stitches» again to activate the function.

### Multi-colored embroidery motif on/off

Multi-colored embroidery motifs can also be embroidered in one color.



- > Select an embroidery motif.
- > Touch the icon «Embroidering».

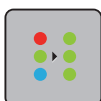

- > Touch the icon «Multi-colored embroidery motif on/off».
  - The embroidery motif is embroidered in one color.

## Color indication

Every color of the embroidery motif can be selected individually. The hoop moves to the first stitch of the current color. The currently active color can be embroidered individually or in another sequence.

- > Select an embroidery motif.
- > Touch the icon «Embroidering».



- > Touch the icon «Scroll down» to select the next color of the embroidery motif.



- > Touch the icon «Scroll up» to select the previous color of the embroidery motif.



## 15.9 Free arm embroidering

Free arm embroidering is defined as embroidering tubular fabrics or garments which are positioned around the free arm of the embroidery machine while being embroidered. Often used with sleeves, pant legs or other narrow-tailored garments.



A tubular piece of fabric can be pulled over the free arm of the machine easily when the free arm is positioned to the left in parking position before the hoop is attached or removed. Push the button «Start/Stop» to move the embroidery hoop back to the embroidery position again.

Make sure to use a full bobbin as the embroidery hoop needs to be removed for changing the bobbin.

Endless embroidery can be closed to a ring easily and exactly along the tube edge.

The movability of the embroidery arm can be limited or impeded with very narrow tubes. Therefore please make sure that the embroidery hoop can move forwards and backwards sufficiently. An impediment of the embroidery arm caused by a tube which is too tight can result in embroidery motif offset or in damaging the fabric.

### Checking the movability of the free arm

Please note: With tiny fabric tubes, deactivate the thread away in the Setup Program if necessary.

- > Open the embroidery motif on the machine and edit as desired.
- > Mark the embroidery motif position and the size on the fabric in a suitable way.
- > Select the embroidery hoop as small as possible.
- > Hoop or stick the fabric along with the appropriate stabilizer in the embroidery hoop, depending on the stabilizer.
- > Pull the fabric tube carefully over the free arm of the machine and attach the embroidery hoop at the clutch of the embroidery module.
- > If necessary, reposition the embroidery motif.
- > Previously check whether the embroidery hoop can be moved forwards and backwards according to the embroidery motif size.

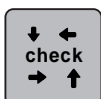

- > Touch the icon «Check embroidery motif size».
- > After the successful check of the embroidery motif size, start the embroidery process.

## 15.10 Administering embroidery motifs

### Administering embroidery motifs



- |   |                              |   |          |
|---|------------------------------|---|----------|
| 1 | Loading the embroidery motif | 3 | Deleting |
| 2 | Saving the embroidery motif  |   |          |

### Saving embroidery motifs in the personal memory

In the filing system «Personal memory» any stitch patterns, also those which have been individually edited, can be saved.

- > Select an embroidery motif.
- > Edit the embroidery motif.
- > Touch the icon «Selection».



- > Touch the icon «Save the motif».
  - The embroidery motif to be saved is outlined in yellow.
  - The icon «Embroidery machine» is activated.



- > Touch the icon «Confirm».

### Saving the embroidery motif on the BERNINA USB stick

- > Select an embroidery motif.
- > Edit the embroidery motif.
- > Touch the icon «Selection».

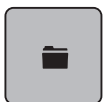

- > Touch the icon «Save the motif».
  - The embroidery motif to be saved is outlined in yellow.

- > Insert the BERNINA USB stick into the USB port of the machine.



- > Touch the icon «USB stick».



- > Touch the icon «Confirm».

### Overwriting the embroidery motif in the personal memory

- > Select an embroidery motif.
- > Edit the embroidery motif.
- > Touch the icon «Selection».



- > Touch the icon «Save the motif».
  - The embroidery motif to be saved is outlined in yellow.
  - Touch the icon «Embroidery machine» is activated.



- > Select the embroidery motif which is to be overwritten.



- > Touch the icon «Confirm».

### Overwriting the embroidery motif on the BERNINA USB stick

- > Select an embroidery motif.
- > Edit the embroidery motif.
- > Touch the icon «Selection».



- > Touch the icon «Save the motif».
  - The embroidery motif to be saved is outlined in yellow.
- > Insert the BERNINA USB stick into the USB port of the machine.



- > Touch the icon «USB stick».
- > Select the embroidery motif which is to be overwritten.



- > Touch the icon «Confirm».

### Importing stitch patterns

Stitch patterns or stitch pattern combinations can be imported from the Sewing mode to the Embroidery mode and edited like embroidery motifs. Therefore endless embroidery can be combined quickly and easily and saved as an embroidery motif in the file «Personal embroidery motifs».



- > Touch the icon «Home».



- > Touch the icon «Sewing mode».
- > Select a stitch pattern.



- > Touch the icon «Home».



- > Touch the icon «Embroidery mode».
  - The stitch pattern is saved automatically in the file «Personal embroidery motifs».



- > Select the file «Personal embroidery motifs».

- > Select an embroidery motif.



### Loading an embroidery motif from the personal memory



- > Touch the icon «Selection».



- > Touch the icon «Upload embroidery motif».



- > Select the file «Personal embroidery motifs».
- > Select an embroidery motif.

### Loading an embroidery motif from the BERNINA USB stick



- > Touch the icon «Selection».
- > Insert the BERNINA USB stick into the USB port of the machine.



- > Touch the icon «USB stick».
- > Select a personal embroidery motif.

### Deleting an embroidery motif from the personal memory

The embroidery motifs which are saved in the personal memory can be deleted individually.



- > Touch the icon «i-Dialog».



- > Touch the icon «Delete».



- Touch the icon «Embroidery machine» is activated.

- > Select the embroidery motif which is to be deleted.



- > Touch the icon «Confirm».



## 16 Embroidery

### 16.1 Embroidering via the button «Start/Stop»

In case of a power cut the embroidery process is interrupted. After the restart the machine goes to the position which was embroidered last.



- > Push the button «Start/Stop» to start the embroidery machine.
  - All parts of the motif being in the current color are embroidered.
  - The embroidery machine stops automatically at the end.
  - Both threads are cut automatically.
  - The embroidery machine switches to the next color automatically.



- > Change the upper thread.
- > Push the button «Start/Stop» to embroider the new color.
  - After having completed the embroidery motif, the machine stops automatically and the threads are cut automatically.

### 16.2 Increasing the embroidery speed

To ensure the best embroidery quality, the speed when embroidering is reduced depending on the embroidery position. Choose between the two options to either embroider at optimal or maximum speed. Standard = optimal speed. It has to be considered that the quality of the embroidered embroidery motif at maximum speed cannot be ensured.

By switching the machine off and on, the optimal embroidery speed is activated.

Prerequisite:

- The embroidery motif is selected.



- > Touch the icon «Embroidery speed».
  - The maximum speed is activated.
- > Touch the icon «Embroidery speed» again.
  - The optimal speed is activated.

### 16.3 Adjusting the upper thread tension

The basic setting of the upper thread tension is provided automatically as soon as a stitch pattern or an embroidery motif is selected.

When of using other types of sewing or embroidery threads, the optimal tension may vary. Therefore it may be necessary to adjust the upper thread tension according to the sewing or embroidering project as well as the desired stitch pattern or the embroidery motif individually.

The higher the upper thread tension, the tighter the upper thread which means that the bobbin thread is pulled up to the top of the fabric. When the upper thread tension is low, the upper thread is less tightened which means that the bobbin thread is pulled up less.

Alterations of the upper thread tension affect the currently selected stitch pattern or embroidery motif. Permanent alterations of the upper thread tension for the sewing mode (see page 52) and for the embroidering mode (see page 56) can be made in the Setup Program.

- > Touch the icon «Upper thread tension».

- > Move the slide using the touchscreen pen/finger to increase or reduce the upper thread tension.



- > Touch the yellow-framed icon on the right side to reset the alteration to default setting.
- > Touch the yellow-framed icon on the left side to reset the alteration to default setting in the **Setup Program**.

## 16.4 Embroidering via the foot control

Embroidering via the foot control is recommended when only a short sequence has to be embroidered. While embroidering, the foot control must be pressed down all the time.

- > Press the foot control to start embroidering.



## 17 Attachment

### 17.1 Maintenance and cleaning

#### Cleaning the display

- > Clean the display in the switched off status with a soft slightly damp microfiber cloth.

#### Cleaning the feed dog

Remove the thread remnants under the stitch plate regularly.



#### Electronically driven components

Risk of injury near the needle and the hook.

- > Raise the presser foot.
- > Switch the machine off and disconnect it from the power supply system.

- > Remove the presser foot and the needle.
- > Lower feed dog.



- > Remove the stitch plate.
- > Clean the feed dog with the brush.

#### Cleaning the hook



#### Electronically driven components

Risk of injury near the needle and the hook.

- > Switch the machine off and disconnect it from the power supply system.

- > Open the bobbin cover.
- > Remove the bobbin case.
- > Push the fastening bracket to the left.



- > Flap down the fastening bracket along with the black hook race cover.
- > Remove the hook.

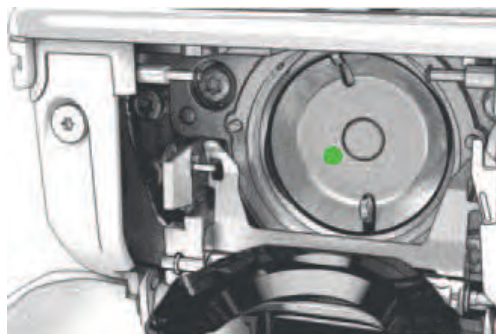

- > Clean the hook race area with the brush; never use a sharp instrument.
- > Hold the hook at the pin in the center with two fingers.
- > Lead the hook, lower edge ahead, angular top-down behind the hook race cover.
- > Position the hook with the two lugs meeting the openings in the hook, the colored mark on the hook driver should be visible through the hole in the hook.
- > Insert the hook.
  - The hook is magnetic and therefore fastened to the correct position.
- > Close the hook race cover and the fastening bracket until the release bracket engages.
- > As a check, turn the handwheel.
- > Insert the bobbin case.

### Lubricating the hook



CAUTION

#### Electronically driven components

Risk of injury near the needle and the hook.

- > Switch the machine off and disconnect it from the power supply system.

NOTICE

#### Lubricating the hook

Too much oil can pollute the fabric and the thread.

- > Always sew a test sample first.
- > Remove the bobbin case.
- > Push the fastening bracket to the left.



- > Flap down the fastening bracket along with the black hook race cover.

- > Remove the hook.

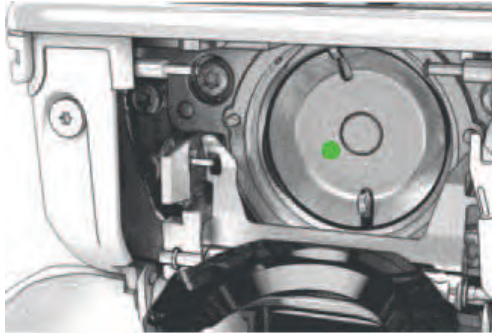

- > Give one drop of BERNINA oil down in the hook race.



- > Give one drop of oil in each of the two oil depots so that the felts are damp and make sure that the red-marked surface of the hook sleeve remains free of oil.



- > Hold the hook at the pin in the center with two fingers.
- > Lead the hook, lower edge ahead, angular top-down behind the hook race cover.
- > Position the hook with the two lugs meeting the openings in the hook, the colored mark on the hook driver should be visible through the hole in the hook.
- > Insert the hook.
  - The hook is magnetic and therefore fastened to the correct position.
- > Close the hook race cover and the fastening bracket until the release bracket engages.
- > As a check, turn the handwheel.
- > Insert the bobbin case.





## 17.2 Troubleshooting



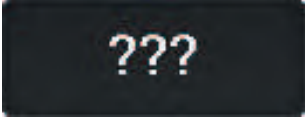

Failure	Cause	Repair
<b>Uneven stitch formation</b>	Upper thread too tight or too loose.	> Adjust the upper thread tension.
	Needle blunt or bent.	> Replace the needle, make sure that a new BERNINA quality needle is used.
	Poor quality needle.	> Use a new BERNINA quality needle.
	Poor quality thread.	> Use quality thread.
	Incorrect needle/thread combination.	> Match the needle with the thread size.
	Incorrectly threaded.	> Rethread.
	The fabric has been pulled.	> Feed the fabric evenly.
<b>Uneven stitch formation</b>	Incorrect bobbin case is used.	> Use the supplied bobbin case marked with the triangle.
		
<b>Skipped stitches</b>	Incorrect needle.	> Use the needle system 130/705H.
	Needle blunt or bent.	> Replace the needle.
	Poor quality needle.	> Use a new BERNINA quality needle.
	The needle is incorrectly inserted.	> Insert the needle with the flat side to the back as far up as it will go into the needle holder and tighten the screw.
	Incorrect needle point.	> Match the needle point to the texture of the material.
<b>Faulty stitching</b>	Thread remnants between the thread tension discs.	> Fold a piece of thin material and slide the folded edge (not the raw edges) between the thread tension discs.
	Incorrectly threaded.	> Rethread.
	Thread remnants below the bobbin case spring.	> Remove the thread remnants under the spring.

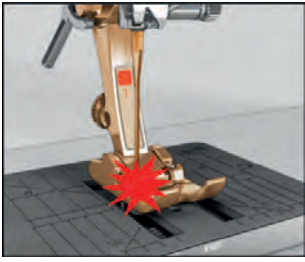



Failure	Cause	Repair
<b>Stitch width not adjustable</b>	The selected needle and stitch plate cannot be used in combination.	<ul style="list-style-type: none"> <li>&gt; Replace the needle.</li> <li>&gt; Replace the stitch plate.</li> </ul>
<b>Speed too low</b>	Unfavorable room temperature.	> Place the machine in a warm room one hour before use.
	Settings in the Setup Program.	<ul style="list-style-type: none"> <li>&gt; Adjust the sewing speed in the Setup Program.</li> <li>&gt; Adjust the slide.</li> </ul>
<b>The machine doesn't start</b>	Unfavorable room temperature.	<ul style="list-style-type: none"> <li>&gt; Place the machine in a warm room one hour before use.</li> <li>&gt; Connect the machine and switch it on.</li> </ul>
	The machine is damaged.	> Contact the specialized BERNINA dealer.
<b>The light of the button «Start-/Stop» doesn't light up</b>	Light is defect.	> Contact the specialized BERNINA dealer.
<b>Neither the sewing light nor the light on the free arm lights up</b>	Settings in the Setup Program.	> Activate it in the Setup Program.
	The sewing light is defect.	> Contact the specialized BERNINA dealer.
<b>Upper thread indicator doesn't react</b>	Settings in the Setup Program.	> Activate it in the Setup Program.
	The upper thread indicator is defect.	> Contact the specialized BERNINA dealer.
<b>Bobbin thread indicator doesn't react</b>	Settings in the Setup Program.	> Activate it in the Setup Program.
	The bobbin thread indicator is defect.	> Contact the specialized BERNINA dealer.
<b>Error during software update</b>	USB stick is not recognized.	> Use a BERNINA USB stick.
	The update process is blocked and the hourglass on the display is inactive.	<ul style="list-style-type: none"> <li>&gt; Remove the USB stick.</li> <li>&gt; Switch the machine off.</li> <li>&gt; Switch the machine on.</li> <li>&gt; Follow the instruction on the display.</li> </ul>
	Date of the software update cannot be found.	<ul style="list-style-type: none"> <li>&gt; Unzip the update data.</li> <li>&gt; Save data of the software update directly on the data medium and not in a file on the USB stick.</li> </ul>

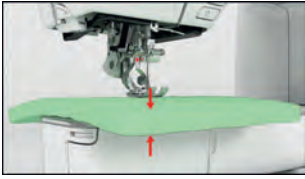
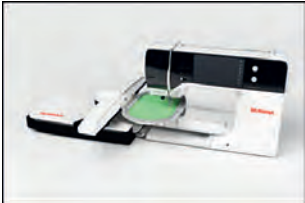
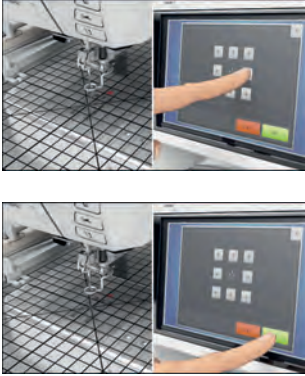

### 17.3 Error messages

Message on the display	Cause	Repair
	Stitch number unknown.	> Check the entry and enter the new number.
	Selection of the stitch pattern not possible in the combi mode.	> Combine other stitches.
	The feed dog is not lowered.	> Push the button «Feed dog up/down» to lower the feed dog.
	The selected needle and stitch plate cannot be used in combination.	> Replace the needle. > Replace the stitch plate.
	The needle is not at its top end.	> Adjust the needle position via the handwheel.
	The upper thread is used up.	> Rethread.
	The upper thread has broken.	> Rethread.
	The bobbin thread is used up.	> Rethread.
	The bobbin thread has broken.	> Clean the hook. > Rethread.

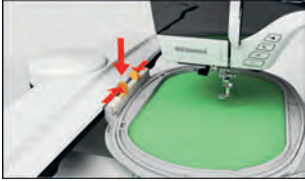
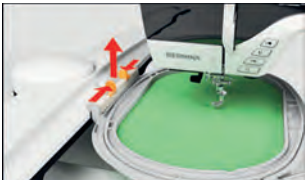
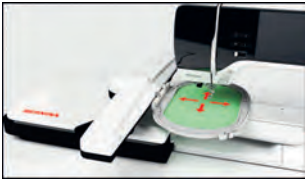
Message on the display	Cause	Repair
	The main motor isn't running.	<ul style="list-style-type: none"> <li>&gt; Turn the handwheel clockwise until the needle is at its top position.</li> <li>&gt; Remove the stitch plate.</li> <li>&gt; Remove the thread remnants.</li> <li>&gt; Clean the hook.</li> <li>&gt; Remove the hook and make sure that there are no pieces of broken needle points on the magnetic back of the hook.</li> <li>&gt; Deactivate the thread catcher in the Setup Program.</li> </ul>
	Incorrect presser foot for the BERNINA Dual Feed.	<ul style="list-style-type: none"> <li>&gt; Attach a presser foot with the designation «D».</li> </ul>
	The fabric under the presser foot is too thick.	<ul style="list-style-type: none"> <li>&gt; Reduce the fabric thickness.</li> </ul>
	The contact between the machine and the embroidery module is interrupted due to vibrations.	<ul style="list-style-type: none"> <li>&gt; Make sure that the module and the machine are standing on a stable, even surface.</li> <li>&gt; Connect the embroidery module to the machine.</li> </ul>
	The needle position doesn't correspond with the center of the hoop.	<ul style="list-style-type: none"> <li>&gt; Calibrate the hoop.</li> </ul>
	The embroidery module is not attached.	<ul style="list-style-type: none"> <li>&gt; Connect the embroidery module to the machine.</li> <li>&gt; Contact the specialized BERNINA dealer to have the machine checked.</li> </ul>

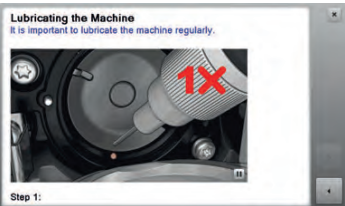

Message on the display	Cause	Repair
	The hoop is not attached.	> Attach the hoop.
	The hoop is attached.	> Remove the hoop.
	The movement of the hoop follows.	> Touch the icon «Confirm».
	The embroidery motif is partly outside the hoop.	> Reposition the embroidery motif and start embroidering it again.
	The embroidery motif is too large.	> Reduce the size of the embroidery motif. > Attach a larger hoop.
Too less free capacity on the BERNINA USB stick (optional accessory).	Not enough free capacity on the BERNINA USB stick (optional accessory).	> Make sure that the BERNINA USB stick (optional accessory) is used. > Delete data from the BERNINA USB stick (optional accessory).
No personal data on the BERNINA USB stick (optional accessory).	No personal data for recovery available on the BERNINA USB stick (optional accessory).	> Make sure that the data and settings have been saved on the BERNINA USB stick (optional accessory).
The recovery of personal data has failed.	The software update has been successful but the personal data couldn't be recovered.	> Make sure that the data and settings have been saved on the BERNINA USB stick (optional accessory). > Transfer saved data to the machine.

Message on the display	Cause	Repair
No BERNINA USB stick is inserted. Make sure that during the complete automatic update always the same BERNINA USB stick remains inserted.	The BERNINA USB stick (optional accessory) is not inserted.	<ul style="list-style-type: none"> <li>&gt; Use a BERNINA USB stick (optional accessory) providing enough free capacity.</li> </ul>
The update of the software has failed.	The latest software version cannot be found on the USB stick.	<ul style="list-style-type: none"> <li>&gt; Make sure that the compressed zip file has been unzipped for the software update.</li> <li>&gt; Check whether the data for the software update are saved directly on the data medium and not in a file on the USB stick.</li> <li>&gt; Update the software.</li> </ul>
 	The machine needs cleaning/ lubricating.	<ul style="list-style-type: none"> <li>&gt; Clean the machine.</li> <li>&gt; Lubricate the machine.</li> </ul> <p>Important information on lubricating:</p> <ul style="list-style-type: none"> <li>&gt; Too much oil can pollute the fabric and the thread.</li> <li>&gt; After lubricating, embroider a test piece first.</li> </ul>
The automatic thread cutter (at the thread catcher) needs cleaning.	The automatic thread cutter needs cleaning. The message appears every time when the machine is started as soon as 1000 cutting cycles have been carried out.	<ul style="list-style-type: none"> <li>&gt; Touch the icon «Confirm». <ul style="list-style-type: none"> <li>– The machine calls up the function «Clean the thread catcher».</li> </ul> </li> <li>&gt; Clean the thread catcher according to the instructions on the display. <ul style="list-style-type: none"> <li>– The counter for the cutting cycles is reset.</li> </ul> </li> </ul>



## 17.5 Technical data

Term	Value	Unit
Maximum fabric thickness	12,5 (0,49)	mm (in)
Sewing light	30	LED
Maximum speed	1000	Stitches per minute
Measurements without the spool pin (W × H × D)	522 × 358 × 214 (20,55 × 14,09 × 8,43)	mm (in)
Weight	14 (30,86)	kg (lb)
Energy consumption	140	W
Input voltage	100 – 240	V
Protection class (Electrical engineering)	II	

## 18 Overview stitch patterns

### 18.1 Overview Stitch patterns

#### Practical stitches

1	2	3	4	5	6	7	8	9	10	11
12	13	14	15	16	17	18	19	20	21	22
23	24	25	26	29	31	32	33			

#### Buttonholes

51	52	53	54	56	57	59	63	64	65	69
60	61	62								

#### Decorative stitches

##### Natural stitches

101	102	103	104	107	108	110	111	112	113	114
115	119	122	123	124	125	129	133	134	136	137
143	144	145	146	147	149	150	151	152		

Cross stitches

301	302	303	304	305	306	307	308	309	311	314
323	326	371	372	373	374	375	376	377		

Satin stitches

401	402	405	406	407	408	412	413	414	415	416
417	419	422	423	424	425	426	428	429	430	431
437	439	441	442	445	446	447	448	450	451	457
461	464	465	468	471	473					

Ornamental stitches

601	602	603	604	605	606	607	608	609	610	611
612	613	614	615	616	618	619	621	622	623	624
625	626	630	631	633	635	639	640	641	642	643
644	645	648	649	651	653	656	657	658	660	661

662	663	664	677	679	680	681	682	683	684	685
686	690	692	694	697	698	699				

Heirloom stitches

701	702	705	706	708	709	710	711	712	713	714
717	719	720	721	722	723	724	725	726	727	728
730	731	732	734	735	736	737	738	740	741	742
743	746	747	748	749	750	751	761	763	764	765
766	767	768	769	772	775	777	779			

Novelty

903	904	906	907	908	911	913	914	916	919	920
921	925	929	930	934	935	937	938	939	940	941
942	943	944	945	946	947	948				

Quilt stitches

1324 	1325 	1326 	1327 	1328 	1329 	1330 	1331 	1332 	1333 	1334 
1335 	1336 	1337 	1338 	1339 	1340 	1341 	1342 	1343 	1344 	1345 
1346 	1347 	1348 	1350 	1351 	1352 	1353 	1354 	1355 	1356 	1357 
1358 	1359 	1360 	1361 	1362 	1363 	1364 	1365 	1366 	1367 	1368 
1369 	1370 	1388 	1389 	1390 	1393 	1396 	1397 	1398 		

## 18.2 Overview Embroidery motifs

### Editing embroidery motifs

Let your inspiration run free. A vast selection of embroidery motifs is at your disposal.













If you see one of the following pictograms below a number of the embroidery motif, you can find additional information at









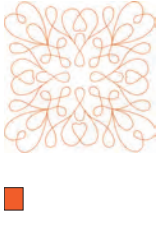

[www.bernina.com/7series](http://www.bernina.com/7series).

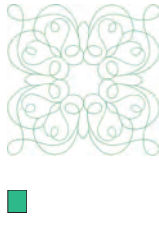

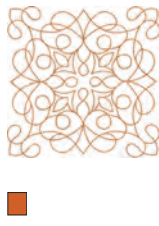



	Detached point		CutWork Design (motif)
	Hole embroidery		PaintWork Design (motif)
	Fringe embroidery		CrystalWork Design (motif)
	Appliqué		

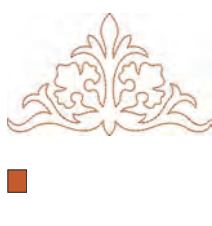

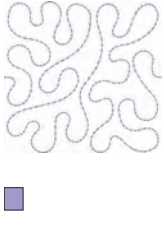
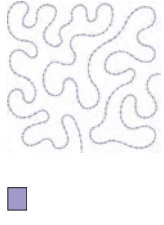

### Quilt motifs

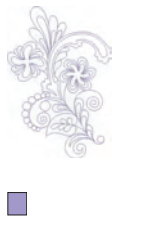







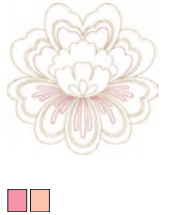

















No.	Embroidery motif Colors	Width x Height in mm	No.	Embroidery motif Colors	Width x Height in mm
12380-22		110.6 60.9	12380-43		123.5 123.5
12380-30		89.2 96.3	12380-04		83.1 89.8
12380-08		89.2 89.1	12380-09		111.6 61.6
12380-10		152.0 356.7	BD800		127.3 122.4
BD801		122.2 124.2	BD804		122.9 123.6
BD796		47.2 174.5	BD837		123.6 123.6











No.	Embroidery motif Colors	Width x Height in mm	No.	Embroidery motif Colors	Width x Height in mm
BD285		99.8 99.7	BD288		96.3 96.0
BD292		94.8 95.1	BD289		95.0 94.7
BD299		94.5 95.0	BD308		95.0 94.4
BD413		97.1 97.2	BD554		109.9 109.9
BD553		113.8 121.1	BD567		107.9 108.2
BD394		97.0 96.8	BD412		89.4 53.2

No.	Embroidery motif Colors	Width x Height in mm	No.	Embroidery motif Colors	Width x Height in mm
BD501		63.5 61.1	BD502		61.5 60.7
BD513		63.5 63.4	BD514		63.5 62.9
BD562		63.9 126.0	BD568		109.5 160.3
BD563		89.7 89.6	BD569		120.6 120.6









### Embellishment























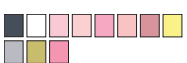

No.	Embroidery motif Colors	Width x Height in mm	No.	Embroidery motif Colors	Width x Height in mm
82007-11 		111.7 94.2	82007-44		114.0 114.8



No.	Embroidery motif Colors	Width x Height in mm	No.	Embroidery motif Colors	Width x Height in mm
82006-30 	 	99.9 174.6	NB251	 	71.6 103.3
BE790405	 	125.9 185.4	FB126	 	86.9 102.2
BE790407	 	199.9 270.9	BE790502	 	59.9 58.2
21003-26 	 	123.0 124.1	NB403	 	78.1 78.3
NB373	 	121.4 176.8	NB442	 	55.6 58.4
NB481	 	123.4 67.6	NB749	 	126.5 262.8

No.	Embroidery motif Colors	Width x Height in mm	No.	Embroidery motif Colors	Width x Height in mm
NA959 	 	75.6 103.7	FB106	 	128.1 92.6
NB002	 	59.3 35.1	FQ870	 	122.1 105.1
WS655	 	116.5 222.3			

























## Flowers





























No.	Embroidery motif Colors	Width x Height in mm	No.	Embroidery motif Colors	Width x Height in mm
82006-07	 	123.7 165.6	21006-02	 	114.5 135.5
80001-23	 	85.0 101.6	12457-06	 	106.3 172.3

No.	Embroidery motif Colors	Width x Height in mm	No.	Embroidery motif Colors	Width x Height in mm
12457-13	 	113.1 130.3	21009-21	 	64.9 107.7
BE790408	 	58.3 89.7	BE790401	 	205.7 242.0
21002-02	 	109.7 160.0	21012-04 	 	123.1 123.9
FB492	 	86.8 293.2	FP246	 	65.6 61.8
FP814	 	88 84.4	FQ562	 	90.3 156.3
FQ722	 	80.0 90.6	FQ733	 	66.5 66.5

No.	Embroidery motif Colors	Width x Height in mm	No.	Embroidery motif Colors	Width x Height in mm
FQ801	 	46.0 112.5	NB209	 	90.0 89.9











### Children













No.	Embroidery motif Colors	Width x height in mm	No.	Embroidery motif Colors	Width x height in mm
BE790307 	 	141.5 126.9	BE790311 	 	114.1 152.5
BE790305 	 	118.3 145.5	BE790306 	 	132.1 151.4
BE790308 	 	191.3 219.6	BE790309 	 	87.5 149.8
BE790310 	 	137.8 136.0	BE790312 	 	122.0 133.1

No.	Embroidery motif Colors	Width x height in mm	No.	Embroidery motif Colors	Width x height in mm
BE790313 	 	98.9 102.3	CK511	 	76.2 64.6
CM193 	 	106.7 127.4	CK667 	 	99.8 82.3
CK738	 	89.1 85.7	CK970	 	84.8 81.6
CM147	 	55.0 99.6	CM220 	 	71.5 71.8
CM348	 	119.0 167.1	CM362 	 	120.6 113.0
CM376	 	100.3 97.5	NB193	 	113.3 96.2























### Borders and Lace

No.	Embroidery motif Colors	Width x Height in mm	No.	Embroidery motif Colors	Width x Height in mm
21013-29	 ■	40.2 152.0	BE110415	 ■ ■ ■	43.7 172.4
FA981	 ■	35.1 142.3	21002-21	 ■	21.6 150.9
21009-29	 ■	31.9 152.6	82005-40	 ■	26.0 239.4
BE790702	 ■	73.0 190.5	NA914	 ■ ■ ■	120.3 18.8
NB520	 ■ ■	26.3 175.9	HG177	 ■ ■ ■ ■ ■ ■ ■	50.0 158.6

No.	Embroidery motif Colors	Width x Height in mm	No.	Embroidery motif Colors	Width x Height in mm
CM473	 	31.8 209.6	FB436	 	132.8 29.2NX
NX696	 	91.2 90.7	HG341	 	63.8 63.7
NX957	 	97.9 88.1	FB461 	 	121.7 121.6





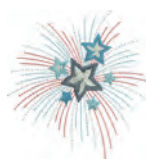





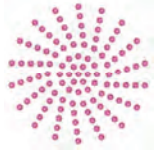







### Seasons

No.	Embroidery motif Colors	Width x Height in mm	No.	Embroidery motif Colors	Width x Height in mm
12433-05 	 	83.4 124.4	12417-04	 	84.3 97.1
BE790303	 	69.5 70.1	BE790301	 	127.2 89.0

No.	Embroidery motif Colors	Width x Height in mm	No.	Embroidery motif Colors	Width x Height in mm
GNNF80834	 Green, Pink, Purple, Blue, Black	95.2 78.8	HE962	 Red	120.5 135.2
12421-11	 Orange, Black, White	39.9 43.6	12421-37	 Black	67.4 61.0
12421-03	 Black, White, Grey	45.8 48.3	CM287	 Grey, Brown, Pink, Black, Green, Yellow, Red, White	90.4 117.2
CM426	 Light Green, Red, White	45.8 96.0	FQ749	 Orange, Green	77.6 94.8
HE919	 Light Blue, Blue	89.1 69.2	HG053	 Green, Red	122.1 121.8
HG319	 Green	88.6 151.5	HG460	 Light Blue, Red, Blue, Dark Blue, Grey	91.8 98.1



### DesignWorks design

No.	Embroidery motif Colors	Width x Height in mm	No.	Embroidery motif Colors	Width x Height in mm
DW11 		70 x 71	BE790901 		181 x 252
BE790903 		181 x 292	BE790905 		104 x 227
BE790906 		192 x 195	BE790909 		167 x 322
DW07 		114 x 152	DW05 		105 x 94
DW10 		184 x 184	DW08 		100 x 206

## Index

### A

Activating the audio signals	61
Activating the bobbin thread indicator	61
Activating the upper thread indicator	61
Adjusting the brightness of the display	62
Adjusting the presser foot pressure	41
Adjusting the presser position via the knee lifter of the Free Hand System	40
Adjusting the sewing light	63
Adjusting the upper thread tension	52
Alphabets	108
Altering the embroidery motif size disproportionately	154
Altering the embroidery motif size proportionally	153
Altering the stitch density	155
Attaching the embroidery module	138
Attaching the hoop	146
Attaching the knee lifter	35
Attaching the stitch plate	142

### B

Back to default settings	63
BERNINA Dual Feed	72
Buttonholes	110

### C

Calibrating the Buttonhole foot No. 3A	65
Calibrating the display	63
Calibrating the hoop	57
Calling up Help	70
Calling up the Creative Consultant	70
Calling up the Tutorial	70
Changing the needle	41
Changing the presser foot	40
Changing the stitch plate	43
Checking the firmware version	68
Child safety feature	70
Cleaning the feed dog	169
Cleaning the hook	169
Cleaning the thread catcher	66
Combi mode	78
Connecting the foot control	34

Cord	113
------	-----

### D

Decorative stitches	103
Dispose of the machine	179

### E

Embroidery file format	135
Embroidery test	135
Environmental Protection	16
Error messages	175

### F

Fault	172
-------	-----

### I

Inserting the embroidery needle	140
Introduction	17

### K

Key to signs	18
--------------	----

### L

Lubricating the hook	170
Lubricating the machine	67

### M

Maintenance and cleaning	169
Moving the hoop to the back	147
Moving the module for the sewing mode	147

### N

Needle stop up/down (permanent)	43
Needle, Thread, Fabric	29
Needles, Threads	32

### O

Overview Embroidery module	131
Overview Embroidery motifs	184
Overview stitch patterns	181

### P

Pintucks	106
----------	-----

Placing the spool disc	37
Power save mode	70
Practical stitches	87
Programming the securing stitches	52

## Q

---

Quilting	123
----------	-----

## R

---

Raising/Lowering the needle	36
Registering details of the dealer	69
Regulating the speed	73, 151

## S

---

Safety instructions	14
Saving Service data	69
Selecting a language	62
Selecting a stitch pattern	71
Selecting an embroidery motif	139
Selecting personal settings	60
Sewing a test sample	115
Storing the machine	179

## T

---

Technical data	180
Threading the bobbin thread	49
Threading the double needle	47
Threading the triple needle	48
Threading the upper thread	44

## U

---

Updating the machine Firmware	65
Using a spool net	37
Using eco mode	70

## V

---

Virtual positioning of the embroidery hoop	148
--	-----

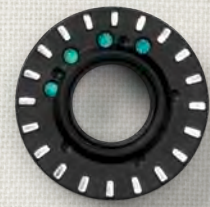

in partnership with

*Mettler*<sup>®</sup>

made to create

**BERNINA**