



BERNINA 880 PLUS
ANNIVERSARY EDITION

125
YEARS



made to create

BERNINA

LOOKING FOR A NEW SEWING PROJECT?

You can find what you want in "inspiration", our sewing magazine. Thanks to great sewing patterns and detailed sewing instructions, every project succeeds right away.

Inspiration magazine is available in German, English, French and Dutch



* Not available in all countries.

Dear BERNINA Customer



Congratulations! You have decided on BERNINA and therefore on a product which will delight you for years. For more than 100 years our family company has attached greatest importance to satisfied customers. As for me, it is a matter of personal concern to offer you Swiss development and precision at the height of perfection, future-orientated sewing technology and a comprehensive customer service.

The BERNINA 880 PLUS is our top model - and during its development not only was focus placed on technique and ease of use but also the design of the product was well considered. After all we sell our products to creative people like you, who do not only appreciate high quality but also form and design. By means of the BERNINA sewing and embroidery system 880 PLUS, sewing and embroidering becomes faster, more intelligent, more constant, more creative and is even more fun.

Enjoy creative sewing, embroidering and quilting on your new BERNINA 880 PLUS and keep informed about the various accessories at www.bernina.com. On our homepage you will also find a lot of inspiring sewing instructions, to be downloaded for free.

Our highly trained BERNINA dealers will provide you with more information on service and maintenance offers.

I wish you lots of pleasure and many creative hours with your new BERNINA.

H.P. Ueltschi
Owner
BERNINA International AG
CH-8266 Steckborn
www.bernina.com

IMPORTANT SAFETY INSTRUCTIONS

IMPORTANT INFORMATION

When using an electrical appliance, basic safety precautions should always be followed, including the following:

Read all the instructions before using this sewing-/embroidery computer.

When the sewing-/embroidery computer is not in use, it should be disconnected from the electricity supply by removing the plug from the outlet.

DANGER!

To reduce the risk of electrical shock:

1. The sewing-/embroidery computer should never be left unattended when plugged in.
2. Always unplug this sewing-/embroidery computer from the electrical outlet immediately after using and before cleaning.
3. LED Radiation – Do not view directly with optical instruments. Class 1M LED product.

WARNING!

To reduce the risk of burns, fire, electric shock or injury to persons:

1. Use this sewing-/embroidery computer only for purposes as described in this manual. Use only attachments, accessories and parts recommended by the manufacturer.
2. Do not allow this sewing-/embroidery computer to be used as a toy. Close attention is necessary when this sewing-/embroidery computer is used by or near children and infirm persons. The sewing-/embroidery computer is not intended for use by persons (including children) with reduced physical, sensory or mental capabilities or lack of experience and knowledge, unless they have been given supervision or instruction concerning use of the sewing-/embroidery computer by a person responsible for their safety. To ensure children do not play with

the sewing-/embroidery computer they must be supervised.

3. Never operate this sewing-/embroidery computer if:
 - it has a damaged cord or plug
 - it is not working properly
 - it has been dropped or damaged
 - it has fallen into waterReturn the sewing-/embroidery computer to your local authorized BERNINA dealer for examination or repair.
4. Never operate the sewing-/embroidery computer with any air openings blocked. Keep ventilation openings of the sewing-/embroidery computer free from the accumulation of lint, dust and loose cloth.
5. Keep fingers away from all moving parts. Special care is required around the sewing needle.
6. Never insert any objects into any openings on the sewing-/embroidery computer.
7. Do not use the sewing-/embroidery computer outdoors.
8. Do not operate the sewing-/embroidery computer where aerosol products (sprays) or oxygen are being used or where oxygen is being administered.
9. Do not pull or push the fabric while stitching. This may deflect the needle, causing it to break.
10. Do not use bent needles.
11. Always use the original BERNINA stitch plate. The wrong stitch plate can cause needle breakage.
12. To disconnect, turn power switch to «0» (off), then remove the plug from the outlet. Do not unplug by pulling the cord, instead grasp the plug to pull it from the outlet.
13. Turn power switch to «0» (off) when making any adjustments in the needle area, such as changing the needle or the presser foot, etc.
14. Always unplug the sewing-/embroidery computer from the electrical outlet when carrying out cleaning or maintenance work or any other user servicing adjustments mentioned in this manual.
15. This sewing-/embroidery computer is provided with double insulation (except USA and Canada). Use only identical replacement parts. See instructions for servicing of double-insulated products.

SERVICING DOUBLE-INSULATED PRODUCTS

In a double-insulated product two systems of insulation are provided instead of grounding. No grounding means is provided on a double-insulated product, nor should a means for grounding be added to the product. Servicing a double-insulated product requires extreme care and knowledge of the system and should be done only by qualified service personnel. Replacement parts for a double-insulated product must be identical to the original parts in the product. A double-insulated product is marked with the words: «DOUBLE INSULATION» or «DOUBLE INSULATED».

The symbol  may also be marked on the product.

DISCLAIMER

No liability will be assumed for any possible damage which arises from misuse of this sewing-/embroidery computer.

This sewing-/embroidery computer is intended for household use only.

This sewing-/embroidery computer meets the European Standard 2004/108/EC concerning the electromagnetic tolerance.

SAVE THESE INSTRUCTIONS!



Please find the latest version of your instruction manual at www.bernina.com

Environmental Protection



BERNINA is committed to the protection of the environment. We strive to minimize the environmental impact of our products by continuously improving product design and our technology of manufacturing.

When your sewing computer won't be used anymore, dispose this product in an environmentally responsible way according to the national directive. Do not throw away this product with your household waste. In case of doubt, please contact your BERNINA dealer.



If the sewing computer is stored in a cold room, it should be brought to a warm room about one hour before use.

Contents

IMPORTANT SAFETY INSTRUCTIONS	2	Threading Double/Triple Needle	26
Environmental Protection	3	• Threading Double Needle	26
Key to Signs	10	• Working with the Double needle	26
Breadcrumb navigation	10	• Triple Needle	26
Formatting the USB stick	10	• Changing the thread	26
Accessory Sewing	11	Changing the presser foot	27
Standard Accessories	11	• Removing the presser foot	27
Presser feet	12	• Attaching the presser foot	27
Accessory box free standing	13	Stitch plate	27
Bobbin	13	• Marks on the stitch plate	27
Overview sewing computer	14	• Removing the Stitch Plate	27
Front view	14	• Replacing the Stitch Plate	27
Detail view	14	Thread-Guide-and-Lubricating Unit	28
Important Sewing information	16	• As a thread-guide eyelet (Fig. 1)	28
Thread	16	• As a thread lubricator (Fig. 2)	28
Needle, thread and fabric	16	• Assembly	28
Needles, threads	17	• Various Options of Application	29
• Correct needle/Thread combination	17	Radial Thread Guide	29
• Too thin thread or too thick needle	17	• Application	29
• Too thick thread or too thin needle	17	Upper thread tension	30
Overview needles	18	• Altering upper thread tension	30
Sewing preparation	19	• Saving the upper thread tension	30
Battery	19	• Back to basic settings	30
Power Switch/Power Cable	19	Lower Thread Tension	31
Magnetic holder for Touchscreen pen	19	Security Program	32
Foot control	20	• Display	32
Slide-on table	20	• Selecting the needle	32
• Seam guide	20	• Selecting the stitch plate	32
Presser foot lifter	21	• Saving	32
Pivotable Triple Spool Holder	21	Needle Chart	32
Winding the Bobbin	22	• Selecting needle	32
• Preparation	22	Selecting a Presser Foot	33
• Winding the Bobbin	22	• Display	33
• Manual mode	22	• Optional presser feet	33
• Interrupting the winding process	22	• Saving	33
• Continuing the winding process	22	• Return to basic settings	33
Removing the Bobbin	23	Altering presser foot pressure	34
• Removing the Bobbin	23	• When sewing thick material, e.g. quilting	34
• Inserting the Bobbin	23	• Saving presser foot pressure	34
• Threading lower thread	23	• Resetting the basic setting	34
• Thread cutter lower thread	23	Feed dog position	34
• Check the threading path	23	• Feed dog position down	34
Threading the Upper Thread	24	• Feed dog position up	34
• Automatic	24	Bobbin filling	34
• Manual	24	Alarm	35
Changing the needle	25	• Setting the time of the alarm	35
• Removing the needle	25	• Individual alarm message	35
• Inserting the needle	25	• Deleting an alarm message	35
		• Corrections	35
		• Alarm Display	35
		Feed dog and Fabric feed	36
		Functions	38
		Overview «Function»-buttons	38
		• «Start/Stop»-button	38
		• «Quick reverse»/«Permanent reverse sewing»-button	38
		• Slide speed control	38
		• «Automatic threader»-button	38

• Programmable «Pattern end-/Securing»-button	38	• Deleting Welcome text	60
• «Needle stop»-button	39	• Corrections	60
• «Automatic Securing Program»-button	39	Monitoring	60
• «Presser foot position»-button	39	• Upper-/Lower thread indicator/Thread knots	60
• «Automatic thread cutter»-button	39	Altering the acoustic signals	61
• Stitch width and Stitch length Knobs (Multifunction)	39	• Selecting Stitch Pattern/Function/BSR	61
• «Needle position»-buttons	39	Sewing computer settings	61
• Needle stop position up and		• Language selection	61
«Quick reverse»-button	39	• Display settings	62
• Needle stop position down and «Quick reverse»-		• Display Calibration	62
button	39	• Basic setting	63
Display	40	Cleaning/Update	64
Overview Main Display	40	• Calibrating Buttonhole foot No. 3A	64
• System settings	40	• Updating the sewing-/embroidery computer	64
• External Functions/Views	40	• Cleaning the thread clamp/Thread catcher	65
• Menu Selection	40	• Cleaning the thread catcher	65
• Selection	41	• Lubricating the machine	66
• Stitch Pattern Area	41	• Packing position	66
• Stitch Pattern Display	41	• Setting the clock	66
Functions - Display	42	Information	67
Sewing Functions Overview	42	• Version	67
Scrolling Functions	42	• Dealer details	67
General Functions	42	• Service data	67
Overview Functions Buttonholes	46	• ID Number	68
Overview Functions Alphabets	47	• UPGRADE	68
Overview Functions Combi mode	48	Tutorial	69
Setup-Program	52	Overview Tutorial	69
Overview «Setup»-Display	52	Creative Consultant	70
Sewing settings	53	Overview Creative Consultant	70
• Altering Upper thread tension	53	Overview Sewing techniques/Recommendations	70
• Sewing speed control	53	Leaving the Creative consultant	70
• Securing stitches when starting to sew	53	Help Program	71
• Programming «Function»-buttons/«Function»-icon	54	• Stitch patterns	71
• Automatic securing program	54	• Functions	71
• Automatic thread cutter	54	• Leaving the Help Program	71
• Raising the presser foot	54	Balance	72
• Programming «Securing»-button	54	Practical and decorative stitches, alphabets	72
• Hover position of the presser foot	54	• Practical and decorative stitches	72
• Automatic thread cutter and securing stitches	55	• Corrections	72
• Programming «Quick reverse»-button	55	• Sideways-motion patterns	72
• Presser foot position with needle stop down	55	• Vertical corrections	73
• Programming the foot control	56	• Horizontal corrections	73
• Programming securing stitches	56	• Back to basic settings	73
• Automatic thread cutter	56	BERNINA Dual Transport	73
• Raising the presser foot	56	• Balance BERNINA Dual Transport	73
Embroidery settings	57	• Back to basic setting	73
• Centering or opening embroidery motifs in the		eco description	74
original position	57	• Activating eco	74
• Calibrating the embroidery hoop	57	• Deactivating eco	74
• Fabric Thickness	58		
• Function thread removal on/off	58		
• Programming the securing stitches	58		
• Adjusting the thread cut	59		
• Changing the measuring unit	59		
Personal settings	60		
• Welcome text	60		

Practical stitches	76	Altering the balance	99
Overview Practical stitches	76	• Balance with direct entry length buttonholes	99
Selecting stitch pattern	78	• Balance with direct entry length keyhole or round buttonholes	99
• Direct-Option 1	78	• Balance for manual keyhole or round buttonhole	99
• Direct-Option 2	78	• Balance for manual standard buttonhole	99
• By stitch number	78	• Balance for stitch counter buttonhole	99
• Cancelling	78	• Clear Balance	99
Customizing stitch patterns individually	79	Programming buttonholes	100
Temporary Altered Stitch Memory	79	Standard and stretch buttonhole with auto-length, automatically	100
Personal memory permanent	80	Automatic with Direct Entry Length	101
Altering stitch width and stitch length	81	Automatic with Button measuring	101
Application Examples of Practical Stitches	82	Automatic round and keyhole buttonhole	102
Straight stitch	82	Heirloom Buttonhole	104
Triple Straight Stitch	82	Stitch Counter Buttonhole	104
Triple Zig-zag	83	Buttonhole in Long Term Memory	105
Zipper	84	7- or 5-step Buttonhole, manually	107
Manual darning	85	Button sew-on program	108
Automatic Darning	86	Eyelet Program	109
Reinforced darning, automatic	87	Decorative Stitches	110
Reinforced Darning program	87	Overview Decorative Stitches	110
Finishing Edges	88	Application	110
Double overlock	88	Tapering	111
Topstitching edges	89	• Altering angle	111
Blind Hems	90	• Tapering Functions	112
Visible Hem	90	Stitch Designer	114
Securing Program	91	Stitch designer functions	114
Basting Stitch	91	Creating or editing stitch design	116
Flat joining seam	92	• Opening the Stitch Designer	116
Height Compensation of uneven layers	93	• Creating a stitch design using the guides	116
Sewing Corners	93	• Creating stitch designs using screen dots	116
Buttonholes	94	• Free hand drawing	116
Overview Buttonholes	94	• Selecting and moving a single point	117
Important information	96	• Moving several stitches	117
• Marking the length of manual buttonholes	96	• Inserting a point	117
• Marking the length of automatic buttonholes	96	• Duplicating	117
• Marking the length of keyhole buttonholes	96	• Reversing the stitch sequence	118
• Test sample	96	• Sewing stitch designs	118
• Adjusting the bead width	96	Application examples of Decorative stitches	119
• Altering the stitch length	96	Cross Stitch	119
Stabilizer	97	Pintucks	120
Cord	98	Bobbin-Play Sewing	122
• Ideal cords	98	Quilt Stitches	123
• Cord with the automatic Buttonhole foot No. 3A	98	Overview Quilt Stitches	123
• Cord with the Buttonhole foot No. 3C (optional accessory)	98	Application examples of Quilt stitches	124
• Fixing the cord	98	Handlook quilt stitch	124
• Cutting buttonholes open with the seam ripper	98	Free-motion quilting	125
• Cutting open buttonholes with the buttonhole cutter (optional accessory)	98		

BSR (BERNINA Stitch Regulator)	126	Combi Mode	143
Quilting with BSR	126	Creating Stitch pattern combinations	143
• BSR-Function	126	• Programming and saving	143
• BSR function with straight stitch No. 1	126	Deleting Stitch patterns	144
• BSR function with zig-zag No. 2	126	• Deleting individual stitches	144
• Two different BSR modes	126	• Deleting entire combination	144
• Preparation	127	Overview Combination	144
• Remove presser foot sole	127	Opening a saved combination	145
• Attaching the presser foot sole	127	Correcting a stitch pattern combination	146
Functions in the BSR mode	128	• Inserting a stitch pattern	146
• Needle stop down (standard)	128	• Altering stitch patterns	146
• Needle stop up	128	• Adjusting the length within the combination	146
• Raising or lowering the needle	128	• Adjusting the width within the combination	147
• Securing with «Start/Stop»-button (only Mode 1)	128	• Mirroring complete combinations	147
• Securing function (only Mode 2)	128	• Combination subdivider 1	147
• Free motion quilting (only Mode 2)	128	• Combination Subdivider 2	147
• Free motion quilting without BSR activation	128	• Moving individual stitch patterns in a combination	148
• Beeper (audio signal) activation/deactivation	129	• Moving multiple stitch patterns in a combination	148
• Selecting sound for BSR in the Setup Program	129	• Sewing individual stitch patterns of a combination	148
• Selecting sound for BSR in the «BSR»-Display	129	in any direction	148
• Activating BSR Sewing Function	130	• Sewing the complete combination in any direction	148
• Deactivating BSR Sewing Function by using	130	Stitch pattern combination	149
«Start/Stop»-button	130	• Overwriting	149
• BSR Function deactivation	130	• Deleting	149
BERNINA Dual Feed	132	History	150
• Presser Feet Selection	132	Accessory Embroidery	151
• Switching on BERNINA Dual Feed	132	Standard Accessory	151
• Switching off BERNINA Dual Feed	132	Embroidery module	152
Fabrics	133	Detail view	152
Alphabets	134	Important Embroidery information	153
Overview Alphabets	134	Embroidery threads	153
• Lettering	134	Lower threads	153
• Perfect stitch formation	134	Choosing the embroidery motif	154
Combining characters	135	Embroidery test	154
• Selecting the next letter	135	Scaling/Sizing motifs	154
• Large view of the Display	135	Selecting the embroidery file format	154
• Corrections	135	Different stitch types	155
Correcting the combination	136	• Underlay stitches	155
• Inserting character	136	• Satin stitch	155
• Deleting Letters	136	• Step stitch	155
Alphabet in combination with functions	136	• Connecting stitches	155
• Selecting lower case letters	136	Preparing for embroidery	156
• Altering font size	136	Attaching the Module	156
Monograms	137	Embroidery foot/Embroidery needle	156
• Monogram Sizes	138	Straight-/CutWork stitch plate	157
• Balance	138	Threading lower thread	157
Personal Program	139	• Checking the thread position	157
Creating a personal Display	139	Thread-up command	157
Preparing stitch patterns	139		
• Programming/Saving first stitch pattern	139		
• Programming/Saving second stitch pattern	140		
• Stitch pattern selection in the Personal program	140		
• Personal Display	140		
Altering/Overwriting stitch patterns	141		
Deleting stitch patterns	142		

Embroidery hoop	158	My Designs	178
• Center determination	158	• Motif Overview	178
• Using the embroidery hoop	158		
• Embroidery template	158	Motifs in combination with functions	179
• Hooping the material	158	Moving the motif	179
Stabilizer	159	Rotating the motif	179
Stabilizers	159	Altering the embroidery motif size proportionally	179
Adhesive Spray	159	Altering the embroidery motif size disproportionately	180
Iron-on interfacing	160	Mirror motifs	180
• Paper-backed adhesive stabilizer	160	Pinpoint placement	180
• Water soluble stabilizer	160	Grouping embroidery motifs	182
Functions	161	Changing the sequence within an embroidery motif combination	182
Overview «Function»-buttons embroidery computer	161	Undoing entries	183
• «Start/Stop»-button	161	Select hoop	184
• «Automatic thread cutter»-button	161	• Motif Center	184
• «Presser foot position»-button	161	• Grid	184
• «Automatic threading»-button	161	Absolute Embroidery check	185
• Slide speed control	161	• Checking the motif size	185
• Stitch width and stitch length knob	161	Zoom	186
Overview Display	162	• Moving the motif	186
Entry to Embroidery mode	162	Motif size and embroidery time	186
Embroidery consultant	163	Endless Embroidery	187
Overview Embroidery consultant	163	• Increase/decrease number of motifs	187
Overview Material	163	• Increase/decrease spacing	187
Overview Embroidery techniques/recommendations	163	• Fit to hoop	187
Embroidery Alphabet	164	Free arm embroidering	189
BERNINA Embroidery motifs	166	Shape designer	190
BERNINA Stitch patterns	166	• Selecting the formation	190
My Designs	167	• Increasing/reducing the number of motifs	190
Embroidery motif from USB stick	167	• Altering the size of the formation shape	190
«Edit»-Display	168	• Rotating the motifs	191
Overview «Edit»-Display	170	• Mirroring motifs	191
Scrolling Functions	170	• Embroidering the motifs	191
General Functions	170	• Closing the «Shape designer»-Display	191
Overview Embroidery menu	174	Combinations	192
Overview Selection menu	175	Creating combinations	192
Overview Color Display	176	• Adding a motif	192
Motifs	177	• Duplicating a motif	192
Selecting a motif	177	• Duplicating a combination	192
Alphabets	177	Lettering	193
• Selecting alphabet	177	• Combining	193
• Entering/Correcting lettering	177	• Positioning	193
• Deleting lettering	177	• Further text lines	193
• Corrections	177	Lettering and Embroidery motifs	194
BERNINA embroidery motifs	178	• Combining	194
• Motif Overview	178	• Adjusting text to motif	194
Stitch patterns	178	• Lettering Manipulation	194
• Stitch pattern overview	178	• Deleting stitch patterns/individual characters/text	194
		Change stitch type	195
		Fill stitch types	196
		• Changing stitch type	196
		• Altering stitch density	196

Motif colors	197	Troubleshooting	212
• Reallocating motif colors	197	Overview Stitch patterns	221
• Changing the colors of the motif via the color wheel	197	Practical stitches	221
• Adjusting the brightness of the colors	198	Buttonholes	221
• Changing the thread brand	198	Decorative stitches	221
• Embroidering the motif by color	199	Quilt stitches	225
• Reducing color changes	199	Alphabets	227
• Embroidering motifs in one color	199	Overview Motifs	236
• Embroidering lettering in multi colors	199	Diane Gaudynski	236
• Embroidering lettering in one color	199	Exotic Rainforest	238
Basting	200	Floral Etchings	241
• Deactivating basting	200	Projects	243
Endless Embroidery	200	Shaping designs	245
Importing stitch patterns from the sewing mode	201	Monograms	249
• Selecting stitch patterns in the sewing mode	201	DesignWorks designs	251
• Selecting stitch patterns in the embroidery mode	201	BC Embellishment	252
Saving the motif	202	BC Quilting	254
Memory Embroidery computer	202	BC Borders	256
USB stick	202	BC Flowers	258
Overwriting motifs	203	BC Seasons	260
Deleting saved single motif	204	BC Children	261
• Cancelling delete	204	BC Hobby	263
Deleting all saved motifs	205	BC Animals	264
• Cancelling delete	205	BC Flowers Outline	265
Starting to embroider	206	BC Switzerland	266
Select hoop	206	Projects	267
• Attaching the embroidery hoop	206	Charming Monograms	268
• Attaching the hoop to the embroidery arm	206	Homedeco	270
• Removing the hoop	206	Alphabets	272
Embroidery menu	207	Index	274
Embroidering using the «Start/Stop/hover»-button	207		
• Interrupting the process	207		
• Completing the color	207		
• Color change	207		
• «Embroidery»-Display	207		
• Embroidery speed	207		
• End of embroidery	208		
Embroidering via foot control	208		
• Interrupting the process	208		
• Completing the color	208		
• Color change	208		
• «Embroidery»-Display	208		
Thread breakage when embroidering	209		
Upper or lower thread breaks	209		
Embroidery sequence control when thread breaks	209		
• Returning to original position	209		
• Resuming embroidery	209		
Cleaning	210		
• Exchanging the battery	211		

Key to Signs

 **DANGER!**
Very important!
Risk of injury!

ATTENTION!
Very important!
Risk of damage!

 Tips!

Breadcrumb navigation

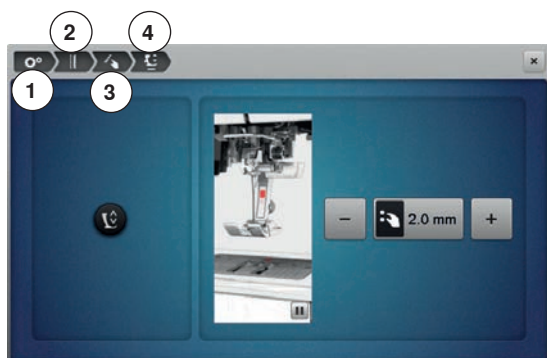

- 1 Setup program is selected
 - 2 Sewing settings are selected
 - 3 Programming «Function»-button/«Function»-icon is selected
 - 4 Programming hovering position of the presser foot is selected
- having selected the corresponding icon (as for this example 1-3) the desired display opens

Formatting the USB stick

USB stick must be inserted into the PC and be formatted as FAT 32 before use.

All rights reserved

For technical and product improvement reasons, the sewing computer's features, parts and accessory are subject to unannounced changes and alterations at any time. The accessory included can differ from country to country.

Accessory Sewing

Standard Accessories



- 1 Presser foot lifter
- 2 Foot control
- 3 Soft Cover with pocket
- 4 Accessory box
- 5 Power cable
- 6 Seam guide for slide-on table
- 7 Straight-/CutWork stitch plate
- 8 Slide-on table



- 9 Bobbins (one of them in the sewing computer)
- 10 Adjustable guides
- 11 Wire threader for threading cording for bobbin play
- 12 Tweezers
- 13 2 nets
- 14 Cording attachment
- 15 Small screwdriver, gray
- 16 Magnifying glass adapter/Spool Holder
- 17 Touchscreen pen
- 18 Seam ripper
- 19 Lint brush
- 20 Multifunction tool
- 21 Manual threader
- 22 Spool disc small
- 23 Holder for king-size spools, cone holder
- 24 Height compensating tool
- 25 Needle pack 130/705H
- 26 Lubricator
- 27 Monitoring mirror
- 28 USB stick
- 29 Hook cleaning tool
- 30 Thread-Guide-and-Lubricating Unit

Presser feet



- 1 No. 1C Reverse pattern foot
- 2 No. 1D Reverse pattern foot
- 3 No. 2A Overlock foot
- 4 No. 3A Automatic buttonhole foot with slide



- 5 No. 3C Buttonhole foot
- 6 No. 4D Zipper foot
- 7 No. 5 Blind stitch foot
- 8 No. 18 Button sew-on foot



- 9 No. 20C Open embroidery foot
- 10 No. 40C Sideways motion foot
- 11 No. 42 BSR foot



- 12 No. 26 Embroidery foot



Visit www.bernina.com for more accessory information.

Accessory box free standing



- on the back of the box, pull both extensions out until they click into place

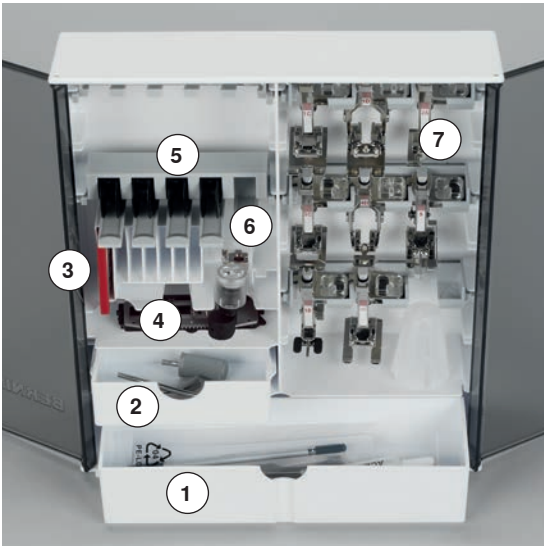

Storage example

Lay-out

The box is equipped as standard with one large **1** and one small **2** drawer as well as a compartment for bobbin holders **5** and presser feet **7**.

- to remove a bobbin, press the compartment holder **6** lightly
- buttonhole foot with slide No. 3A can be stored in the left compartment **4**
- store the needle package in the special compartment **3**

Bobbin

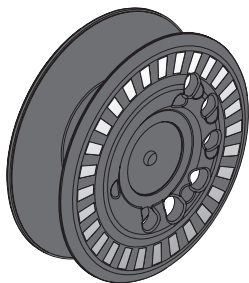

ATTENTION!

Treat the bobbins with care. Keep the white sensor surfaces free of scratches or stains to ensure correct functioning of the lower thread indicator. Store the bobbins in the respective compartment of the accessories box.

The bobbin of the B 880 PLUS, exclusive to BERNINA, supplies up to 40% more lower thread. If the bobbin is not inserted correctly, an error message is displayed.



You can preselect a bobbin fill of 25%, 50% or 100%.

Overview sewing computer

Front view



Detail view

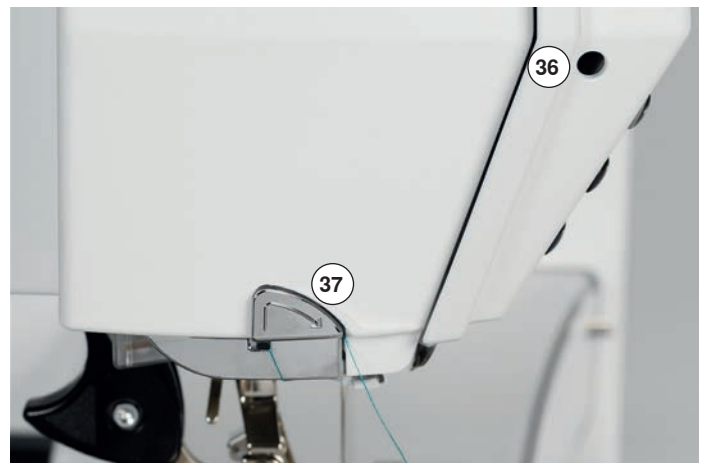
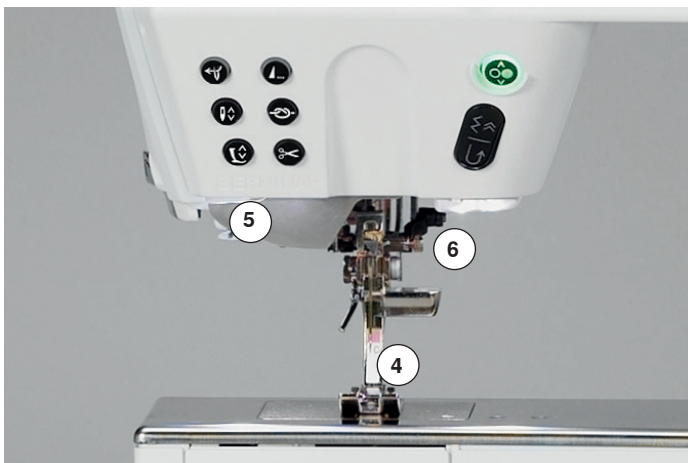



- | | |
|--|---|
| 1 Bobbin cover | 21 «Needle position»-buttons |
| 2 Stitch plate | 22 Magnetic holder for Touchscreen pen |
| 3 Special-accessories port | 23 Bobbin winder |
| 4 Presser foot | 24 Thread cutter for bobbin winder |
| 5 LED-Sewing light | 25 Threading slit |
| 6 Needle clamp | 26 Bobbin pre-tension |
| 7 «Quick reverse»-button | 27 Triple spool pin |
| 8 «Start/Stop»-button | 28 Telescope |
| 9 «Automatic thread cutter»-button | 29 Handwheel |
| 10 «Presser foot lift»-button | 30 USB-connection |
| 11 «Securing»-button | 31 PC-connection |
| 12 «Needle stop up/down»-button | 32 Foot control socket |
| 13 «Pattern end»-button | 33 Power switch On «I»/Off «0» |
| 14 «Automatic needle threader»-button | 34 Power plug socket |
| 15 Slide speed control | 35 Air vents |
| 16 Display | 36 Connection for Magnifying glass (optional accessory) |
| 17 Carrying handle | 37 Thread cutter on the headframe |
| 18 «Sewing support»-buttons | 38 Special-accessories port |
| • «Home»-button | 39 BSR-connection |
| • «Setup»-button | 40 BERNINA Dual Feed |
| • «Tutorial»-button | 41 Darning hoop connection |
| • «Creative-/Embroidery Consultant»-button | 42 Slide-on table socket |
| • «Help»-button | 43 Free Hand System connection |
| • «eco»-button | |
| • «clr»-button (clear) | |
| 19 Stitch width knob | |
| 20 Stitch length knob | |

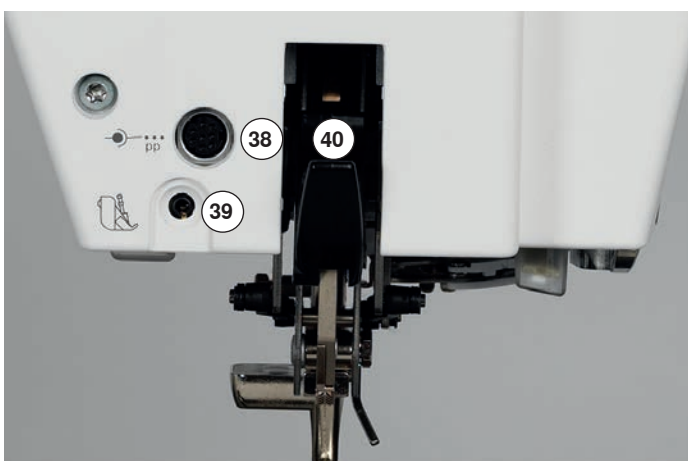

USA/Canada only: The sewing computer has a polarized plug (one blade wider than the other). To reduce the risk of electrical shock, this plug is intended to fit in a polarized outlet only one way. If the plug does not fit fully in the outlet, reverse the plug. If it still does not fit, contact a qualified electrician to install the proper outlet. Do not modify the plug in any way!

Important Sewing information

Thread

Be sure to select the appropriate thread type and weight for the fabric. For a perfect sewing result, thread and fabric quality play an important role. It is recommended to use quality brands.

Cotton threads

- cotton threads have the advantage of being a natural fiber and therefore are especially suitable for sewing cotton fabrics
- if cotton thread is mercerized, it has a slight sheen that is not lost with washing

Polyester threads

- polyester threads have a high tensile strength and are particularly colorfast
- polyester threads are more flexible and are recommended where a strong and elastic seam is required

Rayon threads

- rayon threads are made of natural fibers and have a brilliant sheen
- rayon threads are suitable for decorative stitches and achieve a more beautiful effect

Needle, thread and fabric

ATTENTION!

Check the needle condition.

As a guide: Replace the needle before starting a new sewing project. A defective needle does not only damage the sewing project but also the sewing computer.

Care must be taken when choosing needle and thread.

The correct needle size depends on the selected thread and fabric. The fabric weight and type determine the thread weight, needle size and point form.

Needles, threads

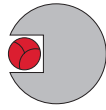

Correct needle/Thread combination

To sew optimally, the thread should travel smoothly down the long groove on the front of the needle.



Too thin thread or too thick needle

The thread has too much clearance in the long groove. Skipped stitches and damage to the thread can occur.

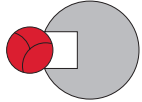

Too thick thread or too thin needle

The thread rubs on the edges of the long groove and can get jammed. This can result in thread breakage.



Guidelines





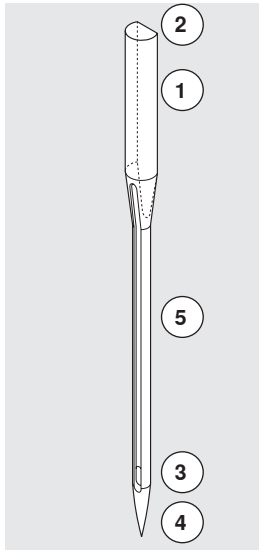



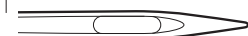

Material and thread	Needle size
Light weight materials: Fine thread (darning thread, embroidery thread)	70-75
Medium weight materials: Sewing thread	80-90
Heavy weight materials: Sewing thread (quilting thread, topstitching)	100, 110, 120

130/705 H-S/70

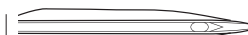

- 1 **130** Shank length
- 2 **705** Flat shank
- 3 **H** Needle scarf
- 4 **S** Needle point (here e.g. medium ball point)
- 5 **70** Needle size 0.7 mm

Overview needles

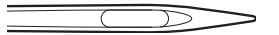
 <p>Universal 130/705 H/60-100</p> <p>Normal point, slightly rounded</p> <p>For nearly all natural and synthetic fabrics (woven and knitted)</p>	 <p>Metafil 130/705 H-MET/75-80 or H-SUK/90-100</p> <p>Large eye</p> <p>Sewing with metallic threads</p>
 <p>Jersey/Stretch 130/705 H-S, H-SES, H-SUK/70-90</p> <p>Ball point</p> <p>Jersey, knit and stretch material</p>	 <p>Cordonnet (Topstitching) 130/705 H-N/80-100</p> <p>Small ball point, long eye</p> <p>Topstitching with thick thread</p>
 <p>Leather 130/705 H-LL, H-LR/90-100</p> <p>With cutting point</p> <p>All types of leather, synthetic leather, plastic, sheeting</p>	 <p>Wing needle (Hemstitch needle) 130/705 HO/100-120</p> <p>Wide needle (wing)</p> <p>Hemstitching</p>
 <p>Jeans 130/705 H-J/80-110</p> <p>Very fine sharp point</p> <p>Heavy weight fabrics such as denim, canvas, overalls</p>	 <p>Double wing needle 130/705 H-ZWI-HO/100</p> <p>For special effects with hemstitch embroidery</p>
 <p>Microtex 130/705 H-M/60-90</p> <p>Especially fine sharp point</p> <p>Micro fiber fabrics and silk</p>	 <p>Double needle 130/705 H-ZWI/70-100</p> <p>Needle distance: 1.0/1.6/2.0/2.5/3.0/4.0/6.0/8.0</p> <p>Visible hems in stretch fabrics, pintucks, decorative sewing</p>
 <p>Quilting 130/705 H-Q/75-90</p> <p>Fine sharp point</p> <p>Straight and topstitching</p>	 <p>Triple needle 130/705 H-DRI/80</p> <p>Needle distance: 3.0</p> <p>Visible hems in stretch fabrics; Decorative sewing</p>
 <p>Embroidery 130/705 H-SUK/70-90</p> <p>Large eye, slight ball point</p> <p>Embroidery on all natural and synthetic fabrics</p>	

Sewing preparation

Battery

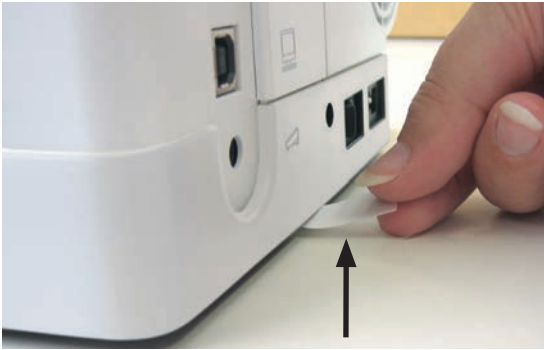

- please remove the protective sticker of the battery before taking the sewing computer in use

Power Switch/Power Cable



- 1 Power Switch**
The sewing computer is switched on («I») and off («0») with the power switch.
- I the sewing computer is switched on
0 the sewing computer is switched off
- 2 Power plug socket**
3 Foot control socket
4 PC-connection
5 USB-connection

Magnetic holder for Touchscreen pen



The Touchscreen pen can be stored easily and securely at the two magnets 1.

Foot control



Connecting the foot control

- unwind the cable
- plug the cable in the outlet 1
- unwind the cable to the desired length and slip into 4 or 5



Sewing speed control

Control the sewing speed by pressing the foot control 2.

Raising or lowering the needle

- sink the heel back 3 on the foot control
- ▶ the needle adjusts the position up/down

In the Setup-Program additional functions for the «back heel kicking» can be programmed.

Removing the foot control

- wind the cable around the reel
- plug cable into 6



USA/Canada only: Use only foot controller type LV-1 with sewing computer B 880 PLUS.

Slide-on table

The slide-on table increases sewing surface.

Attaching the slide-on table

- turn the handwheel or press the «Needle stop up/down»-button (see page 15)
- ▶ needle is raised
- press «Presser Foot lift»-button
- ▶ presser foot is raised
- slide table to the right, over the free arm until it engages

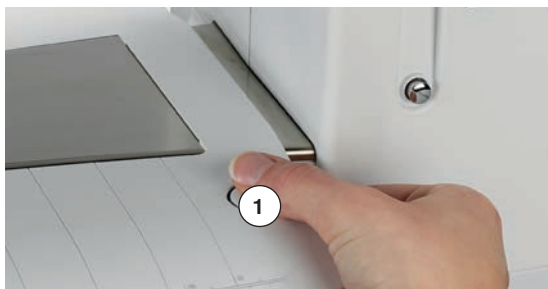

ATTENTION!

Remove the slide-on table only when bobbin cover is closed.

Removing the slide-on table

- raise the needle and presser foot
- press button 1 down
- pull slide-on table to the left



Seam guide

- press the release button and insert into the groove (underside of table) from left or right
- Can be moved over the entire table length.

Presser foot lifter



Raising or lowering presser foot via FHS.

Attaching the Free Hand System

- insert into the opening 1

Raising and lowering the presser foot

- with your knee, push lever to the right
- you should be able to operate the FHS with your knee in your normal sitting position
- ▶ the presser foot is raised; the feed dog is lowered simultaneously. The thread tension is released
- ▶ the feed dog is raised as soon as the first stitch is sewn



Your dealer can adjust the FHS if necessary.

Pivotable Triple Spool Holder

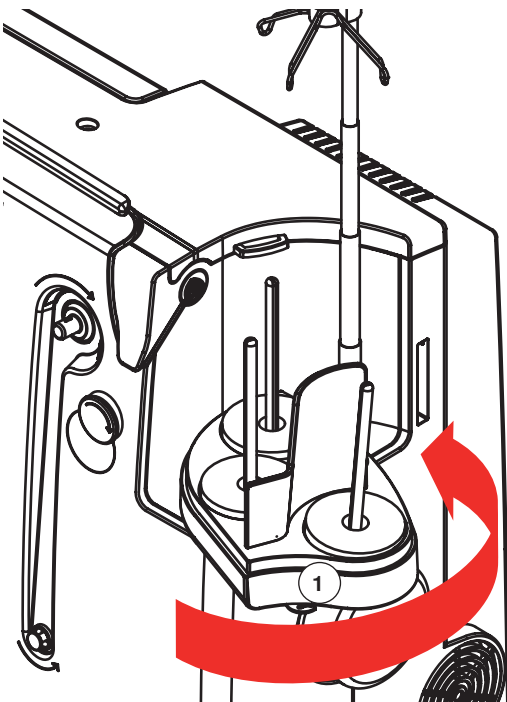

- remove spool-pin cover vertically upwards
- pull up the telescopic rod and ensure that all the parts snap into place
- swing spool pin to the right until it is engaged
- ▶ this ensures a good overall view and access to the spool pins
- ▶ eyelet 1 is used when winding a bobbin

Winding the Bobbin

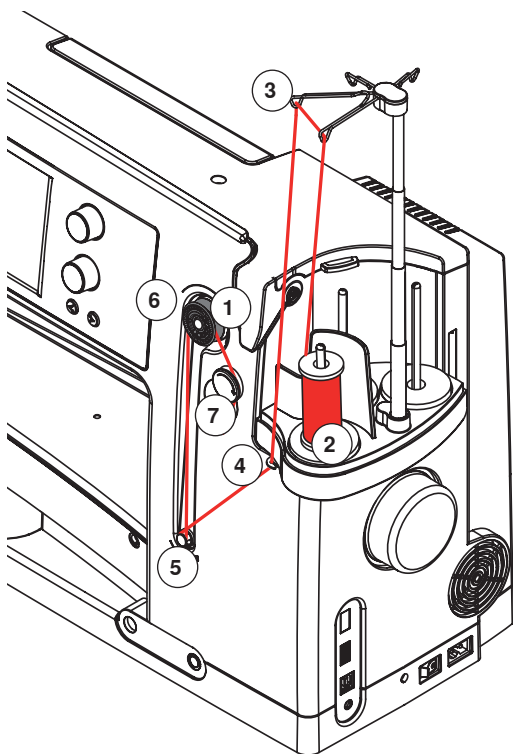

Preparation

- turn power switch on (to «I»)
- place empty bobbin on Pin 1, white mark in front
- ▶ the bobbin winding screen appears
- ▶ the amount of bobbin fill is recognized by the system and displayed by a bar above the selectable bobbin fill
- place thread spool on the front spool pin 2 and thread the respective guides 3 on the telescope

Winding the Bobbin

- hold thread with both hands, guide the thread in the thread guide on the swivel plate 4 in the direction of the arrows and around the bobbin pre-tension 5
- wind the thread one to two times around the empty bobbin 6 following the direction of the arrows and pull any excess thread in the direction of the arrows, cut off on the thread cutter 7
- select the bobbin filling, standard = 100%
- touch the green «Start»-icon 8
- adjust the winding speed via the «+»- or «-»-icon or the stitch width or stitch length knob
- ▶ winding process stops as soon as the selected fill percentage is reached
- remove the bobbin and pull the thread over the thread cutter
- ▶ the screen is closed



- touch the «i»-icon in the bobbin winder Display
- ▶ an animation how to wind the lower thread appears

Manual mode

- touch the «man»-icon
- ▶ the winder will run as long as the «Start»-icon is pressed



Interrupting the winding process

- the winding process can be interrupted while winding by touching the «Start»-icon 8 and the Display can be closed by touching the «Close»-icon top right

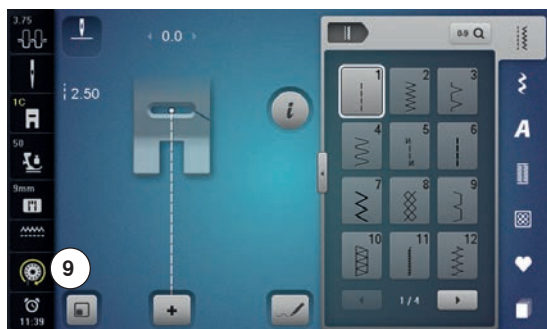

Continuing the winding process

- touch the «bobbin»-icon 9
- ▶ the winding Display opens
- touch «Start» to start winding process
- ▶ the winding process is continued



It is possible to wind the bobbin while embroidering. We recommend, however, to reduce the winding speed.

Removing the Bobbin

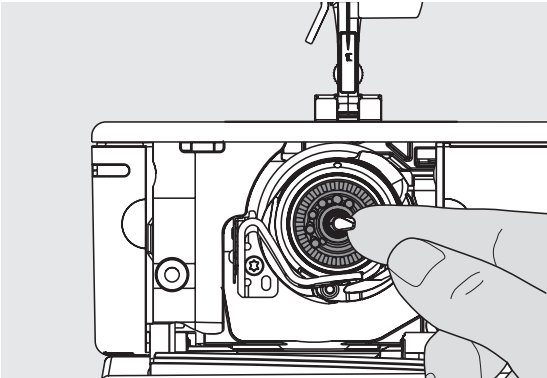

ATTENTION!

Only remove the bobbin if the hook is at the end position (threading position).

Removing the Bobbin

- open bobbin cover
- ▶ the hook system swings to the front
- push the latch in the center of the bobbin to the left
- the bobbin pops out and can be removed

Inserting the Bobbin

- with bobbin markings facing the front, place the bobbin into the hook and push until it clicks into place

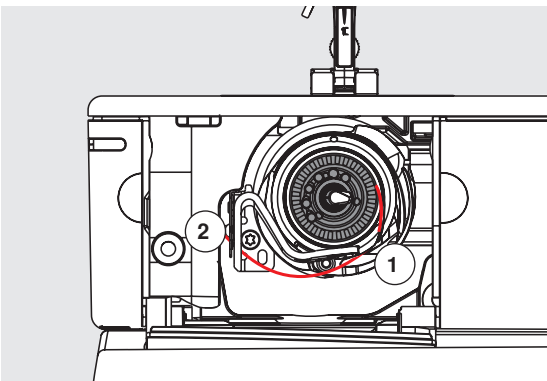

Threading lower thread

- pull the thread to the right into slit 1 then left under the spring

Thread cutter lower thread

- pull thread over thread cutter 2 and cut



Check the threading path

- after threading the hook, hold the mirror under the swung-out hook unit as shown in the pictures below
- ▶ position of bobbin thread when threaded for sewing
- close the bobbin cover slowly
- ▶ the hook swings back to the rear

Threading the Upper Thread

ATTENTION!

Do not start the threaded sewing-/embroidery computer if there is no fabric on the stitch plate.

The sewing-/embroidery computer must be switched ON for threading.

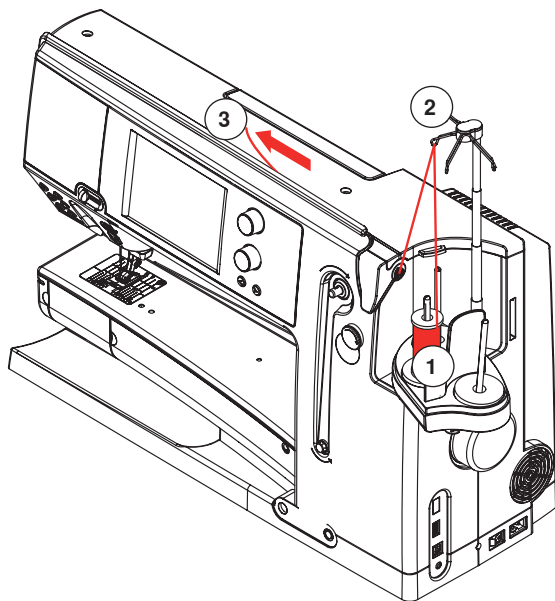

Automatic

- place thread spool on the rear or center spool pin 1
- thread the corresponding guide 2 on the telescopic rod
- hold with both hands and guide into the threading opening 3 of the sewing computer until ...

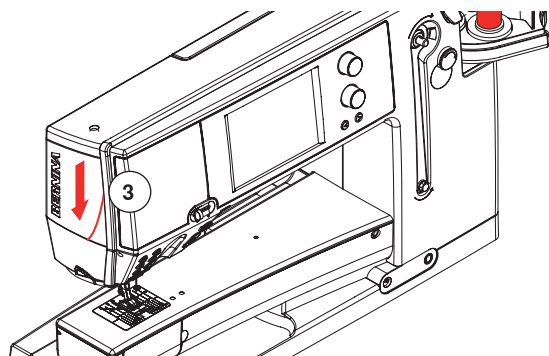

- ... taking it up to the thread guide in the needle clamp 4
- then lead it to the left into the thread clamp 5 and pull it over the thread cutter 6 from the back to the front
- touch the «Automatic threader»-button
- ▶ this will be indicated by a message and shown in an animation
- ▶ during threading the «Start/Stop»-button is illuminated red
- ▶ if the thread has been threaded correctly the «Start/Stop»-button is illuminated green

Manual

- follow the five first steps as described above
- touch the «Manual threading»-icon in the Display
- touch the «Automatic threading»-button, then thread the needle by hand



- when using unruly threads, slip the net over the upper thread spool
- large net for large spools, small net for small spools
- this prevents the upper thread from slipping and gives an even thread feed
- place the thread(s) under the presser foot and to the back before starting to sew

Changing the needle

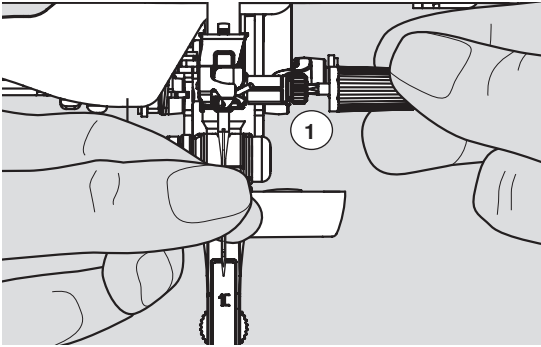

Removing the needle

- raise the needle
- remove or lower presser foot (see page 27, 39)
- turn power switch to «0» (off)
- loosen the needle clamp screw **1** using the gray screwdriver
- pull the needle down to remove

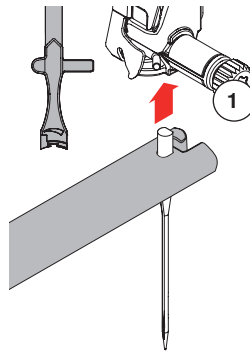

Inserting the needle

- flat side of needle to the back
- insert the needle with the multifunction tool as far as it will go
- tighten needle clamp **1** using the gray screwdriver

Threading Double/Triple Needle

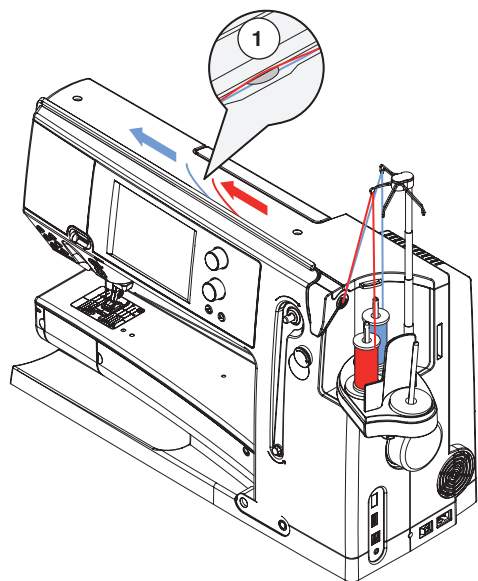

Threading Double Needle

- touch the «Security Program»-icon
- touch the corresponding needle icon in the «Security Program»-Display
- close the «Security Program»-Display
- place a thread spool on the center spool pin and one on the rear spool pin and thread the corresponding guides on the telescopic rod
- insert the two threads together into the threading slit, guiding the thread of the rear spool pin behind the thread-tension disc 1 while guiding the thread of the center spool pin in front of the tension disc 1. Then guide the two threads through the thread guide at the needle clamp
- touch the «Manual Threading»-icon in the threading animation Display. Next touch the illuminated automatic threading button
- using the manual threader in your accessory kit, manually thread the left needle and then the right needle

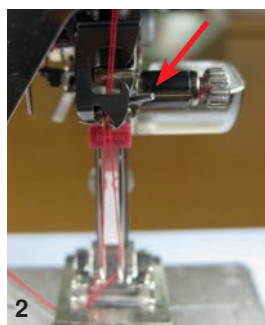

Working with the Double needle

To achieve the best sewing quality:

Upper threads must be guided separately into the thread guide of the needle clamp.

- at that point, thread the first thread behind the wire as usual (red arrow), thread the second thread in front of the wire (picture 2)
- the recommended optimal speed for Double Needles ranges from about 350-500 stitches per minute. Set the slide speed control as shown below (picture 3)
- make sure that the threads are not twisted after the thread take-up lever. For a better sight the cover can be removed

As a general guideline:

- replace the needle before starting a new sewing project
- Needles are wearing parts and by frequent use they change their features. Even after 1.5 hours of useage first abrasions are recognizable. After about 8 hours, increases in thread breakage, loops and poor stitch formation may occur.

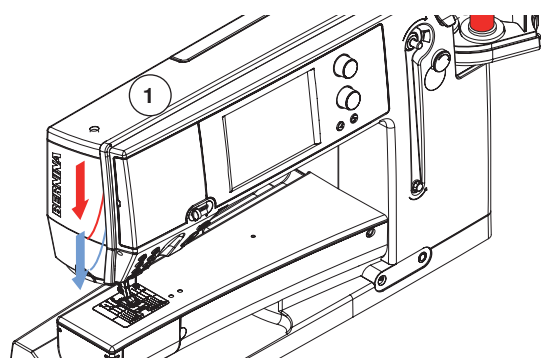

Triple Needle

- touch the «Security Program»-icon
- touch the icon of the triple needle in the «Security Program»-Display
- place a thread spool on each spool pin and thread the respective guides on the telescopic rod
- thread as usual, guiding the thread from the rear and center spool pin in the threading slit to the rear of thread tension disc 1 and the thread from the front spool pin in front of the tension disc

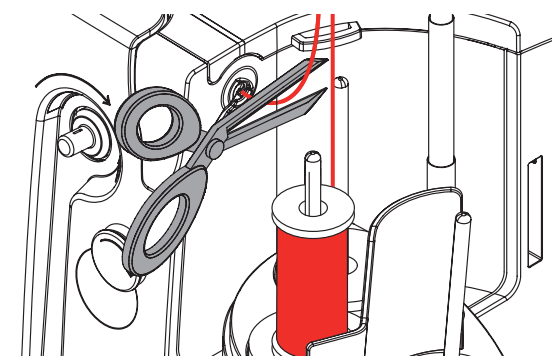

Changing the thread

- cut the spool thread before the pre-tension and pull out of the sewing computer **in front of** near the needle

Changing the presser foot

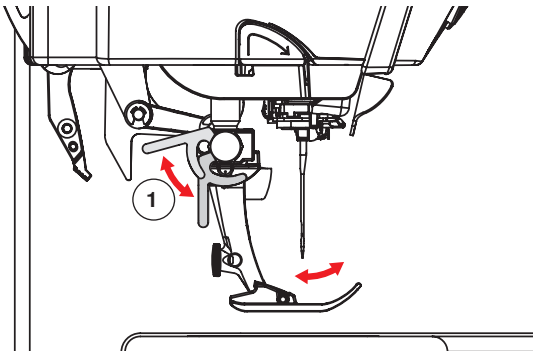

Removing the presser foot

- raise the needle and presser foot
- turn power switch to «0» (off)
- raise the clamping lever 1
- remove the presser foot

Attaching the presser foot

- guide the presser foot upwards over the cone
- press the clamping lever 1 down

Stitch plate

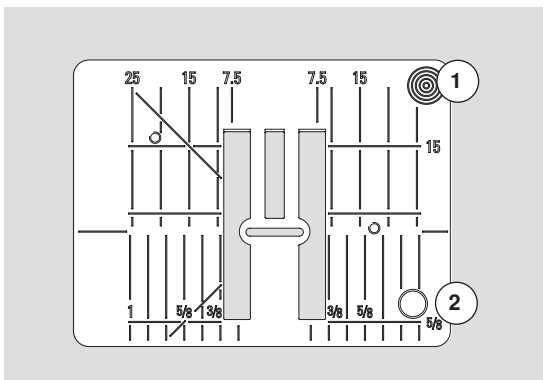

9 mm

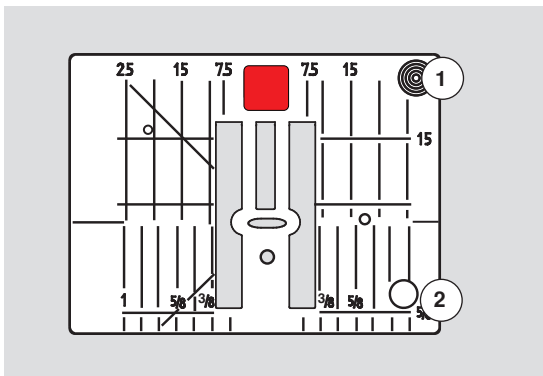

5.5 mm (optional accessory)

Marks on the stitch plate

- the stitch plate is marked with vertical, horizontal and diagonal lines in **mm** and **inches**
- the lines help to guide the fabric for sewing seams and precise topstitching, etc.
- the horizontal markings are helpful for sewing corners and buttonholes, etc.
- the diagonal markings are useful for quilting
- needle insertion point is position «0» (center needle position)
- the vertical measurements correspond to the distance between the needle and the line
- measurements are marked to the right and to the left of center needle position

Removing the Stitch Plate

- raise the presser foot and needle
- turn power switch to «0» (off)
- press the stitch plate down at the right back corner 1 until it flips up
- ▶ remove stitch plate

Replacing the Stitch Plate

- place the stitch plate over the opening 2 and press down until it clicks into place



Exchanging the Stitch Plate

Whenever the stitch plate is exchanged, it is imperative to adjust the settings in Security Program accordingly, see page 32.

Thread-Guide-and-Lubricating Unit

ATTENTION!

The silicone fluid must **ONLY** be used for thread lubrication. Never use it to lubricate the hook system!

As a thread-guide eyelet (Fig. 1)

Use the unit without lubricator for a controlled guiding of the thread into the pretensioner, e.g. when using lively thread types.

As a thread lubricator (Fig. 2)

Using the lubricator is advisable when using e.g. threads with high function values, metallic threads, loosely twisted thread types etc. The silicone fluid improves the threads' gliding properties considerably and therefore helps to produce flawless stitching results.

Assembly

- insert the unit into the spool-holder cover fixture and push down entirely (Fig. 1)
- insert the lubricator into the holder on the left side of the unit, taking care to place the lubricator in such way that the openings for the thread are in line with the thread flow or thread direction (Fig. 2)
- moisten the felt, add a few drops of silicone fluid
- place the thread spool onto the middle or rear spool pin as usual. Then guide the thread through the respective eyelet of the telescopic rod and the eyelet of the thread-guide-and-lubricating unit
- hold the thread with both hands, pull it in to the slit of the felt, pulling it down as far as it goes so that it'll stay in the felt during machine operation (Fig. 3)
- continue and complete threading the sewing computer as normal
- take care that the felt remains moistened. It mustn't dry out. Apply some drops of silicone fluid once in a while to keep it moist

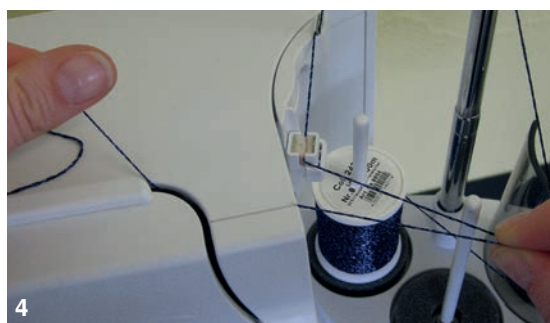
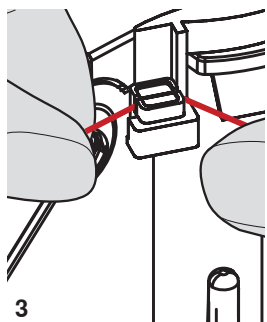
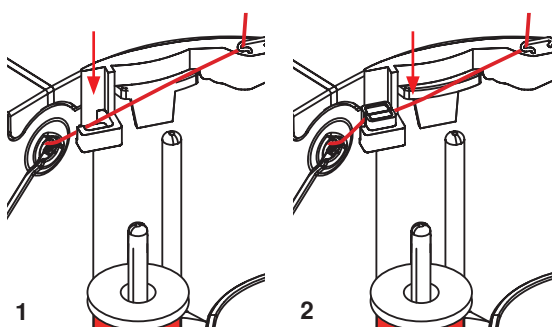

During the initial threading of the sewing computer and when the radial thread release is used it is advisable to pull an extra inch of thread from the spool before the threader button is pushed (Fig. 4).

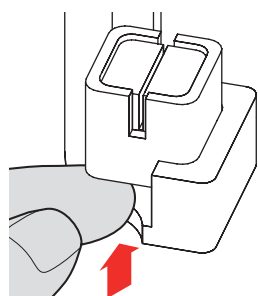

When using the Thread-Guide-and-Lubrication Unit and depending on the type of thread used it might be necessary to reduce the upper-thread tension slightly to achieve perfect stitching results.

- to remove the Thread-Guide-and-Lubrication Unit, push the entire unit up
- Reattach the Thread-Guide-and-Lubrication Unit. Thread the sewing computer as usual, including the eyelet of the unit (Fig. 2).

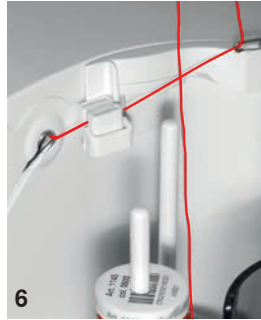
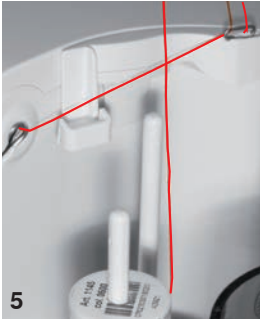

ATTENTION!

It is absolutely essential to use the correct foam disc under the thread spool.

Various Options of Application

- **Vertical thread** unwinding (with or without lubricator) from normal spool pin or optional multiple spool holder (Fig. 5-7)
- **Radial thread** unwinding (with or without lubricator) (Fig. 8)
- during the initial threading of the sewing computer and when the radial thread release is used it is advisable to pull an extra inch of thread from the spool before the threader button is pushed (Fig. 9)



Radial Thread Guide

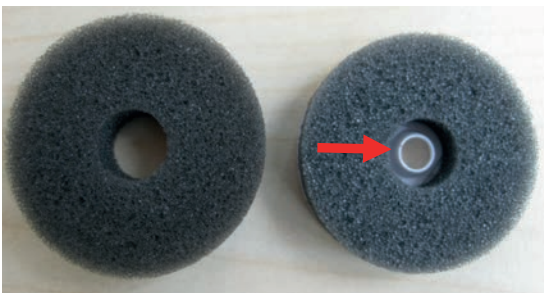

How to use the thread guide:

It is preferable to replace the standard foam disc with the foam rotary disc (with white plastic inner part) on the rear spool pin.

Application

The extra thread guide ensures the consistent thread release, when using threads i.e. metallic, lively or evenly wound thread spools.

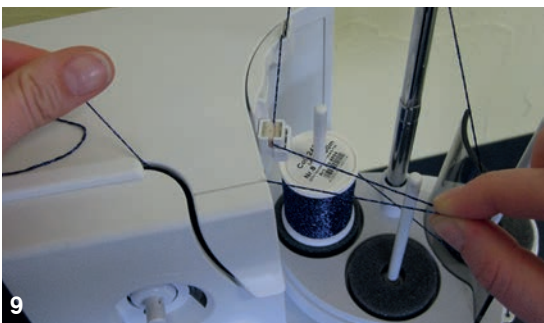

- place thread spool on spool pin and guide thread through thread guide. Then run thread via middle eyelet of telescopic rod. Continue threading the sewing computer as normal
- during the initial threading of the sewing computer and when the radial thread release is used it is advisable to pull an extra inch of thread from the spool before the threader button is pushed

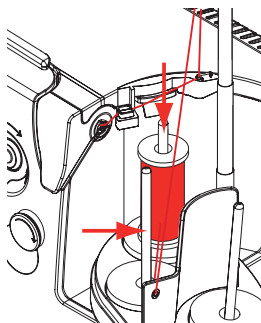

Any of the two spool pins (see arrow markings) can be used. However, it is best to use the rear pin due to its more favorable unwinding angle. Refrain from using the pin of the winder.

In order to achieve perfect stitching results, it might be necessary to reduce the upper-thread tension slightly when using the radial thread unwinding and depending on the thread used.

Upper thread tension



Higher upper thread tension = the upper thread is tightened, which pulls the lower thread up to the top of the fabric.
Lower upper thread tension = the upper thread is loosened, which enables it to be pulled to the back of the fabric.

Basic settings are applied automatically when a stitch pattern or program is selected.

The upper thread tension is set optimally at the BERNINA factory and the sewing computer has been tested. Metrosene-/Seralon thread size 100/2 (Company Mettler, Switzerland) is used for upper and lower thread.

In case of using other types of sewing or embroidery threads, the optimal tension may vary. Therefore it may be necessary to adjust the upper thread tension according to the fabric and the desired stitch pattern.



Altering upper thread tension

- touch the «Upper thread tension»-icon
- ▶ the white bar within the scale and the number in the icon show the basic setting
- touch the «+»/«-»-icon or
- turn stitch width or stitch length knob to the left or to the right or
- move the slider in the Display using the Touchscreen pen or the finger
- ▶ upper thread tension is tightened or loosened
- ▶ the alteration of the upper thread tension is visible in the yellow-framed icon and in the «Upper thread tension»-icon
- ▶ basic setting remains visible (small white dot on the slider)
- ▶ the alteration of the upper thread tension only affects the selected stitch

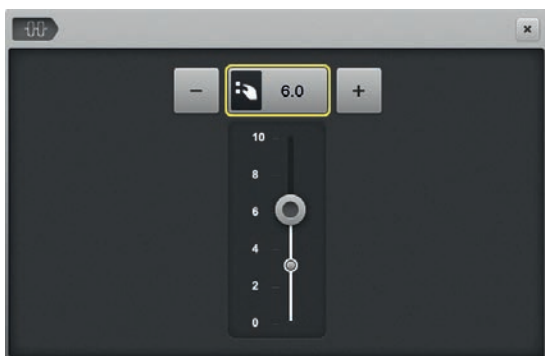

Saving the upper thread tension

- touch the «Close»- or «Upper thread tension»-icon
- ▶ the settings are saved and the Display closes

Back to basic settings

- touch the yellow-framed icon
- ▶ basic setting is reset
- switch off the sewing computer
- ▶ any alterations are deleted

Lower Thread Tension

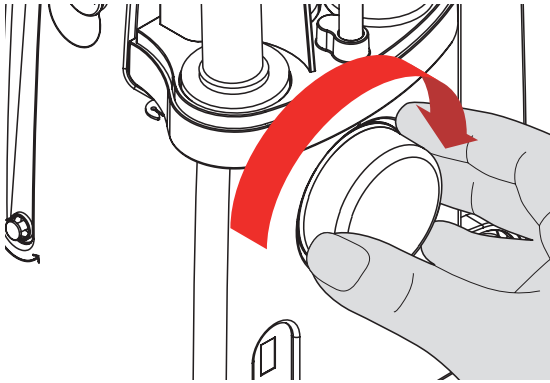

- hold bobbin case **1** firmly with your left hand
- with your right hand, turn the hand wheel clockwise until the setting tool can be slid over the lug at the slider

Basic value:

- lug of the slider matches with the marking of the bobbin carrier, or
- lug is shifted 1-2 points to the right, or
- lug is shifted 1-2 points to the left

- turn lug to the left with the setting tool
- ▶ thread tension becomes looser
- turn lug to the right with the setting tool
- ▶ thread tension becomes tighter

Change per point = 4 g.

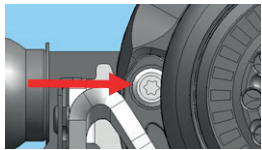
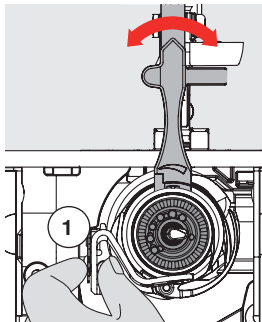

- bring hook into the position shown in the illustration by turning the handwheel clockwise in order to be able to thread it properly

Security Program



- touch the «Needle»- or «Stitch plate»-icon
- ▶ «Needle-/Stitch plate overview»-Display appears

Display

- ▶ yellow flag = recommended, optimal selection
- ▶ green flag = optimal element is selected

If an inappropriate needle/stitch plate has been selected for the selected stitch pattern, an animation will be displayed and the sewing computer cannot be started.

The function remains active even when the sewing computer is turned off and on.



Selecting the needle

- touch the desired «Needle»-icon
- ▶ stitch width is limited automatically
- ▶ this prevents the inserted special needle (double needle etc.) from hitting the presser foot or the stitch plate = no needle breakage
- ▶ numbers in the needle icons indicate the needle distance in mm
- touch the «Standard needle»-icon
- ▶ Standard needle is activated again
- ▶ the stitch width limitation is deactivated

Selecting the stitch plate

- touch desired «Stitch plate»-icon
- ▶ stitch width is limited automatically
- ▶ this prevents the inserted needle from hitting the presser foot or the stitch plate = no needle breakage



Saving

- touch the «Close»-icon or «Needle»- or «Stitch plate»-icon
- ▶ the settings are saved and the Display closes

Needle Chart



- press «Needle minder»-icon
- ▶ «Needle index»-Display appears



Selecting needle

- select attached needle and needle size

Selecting a Presser Foot

For every selected stitch pattern the optimal presser foot is displayed in «Presser foot selection»-icon.

ATTENTION!

It is **IMPORTANT** to select the attached presser foot to enable the sewing computer to recognize it and to activate the respective safety settings.

Display

- ▶ yellow flag = optional choice for selected stitch pattern
- ▶ green flag = optimal element is selected



- attach the recommended presser foot
- touch the «Presser foot selection»-icon
- ▶ the «Presser foot selection»-Display appears
- touch the icon showing the attached presser foot or attach another presser foot which is displayed in the overview and specially marked as optimal presser foot and touch the respective icon in the «Presser foot selection»-Display
- scroll through the overview via the arrow icons below the presser foot icons or touch «0-9»-icon and enter the number directly
- ▶ if the needle risks hitting the presser foot, the sewing computer cannot be started and an error message appears
- ▶ the attached presser foot is now displayed in «Presser foot selection»-icon

Optional presser feet

- touch the «Optional presser feet»-icon
- ▶ the optional presser feet for the selected stitch pattern are displayed directly

Saving

- touch the «Presser foot selection»- or the «Close»-icon
- ▶ the settings are saved and the Display closes

Return to basic settings

- touch the icon with the selected presser foot or «clr»-button
- ▶ no presser foot is selected

Altering presser foot pressure



- touch the «Presser foot pressure»-icon
 - ▶ presser foot pressure scale is displayed
 - turn stitch width or stitch length knob to the left or to the right or
 - touch the «->»- or «+>»-icon
 - ▶ presser foot pressure is increased or decreased
 - ▶ alteration of the presser foot pressure is displayed in the scale and in the yellow-framed icon
 - ▶ basic setting remains visible (small white dot on the slider)



When sewing thick material, e.g. quilting

- turn stitch width or stitch length knob to the left or
- touch the «->»-icon
 - ▶ the presser foot pressure decreases to minus
 - ▶ the presser foot is slightly raised and the material can be moved more easily



Saving presser foot pressure

- touch the «Close»-icon or «Presser foot pressure»-icon
 - ▶ the settings are saved and the Display closes

Resetting the basic setting

- touch the yellow-framed icon
 - ▶ basic setting is reset



Reset the presser foot pressure to basic setting after finishing the task.

Feed dog position



Feed dog position down

- touch the «Feed dog»-icon
 - ▶ the feed dog is lowered

Feed dog position up

- touch the yellow framed «Feed dog»-icon
 - ▶ the feed dog is raised at the next stitch

Bobbin filling



Amount of remaining thread

The remaining thread on the bobbin is displayed in a colored bar as well as in percentage.

Alarm

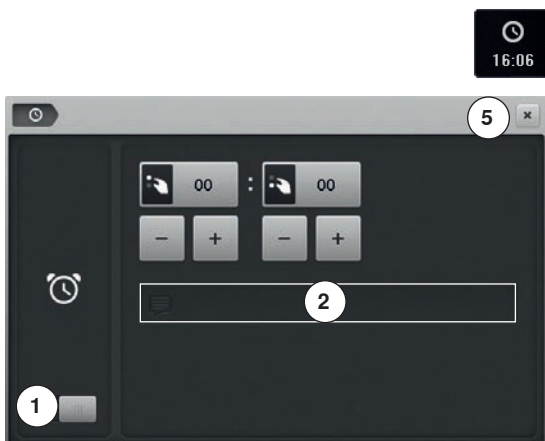

- touch the «Clock»-icon

Setting the time of the alarm

By touching the icon 1 the input fields are activated or deactivated.

- touch icon 1
- turn stitch width or stitch length knob or
- touch the «+»- or «-»-icon
- ▶ the time of the alarm (hh:mm) is set



- touch the text box 2

Individual alarm message

- create or edit the individual alarm message
- ▶ the alarm message appears in the text box 3 above the keyboard
- confirm by touching ✓
- touch the «Clock»- or «Close»-icon 5
- ▶ the Display closes
- ▶ the changed clock symbol indicates that an entry has been made

Deleting an alarm message

- touch the text box 3
- ▶ the entered text is deleted completely

Corrections

- touch icon 4
- ▶ the entered text is deleted from the right to the left

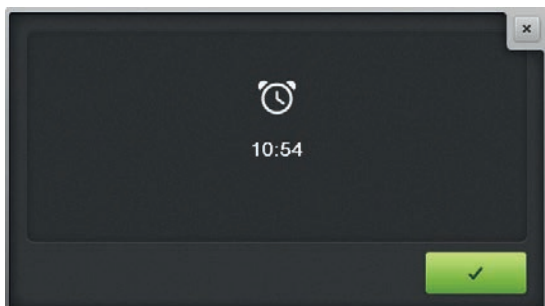

Alarm Display

When the entered time is due, the alarm Display appears.

- confirm by touching ✓
- ▶ the alarm Display closes

Feed dog and Fabric feed

With each stitch the feed dog moves forward by one step. The length of this step is determined by the stitch length selected.

With a very short stitch length the steps are very short. The fabric moves relatively slowly under the presser foot, even at full sewing speed, e.g. buttonholes and satin stitch and decorative stitches are sewn with a very short stitch length.

Let the fabric feed evenly.

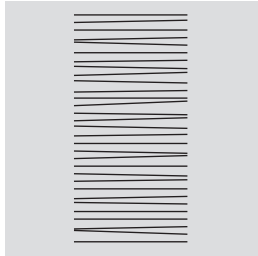
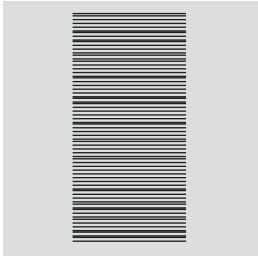
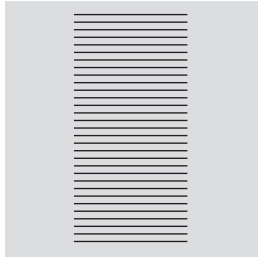

ATTENTION!

Pulling, pushing or holding back the fabric can result in damages of the needle and stitch plate.

Pulling, pushing or holding back the fabric will result in uneven stitches.

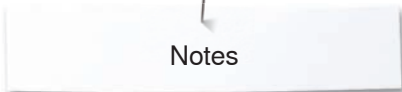

Notes

Notes

A series of horizontal lines for writing notes.

37

Functions

Overview «Function»-buttons



«Start/Stop»-button

- starts and stops the sewing computer when operating **with** or **without** foot control
- starts and stops the BSR-Function if the BSR foot is attached and activated
- raise the presser foot slightly quick press while sewing to pivot or move the sewing work



«Quick reverse»/«Permanent reverse sewing»-button

- secures the seam beginning and end: sews in reverse as long as the button is pressed
- used to program the buttonhole length
- used to program the darning length
- used to determine end of stitching in straight stitch Securing Stitch No. 5
- used for securing in Quilters securing program No. 1324

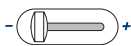

Slide speed control

- the sewing and embroidering speed is infinitely variable with the slide

ATTENTION!

The «Automatic threader»-button mustn't be activated with one of these presser feet attached nos. 48, 50, 55, 85, 86, 93 and the cut'n'sew No. 80.



«Automatic threader»-button

- touch button = finishes the threading process and threads the needle



Double, triple and wing needles require manual threading after the button has been pressed. Use the «Automatic needle threader»-button for needle sizes 70-120. Metallic threads, thick threads like cordonnet and difficult to work with threads should be threaded by hand.



Programmable «Pattern end-/Securing»-button

- press button before or during sewing
- ▶ single pattern is secured at the end, with the selected number of stitches programmed
- press button before or during sewing of a combination
- ▶ the active pattern of the combination is secured at the end, with the selected number of stitches programmed
- the number and type of the securing stitches can be programmed in the Setup-Program
- ▶ a stop symbol which appears during sewing indicates that the function is activated



«Needle stop»-button

- press the button
- ▶ the needle is raised or lowered in the same way as by sinking the heel back on the foot control



«Automatic Securing Program»-button

- press the button before sewing start = the individual pattern/combination is secured at the beginning with the number of programmed stitches
- keep the button pressed while sewing = the sewing computer stops at once and sews the number of programmed stitches
- the number and type of the securing stitches can be programmed in the Setup-Program



«Presser foot position»-button

- press the button
- ▶ the presser foot is lowered and raised a bit again for easy positioning of the material
- ▶ the presser foot is lowered on the fabric when start sewing
- press the button again
- ▶ the foot is raised and the feed dog is lowered simultaneously



«Automatic thread cutter»-button

- the upper and the lower threads are cut automatically
- 2-6 securing stitches can be programmed in the Setup-Program. These are sewn before the thread is cut



Stitch width and Stitch length Knobs (Multifunction)

- to adjust stitch width or stitch length
- to alter thread tension
- to set the buttonhole slit width or the button size
- to adjust the balance
- various alterations in the Setup-Program
- various alterations when embroidering



«Needle position»-buttons

- press the left button
- ▶ needle moves to the left
- press the right button
- ▶ needle moves to the right
- keep button pressed
- ▶ quick change
- total of 11 needle positions (5 left, 5 right, 1 center = 0)



Needle stop position up and «Quick reverse»-button

If «Quick reverse»-button is pressed while sewing or after stopping (e.g. zig-zag) with programmed needle stop **up**, the sewing computer sews one stitch forward before it switches to sewing in reverse.



Needle stop position down and «Quick reverse»-button

If «Quick reverse»-button is pressed after stopping (e.g. zig-zag) with programmed needle stop **down**, the sewing computer switches to sewing in reverse immediately.

Display

Overview Main Display

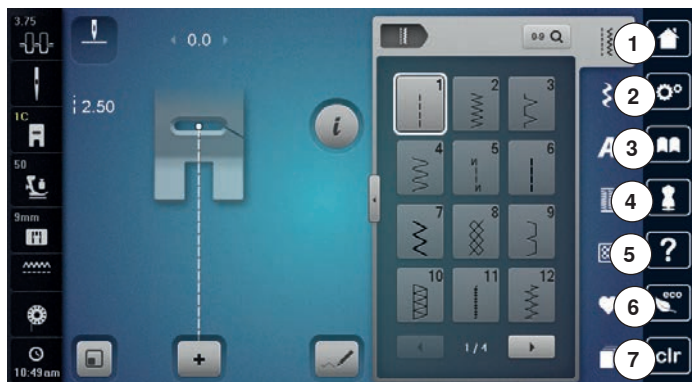

System settings

- 1 Home
- 2 Setup-Program
- 3 Tutorial
- 4 Creative Consultant/Embroidery Consultant
- 5 Help
- 6 ECO
- 7 Clear settings



External Functions/Views

- 8 Upper thread tension
- 9 Security needle
- 10 Presser foot indicator/Presser foot selection
- 11 Presser foot pressure
- 12 Security stitch plate
- 13 Feed dog recognition
- 14 Filling bobbin/Winding the lower thread
- 15 Time/Alarm

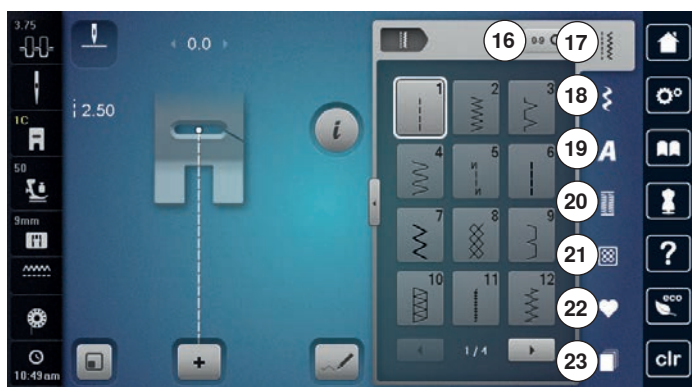

Menu Selection

- 16 Stitch selection by number
- 17 Practical stitches
- 18 Decorative stitches
- 19 Alphabets
- 20 Buttonholes
- 21 Quilt stitches
- 22 Personal program/Memory
- 23 History

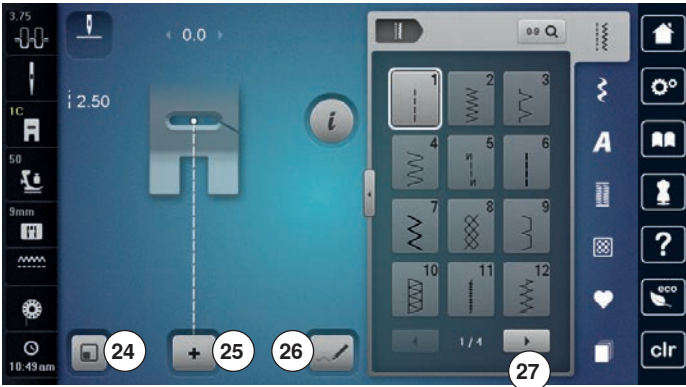

Selection

- 24 Fit to screen
- 25 Single and combi mode
- 26 Stitch Designer
- 27 Scroll right/left



Stitch Pattern Area

- 28 Stitch pattern selection

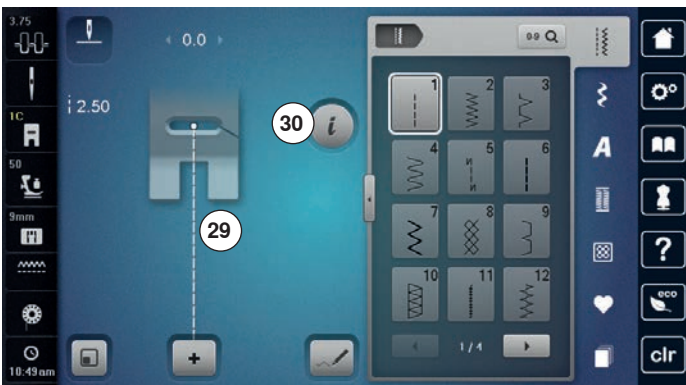

Stitch Pattern Display

- 29 Display of the stitch pattern selected
- 30 Information

Functions - Display

Sewing Functions Overview



- touch the «i»-icon
- ▶ «Function»-Display appears

Functions

- 1 Needle stop down/up (permanent)
- 2 Pattern begin
- 3 Pattern repeat
- 4 Mirror Image left/right
- 5 Mirror Image down/up
- 6 Balance
- 7 Altering pattern length/Stitch density
- 8 Stitch Counter
- 9 Long stitch
- 10 Multi-Directional sewing
- 11 Distorting stitch patterns
- 12 Balance BERNINA Dual Transport
- 13 Permanent reverse sewing
- 14 Backstepping
- 15 Personal memory permanent
- 16 Reset

Scrolling Functions

When not all functions are shown directly, please proceed as follows:

- touch the «Function»-Display using the finger or the Touchscreen pen, keep it pressed and move it up
- ▶ additional functions appear

General Functions



Information

- touch the icon
- ▶ another Display is opened



Close

- touch the icon
- ▶ the previous Display appears
- ▶ any alterations are accepted



Confirm selection

- touch the icon
- ▶ alteration/selection is activated or confirmed



Escape Display

- touch the icon
- ▶ the Display is closed
- ▶ the previous Display appears



Needle stop down/up (permanent)

- touch the icon
- ▶ the needle symbol jumps down
- ▶ the sewing computer stops with needle down
- touch the icon again
- ▶ the needle symbol jumps up
- ▶ the sewing computer stops with needle up



Pattern begin

- ▶ the function appears, when the sewing computer is stopped while sewing a single pattern or a pattern combination
- touch the icon
- ▶ the selected stitch pattern or program is set to pattern begin



Pattern repeat

- touch icon 1x
- ▶ number 1 appears: the sewing computer stops at the end of an individual stitch or a stitch combination
- touch icon 2-9x
- ▶ numbers 2-9 appear: the sewing computer stops at the end of an individual stitch pattern or a stitch combination after the number of repeats selected



Mirror Image left/right

The sewing computer sews the stitch pattern mirrored, left/right referring to the sewing direction.



Mirror Image up/down

The sewing computer sews the stitch pattern mirrored up/down referring to the sewing direction.



Balance

To balance forward and reverse stitches.

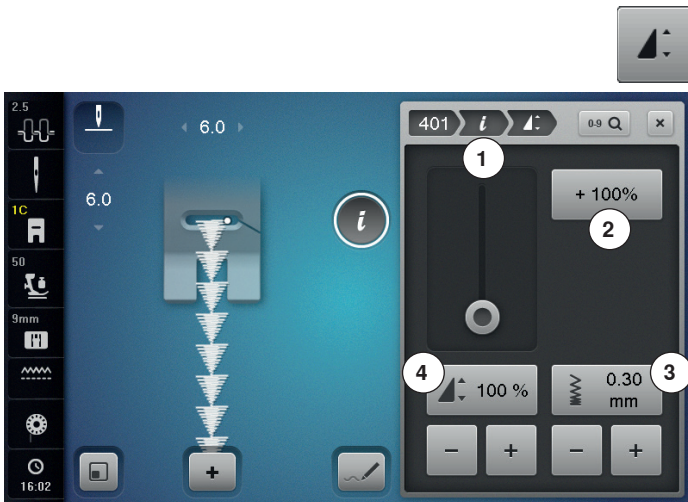

Altering stitch density 3

Certain decorative stitches (e.g. No. 401) allow an alteration of the stitch density. The set stitch pattern length will not be affected.

- touch the «+»-icon
 - ▶ the stitch density is reduced in 0.05 mm-steps
 - ▶ the stitch distance is increased
- touch the «-»-icon
 - ▶ the stitch density is increased in 0.05 mm-steps
 - ▶ the stitch distance is decreased
- ▶ touch the «Back»-icon 1
- ▶ the Function Overview appears again



Altering the pattern length 4

- move slider in the Display using the Touchscreen pen or the finger
 - ▶ pattern length (Standard = 100%) is infinitely variable
 - extend or shorten in 1%-steps using «+»/«-» or
 - touch the «+100%»-icon 2
 - ▶ pattern length is extended in 100%-steps
- Maximum length is 1000%, shortest length 10%. Some stitch patterns are limited and cannot be extended to 1000%.



Stitch Counter

- when the desired length is obtained, press the «Quick reverse»-button
 - ▶ the Display changes to «auto»
 - ▶ the selected stitch pattern is temporarily programmed



Long stitch

- the sewing computer sews every **second** stitch (max. stitch length 12 mm)
 - applicable for practical and decorative stitches
- Exception:** buttonholes, alphabets



Multi-Directional sewing

- use the stitch width knob to rotate the stitch pattern or combination in 0.5°-steps, the stitch length knob for 1°-steps or the «Direct-selection»-buttons for 45°-steps into the desired direction
 - ▶ the sewing direction is shown in the left part of the Display
 - ▶ the start is marked with a white dot and the end with a red cross
 - ▶ the function only appears if the selected stitch can be sewn in multiple directions



Distorting stitch patterns

- touch the icon
- touch the upper «+» or «-» icon or turn the stitch width knob to the right or to the left
- ▶ the stitch pattern will be distorted in 0.01 mm steps to the right or to the left

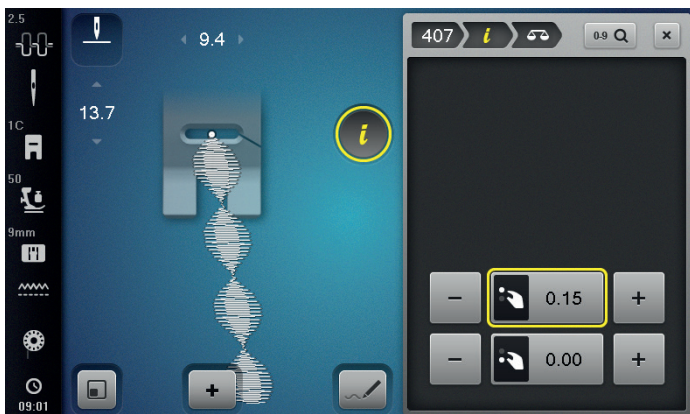

- touch the lower «+» or «-» icon or turn the stitch length knob to the right or to the left
- ▶ the stitch pattern will be distorted in 0.01 mm steps forwards or backwards

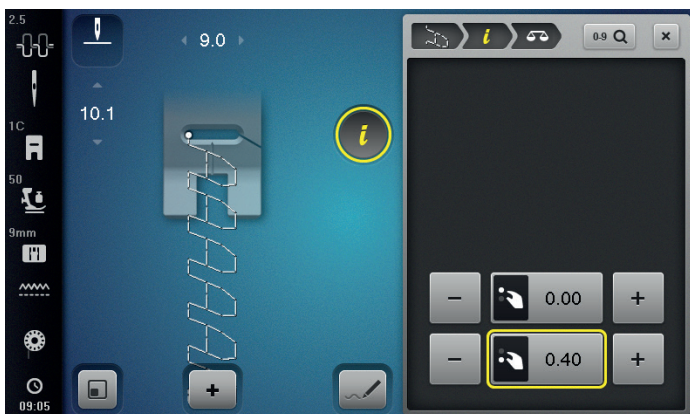

Balance BERNINA Dual Transport
Adjusting the feed of the upper fabric layer.



Permanent reverse sewing
The sewing computer sews the selected stitch pattern in reverse.



Backstepping
The last 200 needle penetrations of a stitch pattern are retraced, i.e. sewn backwards.



Personal memory permanent

- select a stitch pattern and alter e.g. stitch length or stitch width
- touch the icon
- ▶ the altered stitch pattern is saved



Reset

- touch the icon
- ▶ any alterations of the selected stitch pattern are reset to basic setting

Overview Functions Buttonholes



- press the «Buttonhole»-button
- select the buttonhole
- touch the «i»-icon

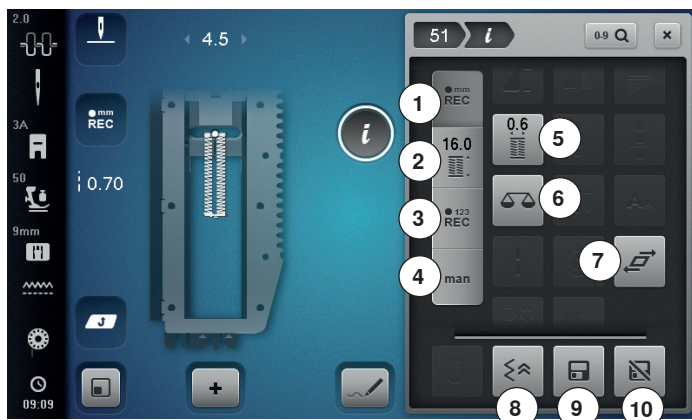

Altering the buttonhole

- 1 Programming the buttonhole length
- 2 Buttonhole length direct entry
- 3 Stitch counter buttonhole
- 4 Manual buttonhole
- 5 Buttonhole slit width
- 6 Balance
- 7 Distorting stitch patterns
- 8 Backstepping
- 9 Personal memory permanent
- 10 Reset



Programming buttonhole length

- ▶ the icon is active automatically after a buttonhole has been selected
- determine the buttonhole length by pressing the «Quick reverse»-button or
- program the indicated length directly in the icon below by touching the icon



- ▶ function turns inactive after programming the length
- if a new length is to be programmed, touch the icon again



Buttonhole length direct entry

Determine the buttonhole length via the stitch width or stitch length knob. Length in mm.



Stitch counter buttonhole

- Having sewn the desired length of the 1st bead, then
- press «Quick reverse»-button

Having sewn the desired length of the 2nd bead, then

 - press «Quick reverse»-button
 - ▶ Display shows «auto»
 - ▶ the buttonhole is programmed



Manual buttonhole

- sew a manual buttonhole in 5 or 7 steps (depending on buttonhole type)
- select every step via the arrow icons «up»/«down» or via the direct selection



Buttonhole slit width

- set the buttonhole slit width to between 0.1 mm and 2.0 mm using the stitch width or the stitch length knob



Balance

To balance forward and reverse stitches.



Backstepping

The last 200 needle penetrations of a stitch pattern are retraced, i.e. sewn backwards.



Personal memory permanent

- select a stitch pattern and alter e.g. stitch length or stitch width
- touch the icon
- ▶ the altered stitch pattern is saved



Reset

- touch the icon
- ▶ any alterations of the selected stitch pattern are reset to the original basic setting

Overview Functions Alphabets



- touch the «Alphabet»-button
- select Alphabet
- touch the «i»-icon

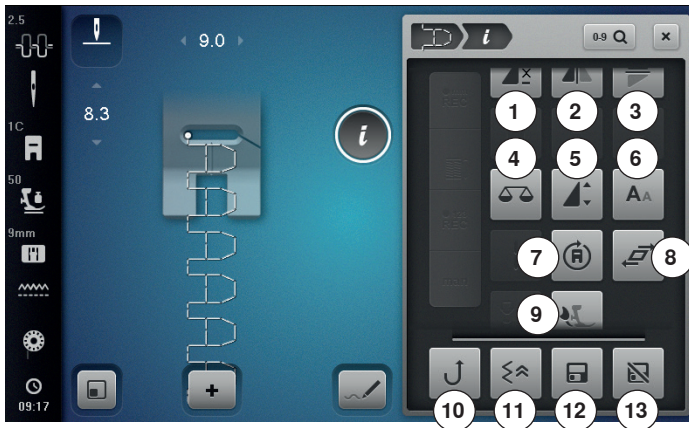

Altering Alphabet

- 1 Pattern repeat
- 2 Mirror Image left/right
- 3 Mirror Image up/down
- 4 Balance
- 5 Altering the pattern length
- 6 Font size in alphabets
- 7 Multi-Directional sewing
- 8 Distorting stitch patterns
- 9 Balance BERNINA Dual Transport
- 10 Permanent reverse sewing
- 11 Backstepping
- 12 Personal memory permanent
- 13 Reset



Pattern repeat

- touch icon 1x
- ▶ number 1 appears: the sewing computer stops at the end of an individual stitch pattern or a stitch pattern combination
- touch icon 2-9x
- ▶ numbers 2-9 appear: the sewing computer stops at the end of an individual stitch pattern or a stitch pattern combination after the number of repeats selected



Mirror Image left/right

The sewing computer sews the stitch pattern mirrored, left/right referring to the sewing direction.



Mirror Image up/down

The sewing computer sews the stitch pattern mirrored up/down referring to the sewing direction.



Balance

To balance forward and reverse stitches.



Altering the pattern length

- move the slider in the Display using the Touchscreen pen or the finger
- ▶ pattern length (Standard = 100%) is infinitely variable
- extend or shorten in 1%-steps using the «+»/«-»-icons or
- touch the «+100%»-icon
- ▶ the pattern length is extended in 100%-steps
Maximum length is 200%, shortest length is 10%.



Font size in alphabets

- select alphabet
- ▶ font size is 9 mm
- touch the icon
- ▶ the small «A» is activated
- ▶ the font size is reduced



Multi-Directional sewing

- use the stitch width knob to rotate the stitch pattern or combination in 0.5°-steps, the stitch length knob for 1°-steps or the «Direct-selection»-buttons for rotating in 45°-steps into the desired direction
- ▶ the sewing direction is shown in the left part of the Display
- ▶ the start is marked with a white dot and the end with a red cross
- ▶ the function only appears if the selected stitch can be sewn in multiple directions



Balance BERNINA Dual Transport

Adjusting the feed of the upper fabric layer.



Permanent reverse sewing

The sewing computer sews the selected stitch pattern in reverse.



Backstepping

The last 200 needle penetrations of a stitch pattern are retraced, i.e. sewn backwards.



Personal memory permanent

- select a stitch pattern and alter e.g. stitch length or stitch width
- touch the icon
- ▶ the altered stitch pattern is saved



Reset

- touch the icon
- ▶ any alterations of the selected stitch pattern are reset to basic setting

Overview Functions Combi mode



- touch the «Combi mode»-icon
- select stitch pattern
- touch the «i»-icon



Combination mode

- 1 Mirror Image left/right
- 2 Mirror Image up/down
- 3 Deleting
- 4 Editing the whole combination
- 5 Editing a combination at cursor position
- 6 Balance
- 7 Altering the pattern length
- 8 Font size in alphabets
- 9 Long stitch (without alphabets)
- 10 Multi-Directional sewing
- 11 Distorting stitch patterns
- 12 Balance BERNINA Dual Transport
- 13 Permanent reverse sewing
- 14 Backstepping



Mirror Image left/right

The sewing computer sews the stitch pattern mirrored, left/right referring to the sewing direction.



Mirror Image up/down

The sewing computer sews the stitch pattern mirrored up/down referring to the sewing direction.



Deleting

Deletes an individual stitch.



Editing the whole combination

- touch the icon
- ▶ Display appears



Editing a combination at cursor position

- touch the icon
- ▶ Display appears



Balance

To balance forward and reverse stitches.



Altering the pattern length

- move the slider in the Display using the Touchscreen pen or the finger
 - ▶ pattern length (Standard = 100%) is infinitely variable
 - extend or shorten in 1%-steps using «+»/«-»-icons or
 - touch the «+100%»-icon
 - ▶ the pattern length is extended in 100%-steps
- Maximum length is 1000%, shortest length 10%. Some stitch patterns are limited and cannot be extended to 1000%.



Font size in alphabets

- select Alphabet
- ▶ font size is 9 mm
- touch icon
- ▶ small «A» is activated
- ▶ the font size is reduced



Long stitch (without alphabets)

- the sewing computer sews every **second** stitch (max. stitch length 12 mm)
- applicable for practical and decorative stitches

Exception: alphabets



Multi-Directional sewing

- use the stitch width knob to rotate the stitch pattern or combination in 0.5°-steps, the stitch length knob for 1°-steps or the «Direct-selection»-buttons for rotating in 45°-steps into the desired direction
- ▶ the sewing direction is shown in the left part of the Display
- ▶ the start is marked with a white dot the end with a red cross
- ▶ the function only appears if the selected stitch can be sewn in multiple directions



Balance BERNINA Dual Transport

Adjusting the feed of the upper fabric layer.



Permanent reverse sewing

The sewing computer sews the selected stitch pattern in reverse.



Backstepping

The last 200 needle penetrations of a stitch pattern are retraced, i.e. sewn backwards.



- touch the «Combi mode»-icon
- select the stitch pattern
- touch the «i»-icon
- touch the «Cursor position»-icon

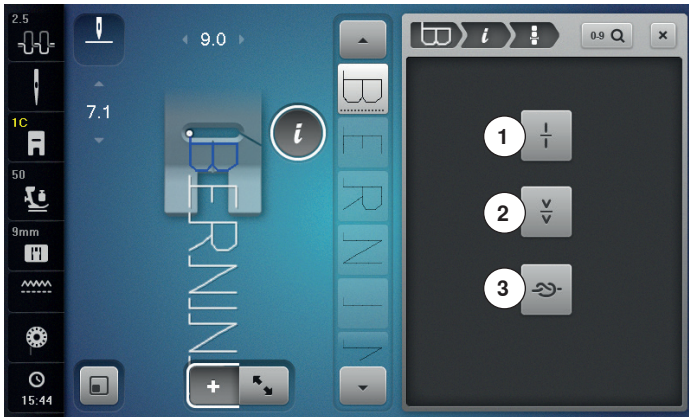

Functions

- 1 Combination subdivider
- 2 Combination subdivider
- 3 Securing



Combination subdivider

- every combination can be subdivided into several parts
- only the combination section where the cursor is located will be sewn
- to sew another section, the cursor must be placed into this part



Combination subdivider

- each combination can be interrupted as desired
- after stopping, the needle moves to the next part to be sewn



Securing

- to program the function within a pattern combination
- each individual pattern of the combination can be secured at the start or the end



- touch the «Combi mode»-icon
- select the stitch pattern
- touch the «i»-icon
- touch the «Edit whole combination»-icon

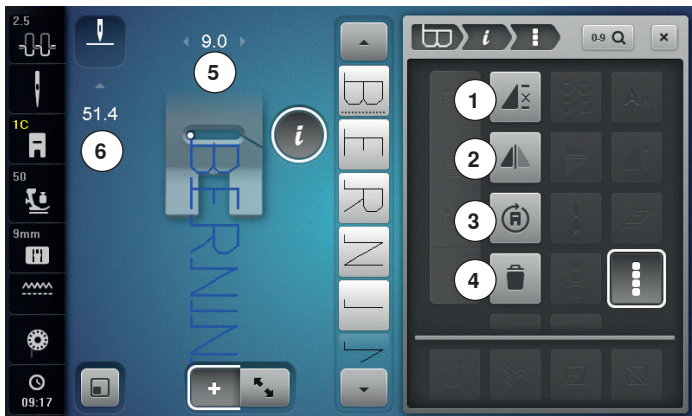

Functions

- 1 Combination repeat
- 2 Mirror Image left/right
- 3 Deleting
- 4 Editing the whole combination
- 5 Multi-Directional sewing



Combination repeat

- touch icon 1x
 - ▶ number 1 appears: the sewing computer stops at the end of a pattern combination
- touch icon 2-9x
 - ▶ numbers 2-9 appear: the sewing computer stops at the end of a stitch combination after the number of repeats selected



Mirror Image left/right

The sewing computer sews the whole combination mirrored, left/right referring to the sewing direction.



Deleting

Deletes the whole combination.



Editing the whole combination

- touch the icon
 - ▶ Display appears



Multi-Directional sewing

- use the stitch width knob to rotate the stitch pattern or combination in 0.5°-steps, the stitch length knob for 1°-steps or the «Direct-selection»-buttons for rotating in 45°-steps into the desired direction
 - ▶ the sewing direction is shown in the left part of the Display
 - ▶ the start is marked with a white dot the end with a red cross
 - ▶ the function only appears if the selected stitch can be sewn in multiple directions



Adjusting the width in the combination

- touch the «Stitch width Display»-icon 6
 - ▶ «Stitch width»-Display appears
- touch the «Adjust width in combination»-icon
 - ▶ the width of all the stitch patterns are adjusted to the widest stitch pattern within the combination



Adjusting the length in the combination

- touch the «Stitch length Display»-icon 7
 - ▶ «Stitch length»-Display appears
- touch the «Adjust Length in Combination»-icon
 - ▶ the length of all the stitch patterns are adjusted to the longest stitch pattern within the combination



- touch the «Combi mode»-icon
- creating combinations
- touch the «Editing mode»-icon
- touch the «i»-icon

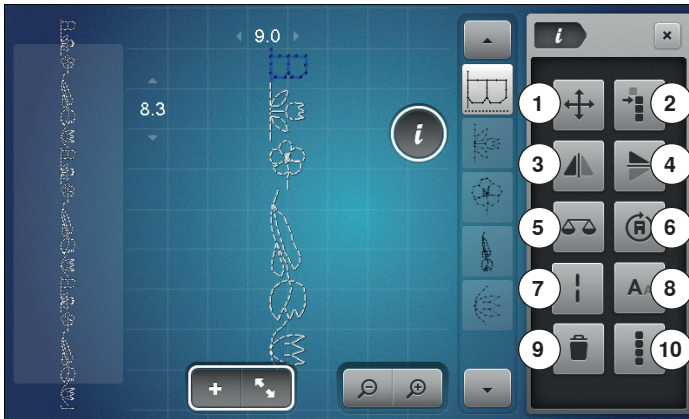

Functions

- 1 Connecting stitches/Moving single patterns in a combination
- 2 Moving multiple stitch patterns of a combination
- 3 Mirror Image left/right
- 4 Mirror Image up/down
- 5 Balance
- 6 Multi-Directional sewing
- 7 Long stitch
- 8 Font size in alphabets
- 9 Deleting
- 10 Editing the whole combination



Connecting stitches/Moving single patterns in a combination

Opens the Display to add connecting stitches.



Moving single stitch patterns in a combination

Single stitch patterns of combinations can be moved horizontally, vertically or diagonally.



Moving multiple stitch patterns of a combination

Multiple stitch patterns of combinations can be moved horizontally, vertically or diagonally.



Mirror Image left/right

The sewing computer sews the stitch pattern mirrored, left/right referring to the sewing direction.



Mirror Image up/down

The sewing computer sews the stitch pattern mirrored up/down referring to the sewing direction.



Balance

To balance forward and reverse stitches.



Multi-Directional sewing

- use the stitch width knob to rotate the stitch pattern or combination in 0.5°-steps, the stitch length knob for 1°-steps or the «Direct-selection»-buttons for rotating in 45°-steps into the desired direction
- ▶ the sewing direction is shown in the left part of the Display
- ▶ the function only appears if the selected stitch can be sewn in multiple directions



Long stitch

- the sewing computer sews every **second** stitch (max. stitch length 12 mm)
- applicable for practical and decorative stitches

Exception: alphabets



Font size in alphabets

- select alphabet
- ▶ font size is 9 mm
- touch the icon
- ▶ small «A» is activated
- ▶ the font size is reduced



Deleting

Deletes an individual stitch.



Editing the whole combination

- touch the icon
- ▶ functions are activated

Setup-Program

Overview «Setup»-Display

The Setup-Program enables an individual adjustment of the Display surface and the settings according to your personal requirements.

After setting the sewing computer to your personal requirements, all changes made in the Setup-Program are saved, even when the sewing computer is switched off.

Exceptions from this rule are outlined within the description of the function concerned in each case.



- press «Setup»-button
- ▶ «Setup-Program»-Display is opened



- 1 Sewing settings
- 2 Embroidery settings
- 3 Personal settings
- 4 Monitoring
- 5 Audio system
- 6 Sewing computer settings

Sewing settings



- touch the «Sewing setting»-icon

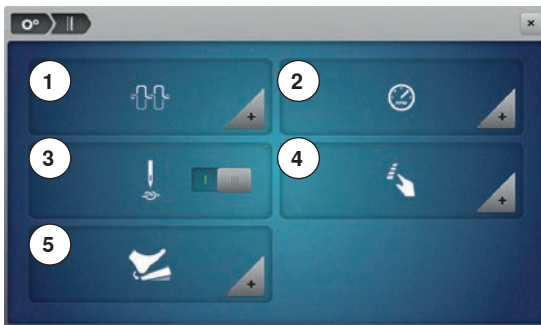

- 1 Altering Upper thread tension
- 2 Sewing speed control
- 3 Securing stitches when starting to sew
- 4 Programming «Function»-buttons/«Function»-icon
- 5 Programming the foot control



Altering Upper thread tension

- touch the «Thread tension»-icon



- move the slider in the Display to the left/right using the Touchscreen pen or the finger or
- turn the stitch width or the stitch length knob or
- touch the «+»/«-»-icon
- ▶ alters the basic setting of the upper thread tension **1** at plus or minus two basic values
- ▶ 0.0 = basic setting



Sewing speed control

- touch the «Sewing speed control»-icon



- move the slider in the Display to the left/right using the Touchscreen pen or the finger or
- turn the stitch width or the stitch length knob or
- touch the «+»/«-»-icon
- ▶ alters the maximal sewing speed **2**
- ▶ the number in the yellow-framed icon indicates the stitches per minute, the basic value is displayed by a small white dot



Securing stitches when starting to sew

The securing stitches are sewn after the thread cutter or the threader have been used.

- ▶ the function is active (standard)
- ▶ before sewing the stitch pattern, 4 securing stitches are sewn first
- touch gray icon
- ▶ function is inactive = no securing stitches will be sewn

Setup-Program



Programming «Function»-buttons/«Function»-icon

- touch the «Function»-icon



- 1 Automatic securing program
 - 2 Programming «Securing»-button
 - 3 Hover position of the presser foot
 - 4 Automatic thread cutter and securing stitches
 - 5 Programming «Quick reverse»-button
 - 6 Presser foot position with needle stop down
- select desired icon



Automatic securing program

- touch the «Securing program»-icon

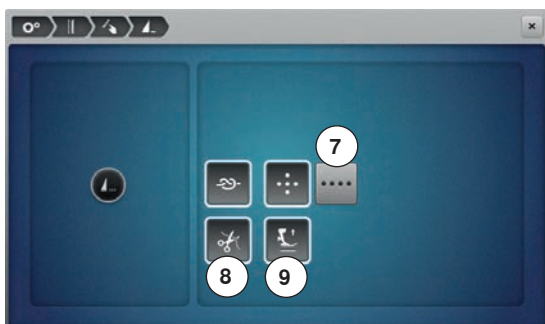

The number and type of the securing stitches of the external «Pattern end/Securing»-button can be programmed.

- ▶ standard = four securing stitches sew in place
- select function 7 to secure with small stitches sewn in a forward direction
- via «+»/«-»-icons three to six securing stitches can be programmed

Automatic thread cutter

- ▶ if function 8 is activated, the upper and lower thread are automatically cut after sewing the securing stitches

Raising the presser foot

- ▶ if function 9 is activated the presser foot is raised after securing
- ▶ if function is not activated, the presser foot remains down



Programming «Securing»-button

- touch the «Securing Button»-icon

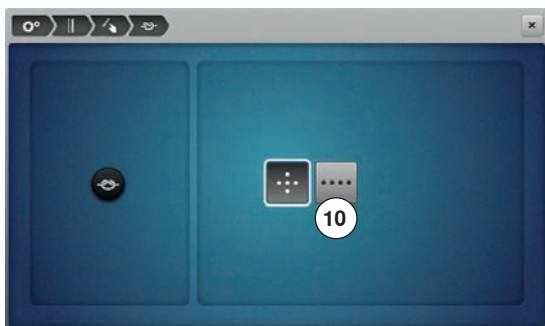

The number and type of the securing stitches can be programmed using the «Securing»-button.

- ▶ standard = four securing stitches in the same place
- select function 10 for small securing stitches sewn in a forward direction
- via «+»/«-»-icons two to six securing stitches can be programmed



Hover position of the presser foot

- touch the «Hover position»-icon



- turn the stitch width or stitch length knob or
- touch the «+»/«-»-icon
- the margin of raising can be adjusted from 0 mm to 7 mm
- ▶ Standard = 2 mm
- ▶ the set value = the distance between material and presser foot, is displayed in the icon 11

Back to basic settings

- touch the yellow-framed icon
- ▶ basic setting is restored



Automatic thread cutter and securing stitches

- touch «Thread cutter»-icon

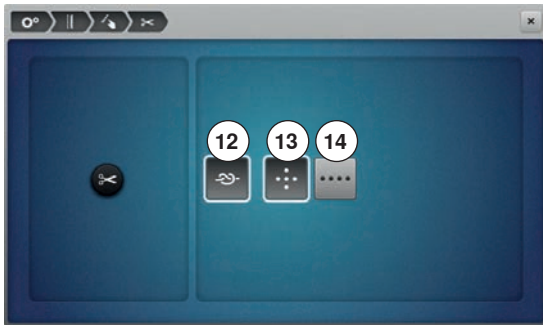

The number and type of the securing stitches before the thread is cut can be programmed.

- ▶ standard = no securing stitches programmed
- touch icon **12**
- ▶ icon **13** is activated
- ▶ four securing stitches are sewn at the place
- select icon **14** to secure with small stitches sewn in a forward direction
- via «+»/«-»-icons two to six securing stitches can be programmed



When sewing with BSR, no securing stitches are sewn.



Programming «Quick reverse»-button

- press «Quick reverse»-icon

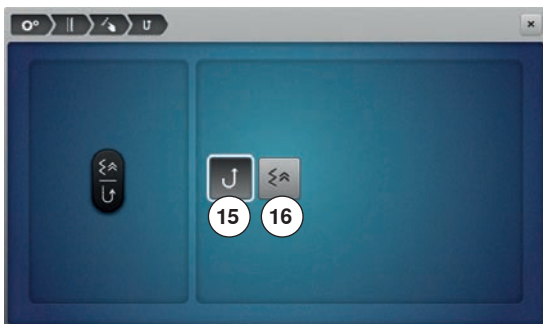

- ▶ with activated icon **15** the sewing computer sews in continuous reverse when pressing «Quick reverse»-button
- ▶ with activated icon **16** the sewing computer sews backwards stitch-by-stitch when pressing «Quick reverse»-button



Presser foot position with needle stop down

- touch the «Presser foot position»-icon

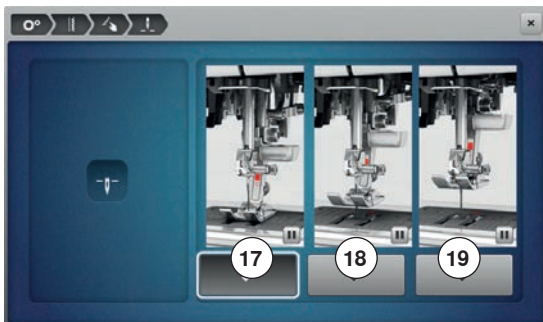

- ▶ with activated icon **17**, the presser foot remains down when the sewing computer stops
- ▶ with activated icon **18**, the presser foot is raised enough to pivot the fabric (hover position)
- ▶ with activated icon **19**, the presser foot is raised into its highest position



Programming the foot control

- touch the «Foot control»-icon

- Standard = icon 1 is activated.
- back heel kick in the foot control
 - ▶ the needle is raised or lowered

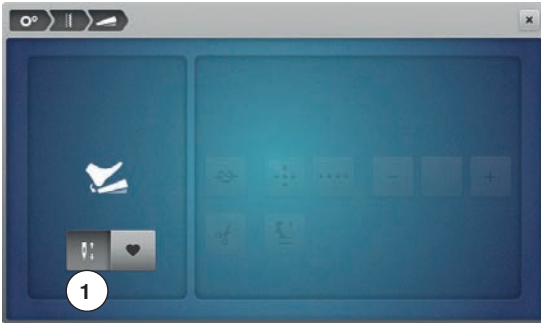

- touch icon 2

Programming securing stitches

- ▶ when the icon 3 is activated, the number and type of securing stitches can be programmed via back-heel-kick on the foot control
- ▶ Standard = four securing stitches at the place
- touch icon 4 for securing stitches forward
- using the «+»/«-»-icons two up to six securing stitches can be programmed

Automatic thread cutter

- ▶ with icon 5 activated, the upper and the lower thread are cut automatically by back heel kick
- ▶ is the icon deactivated, the threads cannot be cut

Raising the presser foot

- ▶ with the icon 6 activated, the presser foot is raised by back heel kicking
- ▶ is the icon deactivated, the presser foot remains down

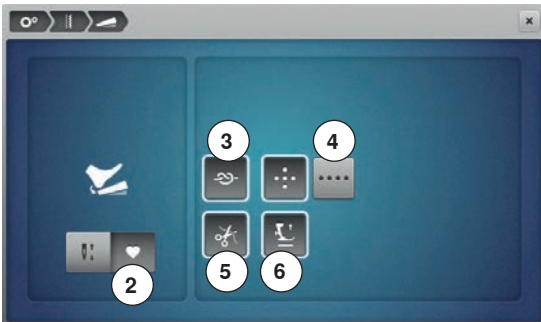

Embroidery settings



- touch the «Embroidery settings»-icon

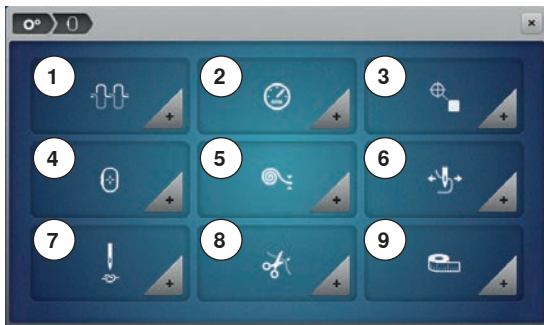

- 1 Altering Upper thread tension
- 2 Altering Embroidery speed control
- 3 Centering embroidery motifs
- 4 Calibrating the hoop
- 5 Fabric Thickness
- 6 Function thread removal on/off
- 7 Activating or deactivating securing stitches
- 8 Automatic cut
- 9 Changing the measuring unit

The settings for the upper thread tension **1** and embroidery speed **2** can be adjusted in the same way like the settings for sewing (see page **53**).

- touch the desired icon

Embroidery settings

Centering or opening embroidery motifs in the original position

When the embroidery motif is opened on the machine, it is always centered to the embroidery hoop. If you want the embroidery motif to be opened in its original position (defined by the BERNINA embroidery software), the function «Center the embroidery motif» must be activated.



- touch the icon «Center the embroidery motif»
- press the switch in the right section
- ▶ a previously moved embroidery motif which has been saved in the new position is opened in the saved position after selecting
- press the switch in the right section again
- ▶ the embroidery motif is centered to the embroidery hoop

Calibrating the embroidery hoop

The calibration of the embroidery hoop is the coordination of the needle to the center of the embroidery hoop.

Prerequisite:

The embroidery module is connected and the embroidery hoop with the appropriate embroidery template is attached

- touch the icon «Setup Program»
- touch the icon «Embroidery settings»
- touch the icon «Calibrate the hoop»
- ▶ the machine recognizes the embroidery hoop automatically
- touch the icon «Delete» (1) to delete the present calibration
- center the needle via the arrow icons on the display

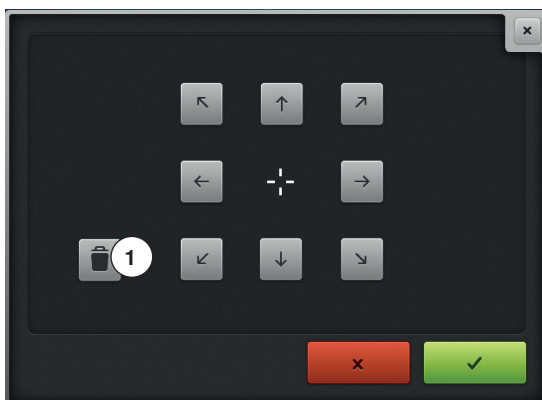

Setup-Program



Fabric Thickness

- touch the «Fabric thickness»-icon
- if the fabric 7 is thicker than 4 mm, e.g. toweling, select 7.5 mm-icon or 10 mm-icon
 - ▶ this ensures that the embroidery hoop is only moved when the needle is no longer in the material
 - ▶ when the embroidery computer is switched off and then restarted again, the setting is 4 mm



Function thread removal on/off

To bring up the thread end after cutting and to pull it out of the fabric, the function must be activated. As for embroidery motifs with long stitches it is recommended to deactivate the function thread removal.

- touch the icon «Thread removal»



- touch the switch using the touchscreen pen/finger to activate the function thread removal
- touch the switch using the touchscreen pen/finger again to deactivate the function thread removal

Programming the securing stitches

Embroidery motifs are programmed either with or without securing stitches. The machine recognizes when no securing stitches are programmed and adds some. If securing stitches are not wanted, they can be deactivated.



- touch the icon «Setup Program»
- touch the icon «Embroidery settings»
- touch the icon «Securing stitches on/off»



- press the switch in the upper right section to deactivate the securing stitches at the start
 - ▶ if the embroidery motif has programmed securing stitches, they will be embroidered
 - ▶ if the embroidery motif doesn't have any programmed securing stitches, none are embroidered
- press the switch again to activate the securing stitches at the start
 - ▶ if the embroidery motif has programmed securing stitches, they will be embroidered
 - ▶ if the embroidery motif doesn't have any programmed securing stitches, the securing stitches are added and will be embroidered
- press the switch in the lower right section to deactivate the securing stitches at the end
 - ▶ if the embroidery motif has programmed securing stitches, they will be embroidered
 - ▶ if the embroidery motif doesn't have any programmed securing stitches, none are embroidered
- press the switch again to activate the securing stitches at the end
 - ▶ if the embroidery motif has programmed securing stitches, they will be embroidered
 - ▶ if the embroidery motif doesn't have any programmed securing stitches, the securing stitches are added and will be embroidered

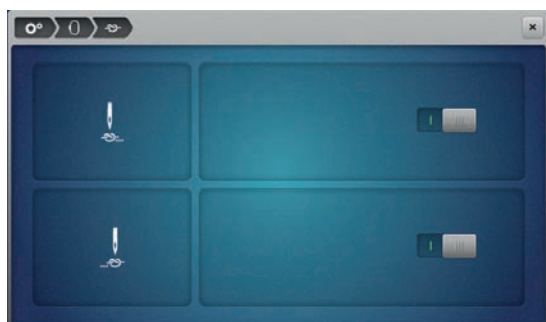

Adjusting the thread cut

The settings for the thread cut can be customized. Deactivate the thread cut after a color change **8** or adjust the length of the connecting stitch **10**. The machine does the cutting of the connecting threads at the determined length for you. Please adjust the length first from where the connecting stitches are to be cut.



The length of the connecting thread can be adjusted between 1 mm and 15 mm, the default setting is 6 mm. This means that all connecting stitches longer than 6 mm are cut automatically. If the value is reduced to 1 mm, more thread cuts are carried out, it takes longer to embroider and more loose thread ends can be seen on the wrong side of the fabric, especially when the function 'Thread-away' is activated too.

On the right side of the fabric there will be practically none or merely very short connecting stitches which results in a wonderful stitch formation.

Reducing the length of the thread cut to 1 mm is particularly of advantage when embroidering texts where usually many short connecting threads occur.

As for other embroidery motifs (specifically when both sides of the embroidery motifs are visible) it may be reasonable to not reduce the length of the thread cut so much so that there won't be too many loose thread ends on the wrong side of the fabric. These loose ends get sewn over and can hardly be removed afterwards.

Always adjust the length of the connecting stitches first. Then select the embroidery motif.

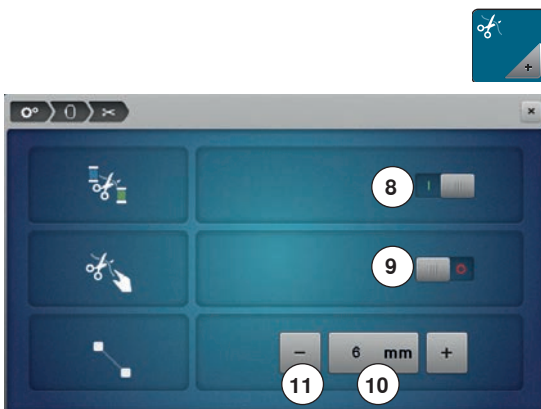

- touch the «Thread cut»-icon
- touch icon **8**
 - ▶ when changing the thread color the automatic cut of the thread is activated or deactivated
- touch icon **9**
- touch the switch in the middle section of the display so that the machine will stop after about 7 stitches and the remaining thread can be cut manually
 - ▶ touch the icons «->» or «+» **11** to adjust the length from where the connecting stitches are cut

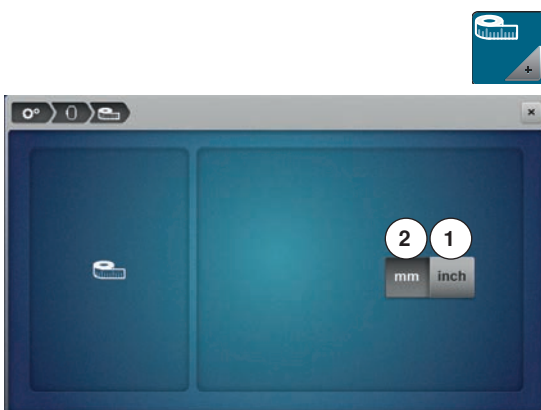

Changing the measuring unit

The measuring unit in the embroidery mode can be changed from mm to inch. The standard setting is in mm.

- touch the icon «Change measuring unit»
 - ▶ touch the icon «Inch» **1** to change the measuring unit in the embroidery mode to inch
 - ▶ touch the icon «mm» **2** to change the measuring unit in the embroidery mode to mm

Personal settings



- select «Personal setting»-icon
- select the desired Display and wallpaper color

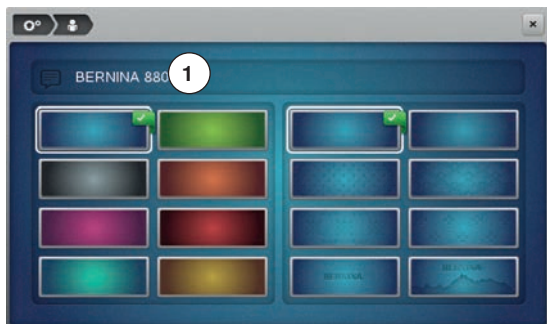

- touch the «Text»-icon 1



Welcome text

- create or change Welcome Text 2
- Space bar is at the bottom of the letter keys.
- ▶ Welcome text appears in the text icon 2 above the letter keys
- touch ✓ to confirm

Deleting Welcome text

- touch the «Text»-icon 2
- ▶ all entered text is deleted

Corrections

- touch icon 3
- ▶ the entered text is deleted from right to left

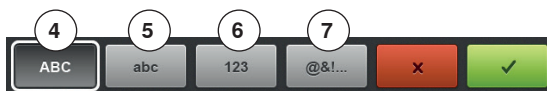

- 4 «ABC» upper case characters (standard)
- 5 «abc» lower case characters (standard)
- 6 «1,2,3» numbers and mathematical characters
- 7 «@&!...» special characters

Monitoring



- touch the «Monitoring»-icon

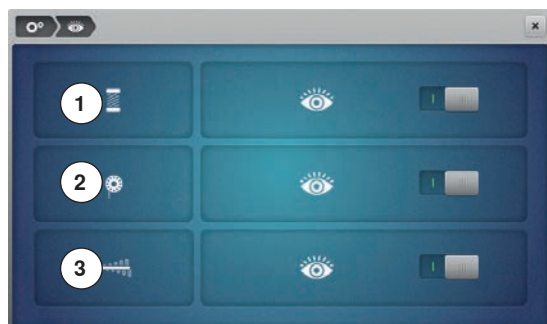

The following monitoring functions can be activated or deactivated:

- 1 Upper thread indicator
- 2 Lower thread indicator
- 3 Optimal interlocking of upper and lower thread

Upper-/Lower thread indicator/Thread knots

- ▶ open eye = function active
- touch gray icon
- ▶ closed eye = function inactive

The sound type for the monitoring functions is set in the audio settings of the functions.

Altering the acoustic signals



Selecting Stitch Pattern/Function/BSR

- touch the «Acoustic signal»-icon

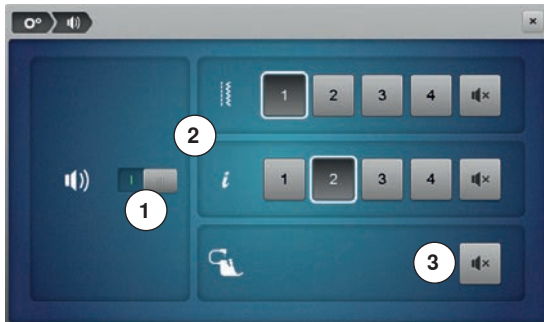

By touching **1** the signals are activated or deactivated.

Stitch patterns and function selection **2** can be confirmed acoustically.

- select the desired sound for the stitch patterns/functions by touching the sound icon 1-4
- activate or deactivate the sound for quilting with BSR by touching the «Loudspeaker»-icon **3**
- touch the «Loudspeaker»-icon
- ▶ the sounds are deactivated for the respective category

Sewing computer settings



- touch the «Sewing computer settings»-icon



- 1 Language selection
- 2 Display settings
- 3 Calibrating the Display
- 4 Basic settings
- 5 Cleaning/Update
- 6 Information



Language selection

- touch the «Language selection»-icon

- select the desired language





Display settings

- touch the «Display setting»-icon



Brightness

- move the slider **1** in the upper part of the Display to the left/right using the Touchscreen pen or the finger or
- turn the stitch width knob or
- touch the «+»/«-»-icon
- ▶ the brightness of the Display changes
- ▶ the basic setting is displayed by a small white dot
- ▶ alterations are visible in the yellow-framed icon

Sewing light

- ▶ when icon **2** is active, the sewing light is on
- touch gray icon
- ▶ the sewing light is turned off

Brightness sewing light

- move the slider **3** in the Display to the left/right using the Touchscreen pen or the finger or
- turn the stitch length knob or
- touch the «+»/«-»-icon
- ▶ the brightness of the sewing light changes
- ▶ the basic setting is displayed by a small white dot
- ▶ alterations are visible in the yellow-framed icon



The Display calibration can be opened as follows:

- turn off the sewing-/embroidery computer
- touch the two needle positioning buttons on the front panel and keep them pressed
- turn on the sewing-/embroidery computer and release the buttons as soon as the Display appears



Display Calibration

- touch «Display calibration»-icon



- touch the center of the cross using the Touchscreen pen
- ▶ the cross moves to the next position
- repeat this until all three positions shown are calibrated
- ▶ the Display closes
- ▶ the calibration is saved



Basic setting

- touch the «Basic settings»-icon



Back to basic setting

Choose from following options:

- 1 Reset Sewing
- 2 Reset Embroidery
- 3 Reset All

- touch the icon, whose settings should be reset to basic setting
- having touched Reset Sewing, also deletes the data in the personal program
- touch ✓ to confirm
- ▶ having touched Reset All, the sewing computer must be restarted



Delete user data

Choose from following options:

- 4 Sewing «Personal program»
- 5 Embroidery «My Designs»
- 6 Embroidery «USB stick» (the USB stick must be inserted in the sewing computer)

- touch the icon, whose data should be deleted
- touch ✓ to confirm
- ▶ the data is deleted

Exceptions:

Thread tension, brilliance, brightness, display color and speed need to be reset to basic state knowingly according to the corresponding function.

Cleaning/Update



- touch the «Cleaning/Update»-icon



- 1 Calibrating Buttonhole foot No. 3A
- 2 Updating the sewing-/embroidery computer
- 3 Cleaning the thread clamp/Thread catcher
- 4 Lubricating sewing-/embroidery computer
- 5 Packing position
- 6 Setting the clock



Calibrating Buttonhole foot No. 3A

- touch the «Calibration»-icon



- attach Buttonhole foot No. 3A
 - press «Start/Stop»-button
 - ▶ the Buttonhole foot No. 3A moves forward and backwards
 - ▶ the Buttonhole foot No. 3A is calibrated and the sewing computer indicates whether the calibration has been successful
- The Buttonhole foot No. 3A is calibrated to this sewing computer and should only be used on this sewing computer.

Updating the sewing-/embroidery computer

ATTENTION!

Do not remove the BERNINA USB stick until there is a message which indicates the end of the update.



- insert BERNINA USB stick with the new software version
- touch the «Update»-icon

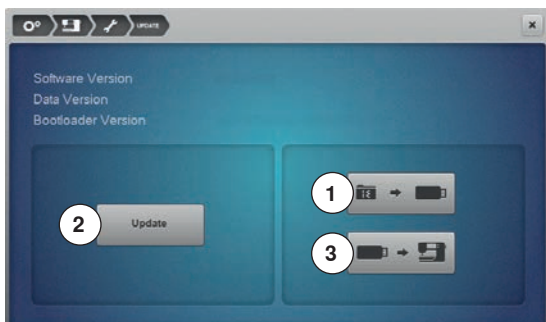

It is recommended to save the data and the settings of the sewing computer before the update is carried out.

- touch icon 1
- ▶ the data of the sewing computer is saved on the USB Stick
- touch the «Update»-icon 2 to start the procedure

It is then checked if:

- ▶ a BERNINA USB stick is inserted
- ▶ there is enough free space available
- ▶ the correct software version is on the stick
- ▶ the data and settings are accepted

After the successful update a message appears and sewing-/embroidery computer is ready for use.

- ▶ if the update cannot be started or if there are problems during the update process, an error message appears

If the data and the settings aren't on the sewing computer anymore after the update:

- touch icon 3
- ▶ the data on the stick are saved on the sewing computer



Cleaning the thread clamp/Thread catcher

- touch the «Cleaning»-icon



Cleaning the thread clamp

- touch icon 1



- clean the thread clamp according to the instructions



Cleaning the thread catcher

- touch icon 2

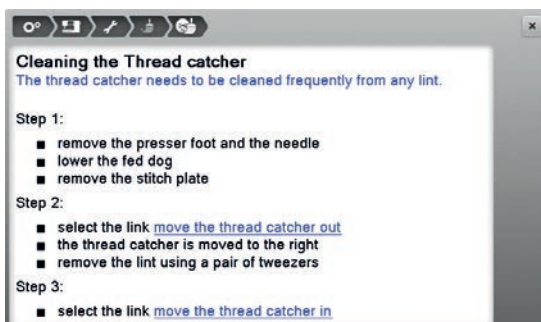

- clean the thread catcher according to the instructions

Setup-Program



Lubricating the machine

- touch the icon «Lubricating the machine»
- lubricate the machine according to the instructions on the display

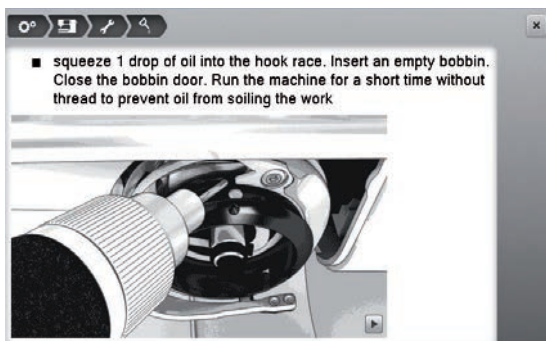

Packing position

Do not move the embroidery arm of the embroidery module by hand. Follow the on-screen instructions to fit the embroidery module back into its original packaging.

- touch the «Packing position»-icon

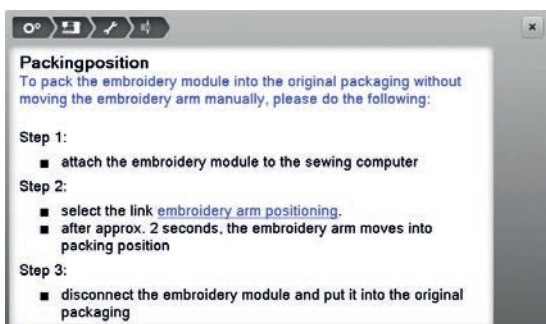

Setting the clock

- touch the «Clock»-icon
- turn the stitch width knob or
- touch the «+»/«-»-icon below the hour Display
 - ▶ the hours **1** are set
- turn the stitch length knob or
- touch the «+»/«-»-icon below the minute Display
 - ▶ the minutes **2** are set



Standard = hours are displayed on the scale of 0-24.

- touch icon **3**
 - ▶ hours are displayed on the scale of 0-12
- touch icon **4**
 - ▶ am = the displayed hours 0-12 ante meridiem
- touch icon **5**
 - ▶ pm = the displayed hours 0-12 post meridiem

Information



Information

- touch the «Information»-icon



- 1 Version
- 2 Dealer details
- 3 Service data
- 4 ID Number
- 5 Upgrade



Version

- touch the «Version»-icon

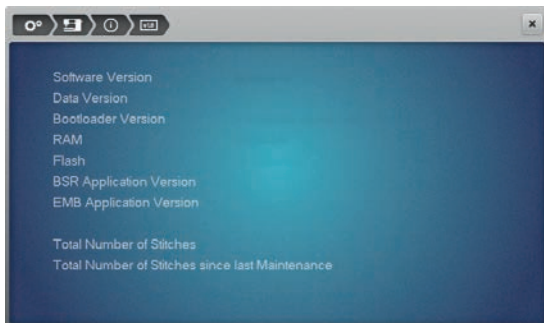

- ▶ the present version of the sewing computer and the attached embroidery module are visible
- ▶ the total number of stitches and the number of stitches sewn since the last servicing by the dealer are displayed



Dealer details

- touch the «Dealer details»-icon

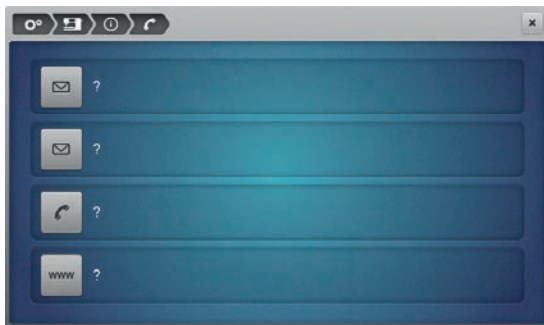

- touch respective icon
- Following details of the BERNINA-dealer can be registered:
- store name
 - address
 - telephone number
 - website or e-mail address



Service data

- touch «Service data»-icon

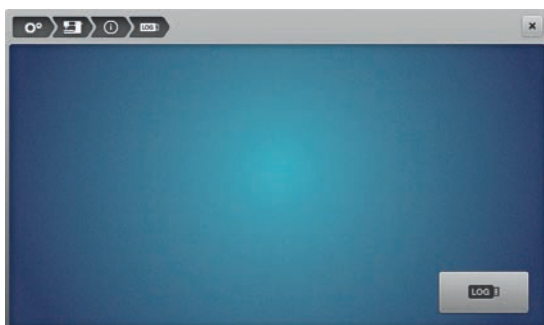

- The service data of the present condition of the sewing-/embroidery computer can be saved on a USB stick and sent to the BERNINA-dealer:
- insert USB stick to sewing-/embroidery computer
 - touch the «LOG»-icon
 - ▶ data is saved on the USB stick
 - remove USB stick

Setup-Program



ID Number

- the ID number of the machine is displayed
- touch the icon «ID Number»
- ▶ the machine ID number appears

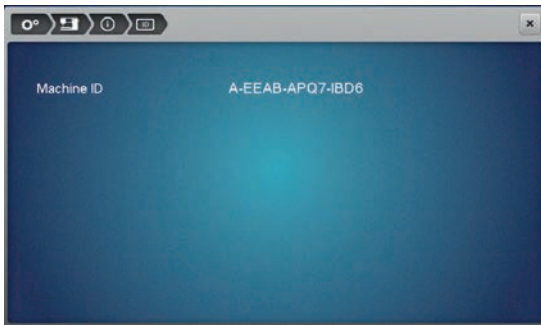

UPGRADE

- the upgrade is fee-based and has to be activated via an activation key
- touch the icon «UPGRADE»
- ▶ enabled means that the update has been successful

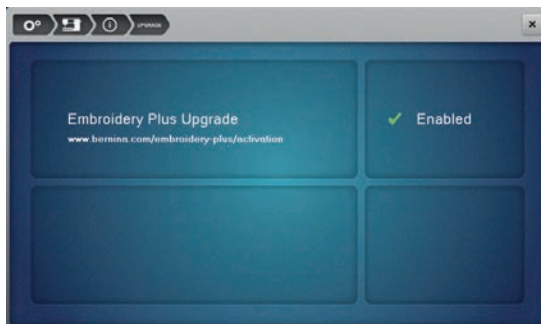

Tutorial

Overview Tutorial

The tutorial provides information and explanations about the different areas of sewing.



- touch the «Tutorial»-button
- ▶ «Tutorial»-Display appears



- 1 Threading
- 2 Sewing techniques
- 3 BSR
- 4 Embroidery
- 5 Embroidery Techniques
- 6 Presser foot
- 7 Buttonholes
- 8 Quilting
- 9 Needle
- 10 Miscellaneous
- 11 Free Hand System (FHS)
- 12 Trouble Shooting

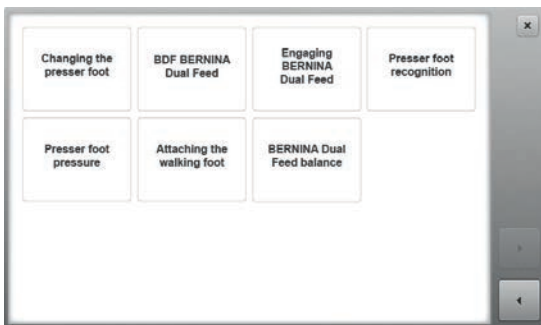

- select desired topic, e.g. presser foot
- ▶ topic overview about the presser foot appears
- select desired topic, e.g. changing the presser foot

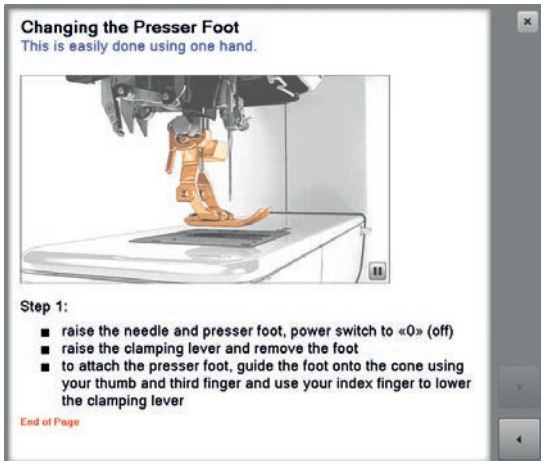

- ▶ information on the desired topic is shown
- scroll through the topics using the knobs or the finger



- touch «Next»
- ▶ the next page appears



- touch «Back»
- ▶ the previous page appears

- touch «Close»-icon
- ▶ the «Tutorial»-Display closes
- ▶ the previous Display appears

Creative Consultant

Overview Creative Consultant

The creative consultant provides information and help with various sewing techniques. After selecting the fabric and the desired sewing technique suggestions for suitable needles, presser feet etc. are displayed.

▶ presser foot pressure and upper thread tension are set automatically



- touch the «Creative-/Embroidery Consultant»-button
- ▶ «Creative Consultant»-Display appears

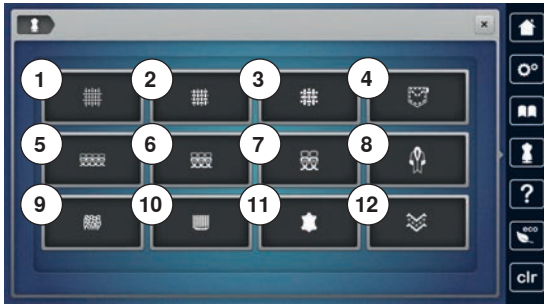

- 1 Light weight woven
- 2 Medium weight woven
- 3 Heavy weight woven
- 4 Denim
- 5 Light weight knit
- 6 Medium weight knit
- 7 Heavy weight knit
- 8 Fur
- 9 Toweling
- 10 Fabric with a pile
- 11 Leather and Vinyl
- 12 Tulle and Laces

Overview Sewing techniques/Recommendations



- touch icon of the desired material, e.g. light weight woven

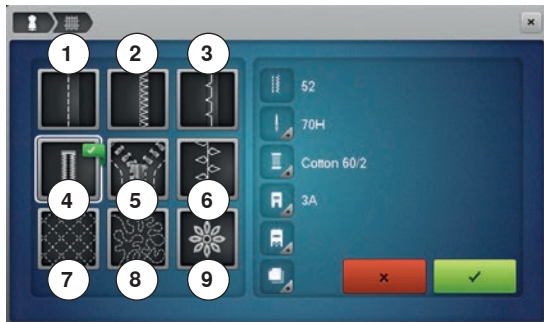

- 1 Seams
- 2 Overcasting
- 3 Blind hem
- 4 Buttonhole
- 5 Zipper
- 6 Decorative stitching
- 7 Machine quilting
- 8 Free-motion stitching
- 9 Appliqué

- select the desired sewing technique, e.g. buttonhole
- If the desired sewing technique is not in the list, choose a similar sewing technique.

▶ recommendations for the selected material and the desired sewing technique are displayed

- touch ✓ to confirm

▶ the Display with the programmed stitch patterns appears

Leaving the Creative consultant

- touch ✗

Help Program

The Help Program provides information about individual stitch patterns and function icons in the Display.



- touch the «Help Program»-button
- select the desired stitch pattern or the desired function

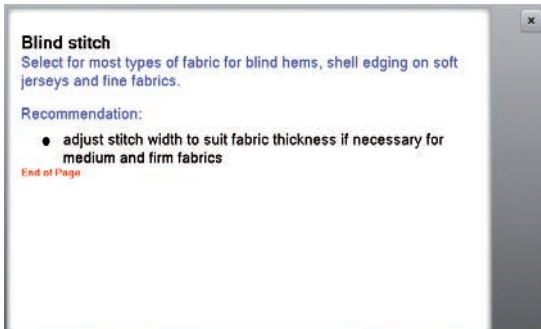

Stitch patterns

The Display shows the following information:

- ▶ stitch pattern name
- ▶ suitable materials
- ▶ recommendation

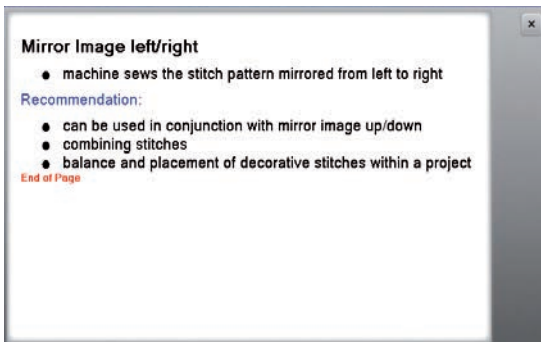

Functions

The Display shows the following information:

- ▶ function name
- ▶ function explanation
- ▶ recommendation



Leaving the Help Program

- touch the «Close»-icon
- ▶ the Help program is closed
- ▶ the previous Display appears

Balance

Practical and decorative stitches, alphabets

The sewing computer is tested and optimally set before it leaves the BERNINA factory. Different fabrics, threads and stabilizers can affect programmed stitches so that they are not sewn out properly. These effects can be corrected with the electronic Balance so that the stitch formation can be adjusted where necessary to suit the material.



- touch the «i»-icon
- touch the «Balance»-icon



Practical and decorative stitches

- ▶ in the left part of the Display the stitch pattern is shown as it is set originally (programmed)
- ▶ in the right part of the Display any alterations are directly visible



Corrections

The stitch sewn on the fabric (e.g. the Honeycomb stitch) opens up and it does not look correct:

- adjust the stitch pattern length via the stitch length knob or «+»/«-»-icons, until the stitch in the right part of the Display is identical with the stitch on the fabric
- ▶ the alteration is shown with a number in the yellow-framed icon
- touch the «Close»- or «i»-icon
- ▶ alterations are saved
- ▶ the previous Display appears



Sideways-motion patterns

- ▶ in the left part of the Display the stitch pattern is shown as it is originally programmed
- ▶ in the right part of the Display any alterations are directly visible



The stitch sewn on the fabric e.g. stitch pattern No. 212 is vertically and horizontally distorted.

Vertical corrections

- adjust the stitch pattern length via the stitch length knob or «+»/«-»-icons, until the stitch in the right part of the Display is identical with the stitch on the fabric

Horizontal corrections

- adjust the stitch pattern width via the stitch width knob or «+»/«-»-icons, until the stitch in the right part of the Display is identical with the stitch on the fabric

Back to basic settings

- touch the «i»-icon
- touch the yellow-framed «Balance»-icon
- touch the yellow-framed icon
- ▶ basic setting is reset

BERNINA Dual Transport



- touch the «i»-icon
- touch the «Balance Dual Transport»-icon

Balance BERNINA Dual Transport

The top fabric layer is fed too little (the bottom layer extends past the cut edge) = it becomes longer in relation to the bottom fabric layer:

- turn the stitch width knob clockwise or
 - touch the «+»-icon or
 - move the slider in the Display up using the finger or the Touchscreen pen
 - ▶ the feed of the top fabric layer is increased and the relocation is balanced
- The top fabric layer is fed too strongly = the bottom layer is shorter than the cut edge:

- turn the stitch width knob counterclockwise or
- touch the «-»-icon or
- move the slider in the Display down using the finger or the Touchscreen pen
- ▶ the feed of the top fabric layer is decreased and the relocation is balanced

Back to basic setting

- touch the yellow-framed icon
- ▶ returns to basic setting

A white rectangular button with a red dot at the top center and the word "eco" printed in the center.

eco

eco description

When the work is interrupted for longer periods, the sewing-/embroidery computer can be put into energy-saving mode.



Activating eco

- touch the «eco»-button
- ▶ the Display gets dark
- ▶ power consumption is reduced and the sewing light turns off

Deactivating eco

- touch the «eco»-button
- ▶ the sewing-/embroidery computer is ready for use



The energy-saving mode also acts as a child safety feature. The Display is inactive and the sewing-/embroidery computer cannot be started.

Practical stitches

Overview Practical stitches

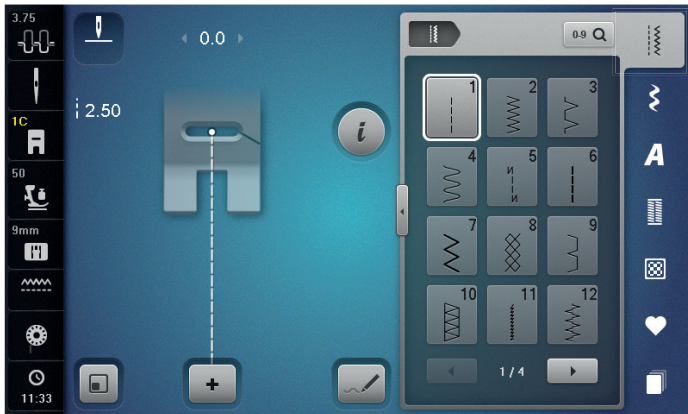

- touch the «Practical stitch»-button
- ▶ the practical stitches are visible in the Display
- further practical stitches are visible by scrolling



1 Straight stitch

For non-elastic materials; all straight stitch work, such as seams, topstitching, sewing zippers



2 Zig-zag

Zig-zag work such as overcasting edges, attaching elastic and lace



3 Vari overlock

For fine jerseys; stretch overlock seams, hems and stretch seams



4 Running stitch

Most types of fabric; mending, patching, reinforcing seams, etc.



5 Securing Program

For all materials; secures the beginning and end of seams by straight stitching



6 Triple straight stitch

Reinforced seams in heavy fabrics, visible seams and topstitching



7 Triple Zig-zag

Reinforced seams in heavy fabrics; visible hems and seams



8 Honeycomb stitch

For all types of jersey and smooth materials; visible seams in lingerie, clothing, linen, mending etc.



9 Blind stitch

For most types of materials; Blind hems; shell edging effect on soft jerseys and fine material; decorative seams



10 Double overlock

For any knit materials; overlock seam = sewing and finishing in one step



11 Super stretch stitch

For highly elastic fabrics; highly elastic open seam for all types of clothing



12 Gathering stitch

Most types of fabric; gathering with shirring elastic. Butted seams = butting two pressed edges and sewing together, decorative stitches

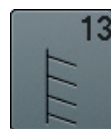

13 Stretch overlock

For medium weight knits, toweling and firm woven; overlock seams, flat joining seams



14 Jersey stitch

For jersey materials; visible hems, visible seams in lingerie, sweaters, mending jersey



15 Universal stitch

For firm fabrics such as felt and leather; flat joining seams, visible seams, attaching elastic, decorative seams



16 Sewn-out Zig-zag

Edge finishing and reinforcing, attaching elastic, decorative seam



17 Lycra stitch
All two-way stretch fabrics; flat joining seams and hems, reinforced seaming on underwear



29 Blindstitch narrow
For blind hems in fine materials

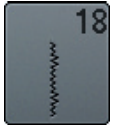

18 Stretch stitch
For highly elastic fabrics; open seam for sportswear

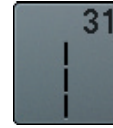

31 Triple Straight stitch with long stitch
Reinforced seams in heavy fabrics, visible hems and seams



19 Reinforced overlock
For medium-weight knitware and toweling; overlock seams, flat joining seams

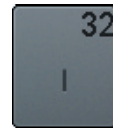

32 Single Straight stitch
As a connecting stitch between two individual decorative stitch patterns in a combination



20 Knit overlock
For knit material, hand- and machine made items; overlock seam = sewing and finishing in one step



33 Three Single Straight stitches
As a connecting stitch between two individual decorative stitch patterns in a combination



21 Basting stitch
Basting seams, hems, etc. temporarily



34 Darning stitch
Use for darning in conjunction with the «Permanent Reverse» function



22 Simple darning program
Automatic darning of fine to medium weight materials



35 Finished edge overlock
For sewing a seam and reinforcing in one step with medium weight knits



23 Reinforced darning program
Automatic darning of firm materials



36 Overlock
For medium weight knits



24 Bartack Program
Reinforcing pocket openings, sewing belt loops etc.



37 Reinforced overlock
For sewing a seam and reinforcing in once step with medium weight knits



25 Bartack Program
Reinforcing pocket openings, sewing on belt loops, securing zippers and seam ends



38 Chainstitch
Decorative reinforcement stitch for most woven fabrics



26 Large Fly stitch
For medium weight to thick materials; reinforcing pocket openings, zippers and slits



39 Cover stitch effect
For decorative seams and hems on firm knitted and woven fabrics



27 Small fly stitch
For fine to medium weight fabrics; reinforcing pocket openings, zippers and slits



40 Cover stitch effect
For decorative seams and hems on firm knitted and woven fabrics

Selecting stitch pattern

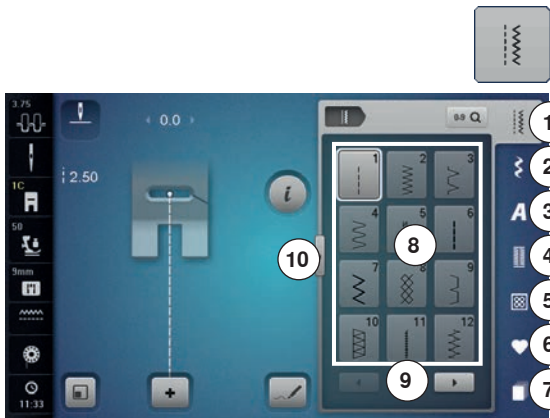

Direct-Option 1

- select the desired main category 1-5

- 1 Practical stitches
- 2 Decorative stitches
- 3 Alphabets
- 4 Buttonholes
- 5 Quilt stitches
- 6 Personal program/Memory
- 7 History

- ▶ the available stitch patterns are visible in the Display area 8
- select desired stitch pattern
- further stitch patterns are visible by scrolling 9



Direct-Option 2

- select the desired main category 1-5

- touch icon 10
- ▶ the stitch menu expands
- ▶ the number of the visible stitches is much bigger
- ▶ all the other stitch patterns become visible by touching the scroll icons
- ▶ the categories, e.g. of decorative stitches, are visible directly
- touch the icon 10 again
- ▶ the Display view is reset



By stitch number

- touch the «0-9»-icon

- ▶ numbers for entering are visible in the Display area 13
- enter stitch number
- ▶ the entered stitch number appears in the window 11
- touch icon 12
- ▶ last digit is deleted
- touch icon 11
- ▶ complete number is deleted
- touch icon 14 to confirm

Cancelling

- touch the «0-9»-icon or
- touch icon 15
- ▶ the previous Display appears



An invalid stitch number will be indicated in icon 11 with 3 question marks.

Customizing stitch patterns individually

A stitch pattern can be individually altered according to the fabric and the application. The adjustments described here are applicable for all practical and many decorative stitches.



The personal memory is unlimited; it can hold as many stitch alterations as needed:

- Stitch length
- Stitch width
- Needle position
- Pattern extend
- Mirror Images
- Long stitch function
- Thread tension
- Balance
- Pattern repeat 1-9x

Temporary Altered Stitch Memory

Any altered stitch width and stitch length is automatically saved.

Example:

- sew with an altered stitch (e.g. zig-zag)
- select and sew another stitch, e.g. straight stitch
- when selecting the individually altered zig-zag again, your alterations are still active

Return to basic settings

Individual stitch patterns can be reverted to basic settings manually.

- select the stitch width/stitch length Display and touch the yellow-framed icon in the respective Display or
- touch the «-»/«+»-icon or
- move the slider in the Display using the Touchscreen pen or the finger or
- press «clr»-button
- ▶ any altered values of the **active** stitch return to basic setting
- switch off the sewing computer
- ▶ any alterations of all stitches are deleted

Personal memory permanent

The basic settings programmed by BERNINA can be altered and saved and remain active even when the sewing computer is switched off.



Altering basic settings

- select stitch pattern, e.g. zig-zag
- alter stitch width and stitch length via the knobs



Saving alterations

- touch the «i»-icon
- touch the «Save»-icon
- touch the «Close»- or «i»-icon
- ▶ the alterations are saved



Return to basic settings

- touch the «i»-icon
- touch the «Reset»-icon
- touch the «Close»- or «i»-icon
- ▶ the basic setting is reset

Altering stitch width and stitch length



- turn the knobs or
 - touch stitch width or stitch length Display
 - touch the «-»/«+»-icon in the respective Display or
 - move the slider in the Display using the Touchscreen pen or the finger
- Can be altered while sewing.



When sewing practical or quilting stitches the actual stitch length **1** is displayed.



With other stitch patterns, including alphabets, the overall length of a stitch pattern **2** is displayed. The actual stitch length **3** is only visible when the stitch length Display is opened.

Application Examples of Practical Stitches

Straight stitch

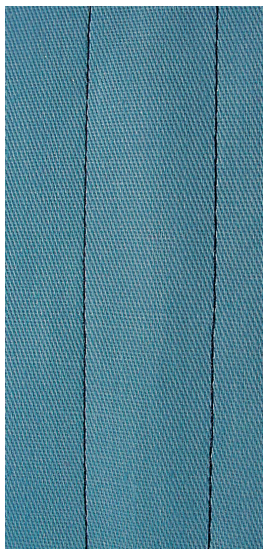

Reverse pattern foot No. 1C/1D

Straight Stitch No. 1

After turning on the sewing computer the straight stitch will appear.
▶ the needle is up

Application

Suitable for all fabrics.



Adjust the stitch length to suit the fabric

E. g. use a longer stitch length (approximately 3-4 mm) with denim, a shorter length with fine fabric (approx. 2-2.5 mm).

Adjust the stitch length to suit the thread

E. g. use a longer stitch length when using cordonnnet thread for topstitching (approx. 3-5 mm).

Activate needle stop down

This prevents the fabric from shifting when you adjust or pivot the sewing project.

Triple Straight Stitch

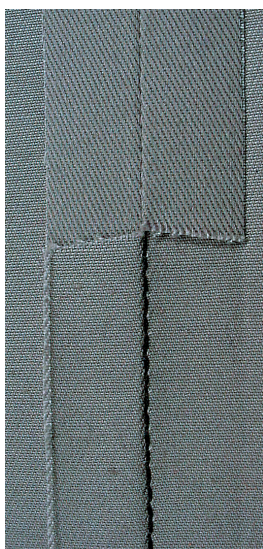

Reverse pattern foot No. 1C/1D

Triple straight stitch No. 6

Open seam

Durable seam for firm or dense materials such as denim and corduroy.



For firm or densely woven materials

A Jeans needle and Jeans foot No. 8 will help when sewing denim or canvas.

Decorative top stitch

Lengthen stitch and use the triple straight stitch for decorative topstitching.

Triple Zig-zag

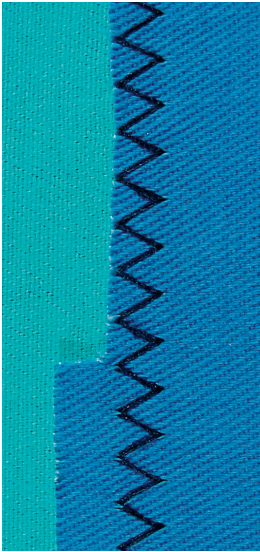

Reverse pattern foot No. 1C/1D

Triple Zig-zag No. 7

In firm materials, particularly for denim, deckchair covers, awnings.



Seams on often washed items. Finish raw edges first. Use Jeans needle for very firm materials.

Zipper

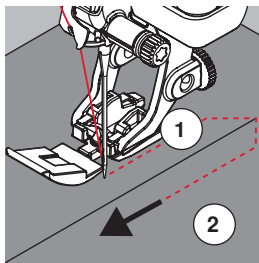
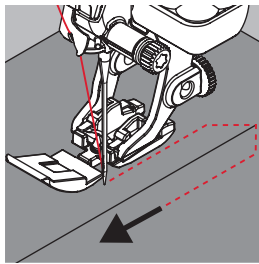
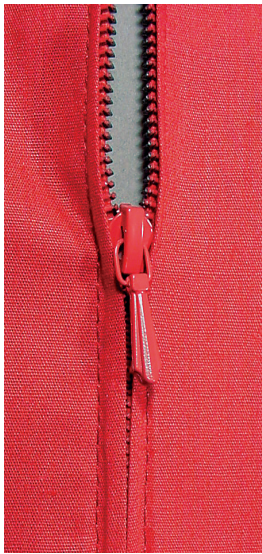

Zipper foot No. 4D

Straight stitch No. 1

Preparation

- close seam to the zipper beginning
- sew securing stitches
- baste seam closed and clean
- finish the seam allowance
- iron the seam
- open the zipper
- baste the zipper: baste or pin zipper in place so that fabric folded edges meet over the center of the zipper

Sewing in the zipper

- open zipper a little
- move needle position to the right
- start sewing from top left
- position the foot so the needle stitches along the edge of the zipper coils
- stop in front of the pull (needle position down)
- raise the presser foot
- close the zipper again
- continue to sew, stop in front of the base of the zipper, needle position down
- raise the presser foot
- turn the sewing project
- sew across the seam, stop with needle position down
- raise the presser foot
- turn sewing project again
- sew the second side from bottom to top

Variation: Sew both sides of zipper from bottom to top

Suitable for all fabrics with nap or grain (e.g. velvet).

- prepare zipper as described above
- start sewing in the center of the seam at the end of the zipper, needle position on the right
- sew diagonal along the edge of the zipper coils
- first side **1** sew from bottom to top
- move needle position to the left
- second side **2** sew in the same way from bottom to top



Sew around the zipper pull

- sew up to about 5 cm away from the zipper pull
- stop with the needle down, raise the presser foot, open the zipper, finish sewing (use Free Hand System)

Starting to sew

- hold thread firmly when starting to sew = pull fabric slightly to the back (fewer stitches) or
- sew about 1-2 cm reverse first, and continue to sew as usual

Zipper or fabric is thick or densely woven

For even stitch formation use a 90-100 needle.

Manual darning

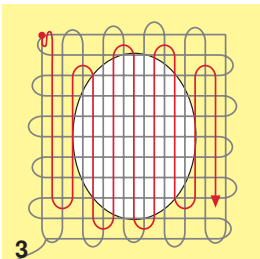
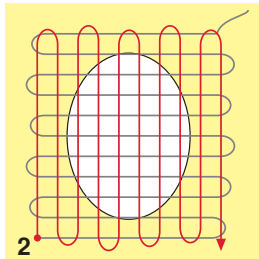
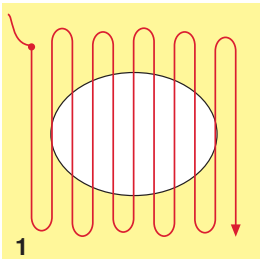
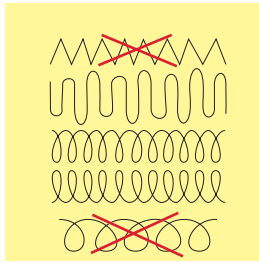

Darning foot No. 9 (optional accessory)

Straight stitch No. 1

Holes or worn areas

«Replacing» threads along the lengthside and crosswise in every material.

Preparation

- lower the feed dog
- attach the Slide-on table
- hoop the fabric into the round embroidery hoop (optional accessory)
- ▶ the darning area stays evenly taut and cannot be distorted

Sewing

- work from the left to the right, guide the fabric evenly without using pressure
- move in curves when changing direction on top and on bottom. Avoid points as this can cause holes and thread breakage
- work the rows in irregular lengths. The thread is better spread over the fabric

1 Sew the first rows to cover the hole

- first rows just beyond the worn area and not too close together
- work the rows in irregular lengths
- turn work by a quarter turn -90

2 Sew over the first rows

- first rows not too close
- turn fabric by half turn -180°

3 Finish darning the hole

- sew another loose row



Poor stitch formation

- if the thread is lying on top, slow down the fabric movement
- if there are knots on the wrong side of the fabric, move the fabric more quickly

Thread breaks

Guide the fabric more consistently.

Automatic Darning

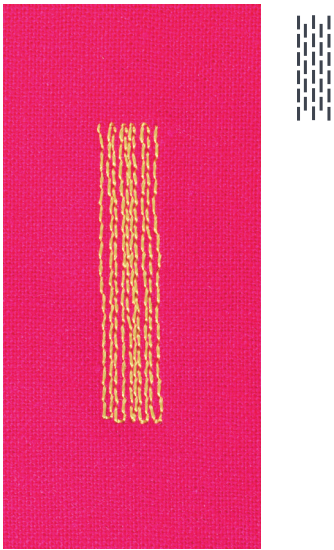

Reverse pattern foot No. 1C
Buttonhole foot No. 3A

Simple darning program No. 22

Quick darning of holes or worn areas

Replaces threads along the lengthwise grain in all materials.

Preparation

- hoop light weight materials in the round embroidery hoop (optional accessory)
- ▶ the darning area stays evenly taut and cannot be distorted

Darning with Reverse pattern foot No. 1C

Start sewing top left.

- sew first row
- stop the sewing computer
- press «Quick reverse»-button
- ▶ the length is programmed
- finish sewing the darning program
- ▶ the sewing computer stops automatically
- press «clr»-button
- ▶ the programmed settings are cleared

Darning with the buttonhole foot No. 3A

- for darning worn and damaged areas
- darning length max. 3 cm
- same procedure as with Reverse pattern foot No. 1C



Reinforcement

Use fine material or (adhesive) interlining as a backing.

If the darning becomes distorted

Correct with the Balance function (more about Balance-Function see page 72).

Reinforced darning, automatic

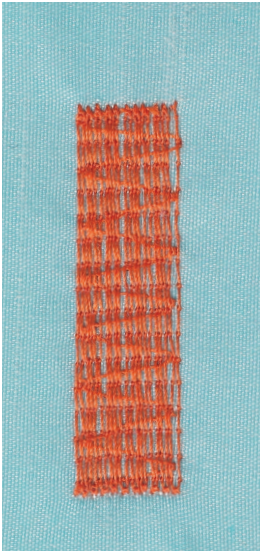

Buttonhole foot No. 3A

Reinforced darning program No. 23

Quick darning of holes or worn areas

Replaces threads along the lengthwise grain in all materials.

Preparation

- hoop light weight materials in the round embroidery hoop (optional accessory)
- ▶ the darning area stays evenly taut and cannot be distorted

Darning with the Buttonhole foot No. 3A

Start sewing top left.

- sew first row
- stop sewing computer
- press «Quick reverse»-button
- ▶ the length is programmed
- finish sewing the darning program
- ▶ the sewing computer stops automatically
- press «clr»-button
- ▶ the programmed settings are cleared



If the darning does not cover the whole worn or damaged area

Reposition the work under the foot to continue covering the worn or damaged area. Begin sewing; the program will repeat as often as desired (the length is saved).

Reinforced Darning program

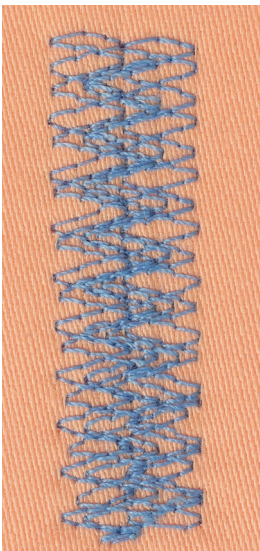

Reverse pattern foot No. 1C

Darning program No. 34

The Darning program No. 34 is particularly useful for mending heavy weight or durable garments, such as jeans and overalls.

Finishing Edges



Reverse pattern foot No. 1C

Zig-zag No. 2

- for all fabrics
- for finishing raw edges
- elastic seams
- decorative sewing

Finishing edges

- guide edge of fabric into the center of the presser foot
- do not select too wide a stitch
- do not select too long a stitch
- needle goes into fabric on one side and over the edge into the air on the other side
- the edge of the fabric should lie flat and not roll
- use darning thread for fine materials

Satin stitch

- dense, short zig-zag (stitch length 0.5-0.7 mm)
- use satin stitch for appliqué, embroidery, etc



As a variation the satin stitch No. 1354 can be used.

Double overlock



Reverse pattern foot No. 1C

Overlock foot No. 2A

Double overlock No. 10

Closed seam

Double overlock seam in loose knits and cross seams in knits and jerseys.



Knits and jersey

- use a new Jersey needle to prevent damaging the loops
- if necessary loosen presser foot pressure

Sewing stretch materials

If necessary use a stretch needle (130/705H-S).

Topstitching edges

Blindstitch foot No. 5
Reverse pattern foot No. 1C
Edge stitch foot No. 10/10C/10D (optional accessory)

Straight stitch No. 1

Narrow edgestitching

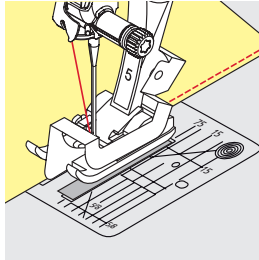

Outer edges

- place edge of fold left against the guide on the blindstitch foot
- select the needle position left in the desired distance to the edge

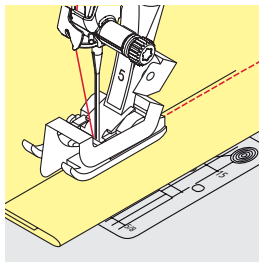

Hem edges

- place edge of fold (inside upper edge of hem) right against the guide on the blindstitch foot
- select needle position to the right to sew along the upper edge



Blindstitch foot No. 5
 Needle position left or far right.

Reverse pattern foot No. 1C and Edge stitch foot No. 10/10C/10D (optional accessory)
 Any needle position possible.

Wide edgestitching

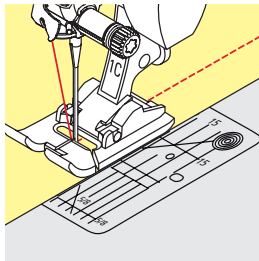

Material guidance

Presser foot as guide:

- guide the folded edge along the edge of the presser foot

Stitch plate as guide:

- guide the folded edge along the marks on the stitch plate (1 to 2.5 cm)

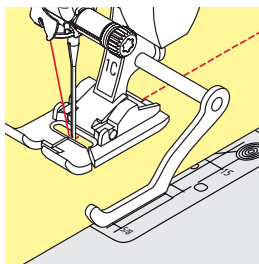

Seam guide as guide:

Presser foot

- loosen the screw on the back of the presser foot
- insert the seam guide into the hole of the presser foot
- adjust width as desired
- tighten the screw
- guide the folded edge along the seam guide

To sew parallel wider lines, guide the seam guide along a previously sewn line of stitches.

Blind Hems

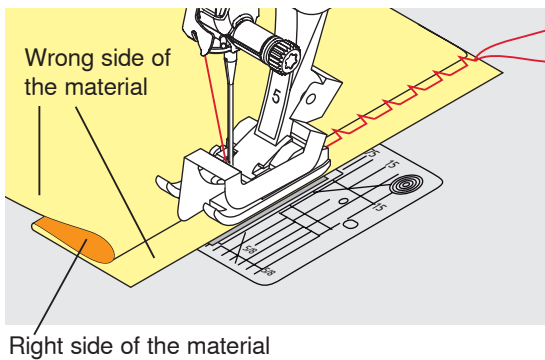
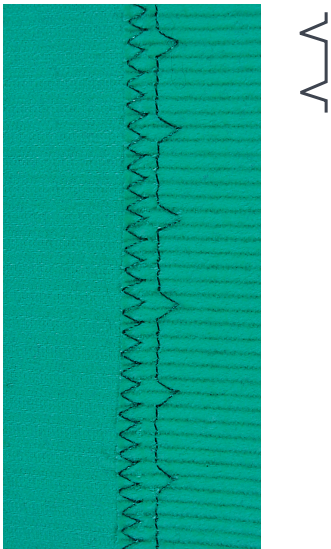

Blindstitch foot No. 5

Blindstitch No. 9

For invisible hems in medium to heavy weight cotton, wool and blended materials.

Preparation

- finish the raw edges
- fold the hem and baste or pin in place

- fold the fabric back over the right side of the fabric to expose the finished lower edge
- place under presser foot and
- move the folded edge against the metal guide on the presser foot

Sewing

The needle should just pierce the edge of the fold, as when hand blind-stitching.

- after sewing about 10 cm, check both sides of fabric and adjust width again if necessary



Fine stitch width adjustment

Guide the folded edge evenly along the metal guide on the foot = even depth.

Visible Hem

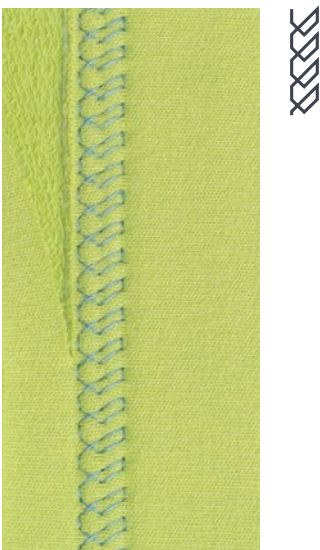

Reverse pattern foot No. 1C/1D

Jersey stitch No. 14

For visible, elastic hems in jersey, cotton, synthetic and mixed fibers.

Preparation

- iron the hem, baste if necessary
- reduce the presser foot pressure if necessary

Sewing

- sew the hem at preferred depth on the right side
- trim excess fabric from the wrong side

Securing Program

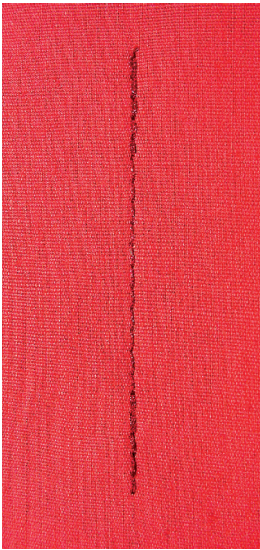

Reverse pattern foot No. 1C

Securing Program No. 5

- for all fabrics
- secures beginning and end of seam

Sewing long seams with straight stitch

Even securing by defined stitch count.

Sewing start

- press the foot control
- ▶ the sewing computer secures automatically when beginning to sew (5 stitches forward, 5 stitches in reverse)
- sew seam with straight stitches in desired length



Sewing end

- press «Quick reverse»-button
- ▶ the sewing computer secures seam automatically (5 stitches in reverse, 5 stitches forward)
- ▶ the sewing computer stops automatically at the end of the securing program

Basting Stitch

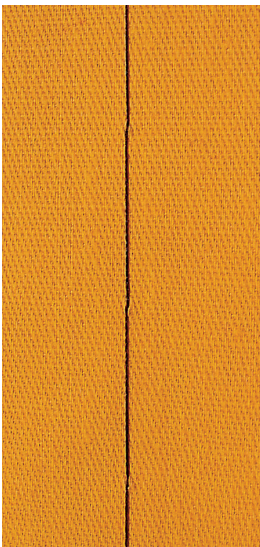

Reverse pattern foot No. 1C/1D

Basting stitch No. 21

- straight stitch, sews out every fourth stitch, i.e. longest stitch possible is 24 mm, when the stitch length is set at 6 mm. Recommended stitch length 3.5-5 mm
- for work which requires a very long stitch
- basting seams, hems, Quilts etc.
- temporary joining
- easy to remove

Preparation

- pin work at a right angle to basting direction
- ▶ to prevent the layers from slipping



Securing/fixing the thread

Sew 3-4 securing stitches at the beginning and at the end.

Thread

Use a fine darning thread for basting as it is easier to remove.

Flat joining seam

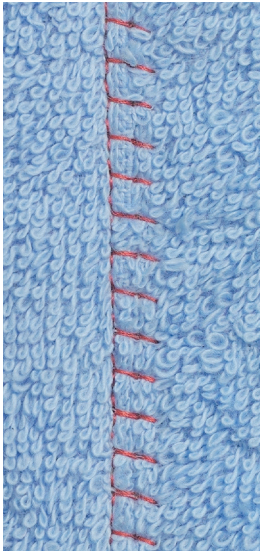

TTTTT

Reverse pattern foot No. 1C

Stretch overlock No. 13

Ideal for fluffy or thick materials such as terry cloth, felt and leather etc.

Sewing

- overlap fabric edges
- sew along the fabric edge
- the needle should sew over the edge of the top layer on the right side
- ▶ very flat durable seam

Height Compensation of uneven layers

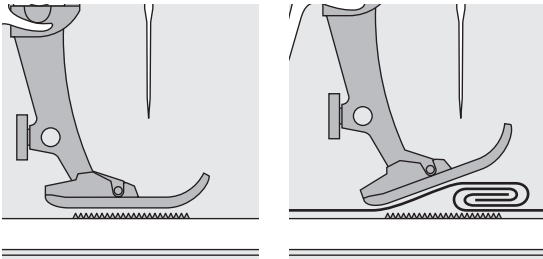

The feed dog works accurately when the foot is level.

If the presser foot is at an angle when sewing over a thick seam, the feed dog cannot grip. The fabric may jam.

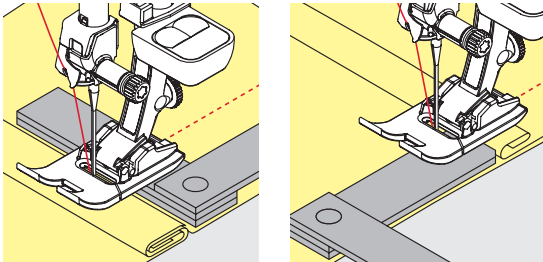

To solve this problem, place one, two or three compensating plates as required behind the needle under the presser foot to level it.

To correct the height in front of the foot, place one or more plates under the foot close to the needle. Sew until the foot is level again and remove the plates.



Needle stop down.

Sewing Corners

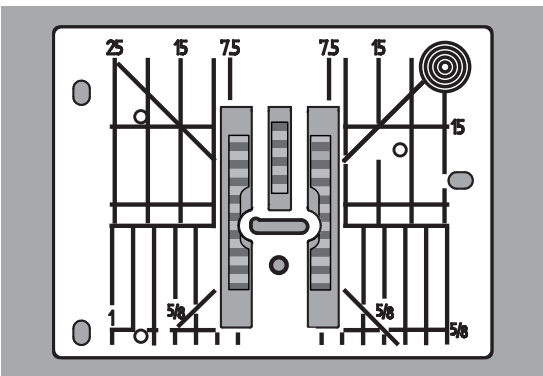

Due to the width of the stitch plate hole the outer feed dog rows are relatively far apart.

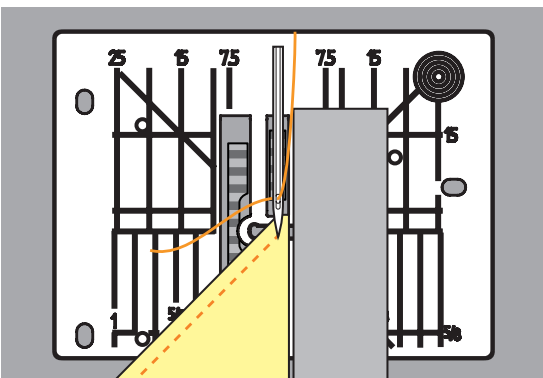

When sewing corners only a small section of the fabric is actually on the feed dog. Therefore it cannot grip the fabric well.

Place one or more plates of the height compensation tool parallel to the presser foot close to the edge of the fabric.

▶ the fabric is fed evenly



Needle stop down.

Buttonholes

Overview Buttonholes

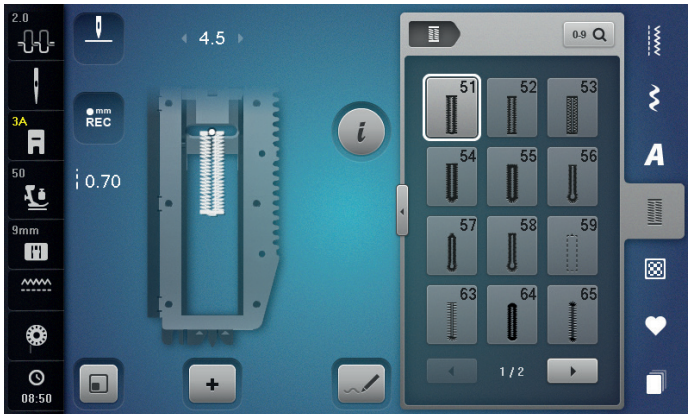

Buttonholes are not only practical closures, they can also be used as a decorative effect. All buttonholes can be programmed and sewn in different ways.

- touch the «Buttonhole»-button
- scroll to see more buttonholes



51 Standard buttonhole
For light to medium weight fabrics; blouses, shirts, trousers, bedlinens, etc.



58 Keyhole buttonhole with horizontal bartack
For firmer, non-elastic materials; jackets, coats, leisure wear



52 Standard buttonhole narrow
For light- to medium weight fabrics; blouses, dresses, children's and baby clothes, crafts



59 Straight stitch buttonhole
Program for staystitching buttonholes, for pocket openings, reinforcing buttonholes; especially for buttonholes in leather and imitation leather



53 Stretch buttonhole
For any highly elastic jersey made from cotton, wool, silk and synthetic fibers



63 Heirloom buttonhole
For light- to medium weight woven fabrics; blouses, dresses, leisure wear, bed linen



54 Round buttonhole with normal bartack
For medium- to heavy weight materials: dresses, jackets, coats, rainwear

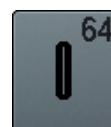

64 Double rounded buttonhole
For medium to heavy weight fabrics of all types



55 Round buttonhole with horizontal bartack
For medium- to heavy weight fabrics of all types: dresses, jackets, coats, rainwear



65 Double rounded Heirloom buttonhole
For light to medium weight woven fabrics, blouses, dresses and bed linens



56 Keyhole buttonhole
For heavy weight, non-stretch materials; jackets, coats, leisure wear



66 Buttonhole with double Pointed Bartack, narrow
Decorative buttonhole for medium weight materials; blouses, dresses, jackets



57 Keyhole buttonhole with pointed bartack
For firmer, non-stretch materials: jackets, coats, leisure wear



67 Double pointed bartack buttonhole
For medium weight woven fabrics, blouses, dresses and jackets



Decorative Keyhole buttonhole with horizontal bartack

For firmer, non-stretch materials: jackets, coats, leisure wear



Decorative buttonhole with double pointed bartack

For decorative buttonholes in firmer, non-elastic fabrics



Decorative Stretch Buttonhole

For light to medium weight knits



Button sew-on program

For buttons with 2 and 4 holes



Eyelet with small zig-zag

Openings for cords and narrow ribbons, decorative work



Straight-stitch eyelet

Openings for cords and narrow ribbons, decorative work

Important information

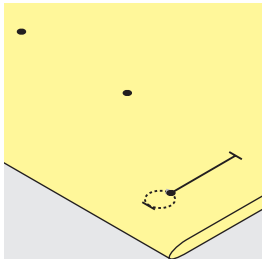
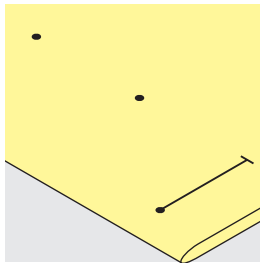
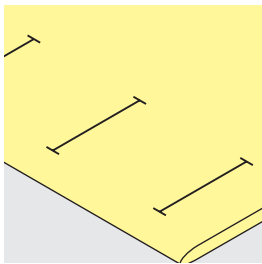

Marking the length of manual buttonholes

- mark the buttonhole length in the desired position
- use Buttonhole foot No. 3C (optional accessory)

Marking the length of automatic buttonholes

- mark the length of just one buttonhole
- ▶ after sewing the first buttonhole the length is programmed
- mark only the beginning of all subsequent buttonholes
- use automatic Buttonhole foot No. 3A

Marking the length of keyhole buttonholes

- mark the bead length only
- ▶ the correct eye length will be added when the buttonhole is sewn
- ▶ after sewing the first buttonhole the length is programmed
- mark only the beginning of all subsequent buttonholes
- use automatic Buttonhole foot No. 3A

Test sample

- always sew a test sample on the same fabric and stabilizer to be used for the project
- select the buttonhole type you intend to use
- sew the buttonhole in the same direction on the fabric (horizontal or vertical, with or against the grain)
- cut the buttonhole open
- insert the button through the buttonhole
- adjust the buttonhole length if necessary

Adjusting the bead width

- alter the stitch width

Altering the stitch length

Stitch length adjustments affect both buttonhole beads.

- ▶ spacing between the stitches

After stitch length adjustment:

- re-program the buttonhole



If a buttonhole is to be sewn at right angles to the seam, we recommend the use of the height compensation plates (optional accessory). Place the plates from the back between fabric and bottom of slide foot up to the thick part of the fabric and push to front.

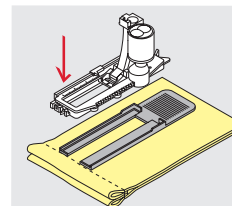

When sewing a buttonhole in difficult materials, we recommend using the Compensation plate for buttonholes (optional accessory). It can be used along with Buttonhole foot No. 3A.

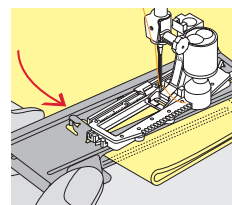

Stabilizer

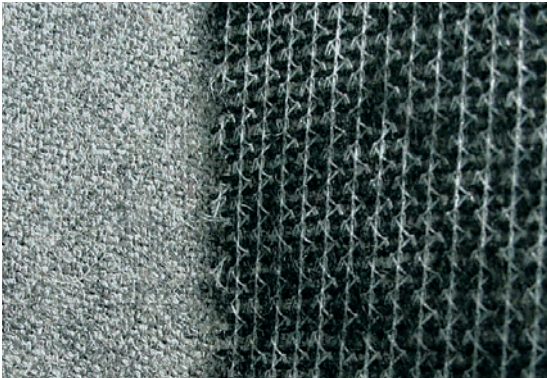

- interfacing provides durability and stability to the buttonhole
- choose the interfacing according to the material being used

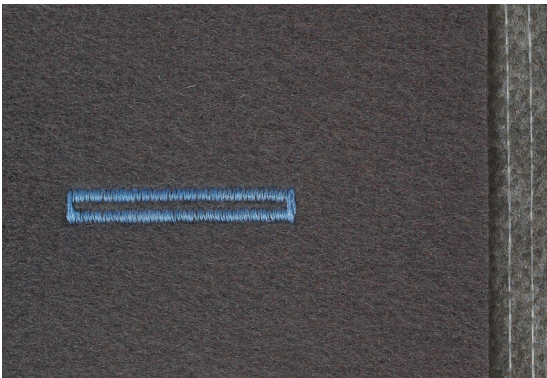

- when using thick or fluffy materials an embroidery stabilizer can be used
- ▶ therefore the fabric feeds better

Cord

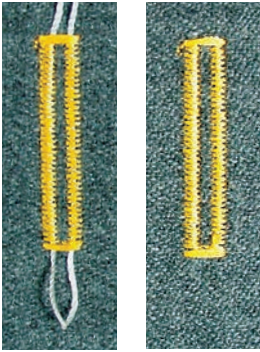

In general

- cords reinforce buttonholes and enhance their appearance
- mainly suitable for buttonhole No. 51
- position the work accordingly

Ideal cords

- Perle cotton No. 8
- strong hand-sewing thread
- fine crochet yarn

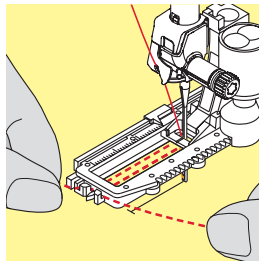
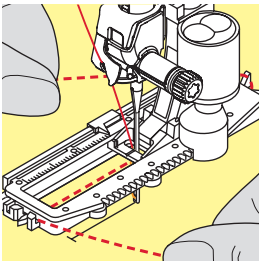

Cord with the automatic Buttonhole foot No. 3A

- raise the Buttonhole foot No. 3A
- insert the needle at the beginning of the buttonhole
- guide the cord on the right side under the Buttonhole foot No. 3A
- hook the cord over the pin at the back of the Buttonhole foot No. 3A
- pull the cord on the left side under the Buttonhole foot No. 3A to the front
- pull the cord ends into the slits
- lower the Buttonhole foot No. 3A

Sewing

- sew the buttonhole in the usual manner
- do **not** hold the cord
- the buttonhole will sew over the cord, covering it

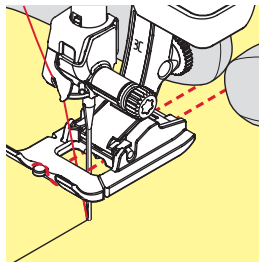
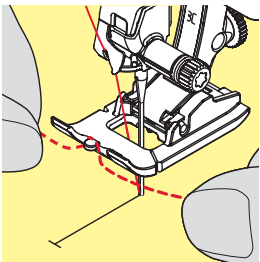

Cord with the Buttonhole foot No. 3C (optional accessory)

- raise the buttonhole foot
- insert the needle at the beginning of the buttonhole
- hook cord over the pin in the middle of the buttonhole foot (at the front)
- pull both cord ends under the buttonhole foot sole to the back and
- place both ends of the cord in the grooves on the sole
- lower the buttonhole foot

Sewing

- sew the buttonhole in the usual manner
- do **not** hold the cord
- the buttonhole will sew over the cord, covering it

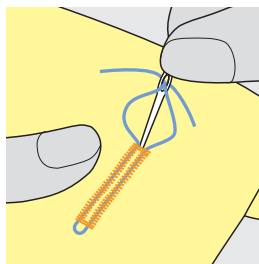

Fixing the cord

- pull the cord through the buttonhole until the loop disappears into the end of it
- pull the ends of the cord through to wrong side of the fabric, using a hand stitching-needle
- knot or secure with stitches



Before cutting the buttonhole open

Place a pin in each end of the buttonhole to avoid accidental cutting into ends of buttonhole.

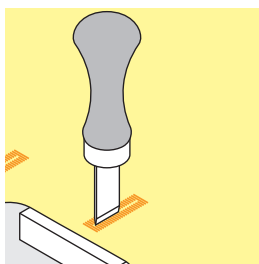
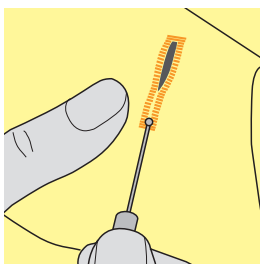

Cutting buttonholes open with the seam ripper

- cut the buttonhole from the ends to the middle

Cutting open buttonholes with the buttonhole cutter (optional accessory)

- place the fabric on the wood
- place the cutter in the center of the buttonhole
- press down on the cutter with your hand

Altering the balance



- touch the «i»-icon
- touch the «Balance»-icon

Balance with direct entry length buttonholes

The balance alterations have the same effect on both beads.

Balance with direct entry length keyhole or round buttonholes

The balance alterations have the same effect on both beads.

The keyhole or eye is balanced as follows:

- sew straight stitches forward until
- ▶ the sewing computer changes to the keyhole or eye, then
- stop the sewing computer
- touch the «Balance»-icon
- turn the stitch length-knob until the picture in the right portion of the Display is identical with the sewn buttonhole

The keyhole is distorted to the right **1**:

- turn the stitch length-knob to the left

The keyhole is distorted to the left **2**:

- turn the stitch length-knob to the right
- touch the «i»- or «Close»-icon and finish the buttonhole

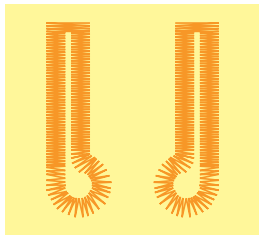

1

2

Balance for manual keyhole or round buttonhole

Any balance alteration affects both beads differently:

Left bead too dense **3**:

- turn the stitch length-knob to the left
- ▶ the left bead is elongated, the right bead is shortened



3

Left bead too wide **4**:

- turn the stitch length-knob to the right
- ▶ the left bead is shortened, the right bead is elongated



4

The keyhole or eye is balanced as follows:

The keyhole is distorted to the right **1**:

- turn the stitch length-knob to the right

The keyhole is distorted to the left **2**:

- turn the stitch length-knob to the left

Balance for manual standard buttonhole

The balance alterations have the same effect on both beads.

Balance for stitch counter buttonhole

The balance has a different effect on both beads (see picture of the manual buttonhole).

- re-program the buttonhole after each alteration in balance

Clear Balance

- touch the yellow-framed icon in the special Balance-Display or
- press «clr»-button
- ▶ «clr» also deletes the programmed buttonhole!

Recommendation

Test-sewing of the buttonhole on the original material.



In all direct entry length and manual buttonholes each individual buttonhole sequence can be balanced separately.
In stitch counter buttonholes the balance affects both beads differently (left and right): When altering the bead the keyhole or eye are automatically altered accordingly.

Programming buttonholes

Standard and stretch buttonhole with auto-length, automatically

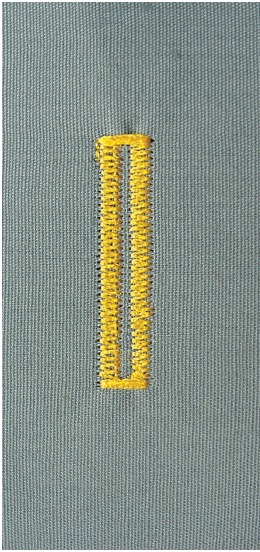

Buttonhole foot No. 3A

The lens on the automatic Buttonhole foot No. 3A automatically registers the length of the buttonhole for exact duplication. For buttonholes of 4-31 mm, depending on the buttonhole type.



The slide foot must lie perfectly flat on the fabric! If the slide foot rests on a seam allowance, the length cannot be measured accurately.

Automatic standard and stretch buttonhole No. 51, 52, 53

Programming buttonholes

- 1
 - sew first bead forward
 - stop the sewing computer
 - press «Quick reverse»-button
 - ▶ «auto» and the programmed length (in mm) appears in the Display
 - ▶ the buttonhole length is programmed

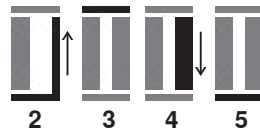

The sewing computer sews the following automatically:

- 2 the straight stitches in reverse
- 3 the first bartack
- 4 the second bead forwards
- 5 the second bartack and securing stitches
 - ▶ the sewing computer stops and returns automatically to buttonhole begin

Auto buttonhole

- ▶ all subsequent buttonholes will be sewn to exactly the same length (no need to press «Quick reverse»-button)
- the programmed buttonholes can be saved in the long-term memory (see page 105)
- press «clr»-button
- ▶ the programmed settings are cleared



Exact duplication

The auto function ensures that each buttonhole will be exactly the same length as the previous one.

Sewing speed

- sew at moderate speed for best results
- sew all buttonholes at the same speed for a consistent bead density

Automatic with Direct Entry Length

Buttonhole foot No. 3A

Programming the buttonhole length

Buttonholes can be sewn to a specific length with the Buttonhole foot No. 3A. Buttonhole length = cutting length in mm.



- select the desired buttonhole
- touch the «i»-icon
- touch the «Direct entry length»-icon

Determining the buttonhole length

- enter the buttonhole length using the multifunction knobs (stitch width or stitch length knob)
 - ▶ the length entered appears below the buttonhole
 - ▶ the number above the button is the exact button size
- touch small «i»-icon in the upper part of the Display
 - ▶ the Function Overview appears
 - ▶ the length entered is saved
 - ▶ «auto» and the programmed length is shown on the left side in the Display

Back to the Buttonhole menu

- touch the «i»- or «Close»-icon
- ▶ the buttonhole Display appears

Automatic with Button measuring

Buttonhole foot No. 3A

Determining button size

The sewing computer calculates the length of the buttonhole directly from the diameter of the button. 2 mm are automatically added for the button thickness.

- hold the button on the yellow circle in the right portion of the Display
- adjust the yellow circle to the size of the button using the stitch width or the stitch length knob
 - ▶ the button size is indicated above the button between the two lines (i.e. 14 mm)
- remove the button from the Display
- touch the «i»- or «Close»-icon
- ▶ the length entered is saved
- ▶ «auto» and the programmed length is shown on the left side in the Display

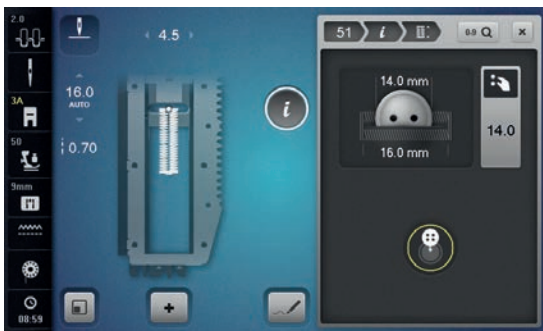

Corrections for thick buttons

Match buttonhole length to buttonhole thickness (raised buttons, etc.) e.g. buttonhole length + 1 cm (incl. 2 mm) if button height is 1 cm. The button slides easily through the buttonhole.



Back to buttonhole begin

- touch the «Pattern begin»-icon
- ▶ the sewing computer sets the program to the start of the buttonhole again



Deleting saved buttonholes

- press the «clr»-button or touch the «REC»-icon
- ▶ «auto» goes off and «REC» appears
- a new buttonhole length can be programmed

Automatic round and keyhole buttonhole



Buttonhole foot No. 3A



The slide foot must lie perfectly flat on the fabric! If the slide foot rests on a seam allowance, the length cannot be measured accurately.

Automatic Round and Keyhole buttonhole No. 54-58, 68

Programming buttonholes

- 1
 - sew straight stitches forward
 - stop the sewing computer
 - press «Quick reverse»-button
 - ▶ «auto» and the programmed length (in mm) appears in the Display
 - ▶ the buttonhole length is programmed



The sewing computer sews the following automatically:

- 2 the eye
- 3 the first bead in reverse
- 4 the straight stitches forward
- 5 the second bead in reverse
- 6 the bartack and securing stitches
 - ▶ the sewing computer stops and returns automatically to buttonhole begin

Auto buttonhole

- ▶ all subsequent buttonholes will be sewn to exactly the same length (no need to press the «Quick reverse»-button)
- the programmed buttonholes can be saved in the long-term memory (see page 105)
- press «clr»-button
- ▶ the programmed settings are cleared



Exact duplication

The auto function ensures that each buttonhole will be exactly the same length as the previous one.

Double sewn keyhole buttonholes

- keyhole buttonholes can be sewn twice on thick fabrics - use a longer stitch length for the first run
- after sewing the first buttonhole, do not move the work
- reduce the stitch length manually and sew the buttonhole again

Round buttonhole No. 64, buttonhole with double pointed bartack No. 66 and decorative buttonhole with double pointed bartack No. 69

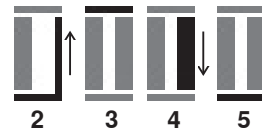

Programming the buttonhole

- 1
 - sew the first bead forward
 - stop the sewing computer
 - press «Quick reverse»-button
 - ▶ «auto» and the programmed length (in mm) appears in the Display
 - ▶ the buttonhole length is programmed

The sewing computer sews automatically:

- 2 straight stitches in reverse
- 3 the upper eye/pointed bartack/bartack
- 4 the second bead forward
- 5 the lower eye/pointed bartack/bartack and the securing stitches
 - ▶ the sewing computer stops and returns automatically to buttonhole begin

Auto buttonhole

- ▶ all subsequent buttonholes will be sewn to exactly the same length (no need to press «Quick reverse»-button)
- the programmed buttonholes can be saved in the long-term memory (see page 105)
- press the «clr»-button
- ▶ the programmed settings are cleared

Heirloom Buttonhole

Buttonhole foot No. 3A

Heirloom buttonhole No. 63, 65,
Round buttonhole with pointed bartack No. 67,
Knitware buttonhole No. 70

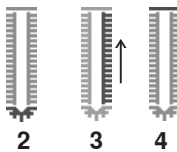
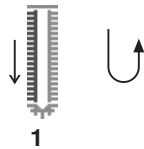

Programming buttonholes

- 1
 - sew first bead forward
 - stop the sewing computer
 - press «Quick reverse»-button
 - ▶ «auto» and the programmed length (in mm) appears in the Display
 - ▶ the buttonhole length is programmed

The sewing computer sews the following automatically:

- 2 the round part/bartack
- 3 the second bead in reverse
- 4 the bartack (No. 63, No. 67, No. 70), the upper eye (No. 65) and the securing stitches
 - ▶ the sewing computer stops and returns automatically to buttonhole begin

Auto buttonhole

- ▶ all subsequent buttonholes will be sewn to exactly the same length (no need to press «Quick reverse»-button)
- the programmed buttonholes can be saved in the long-term memory (see page 105)
- press «clr»-button
- ▶ the programmed settings are cleared

Stitch Counter Buttonhole



- touch the «i»-icon
- touch the «REC 123»-icon

Buttonhole foot No. 3C (optional accessory)

All buttonhole types

Programming buttonholes

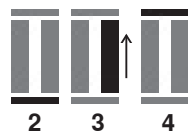

- 1
 - sew first bead forward
 - stop the sewing computer
 - press «Quick reverse»-button
- 2 sew lower bartack and
- 3 sew second bead in reverse
 - stop the sewing at the first stitch
 - press «Quick reverse»-button
- 4 the sewing computer sews the upper bartack, the securing stitches and stops automatically
 - ▶ «auto» appear in the Display
 - ▶ the buttonhole length is programmed
 - ▶ each subsequent buttonhole the programmed number of stitches are sewn



– the first bead (left) is sewn forwards, the second bead (right) is sewn in reverse

Buttonhole in Long Term Memory



- touch the «Memory»-button

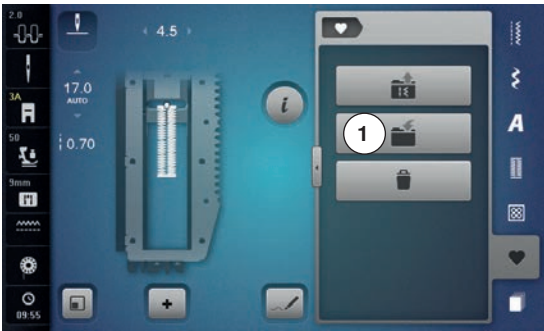

Programming the buttonhole

- touch the «Save»-icon 1
 - ▶ a Display with four folders appears
- select the folder where the buttonhole is to be saved, e.g. 1
- touch the yellow-framed «Save»-icon
 - ▶ the buttonhole is now saved in long term memory



- touch the «Memory»-button

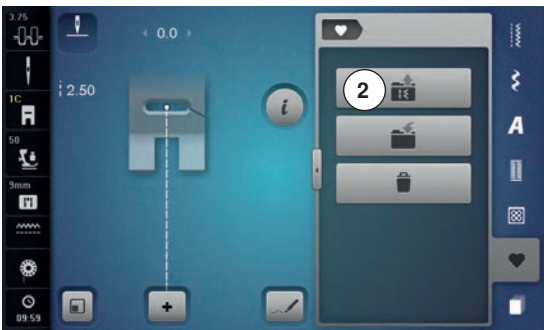

Selecting a saved buttonhole

- touch folder 2
 - ▶ a Display with four folders appears
- select the folder where the buttonhole is to be select, e.g. 1

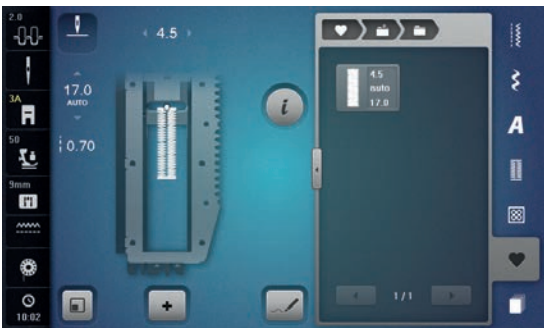

- select buttonhole

Buttonholes



Altering saved buttonhole

- touch the «i»-icon
- touch the «Direct entry length»-icon
- alter the length of the saved buttonhole
- touch the «i»- or «Close»-icon
- reprogram the buttonhole as described



- touch the «Memory»-button

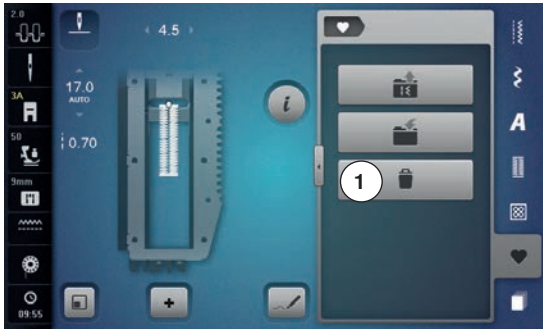

Deleting a saved buttonhole

- touch the «Delete»-icon **1**
- ▶ a Display with four folders appears
- ▶ select the folder where the buttonhole is to be deleted, e.g. 1
- touch ✓ to confirm
- ▶ the buttonhole is deleted

7- or 5-step Buttonhole, manually



Buttonhole foot No. 3C (optional accessory)

- select the desired buttonhole
- touch the «i»-icon
- touch the «man»-icon

The length of the beads is manually determined when sewing. Bartack, eye and securing stitches are pre-programmed. The individual steps can also be selected by scrolling, by using the arrow icons, by direct selection or by touching the «Quick reverse»-button.



Sewing 7-Step buttonhole

- ▶ step 1 is activated for buttonhole begin
- ▶ step 2 is activated when beginning to sew
- sew first bead
- stop the sewing computer at desired length of the bead or to the end of the length marking
- select step 3
- ▶ sewing computer sews straight stitches in reverse
- stop sewing computer at the height of the first stitch (buttonhole begin)
- select step 4
- ▶ the sewing computer sews top bartack and stops automatically
- select step 5
- ▶ the sewing computer sews the second bead
- stop the sewing computer at the height of the first bead
- select step 6
- ▶ the sewing computer sews bottom bartack and stops automatically
- select step 7
- ▶ sewing computer secures stitches and stops automatically



Sewing 5-Step buttonhole

- ▶ step 1 is activated for buttonhole begin
- ▶ step 2 is activated when beginning to sew
- sew first bead
- stop the sewing computer at desired length of the bead or to the end of the length marking
- select step 3
- ▶ the sewing computer sews the eye or the keyhole and stops automatically
- select step 4
- ▶ the sewing computer sews the second bead in reverse
- stop sewing computer at the height of the first stitch (buttonhole begin)
- select step 5
- ▶ sewing computer sews the top bartack and secures stitches automatically



Straight stitch buttonhole No. 59

- The same programming procedure as with the auto buttonhole program (see page 100)
- Buttonholes No. 59 with the straight stitch is recommended for soft, loosely woven fabrics and for buttonholes that will receive excessive wear. The straight stitch buttonholes also reinforce, vinyl and felt

Button sew-on program



- touch the «Buttonhole»-button
- touch the «Button sew-on program»-icon

Darning foot No. 9 (optional accessory)
Button sew-on foot No. 18

Button sew-on program No. 60

For buttons with 2 and 4 holes.

Sewing on Buttons

Buttons sewn on for decorative purposes only are stitched without a «thread shank». «Shank length» = distance between button and fabric; can be adjusted with Button sew-on foot No. 18.

Sewing on buttons with Darning foot No. 9 (optional accessory)

- select button sew-on program
- check distances between holes with the handwheel
- adjust stitch width if necessary
- hold the threads when starting to sew
- sew the first securing stitches into the left hole
- sew program
- ▶ sewing computer stops automatically when program is completed and is ready for the next button

Beginning and ending threads

The threads are secured and can be trimmed.

For increased stability

- pull on both bobbin threads until the ends of the upper threads are visible on the wrong side
- pull the threads out and knot the ends additionally
- trim the threads

Sewing on buttons with foot No. 18

- set the shank length with the screw on the foot
- select button sewing-on program and continue as with foot No. 9 (optional accessory)

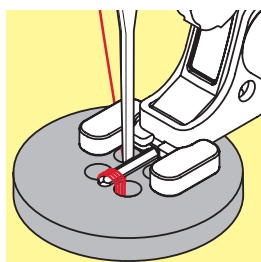
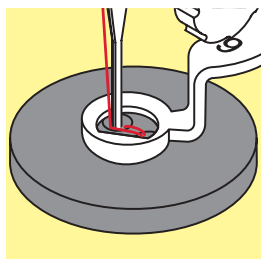
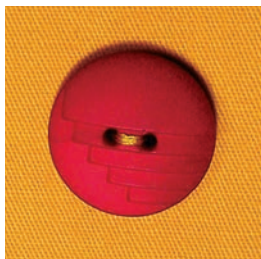

Sewing on a 4-hole button

- sew the front holes first
- carefully move the button forward
- sew the back holes with the same program



For a increased stability the button sew-on program can be sewn twice.

Eyelet Program



- touch the «Buttonhole»-button
- touch the «Eyelet program»-icon

Reverse pattern foot No. 1C
Open embroidery foot No. 20C

Eyelet with small zig-zag No. 61
Straight stitch eyelet No. 62



Sewing eyelets

- select eyelet
- position fabric under the presser foot and sew eyelet program
- ▶ the sewing computer stops automatically and is at the beginning of the eyelet program again

Punching eyelets

- use an awl, punch pliers or a hole punch to open the eyelet



Adjust the roundness of the eyelet if necessary with balance.
 For increased stability sew the eyelet twice.

Decorative Stitches

Overview Decorative Stitches

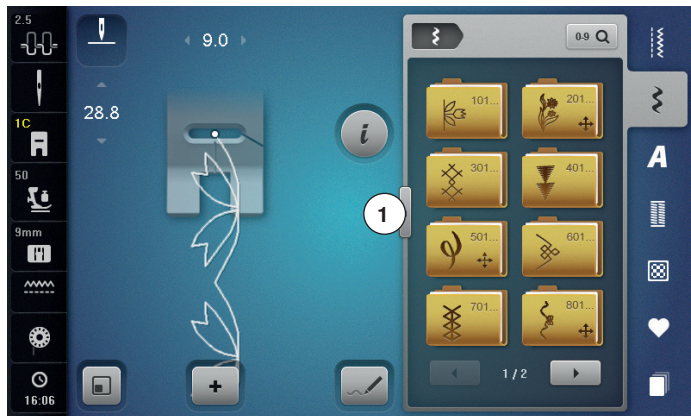

- press «Decorative stitch»-button
- ▶ Display shows an overview of the categories
- select the desired category
- ▶ the desired category is activated
- select desired stitch pattern



- touch icon 1
- ▶ the Display changes to the big overview
- touch icon 1 again
- ▶ the Display view is reset

Application

Depending on the type of material, simple or more complex decorative stitches should be selected to best suit the material.

- decorative stitches which are programmed with simple straight stitches, are particularly appropriate for light weight materials, e.g. decorative stitch No. 101
- decorative stitches which are programmed with triple straight stitches or with a few satin stitches are particularly appropriate for medium weight materials, e.g. decorative stitch No. 107
- decorative stitches which are programmed with satin stitches are particularly appropriate for medium weight materials, e.g. decorative stitch No. 401



Categories

- Cat. 100 = Florals
- Cat. 200 = Florals Sideways Motion
- Cat. 300 = Cross stitches
- Cat. 400 = Satin stitches
- Cat. 500 = Satin stitches Sideways Motion
- Cat. 600 = Ornamental stitches
- Cat. 700 = Heirloom stitches
- Cat. 800 = Heirloom stitches Sideways Motion
- Cat. 900 = Novelty
- Cat. 1000 = Novelty Sideways Motion
- Cat. 1100 = Tassel stitches
- Cat. 1200 = Filigree Stitches Sideways Motion
- Cat. 1400 = Tapering stitches
- Cat. 1500 = Skyline stitches
- Cat. 1700 = International



Perfect stitch formation

- use the same thread color for upper and lower thread
- reinforce the fabric on the wrong side using stabilizer
- use an additional, water-soluble stabilizer on the right side of pile or longfiber materials (e.g. wool, velvet etc.) which can be easily removed after sewing

Tapering

Tapering is a technique in which the stitch patterns come to a point at the beginning and end. Four different angles are pre-programmed and another angle can be determined manually.

No combinations can be created with tapering patterns.

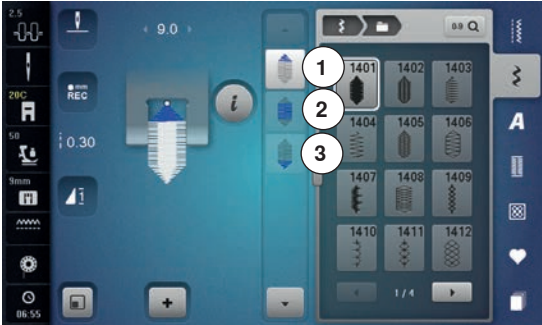

- select stitch No. 1401
- ▶ the first section 1 is active
- ▶ section 1 and 3 have a programmed length; you can set the length of section 2 yourself by pressing «Quick reverse»-button



Altering angle

- touch the «i»-icon
- touch the «Tapering»-icon

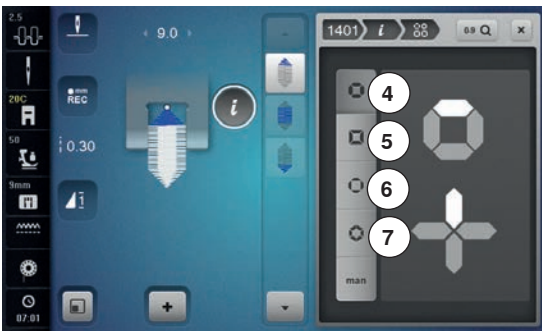

- ▶ the Display showing the overview of programmed angles appears
- ▶ angle 4 is active
- select another angle by touching the icons 5, 6 or 7



- touch the «man»-icon
- use the top «+» and «-» icons to move the tips of the pattern from -1.00 (far left) to 1.00 (far right)
- touch the yellow number in the center to place the tips in the center of the pattern (0.00)
- use the bottom «+» and «-» icons to set the angle of the tips between 0.00° and 90.00°
- touch the yellow number in the center to set the angle to 45°

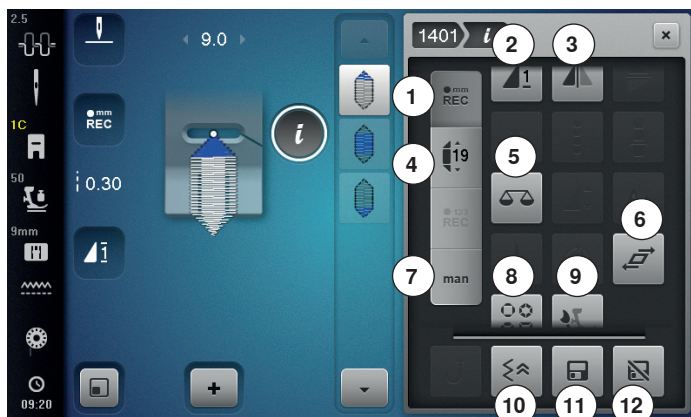

Tapering Functions

- touch the «i»-icon

- 1 Programming the length of section 2
- 2 Pattern repeat
- 3 Mirror Image left/right
- 4 Programming the length of section 2 by Entering mm
- 5 Balance
- 6 Distorting stitch patterns
- 7 Manual setting the Length of Section 2
- 8 Configuring the bead tapering
- 9 Balance BERNINA Dual Transport
- 10 Backstepping
- 11 Personal memory permanent
- 12 Reset



Programming the length of section 2

- ▶ «REC»-icon is active (dark), when a tapering pattern is selected
- sew the first section
- use «Quick reverse»-button to set the length of section 2
- ▶ once the length is programmed, the field is turned off (inactive, bright)
- ▶ after programming section 2, section 3 is sewn automatically and the sewing computer stops
- if a new length is to be programmed, touch the «REC»-icon again



Pattern repeat

Standard = 1 pattern

- ▶ the sewing computer stops at the end of an individual stitch or a stitch combination
- touch icon 2-9x
- ▶ numbers 2-9 appear
- ▶ the sewing computer stops after the programmed number of single rappers



Mirror Image left/right

The sewing computer sews the stitch pattern mirrored, left/right referring to the sewing direction.



Programming the length of section 2 by Entering mm

- touch the «Tapering length»-icon
- program the length using the stitch width or the stitch length knob
- touch the small «i» at the top of the Display
- ▶ the Function Overview appears
- sew the stitch pattern
- ▶ all three sections are automatically sewn and the sewing computer stops
- if a new length is to be programmed, touch the «REC»-icon again



Balance

To balance forward and reverse stitches.



Distorting the stitch pattern

- touch the upper «+» or «-» icon or turn the stitch width knob to the right or to the left
 - ▶ the stitch pattern will be distorted in 0.01 mm steps to the right or to the left
- touch the lower «+» or «-» icon or turn the stitch length knob to the right or to the left
 - ▶ the stitch pattern will be distorted in 0.01 mm steps forwards or backwards



Reset

- touch the icon
 - ▶ any alterations of the selected stitch pattern are reset to the original basic setting



Close

- touch the «i»- or «Close»-icon
 - ▶ the Display showing the functions is closed
 - ▶ the tapering patterns appear



Manual setting the Length of Section 2

- touch the «man»-icon
 - ▶ sew first section
- use «Quick reverse»-button to set the length of section 2
 - ▶ the third section is automatically sewn and the sewing computer stops
 - ▶ the length is not programmed and must be reset each time a new tapered pattern is started



Configuring the bead tapering

- touch the icon
 - ▶ an overview showing various tapering forms of beads appears



Balance BERNINA Dual Transport

Adjusting the feed of the upper fabric layer.



Backstepping

The last 200 needle penetrations of a stitch pattern are retraced, i.e. sewn backwards.



Personal memory permanent

- select a stitch pattern and alter e.g. stitch length or stitch width
 - touch the icon
 - ▶ the altered stitch pattern is saved

Stitch Designer

The stitch designer allows you to create your own stitch designs or to edit existing stitch patterns.



Stitch designer functions

- touch the «Stitch Designer»-icon
- ▶ «Edit»-Display appears

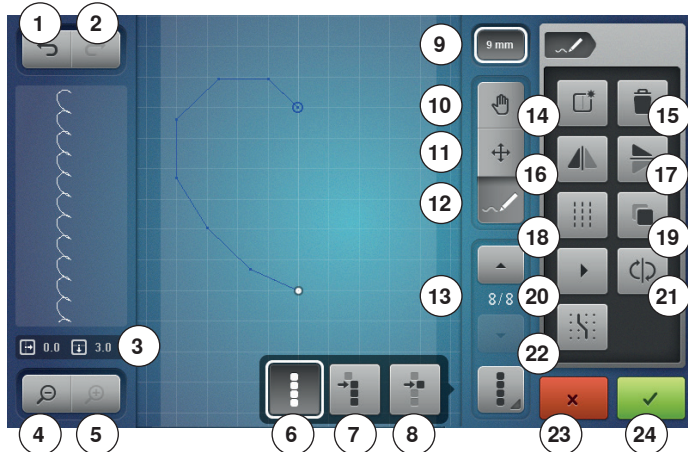

- 1 Undo
- 2 Redo
- 3 Absolute point position
- 4 Zoom minus
- 5 Zoom plus
- 6 Selecting all points
- 7 Selection from a defined point
- 8 Single point is selected/activated
- 9 Pattern width limitation
- 10 Moving the view of the stitch design
- 11 Moving points/Direct point selection
- 12 Inserting/editing a stitch
- 13 Scrolling through the points
- 14 Creating new stitch design
- 15 Deleting
- 16 Mirror Image left/right
- 17 Mirror Image up/down
- 18 Triple stitch
- 19 Duplicating
- 20 Slow re-draw
- 21 Reversing the stitch sequence
- 22 Snap to grid
- 23 Closing stitch designer
- 24 Confirming the entry



Undo

- touch the icon once or multiple times
- ▶ the entries are undone one by one



Redo

- ▶ as soon as the function «Undo» is touched, the icon «Redo» is activated
- touch the icon once or multiple times
- ▶ the entries are redone one by one



Absolute point position

The absolute point position is displayed:

- x axis: related to the centerline
- y axis: related to the last point



Zoom minus

- touch the icon once or more times
- ▶ the view of the stitch design is scaled-down in one step increments



Zoom plus

- touch the icon once or more times
- ▶ the view of the stitch design is enlarged in one step increments



Select all points

- touch the icon
- ▶ the complete stitch design is activated and can be edited with the selectable functions



Selection from a defined point

- touch the icon
- ▶ the stitch design can be edited from the activated point with the selectable functions



A single point is selected/activated

- A single point is active by default.
- ▶ the active point can be edited with the selectable functions



Pattern width limitation

- The function is activated by default = the design width is limited to 9 mm.
- touch the icon
 - ▶ wider designs, even sideway motion designs, can be created



Moving the view of the stitch design

- The view of the stitch design can be moved to any direction using the finger or the Touchscreen pen.



Moving points/Direct point selection

- touch the icon
- ▶ select the desired point or points
- ▶ the activated points of the stitch design can be moved using the stitch width or the stitch length knob, the finger or the Touchscreen pen



Inserting/editing a stitch

- The active point can be edited with the selectable functions or additional stitches can be inserted from that point.



Scrolling through the points

- Via the «up»/«down»-arrows the individual points of the stitch design can be scrolled through.



Creating new stitch design

- touch the icon
- ▶ an empty Display appears
- ▶ a new stitch design can be created



Deleting

- All active points of the stitch design are deleted.



Mirror Image left/right

- The active points of the stitch design are mirrored in lateral direction.



Mirror Image up/down

- The active points of the stitch design are mirrored lengthways.
A single point cannot be mirrored lengthways.



Triple stitch

- The activated stitches are sewn as triple stitches.



Duplicating

- All active points of the stitch design are duplicated.



Slow re-draw

- touch the icon
- ▶ the stitch design is re-drawn automatically in the new sequence of the stitch positioning.



Reversing the stitch sequence

- The stitch sequence of the active points of the stitch design are reversed.



Snap to grid

- touch the icon
- ▶ in place of the guides, screen dots are displayed
- ▶ each inserted point or the stitch sequence when free-style drawing is aligned with the nearest screen dot



Closing the stitch designer

- After having closed and reopened the stitch designer, the created/edited stitch pattern is deleted.



Confirming the entry

- touch the «OK»-icon
- ▶ the new created or edited stitch design is shown in the «Sewing»-Display and can be sewn

Creating or editing stitch design



Opening the Stitch Designer

- touch the «Stitch Designer»-icon

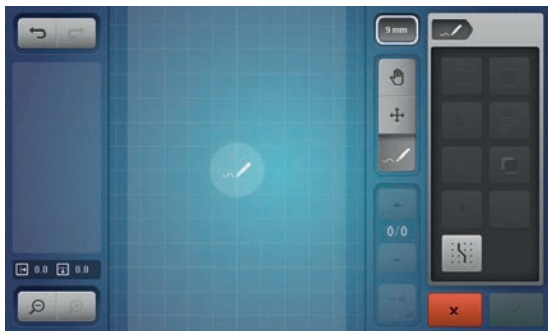

- ▶ the last active stitch pattern appears in the «Edit»-Display and can be edited
- touch the «Create new stitch design»-icon
- ▶ the «Edit»-Display is empty
- ▶ the guides are displayed, the spacing is 1 mm
- ▶ the function «Insert a stitch» is activated

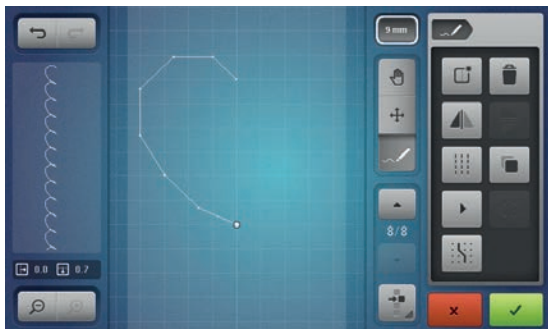

Creating a stitch design using the guides

- insert the first point in the «Edit»-Display using the finger or the Touchscreen pen
- insert the second point etc. and create the desired stitch design

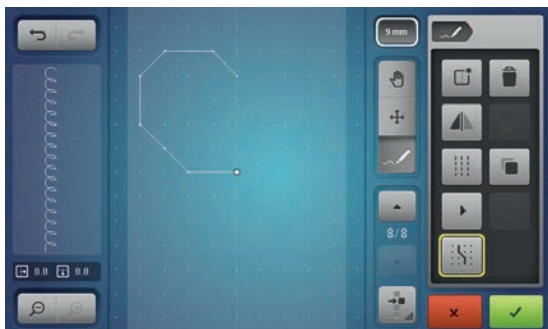

Creating stitch designs using screen dots

- touch the icon
- ▶ in place of the guides, screen dots are displayed
- ▶ the inserted point or stitch sequence when free-style drawing is aligned with the nearest screen dot automatically

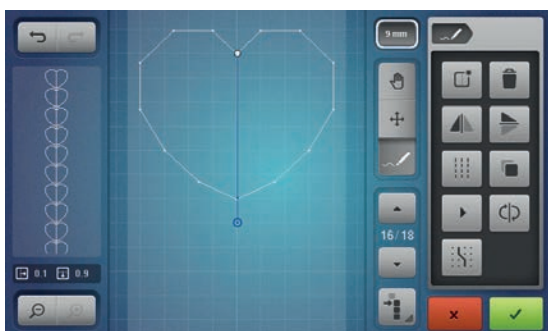

- if a stitch design ends with reverse stitches or is a closed shape, a forward stitch must be inserted on the same vertical axis as the first stitch so that the design can be sewn continuously
- ▶ in the preview window in the left display portion it can be seen whether or not a stitch design is sewn continuously

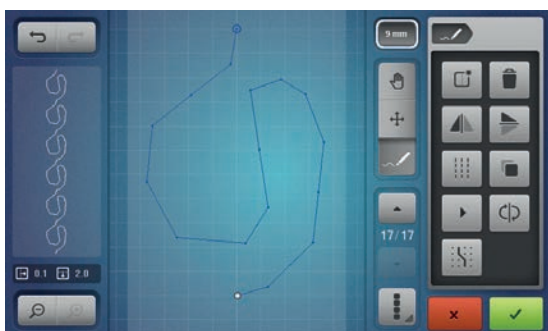

Free hand drawing

- using the finger or the Touchscreen pen, touch the «Edit»-Display and draw a stitch design
- ▶ if the distance between two dots is selected longer than 6 mm, the stitch is downsized to the maximally acceptable length

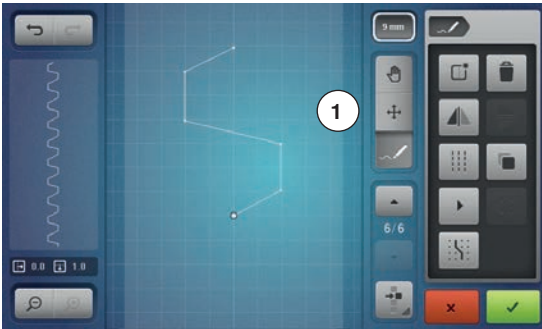

Selecting and moving a single point

- touch the function «Moving points» **1** and select the desired point or
- select the desired point via the «up»/«down»-arrows
- ▶ the point can be moved via the two knobs
- ▶ the function «Inserting stitch» is deactivated

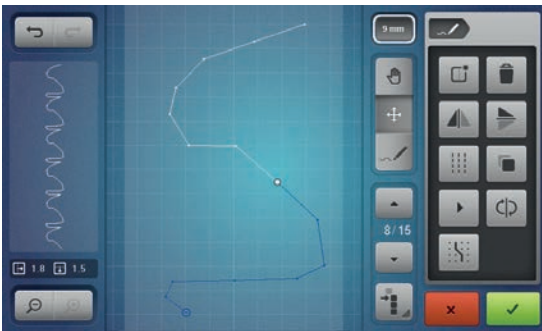

Moving several stitches

- touch the function «Selecting from a defined point»
- scroll through the points until the desired stitches are selected
- the marked stitch sequence can be moved via the knobs or, if the function «Moving points» is activated, also with the finger or the Touchscreen pen

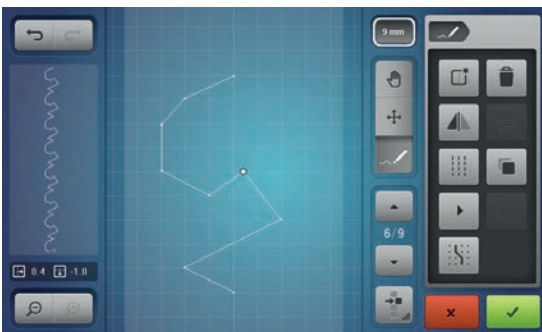

Inserting a point

A new point is inserted after a current position indicated by a white dot.

- select the desired point by scrolling
- touch the desired position in the Display with the finger or the Touchscreen pen
- ▶ the new point is inserted after the selected point and can be moved to the desired position with the knobs

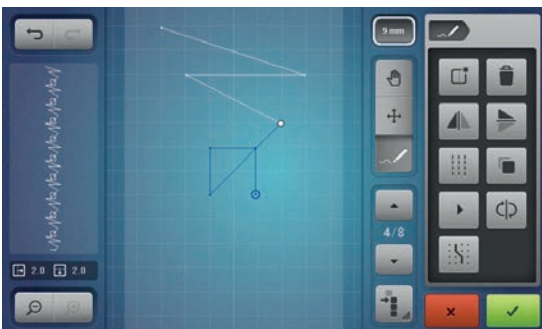

Duplicating

- to duplicate a stitch or a portion of the stitch design select the desired stitch sequence by touching the function «Select from a defined point» and using the up/down arrows to highlight the stitches
- touch the «Duplicate»-icon

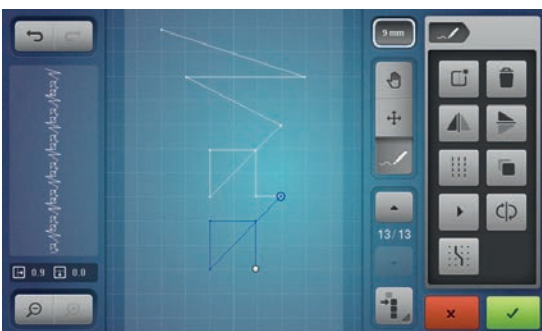

- ▶ the activated stitch or stitch sequence is duplicated
- ▶ the direction, the style and length of the activated part is transferred

Decorative Stitches

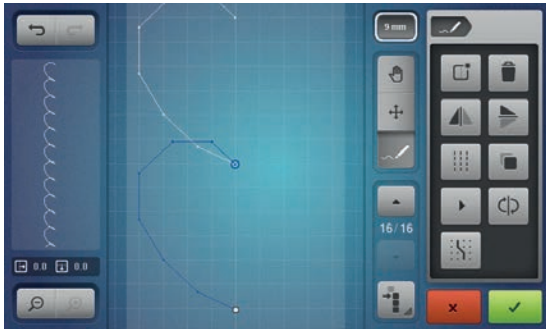

Reversing the stitch sequence

- create a stitch design
- touch the «Select all points»-icon
- touch the «Duplicate»-icon
- ▶ the stitch design is duplicated



- touch the «Mirror Image left/right»-icon
- ▶ the active stitch design is mirrored laterally

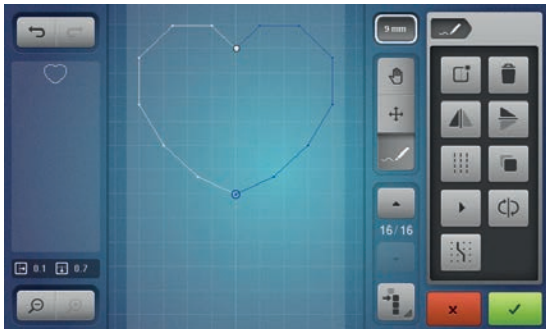

- touch the «Reverse stitch sequence»-icon
 - ▶ the stitch sequence of the active stitch design is reserved
- This is an easy and quick way to create new stitch designs.



Sewing stitch designs

- create a stitch design
- touch ✓ icon
- ▶ the «Edit»-Display closes
- ▶ the stitch design is displayed in the stitch pattern area and can be sewn

Stitch designs, which were created in the stitch designer, can be stored in the personal program, see on page 139.

Application examples of Decorative stitches

Cross Stitch

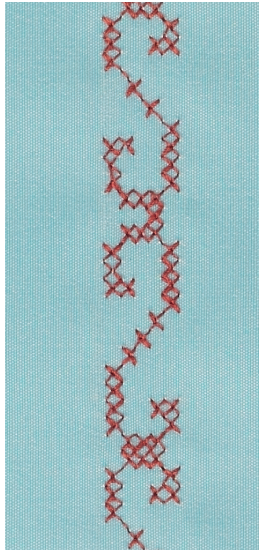
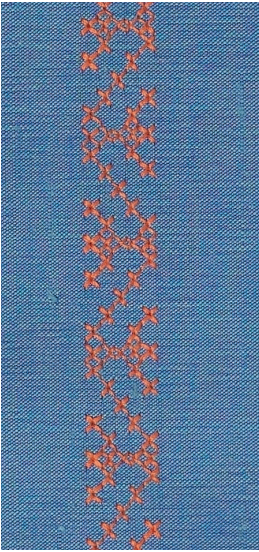

**Reverse pattern foot no. 1C/1D or
Open embroidery foot No. 20C or 20D (optional accessory)**

Cross Stitch

- cross stitching is a traditional technique, and extends the range of decorative stitches
- if the cross stitches are sewn on fabric with a linen texture, they look like hand-stitched cross stitching

Application

- for home furnishings
- for trimmings on garments
- for embellishing in general

Sewing

Cross stitches of Category 300 can be stitched and combined like any other decorative stitches.

Sewing Trims

- select cross stitch
 - stitch a row, using the seam guide or slide-on table seam guide
- It is important to stitch the first row in a straight line, as it will serve as a reference for the rows that follow.
- select new stitch pattern
 - stitch a second row next to first at a distance of one presser foot's width, or using the seam guide
 - repeat for the following rows of stitching



Use cotton embroidery thread for cross stitching
Stitch appears fuller.

Pintucks

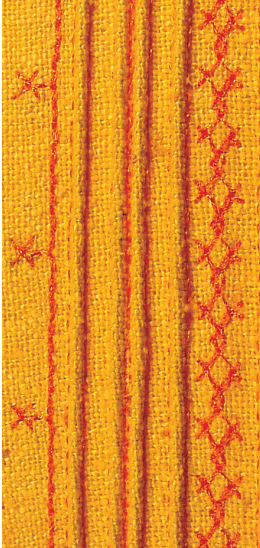

Sew delicate and decorative pintucks easily with the cording attachment. The tube on the attachment provides ample room for a cord to be inserted for sewing raised pintucks.

Pintuck feet (optional accessory)

- No. 30 (3 grooves) = 4 mm double needle: for heavy weight materials
- No. 31 (5 grooves) = 3 mm double needle: for heavy to medium weight materials
- No. 32 (7 grooves) = 2 mm double needle: for light to medium weight materials
- No. 33 (9 grooves) = 1 or 1.6 mm double needle: for very light materials (without additional pintuck cord)
- No. 46C (5 grooves) = 1.6-2.5 mm double needle: for very light to medium weight materials

Straight stitch No. 1

- pintucks are narrow stitched folds which are normally sewn on the fabric before cutting out the pieces for garments or other sewing projects
- this technique reduces the size of the fabric (allow for enough fabric)
- for embellishing or in combination with other heirloom embroidery techniques

Corded pintucks

- pintucks may be sewn with or without cord
- cord pintucks for a raised effect and texture
- chose a cord that fits well into the grooves of the selected pintuck foot
- the cord must be colorfast and shrinkproof

Attaching the cording attachment

Attach it simply by screwing it to the stitch plate with the screw provided.

- insert the positioning pin into the right thread hole and fasten the fixing screw in the left thread hole

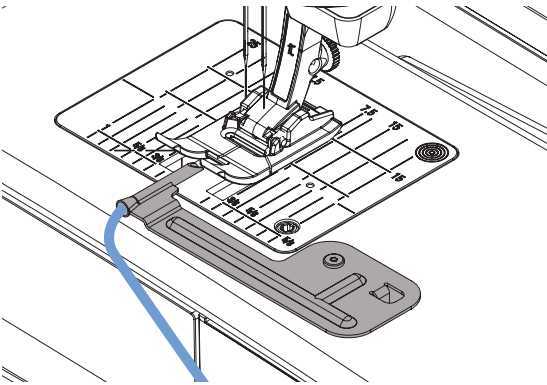

Inserting the cord

- attach the spool of the pintuck cord on the free hand system and lead the thread through the tube of the attachment

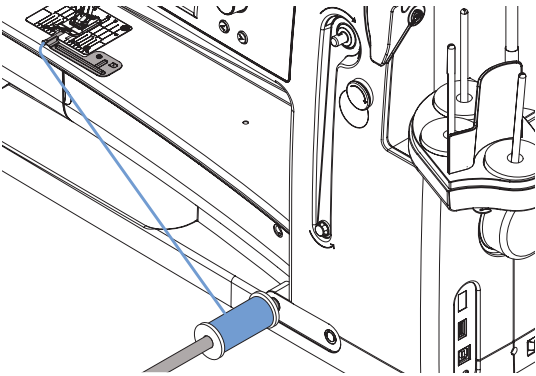

Sewing Pintucks

- sew first pintuck, marking the stitching line if necessary
 - ▶ the cord will automatically feed into the pintuck
- The cord lies on the wrong side of the material and is hold/sewn over by the lower thread.
- turn work if necessary
 - place first pintuck in one of the side grooves in the presser foot (depending on the desired distance)
 - sew second pintuck
 - sew additional pintucks parallel to these two

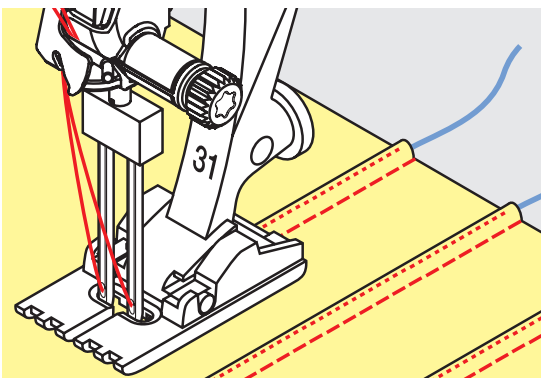

You can also use the cording attachment for a beautiful scallop off the edge finish on collars, cuffs and pintucks.

Bobbin-Play Sewing



Reduce the winding speed to wind decorative threads on the bobbin.



Free motion sewing

The bobbin can be filled different thread material. For free-motion stitching to add texture. This method is similar to «normal» free-motion sewing, but is done on the **wrong side** of the fabric.

Depending on thread thickness, use the tool contained in the accessories to loosen the lower-thread tension (see page **31**). Very thick thread must be wound onto the bobbin by hand (clockwise), then drawn through the hole in the hook with the threader (in accessories).

Reinforce the area to be sewn with embroidery stabilizer. The design can be drawn on the wrong side of the fabric. You can also draw the design on the front of the fabric, then follow the lines with a freely guided straight stitch and polyester, cotton or rayon thread. The rows of stitching are visible on the right side of the fabric, and serve as reference lines for the bobbin-thread sewing.

The BSR function can be used for bobbin-thread sewing. Guide your project at uniform speed evenly under the needle, follow the lines of the design. Remove the stabilizer after you finish sewing.

Sew a sample first to check what the result looks like on the wrong side of the fabric. If necessary, adjust the tension of the upper and lower thread.

Sewing decorative stitches

Not all decorative stitches are suitable for this technique. Simple decorative stitches provide best results. Avoid compact stitch types and satin stitches.

The Open Embroidery foot No. 20 or No. 20D (optional accessory) is ideal for this technique.

- adjust stitch length and width settings (widen, lengthen) so that nice results are also achieved when sewing with thicker threads
- using the long stitch function results in a less dense stitch pattern

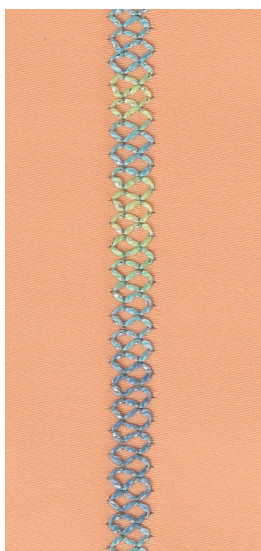

Quilt Stitches

Overview Quilt Stitches

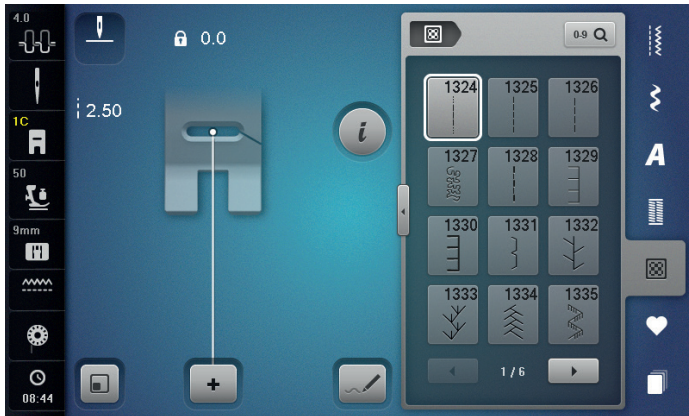

Various stitch patterns are available which are used especially in quilting, for patchwork or for appliqué.

- touch the «Quilt stitch»-button
- select desired stitch pattern
- ▶ the stitch width cannot be altered with certain stitch patterns
- ▶ is indicated by a lock symbol



1324 Quilters' securing program



1329 Blanket stitch



1339 Decorative quilt stitches variations
1339-1345, 1351, 1355-1371,
1373-1382, 1384-1391,
1393-1394, 1396-1398



1325 Quilting straight stitch



1330 Double blanket stitch



1347 Quilt stitch/Handlook quilt stitch variations
1347, 1348, 1350



1326 Piecing stitch/Straight stitch



1331 Blind stitch (narrow)



1352 Blanket stitch (dual)



1327 Stippling stitch



1332 Feather stitch



1353 Double blanket stitch (dual)



1328 Handlook quilt stitch



1333 Feather stitch variations
1333-1338



1354 Satin stitch

Application examples of Quilt stitches

Handlook quilt stitch

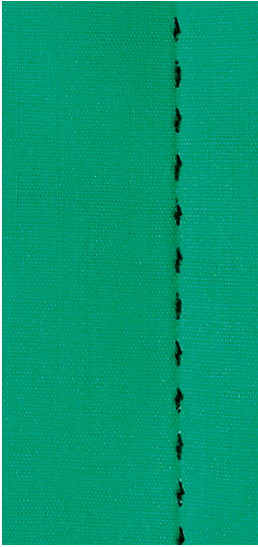

Reverse pattern foot No. 1C

Handlook quilt stitch No. 1328, 1347, 1348, 1350

Suitable for all fabrics and work which should look «hand sewn».

Thread

- Upper thread = Monofilament
- Lower thread = 30/2 cotton thread

Test sewing

- ▶ the lower thread is pulled up by tightened upper thread tension
- **one** stitch is visible (bobbin thread)
- **one** stitch invisible (monofilament) = hand-look effect

Upper thread tension

Depending on the fabric increase the tension (6-9).

Balance

Adjust stitch with the balance if necessary.



Monofilament breaks

- sew more slowly
- reduce upper thread tension slightly

Free-motion quilting

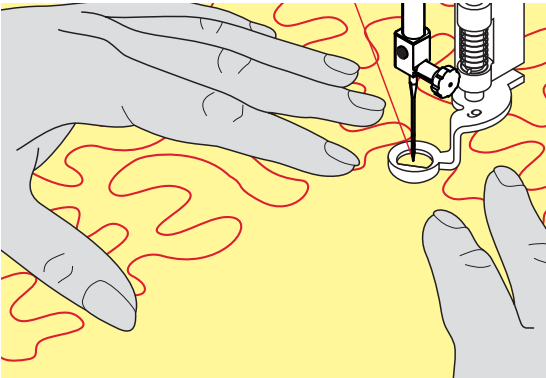
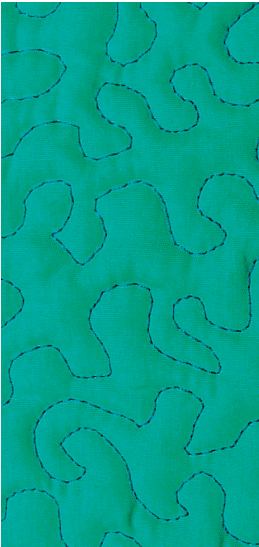

Darning foot No. 9 (optional accessory)

Straight stitch No. 1

Free-motion quilting

For all types of free motion quilting work.

Preparation

- pin top layer, batting and backing together, or baste if necessary
- attach slide-on table
- use the Free Hand System
- lower the feed dog

Holding the work

- hold the work with both hands like an embroidery frame, close to the presser foot



Quilt gloves with rubber fingertips will help when guiding the work.

Quilting a design

- quilt from the center outwards
- guide the work using smooth, round movements to form the design of your choice

Stipple quilting

- this technique covers the entire surface of the fabric with quilt stitches
- the lines of stitching are rounded and never cross one another



Free-motion quilting and darning

The two techniques are based on the same Free motion principles.

Poor stitch formation

- if thread is lying on top of the fabric, slow down the movement of the material
- if there are knots on the wrong side of the fabric, move the material more quickly

Monofilament breaks

Reduce the motor speed and/or loosen the upper thread tension.

Thread breaks

Guide the fabric more consistently.

BSR (BERNINA Stitch Regulator)

Quilting with BSR



BSR-Function

The BSR presser foot reacts to the movement of the fabric under the foot and controls the speed of the sewing computer up to the maximum speed possible. The following applies: the faster the fabric is moved, the higher the speed of the sewing computer.

If the fabric is moved too fast, an acoustic signal (beep sound) is heard, if the Beeper is activated (see page 129).

ATTENTION!

As long as the BSR presser foot is illuminated red, adjustments like threading and changing the needle, for example, must not be carried out, as the needle will engage while fabric is moved unintentionally! Without fabric feed the BSR mode is turned off after approx. 7 seconds and the red light goes off.

Please refer to Safety Instructions!

By activating the BSR function the sewing computer sews either continuously at reduced speed (mode 1, standard), or as soon as the fabric is moved (mode 2).

BSR function with straight stitch No. 1

This function using the BSR presser foot, allows for free-motion quilting (sewing) using the straight stitch and a pre-selected stitch length up to 4 mm. The regulated set stitch length is maintained within a certain speed, independent of the movement of the fabric.

BSR function with zig-zag No. 2

The zig-zag can be used e.g. for thread painting. The set stitch length will not be maintained when sewing with the zig-zag stitch, but the BSR function simplifies the application.

There are:

Two different BSR modes

- **BSR 1-Mode** is the active standard
- the sewing computer runs continuously at a reduced motor speed, as soon as the foot control or the «Start/Stop»-button is pressed
- the speed of the sewing computer is regulated by the movement of the fabric
- through continuous needle movement, securing in the same position is possible without pressing an additional button
- **BSR 2-Mode** is activated by selecting the «BSR 2»-icon in the «BSR»-Display
- the sewing computer will only engage if the foot control or the «Start/Stop»-button is pressed and the fabric is moved simultaneously
- the speed of the sewing computer is regulated by the movement of the fabric
- to secure press the «Securing function»-button
- by selecting the «BSR 1»-icon in the «BSR»-Display Mode 1 is activated



For an even sewing start (the first stitch) the foot control must be pressed and the fabric moved simultaneously. This also applies for sewing points and straight stitching within a round form.

If the BSR function is deactivated and later re-activated without the sewing computer being switched off in between, the last selected BSR mode is active.

When exceeding a certain speed, adhering to regular stitch length cannot be guaranteed.

Make sure that the lens on the bottom of the BSR foot is clean (no fingerprints, etc.). Clean lens periodically with soft, slightly damp cloth.

Preparation

- presser foot pressure may be reduced depending on the material type and thickness
- attach slide-on table
- use the Free Hand System

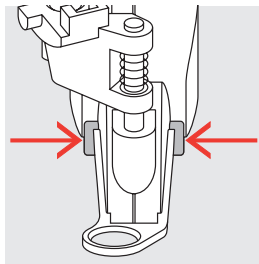

Remove presser foot sole

- press both buttons together
- slide the sole downwards out of the groove

Attaching the presser foot sole

- slide the desired sole up in the groove until it clicks into its place

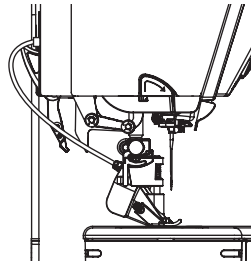
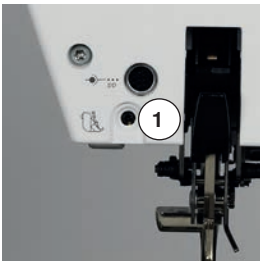

- attach the BSR Presser Foot to the sewing computer
- plug the cable in the outlet 1 provided

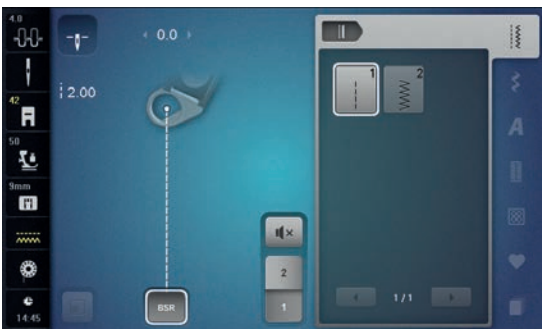

- ▶ «BSR»-Display is opened automatically
- ▶ BSR 1 mode is engaged
- set the desired stitch length
 - the standard stitch length is 2 mm
 - when sewing small forms and stippings, stitch length of 1-1.5 mm is suggested

Functions in the BSR mode

Needle stop down (standard)

- ▶ the arrow points down on «BSR»-Display
- ▶ the sewing computer stops with needle down, when taking foot off foot control or when «Start/Stop»-button is pressed

Needle stop up

- touch the «Needle stop»-icon in the Display
- ▶ the arrow points up
- ▶ the sewing computer stops with needle up, when taking foot off foot control or when «Start/Stop»-button is pressed

Raising or lowering the needle

- press «Needle stop»-button
- ▶ to raise or to lower the needle

Securing with «Start/Stop»-button (only Mode 1)

- place the fabric under the presser foot
- lower the presser foot
- press «Needle stop»-button twice
- ▶ the lower thread is brought up
- hold upper and lower thread
- press «Start/Stop»-button
- ▶ BSR mode starts
- sew 5-6 securing stitches
- press «Start/Stop»-button
- ▶ BSR mode is stopped
- cut threads
- press «Start/Stop»-button
- ▶ BSR mode starts
- continue the stitching process

Securing function (only Mode 2)

- press «Securing function»-button
- press either the foot control or «Start/Stop»-button

By moving the fabric short securing stitches are sewn, then the set stitch length will be activated and the securing function will be automatically deactivated.

Free motion quilting (only Mode 2)

- ▶ BSR mode is activated
- freemotion quilting can be sewn
- by touching the securing function button is pressed during free hand quilting, a short securing stitch sequence is sewn and
- ▶ the sewing computer stops
- ▶ BSR mode is deactivated

Free motion quilting without BSR activation

- touch the «BSR»-icon
- BSR mode is deactivated

Normal freemotion quilting can now be sewn with the BSR foot, without automatic regular stitch length.



Beeper (audio signal) activation/deactivation

- press «Setup»-button
- touch the «Acoustic signal»-icon



Selecting sound for BSR in the Setup Program

- ▶ one sound is set as default (active)
- touch the icon 1 showing the loudspeaker for BSR
- ▶ the loudspeaker turns white and the icon dark
- ▶ the sound for the beeper is inactive

The loudspeaker is dark and the icon is bright when the sound of the beeper is activated.

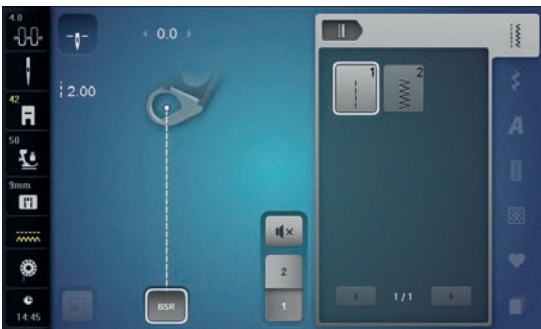

Selecting sound for BSR in the «BSR»-Display

- touch the icon with the loudspeaker
- ▶ the icon turns dark and the loudspeaker white
- ▶ the sound for the beeper is inactive

The icon with the loudspeaker is bright and the loudspeaker is dark when the sound for the Beeper is active.

Activating BSR Sewing Function

1st Option:

BSR-Function via the foot control.

- plug in the foot control
- press the foot control
- ▶ presser foot is lowered
- press the foot control again
- ▶ BSR mode starts
- ▶ a red light appears on the presser foot
- press foot control while sewing
- the speed of the sewing computer is regulated by the movement of the fabric
- release the foot control
- ▶ BSR mode is stopped

2nd Option:

BSR-Function via «Start/Stop»-button.

- press «Start/Stop»-button
- ▶ presser foot is lowered
- press «Start/Stop»-button again
- ▶ BSR mode starts
- ▶ a red light appears on the presser foot
- the speed of the sewing computer is regulated by the movement of the fabric
- press «Start/Stop»-button again
- ▶ BSR mode is stopped

Deactivating BSR Sewing Function by using «Start/Stop»-button

Mode 1

If the fabric is not moved for approx. 7 seconds, the BSR mode is deactivated and the red light on the presser foot goes off.

Mode 2

If the stitching process is ended by no longer moving the fabric, **one** additional stitch is made, depending on the needle position. The sewing computer always stops with needle up, even if the arrow on the «BSR»-Display points down.



Holding the work

- hold the work with both hands like an embroidery frame, close to the presser foot
- abrupt movements (slowing down resp. speeding up) can result in slightly too short or too long stitches
- continuous movement (no abrupt movements) will provide best results
- do not pivot the fabric while sewing



Quilt gloves with rubber fingertips will help when guiding the work.



Application example:

- BSR with zig-zag No. 2
- zig-zag can be used for thread painting
- areas can be filled and therefore forms or pictures can be created

BSR Function deactivation

- pull out the plug of the BSR presser foot connection cable on the sewing computer
- remove the BSR foot

BERNINA Dual Feed

ATTENTION!

Only use «D» presser feet with cut-out at the center back.
If an incorrect presser foot is attached, the sewing computer will not start with the dual feed engaged. An error message will appear.

With the BERNINA Dual Feed the top and bottom layer of fabric are fed simultaneously. Striped and checkered patterns can be matched perfectly by even feeding.

Presser Feet Selection

- Reverse pattern foot No. 1D
- Zipper foot No. 4D



More «D» presser feet are listed in the enclosed accessories catalogue.

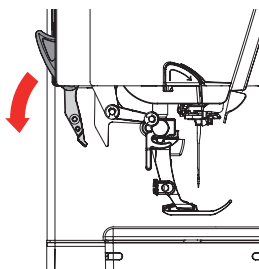

Switching on BERNINA Dual Feed

- raise the presser foot
- pull dual feed down until it engages

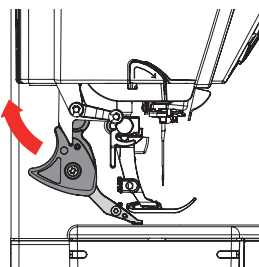

Switching off BERNINA Dual Feed

- raise the presser foot
- hold dual feed on holder with two fingers, pull it down
- then push backward, slowly letting it slide upward

Fabrics

Difficult-to-work-with fabrics (with a nap, slippery, sticky etc.):

- velvet, normally sewn with the grain
 - toweling
 - Jersey, especially when sewing it crosswise to knit
 - fake fur or coated fake fur
 - fleece-types of fabrics
 - batted fabrics
 - stripes and checks
 - curtain fabrics with pattern repeats
- «Sticky» Fabrics:
- imitation leather, coated fabrics (Dual Feed presser foot with sliding sole)

Application

Sewing:

- all sewing techniques on difficult fabrics, e.g. hems, zippers

Patchwork:

- accurate stripes and blocks
- decorative stitches up to 9 mm stitch width

Appliqué:

- open Embroidery foot No. 20D (optional accessory)
- sewing on ribbons and bias-binding



Presser foot pressure

Adjust the presser foot pressure to the fabric. The thicker the fabric the lower the presser foot pressure.

Alphabets

Overview Alphabets

Block, Double Block, Script and Comic Sans alphabets as well as Quilting Text, Cyrillic and Cyrillic script can be sewn in two different sizes.

Monograms can be sewn in three different sizes.

Block, Double Block, Script and Comic alphabets as well as Quilting Text, Cyrillic and Cyrillic script can also be sewn in lower case letters.

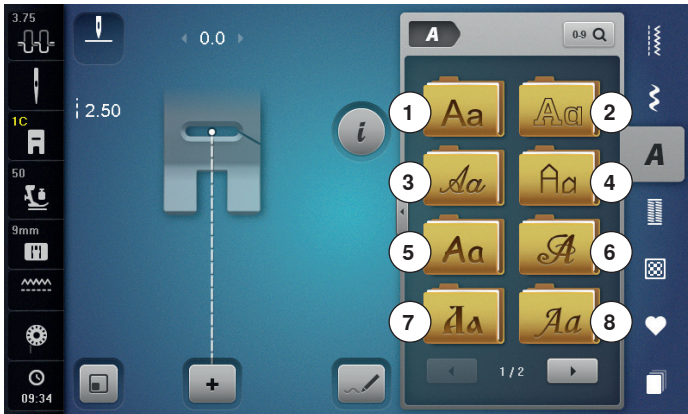

- touch the «Alphabet»-button
- ▶ the Display shows the overview with the different alphabet types
- 1 Block alphabet
- 2 Double-Block
- 3 Script (Italics)
- 4 Quilting Text
- 5 Comic Sans
- 6 Monograms 30/20/15 mm
- 7 Cyrillic
- 8 Cyrillic Script
- 9 Hiragana
- 10 Katakana
- 11 Kanji
- select desired alphabet



Lettering

- all capital letters, lower case letters, numbers, punctuation marks and special characters can be viewed using the arrow icons

Perfect stitch formation

- use the same thread color for upper and lower threads
- reinforce the fabric with embroidery stabilizer on the wrong side
- use an additional, water-soluble stabilizer on the right side of pile or napped fabrics (e.g. wool, velvet etc.)
- for lightweight fabrics more simple lettering types programmed with straight stitches are suitable (such as double block letters)

Combining characters

Individual letters and rows of the same letter of the same alphabet are sewn in single mode.

Letters for names, addresses, words, etc. are combined and sewn in combi mode.

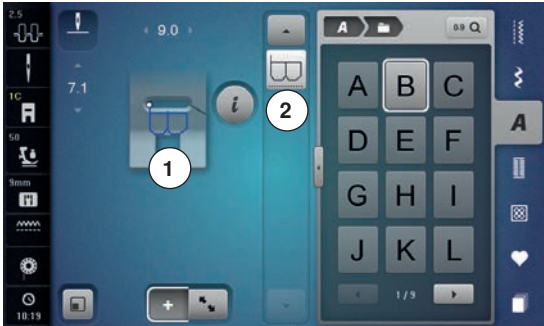

- touch the «Combi mode»-icon
- touch the icon with the desired letter
- ▶ the letter appears in the Stitch Altering Area 1 and in the Editing Area 2
- ▶ the cursor is below the letter



Selecting the next letter

- touch the required icon
- ▶ the next letter appears in the Stitch Altering Area and in the Editing Area



Large view of the Display

- touch icon 3
- select desired alphabet
- ▶ the Display showing the keyboard is opened
- ▶ the «ABC»-icon (upper case) is active automatically
- select desired lettering
- by scrolling at the bottom on the right in the Display more lettering can be viewed
- ▶ letters appear in the text bar 4



Corrections

- touch the «Delete»-icon
- ▶ the entered text is deleted from right to left

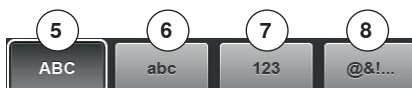

- 5 «ABC» upper case (Standard)
- 6 «abc» lower case
- 7 «123» numbers
- 8 «@?!» special characters

Correcting the combination



Inserting character

The letter is inserted below the cursor.

Activating desired place:

- select or scroll to required letter in the Editing Area
- ▶ the stitch pattern combination is moved to the starting position of the desired stitch pattern in the stitch altering area
- ▶ the starting point is indicated by a white dot **1** in the stitch hole of the virtual presser foot
- select new letter
- ▶ the letter is inserted after the selected letter



Inserting an additional letter at the beginning of a pattern combination:

- move the cursor to the top by using the arrow icons

Deleting Letters

A letter is deleted above the cursor.

Activating desired place:

- select or scroll to required letter in the Editing Area
- touch the «i»-icon
- touch the «Delete»-icon or
- select the desired letter with the finger, keep it pressed and move it to the right
- remove the finger from the Display
- ▶ letter is deleted

Saving and deleting combinations see page **143, 149**.

Alphabet in combination with functions

Selecting lower case letters

- scroll through the alphabet using the scrolling icons until the lower case letters appear
- touch the «abc»-icon in the large view of the alphabet, see page **135**



Altering font size

- touch the «i»-icon
- touch the «Font size»-icon
- ▶ the small «A» turns dark and the icon is yellow-framed
- ▶ the letter is reduced
- touch the «Font size»-icon again
- ▶ the big lettering is active again (big «A» is dark)

Monograms



Monograms are stitched in sideways motion.

- ▶ start (white dot) and end (red cross) are visible in the Stitch Altering Area
- ▶ the stitch width cannot be altered
- ▶ is displayed by a symbol



- touch the «Fit to screen»-icon



- ▶ the stitch pattern is adjusted in the size and placed so that the whole stitch pattern is visible
- ▶ the virtual presser foot disappears



Monogram Sizes

Font size 1 = 30 mm

- ▶ when starting the monogram category the size is 1 is activated (big «A» is dark)
- ▶ monograms in size 1 are individual letters
- ▶ the sewing computer sews and stops automatically

Font size 2 = 20 mm

- touch the «Font size»-icon
- ▶ the «A» in the middle turns dark
- ▶ monograms in size 2 are individual letters
- ▶ the sewing computer sews and stops automatically

Font size 3 = 15 mm

- touch the «Font size»-icon
- ▶ the small «A» turns dark
- ▶ monograms in size 3 are individual letters
- ▶ the sewing computer sews and stops automatically



Sideways-Motion stitch patterns, e.g. Sewing Monograms

- use the slide-on table to increase your sewing surface
- when sewing Sideways Motion stitches make sure that the fabric is fed evenly and lightly, ensuring that it cannot push against or catch on anything
- it is important to let the sewing computer sew without pulling, pushing or holding the fabric back
- use the presser foot No. 40C

Sewing a test sample with the threads, the actual fabric and stabilizer you intend to use is recommended.



Balance

- stitch patterns may differ from the original shape depending on the fabric, stabilizer and thread quality
- with the Balance function it is possible to adjust the stitch pattern to suit the fabric used

Personal Program

Creating a personal Display

Use the Personal Program to create a folder with stitches you use the most for a special project. Stitch patterns as well as their alterations are saved in the Personal Program.



The following alterations can be saved:

- Stitch width
- Stitch length
- Needle position
- Thread tension
- Mirror Images
- Pattern extend
- Long stitch
- Balance
- Pattern repeat 1–9x

If the memory has already been filled with embroidery motifs and stitch pattern combinations, no further stitch patterns can be saved in the Personal Program. A message appears. The content in the memory must first be deleted to ensure there is sufficient free capacity.

Preparing stitch patterns



Programming/Saving first stitch pattern

- select e.g. the zig-zag in the «Practical stitch»-Display
- make alterations

- 1 • touch the «Personal program»-button 1



- touch the «Save»-icon 2



- ▶ a Display with four folders appears
- select the folder where the stitch pattern is to be saved, e.g. 1
- ▶ each folder can accommodate 100 stitch patterns in maximum or
- insert the USB stick
- touch the «USB stick»-icon 3
- ▶ the stitch pattern can be stored on the stick

Personal Program

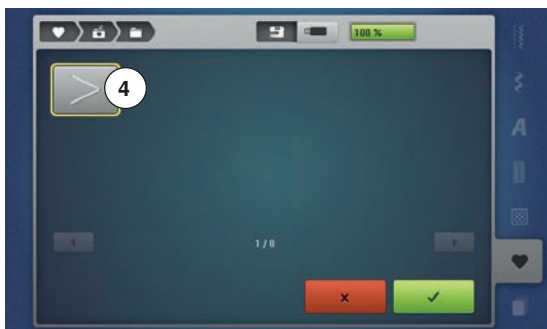

- touch the «Save»-icon 4 or ✓
- ▶ the altered zig-zag is saved
- ▶ the Display closes

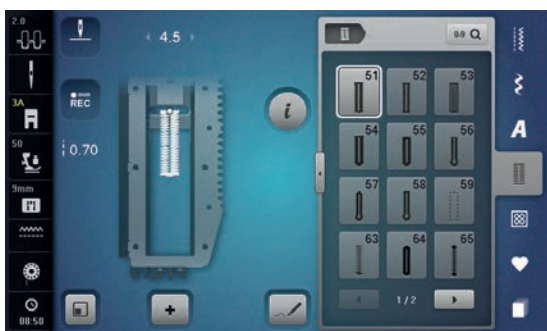

Programming/Saving second stitch pattern

- touch the «Buttonhole»-button
- select standard buttonhole No. 51
- save the stitch pattern as described above
- save any other stitch pattern in the same way



Stitch pattern selection in the Personal program

- touch the «Personal program»-button

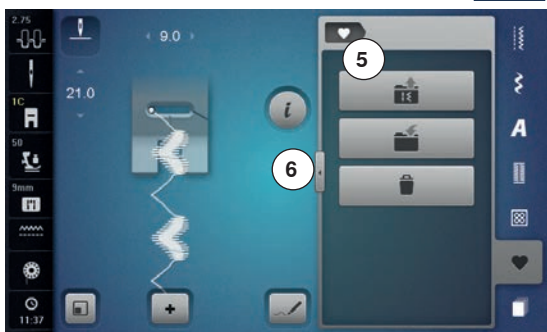

- touch the «Open»-icon 5
- touch desired folder e.g. 1 or
- touch icon 6

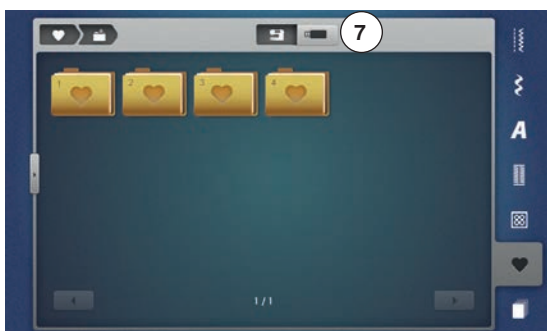

- insert the USB stick
- touch the «USB Stick»-icon 7
- ▶ saved stitch patterns can be selected



Personal Display

- ▶ the programmed stitch patterns are displayed in pictures plus stitch width and stitch length
- further stitch patterns can be scrolled by using the arrow icons

Altering/Overwriting stitch patterns

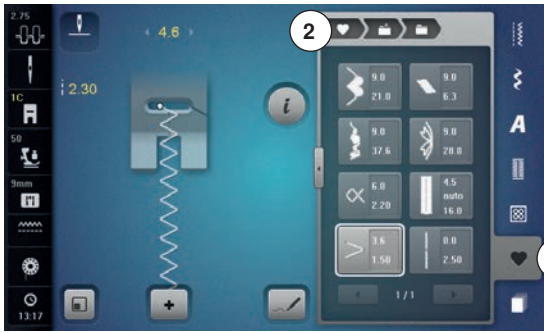

Selecting stitch patterns

- press «Personal program»-button 1
- touch the «Open»-icon
- touch desired folder
- select zig-zag
- make alterations
- ▶ stitch width and stitch length are altered (yellow numbers)
- touch the «Back»-icon 2
- touch the «Save»-icon
- select the same folder



- select zig-zag 3



- touch ✓ to confirm
- ▶ the alterations are saved

Personal Program

Deleting stitch patterns



Selecting stitch patterns

- touch the «Personal program»-button
- touch the «Delete»-icon 1
- select the desired folder or
- insert the USB stick
- touch the «USB stick»-icon



- select the stitch pattern to be deleted

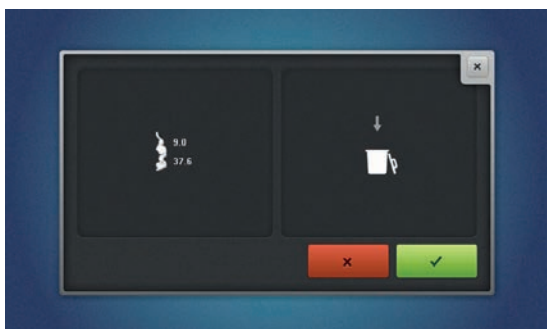

- touch ✓ to confirm
- ▶ stitch pattern is deleted
- ▶ the remaining stitch patterns are moved by one position

Combi Mode

The sewing-/embroidery computer has a memory system where both, the sewing and embroidery memories are saved.

In the sewing memory stitch patterns, lettering and numbers can be combined and saved.

In the sewing memory each «Drawer» can store a maximum of 70 stitch patterns as long as there is sufficient free space (capacity) available. If the storage space (but not all drawers) is full, there may be too many embroidery designs in the memory.

The memory is long-term, i.e. contents are kept until they are deleted. A power cut or switching off the sewing computer does not have any effect on the stored contents.

Creating Stitch pattern combinations



Programming and saving

- touch the «Decorative stitch»-button
- select category
- touch the «Combi mode»-icon
- select the desired stitch pattern directly or type in the number
- make any alteration concerning stitch length, stitch width, needle position etc.
- select another stitch pattern



- touch the «Personal program/Memory»-icon 1

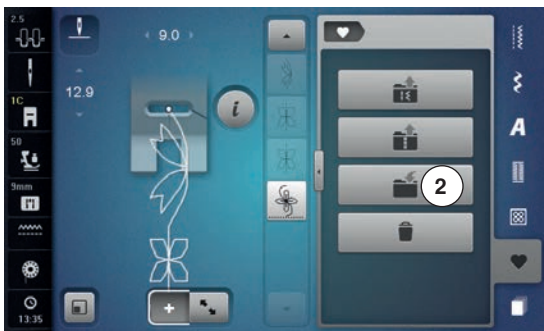

- touch the «Save»-icon 2



- touch the «Save»-icon 3 or ✓
- ▶ the combination is saved
- ▶ the Display closes

Deleting Stitch patterns

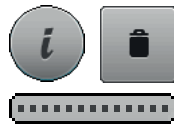

Deleting individual stitches

- touch the «i»-icon
- touch the «Delete»-icon
- ▶ the stitch pattern above the cursor is deleted
- touch the «Delete»-icon as many times until the Stitch Altering Area is empty or
- select the desired stitch pattern with finger, keep it pressed and move it to the right
- remove finger from the Display
- ▶ the stitch pattern is deleted
- repeat the procedure until the Stitch Altering Area is empty



Deleting entire combination

- touch the «i»-icon
- touch the «Edit whole combination»-icon
- touch the «Delete»-icon
- touch ✓ to confirm
- ▶ the Stitch Altering Area is empty
- touch the «Close»- or «i»-icon
- a new pattern combination can be programmed

Overview Combination

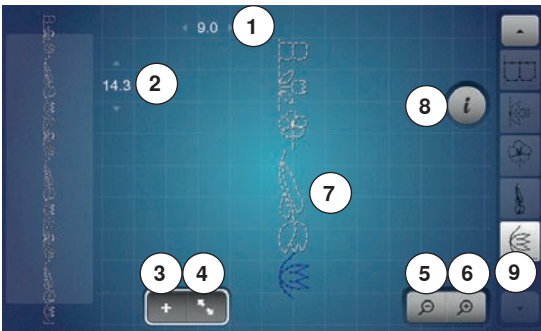

- touch the «Combination overview»-icon
- ▶ the Display shows following:

- 1 Stitch width of the active stitch pattern
- 2 Stitch length of the active stitch pattern
- 3 «Combi mode»-icon
- 4 «Combination overview»-icon
- 5 Reducing the combination view
- 6 Enlarging the combination view
- 7 Complete stitch combination
- 8 «i»-icon to show the functions in this Display
- 9 Stitch pattern combination can be scrolled via the arrow icons

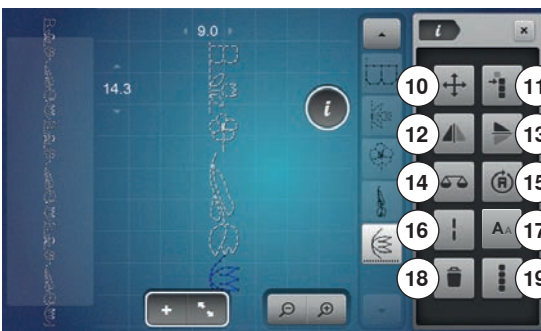

- touch the «i»-icon
 - ▶ following functions can be used:
- 10 Connecting stitches
 - 11 Moving single pattern or parts of a combination
 - 12 Mirror Image left/right
 - 13 Mirror Image up/down
 - 14 Balance
 - 15 Multi-Directional sewing
 - 16 Long stitch
 - 17 Font size in alphabets
 - 18 Deleting single pattern or parts of a combination
 - 19 Editing the whole combination
- ▶ each stitch pattern can be directly selected e.g. for alterations
 - touch the «Combination overview»-icon
 - ▶ the Display closes

Opening a saved combination



- touch the «Combination overview»-icon
- touch the «Memory»-button
- touch the «Open»-icon 1

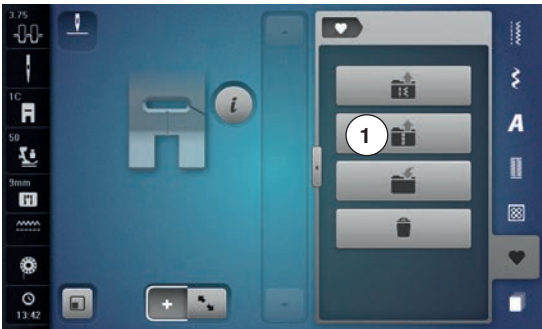

- ▶ a summary of the saved combinations appears
- touch the desired drawer
- ▶ the saved combination appears in the Stitch Altering Area



Correcting a stitch pattern combination

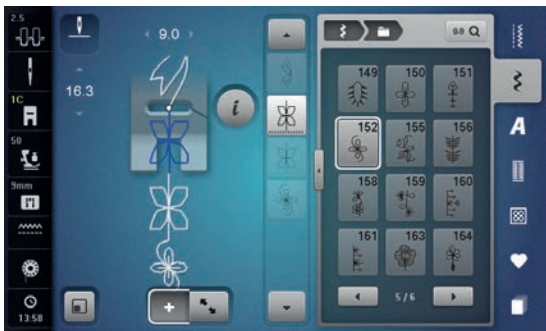

Inserting a stitch pattern

- select the desired position in the combination or in the Editing Area
- select a new stitch pattern
- ▶ the new stitch pattern is inserted below the selected stitch pattern

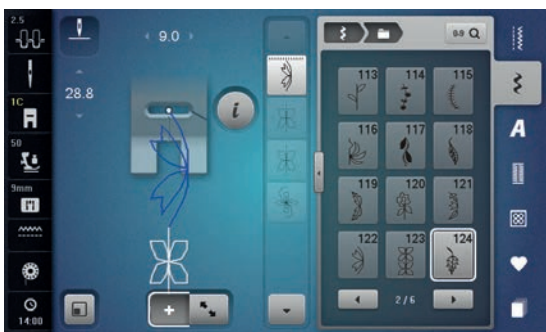

To insert a stitch pattern at the beginning of a combination the cursor must be positioned above the **first** stitch pattern.

- touch the «scroll up»-arrow until the cursor (dotted line) is at the top of the first stitch pattern

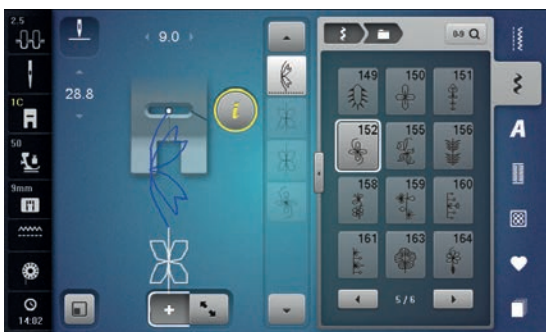

Altering stitch patterns

- select the desired stitch pattern in the combination
- touch the «i»-icon
- select desired function, e.g. Mirror Image left/right
- ▶ the stitch pattern is mirrored left/right
- touch the «Close»- or «i»-icon



The alterations always affect the stitch above the cursor. Saved stitch combinations can be altered or corrected in the same way. To make corrections and alterations permanent, the combination must be saved again afterwards.

Adjusting the length within the combination

The length of all stitch patterns within a combination can be adjusted in relation to the longest stitch pattern.

- touch the «i»-icon
- touch the «Edit whole combination»-icon
- touch the «Stitch length scale»-icon **1**
- ▶ the «Stitch length»-Display appears
- touch the «Length adjustment in combination»-icon **2**
- ▶ the length of all the stitch patterns is adjusted to the longest stitch pattern within the combination



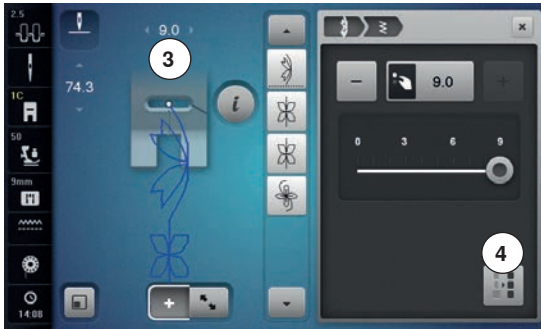

Adjusting the width within the combination

The width of all stitch patterns within a combination can be adjusted in relation to the widest stitch pattern.

- touch the «i»-icon
- touch the «Edit whole combination»-icon
- touch the «Stitch width scale»-icon **3**
- ▶ the «Stitch width»-Display appears
- touch the «Width adjustment in combination»-icon **4**
- ▶ the width of all the stitch patterns is adjusted to the widest stitch pattern within the combination



Mirroring complete combinations

- touch the «i»-icon
- touch the «Edit whole combination»-icon
- touch the «Mirror Image»-icon
- ▶ the complete combination is mirrored
- touch the «Close»- or «i»-icon



Combination subdivider 1

- touch the «i»-icon
- touch the «Edit combination at cursor position»-icon
- touch the «Subdivide combination 1»-icon
- ▶ a combination can be subdivided into several sections with the «Subdivider 1»-function
- ▶ only the section where the cursor is positioned is sewn
- to sew the next section, the cursor must be placed in the respective section



Combination Subdivider 2

- touch the «i»-icon
- touch the «Edit combination at cursor position»-icon
- touch the «Subdivider 2»-icon
- ▶ a combination can be interrupted at any position using «Subdivider 2»-function
- sew the first section
- ▶ the sewing computer stops automatically when it reaches the programmed function
- reposition the fabric
- sew the next part etc.



Combi Mode



Moving individual stitch patterns in a combination

- touch the «Combination overview»-icon
- select desired stitch pattern
- touch the «i»-icon
- touch the «Connecting stitches»-icon
- move the stitch pattern in 0.1 mm steps using the knobs or «+»/«-»-icons or
- move the stitch pattern to any direction using the Touchscreen pen or the finger
- ▶ Connecting stitches are inserted automatically

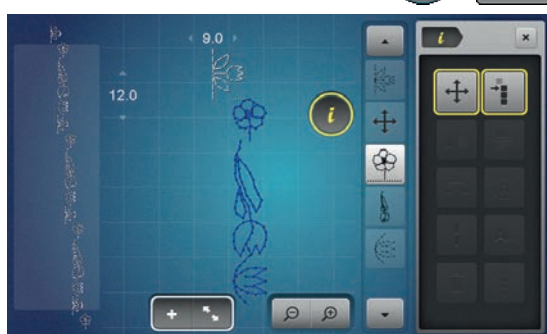

Moving multiple stitch patterns in a combination

- touch the «Modify screen»-icon
- select desired stitch pattern
- touch the «i»-icon
- touch the «Moving combination»-icon
- move the active and any other stitch patterns using the knobs or «+»/«-»-icons, the Touchscreen pen or the finger

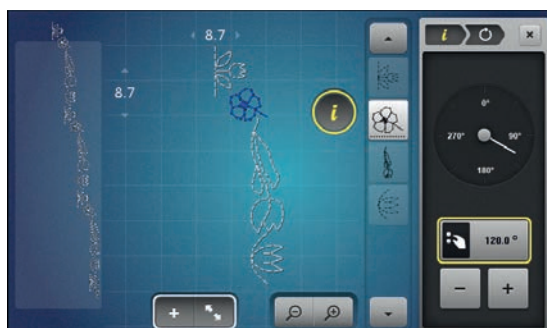

Sewing individual stitch patterns of a combination in any direction

- touch the «Combination overview»-icon
- select desired stitch pattern
- touch the «i»-icon
- touch the «Directional-Sewing»-icon
- rotate the stitch pattern in 0.5°- steps using the stitch width knob
- rotate the stitch pattern in 1°- steps using the stitch length knob
- rotate the stitch pattern in 0.5°- steps using the «+»/«-»-icons



Sewing the complete combination in any direction

- touch the «Combination overview»-icon
- touch the «i»-icon
- touch the «Edit the complete combination»-icon
- touch the «Directional-Sewing»-icon
- rotate the stitch pattern in 0.5°- steps using the stitch width knob
- rotate the stitch pattern in 1°- steps using the stitch length knob
- rotate the stitch pattern in 0.5°- steps using the «+»/«-»-icons

Stitch pattern combination



Overwriting

- program a new stitch combination
 - touch the «Memory»-button
 - touch the «Save»-icon
 - select the drawer to be overwritten (e.g. 3)
 - touch ✓ to confirm
- Touch ✗ to cancel the overwriting procedure.



Deleting

- touch the «Memory»-button
 - touch the «Delete»-icon
 - select the drawer to be deleted (e.g. 5)
 - touch ✓ to confirm
- Touch ✗ to cancel the deleting procedure.

History

History



- press «History»-button



- ▶ the last maximum 24 sewn stitches appear
- ▶ a stitch already contained in the History Display will be overwritten when sewing restarts

Accessory Embroidery

Standard Accessory

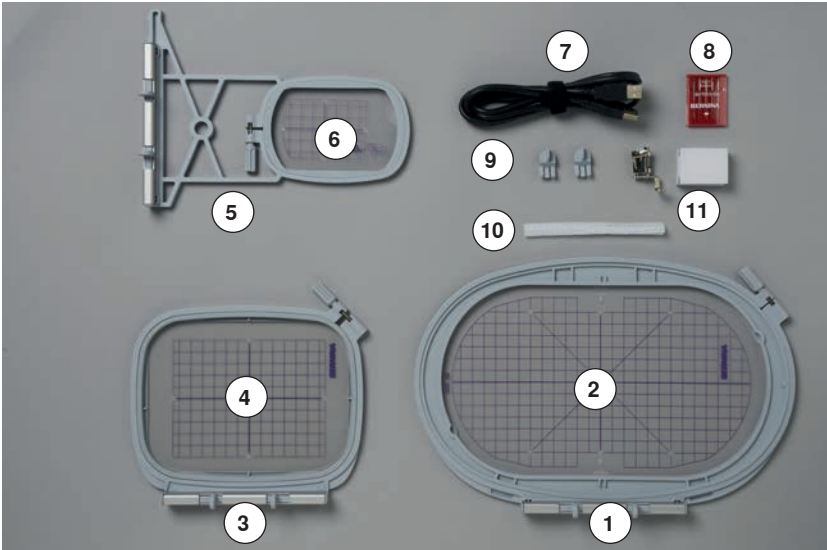

- 1 Embroidery hoop oval, 145x255 mm
- 2 Embroidery template for embroidery hoop oval, VAR 00
- 3 Embroidery hoop medium, 100x130 mm
- 4 Embroidery template for medium embroidery hoop
- 5 Embroidery hoop small, 72x50 mm
- 6 Embroidery template for embroidery hoop small, blue
- 7 USB-connecting cable
- 8 Embroidery needle pack (SUK)
- 9 Template holder
- 10 Net for thread spool, white
- 11 Embroidery foot No. 26

Embroidery module

Detail view



- 1 Embroidery arm
- 2 Sewing computer guide rails
- 3 Bracket for attaching the embroidery hoop
- 4 Connection to the sewing computer



- 5 Connection for the embroidery module

Important Embroidery information

Embroidery threads

A good quality thread is essential for embroidery to avoid poor stitch quality, thread breakage, etc.

Embroidery is particularly effective if you use 40wt glossy rayon or polyester embroidery threads as upper threads. They are available in a wide range of colors for beautiful embroidery.



Polyester threads

Polyester with a brilliant sheen is a hard wearing colorfast thread and has a high tensile strength which is suitable for all types of embroidery.

Rayon threads

Rayon is a soft viscose fiber with a brilliant sheen and suitable for fine, delicate embroidery, or items that will not receive excessive wear and tear.

Metallic threads

Metallic thread is a light- to medium weight thread suitable for special effects in embroidery.

Reduce the speed and upper thread tension when embroidering with metallic threads.

Embroidery needle

- correct size thread must correspond with correct size needle
- replace the needle regularly



When using metallic or specialty threads pull the net over the upper thread spool. This will feed the needle thread more evenly.

Lower threads



Bobbin Fill (special bobbin thread)

Bobbin Fill is an especially soft and light polyester thread suitable for bobbin thread. This special bobbin thread ensures a steady thread tension and an optimal intertwining of the upper and bobbin thread.

Darning and embroidery thread

Fine mercerized cotton thread which suits for embroidering on cotton.



In most cases, bobbin thread for embroidery is either white or black. Some special cases require same thread in top and bobbin.

Choosing the embroidery motif

Simple motifs with a low stitch count are suitable for embroidery on fine material. Large-scale, densely embroidered motifs (e.g. with multiple color and embroidery direction changes) are suitable for medium and heavy weight material.

Embroidery test

Always test stitch the embroidery motif on the same type material. Use the same stabilizer as will be used on the finished project. Changes colors, stabilizer type or needle if needed to suite the motif/fabric combination.

Scaling/Sizing motifs

Motifs can be scaled/sized using the on-screen icons or with the BERNINA Embroidery Software on the PC. Increasing/decreasing in a range of +/- 20% provides the best results.

Selecting the embroidery file format

In order that embroidery motifs can be read by the BERNINA embroidery machine, they have to be created by the BERNINA Embroidery software and exported as .EXP file. Besides the actual embroidery file, a .BMP file and an .INF file are generated additionally. The .BMP file allows a preview of the embroidery motif and the .INF file provides the information on the thread colors. **Please note:** If the .INF file is missing, the embroidery motif cannot be displayed in the real color but only in standard colors. In this case, the colors can be entered manually in the color overview of the motif on the machine. Additionally, following embroidery formats can be read by the machine: .PES, .PEC, .XXX, .PCS, .JEF and .DST. BERNINA International AG doesn't warrant that embroidery motifs which have not been created or converted by the BERNINA Embroidery software can be correctly read and embroidered. Simple motifs with a low stitch count are suitable for embroidery on fine material. Densely embroidered motifs, e. g. embroidered motifs with multiple color and embroidery direction changes, are suitable for medium and heavy-weight material.

Different stitch types

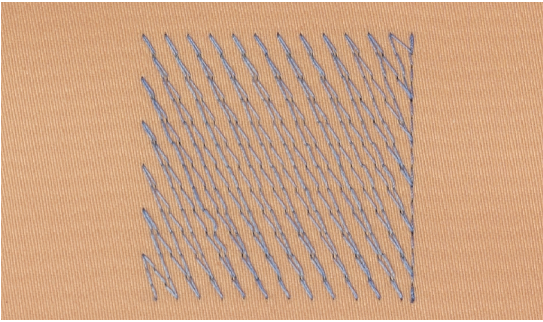

Underlay stitches

Underlay stitches are the foundation of a motif and are used to stabilize the base material and hold it in shape. They also prevent the covering stitches of the motif from sinking into the knit or the nap of the material.

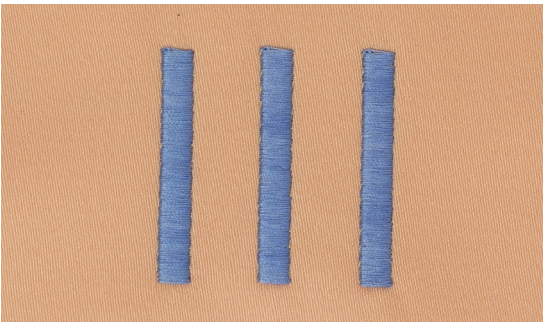

Satin stitch

The needle moves left to right and vice versa. The result is a very dense, covering zig-zag stitching to fill the shape. Satin stitching fills are ideal for narrow and small shapes. Satin stitching is, however, not suitable for larger areas, since wide stitches are too loose and do not cover the fabric properly. In addition there is the danger that with too long stitches the threads could catch on something which would damage the embroidery.

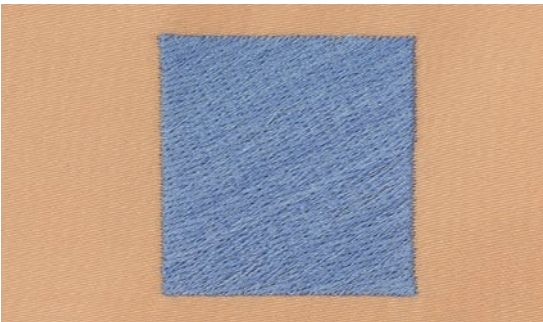

Step stitch

A fill stitch with stitches of specified length sewn in rows used primarily to fill large areas quickly.

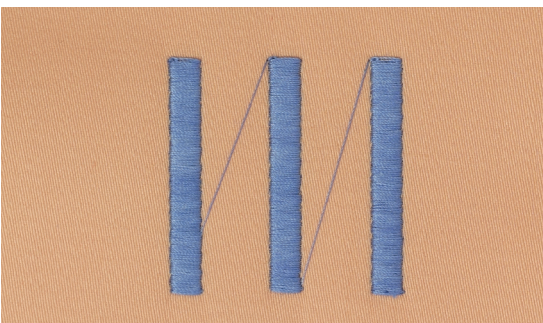

Connecting stitches

Long stitches which are used to get from one part of the motif to the next. Before and after the connecting stitch securing stitches are sewn. Connecting stitches are trimmed before the next color starts to embroider.

Preparing for embroidery

Attaching the Module

ATTENTION!

The slide-on table must not be attached while the embroidery module is being attached or removed. When attaching the embroidery module ensure that all the units are on the same even surface! The embroidery computer may run at high speeds when embroidering. Therefore the two units must be placed on a stable surface or the motor speed reduced when embroidering. Make sure that there is enough space around the sewing computer and embroidery module to allow the unimpeded movement of the embroidery arm! Always separate the sewing computer and the embroidery module from one another before transporting – do not transport them as a unit!

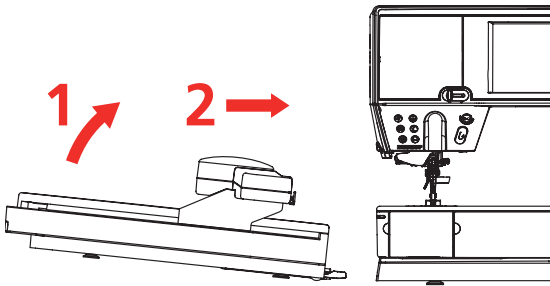

Connecting the module to the sewing computer

- lift the embroidery module on the left and
- carefully slide it from left to right into the sewing computer connection

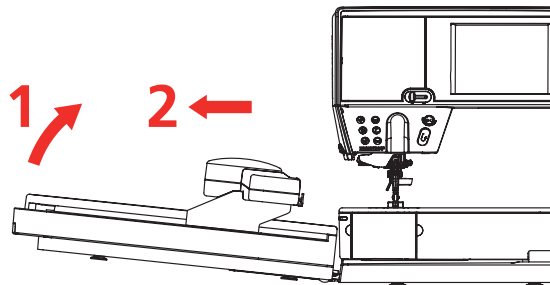

Removing the module from the sewing computer

- lift the embroidery module on the left and carefully pull out and off to the left



Attaching the slide-on table

The slide-on table can only be attached with the embroidery module arm to the far left. If necessary, use the «Park Module» function to move it, see page 172.

Embroidery foot/Embroidery needle

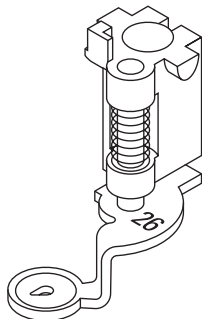

Embroidery needle

Embroidery needles (130/705 H-SUK) provide a larger eye and are slightly rounded. This avoids thread abrasion when using Rayon- and cotton embroidery thread.

- use SUK-needles
- depending on the embroidery thread use a size No. 70-SUK to No. 90-SUK needle
- exchange the needle regularly

Preparation

- attach Embroidery foot No. 26 to the embroidery computer
- raise the presser foot
- raise the needle

Straight-/CutWork stitch plate

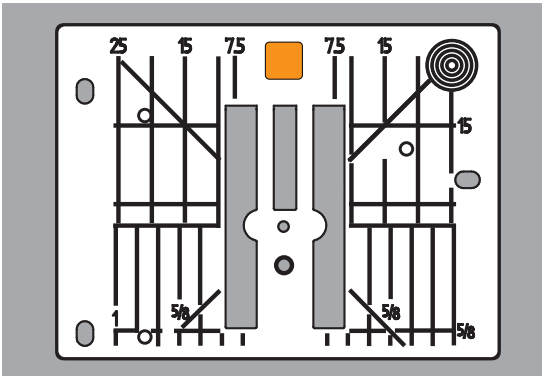

The Straight-/CutWork stitch plate has a small needle hole in the needle insertion area. The small needle hole supports the fabric. This optimizes the stitching results.

- remove the standard stitch plate (see page 27)
- replace it with the straight-/CutWork stitch plate

Threading lower thread

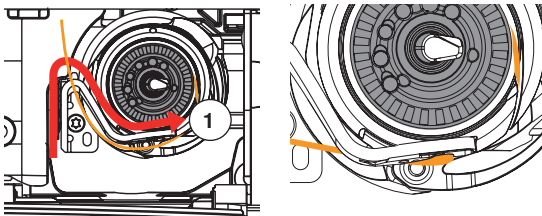

- pull the thread to the right into the slot 1 and then to the left under the spring
- hold the thread into the rounding of the bobbin retainer and guide along the edge to the far right until it hooks in

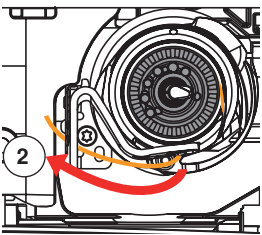

- guide the thread to the left, pull it over the thread cutter 2 and cut



Push the slide-on table to the left first before the bobbin door is opened and operations such as changing the bobbin or threading are carried out.

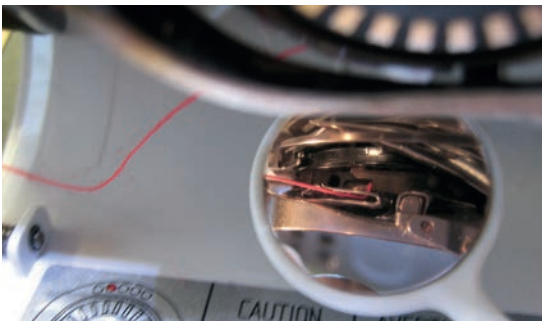

Checking the thread position

- after threading hold the mirror as illustrated under the swivelled out hook
- position of the lower thread threaded for embroidering

Thread-up command

The machine must be ready for embroidery to bring up the bobbin thread. The bobbin thread can be brought up in one step for a manual knotting. If no securing stitches are wanted, it is recommended to deactivate the securing stitches in the Setup.



- hold the upper thread
- push the button «Bobbin thread up»
- ▶ the bobbin thread is brought up automatically

Embroidery hoop

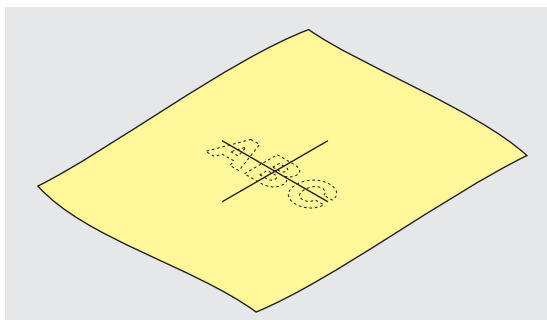

Center determination

- determine the location of the center of the design within the fabric
- mark the material with a fabric marker or chalk

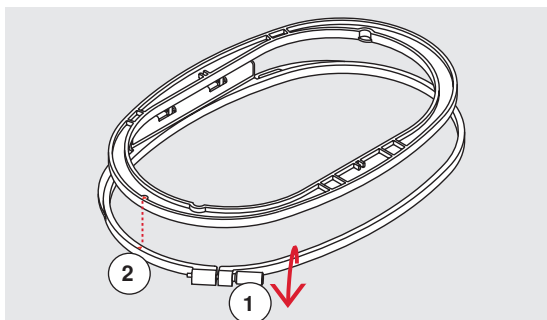

Using the embroidery hoop

- loosen the screw **1** of the outer hoop if necessary
 - remove the inner hoop
- Match the arrows **2** of both hoops.

The arrows are

- on the oval and medium hoop at the center front
- on the small hoop to the right side
- with the Mega-Hoop, the Maxi-Hoop and the Jumbo-Hoop at the front in the center (optional accessory)

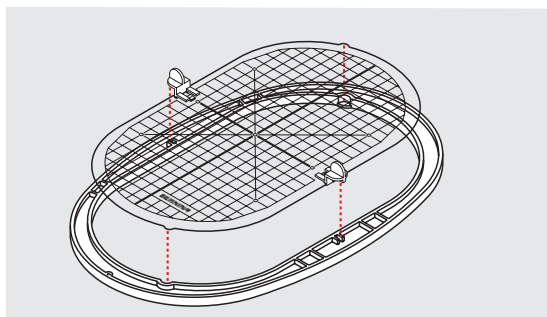

Embroidery template

- there is an embroidery template for each hoop
- the embroidery area is marked in 1 cm squares
- the center and end point are marked with holes
- for transferring marks to the material
- attach the embroidery template holder
- place the template in the inner hoop, so the BERNINA logo is at the front edge (by the arrows) and can be read
- ▶ in this position the embroidery template clicks into the inner hoop

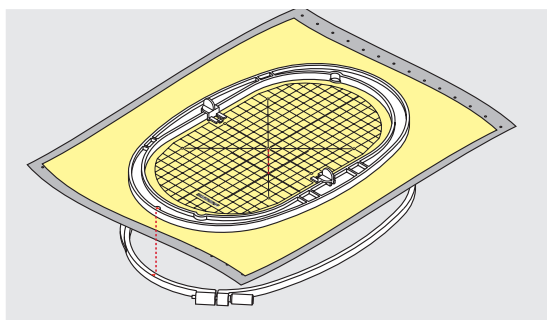

Hooping the material

- place the material under the inner hoop
- line up the marked center point on the center of the template
- place the material and inner hoop on the outer hoop

Match the arrows of both hoops.

- fit hoops into each other; ensure that the material does not move
- hoop the material to be embroidered tightly
- tighten the screw
- remove the template from the hoop by using the template holder

Stabilizer

Stabilizers

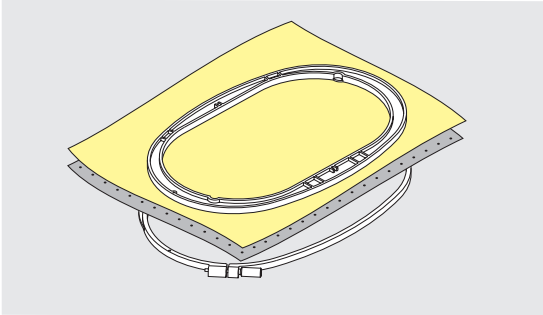

Tear-away stabilizers

- excess is easily torn away
- one or more layers can be used
- available in different weights
- for more stability, apply to the wrong side of the material with temporary adhesive spray before hooping
- carefully tear away excess stabilizer from the back of the embroidery after stitching
- motifs are not skewed
- stabilizer will remain under larger embroidered areas

Application:

For all woven materials and materials without stretch.

Cut-away stabilizers

- one or more layers can be used
- available in different weights
- for more stability, apply to the wrong side of the material with temporary adhesive spray before hooping
- carefully cut away from the back of the embroidery after stitching
- motifs are not skewed
- stabilizer will remain under larger embroidered areas

Application:

For all elastic materials.

Adhesive Spray

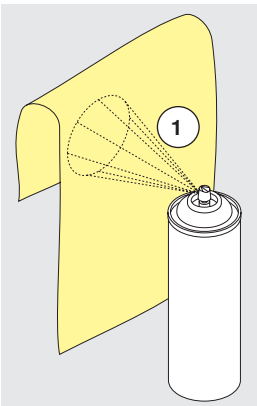

Avoid using spray adhesive next to your embroidery system.

- at a distance **1** of 25-30 cm
- use adhesive spray carefully
- spray the stabilizer and adhere to the wrong side of the material carefully smoothing material so there are no puckers

Application:

- stretch and knitted material: to retain shape
- smooth material: to avoid slipping of material layers
- appliqués can be exactly positioned
- material pieces: position material pieces on stabilizer, e.g.pocket flaps
- napped materials (i.e. velvet) that should not be clamped in the hoop because of the possibility of getting hoop marks
- to fix parts to be embroidered

Spray starch for additional stiffening

Spray starch is ideal for additional stiffening fine, soft or loosely woven materials.

- spray the area to be embroidered
- let dry; or press gently with a warm iron if necessary

Always use an additional stabilizer such as water soluble stabilizer on the wrong side of the material.

Application:

Ideal for fine, loosely woven materials, e.g. batiste, fine linen, etc.

Iron-on interfacing

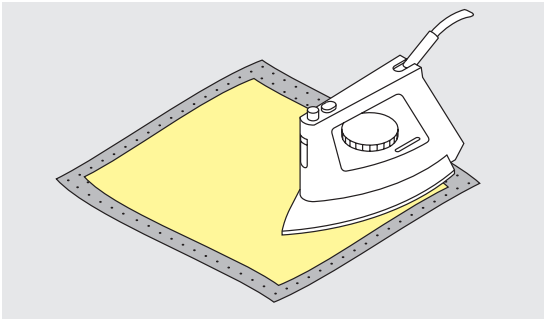

Iron-on interfacings are available in a variety of weights. Iron-on interfacings should be selected to suit the material being used. Use an iron-on interfacing which is easily removable from the material.

- iron-on interfacings are pressed (fused) to the wrong side of the material

Application:

To provide body and shape for materials onto which motifs will be placed, use in conjunction with appropriate stabilizer.

Paper-backed adhesive stabilizer

- place stabilizer in hoop, paper side up
- use a pointed object (e.g. scissors) to score the paper
- remove paper to reveal the self-adhesive surface
- ▶ the self-adhesive surface reveals
- position the material to be embroidered on the stabilizer and smooth in place

Application:

- intended for delicate materials such as jersey or silk etc.
- for hard-to-hoop parts and materials



Make sure that the adhesive residue on needle, stitch plate and hook area is removed.

Water soluble stabilizer

Water soluble stabilizer looks like plastic wrap. Dissolve stabilizer in warm water when the embroidery is complete. Water soluble stabilizers are ideal protection for materials with a thick or looped pile such as toweling. This prevents the threads from sinking into the material and prevents the material from showing through the embroidery stitches.

- place on top of the material
- place all the layers together into the embroidery hoop
- use adhesive spray to fix stabilizer if necessary
- for material with a pile, reinforce with additional, suitable stabilizer on the wrong side
- after dissolving lay the motif down flat and let dry

Application:

- ideal for toweling, velvet, bouclé etc.
- ideal for fine, sheer materials such as organdy, batiste, etc.
- for lace embroidery



For lace embroidery place one or two layers of water soluble stabilizer in hoop (as the motif is not embroidered on any material, only the thread embroidered motif is left). Embroidery motifs must be combined with short stitches otherwise the individual motifs may fall out.

Functions

Overview «Function»-buttons embroidery computer



1 «Start/Stop»-button

Press the button to start or stop the embroidery computer.



2 «Automatic thread cutter»-button

- press the button
- ▶ the upper and the lower thread are cut automatically



3 «Presser foot position»-button

- press the button
- ▶ the presser foot is lowered and raised a bit again for easy positioning of the material
- ▶ the presser foot is lowered on the fabric when embroidering is started
- press the button again
- ▶ the embroidery foot is raised



4 «Automatic threading»-button

- press the button = finishing the threading process and threading the needle

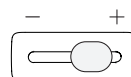

5 Slide speed control

The embroidering speed is infinitely variable with the slide.

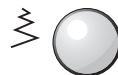

6 Stitch width and stitch length knob

The knobs are used to control a variety of functions, including altering motif size, rotating the motif etc. A message appears to indicate which knob should be used.



Only these listed icons are active in the embroidery mode.

Overview Display

Entry to Embroidery mode

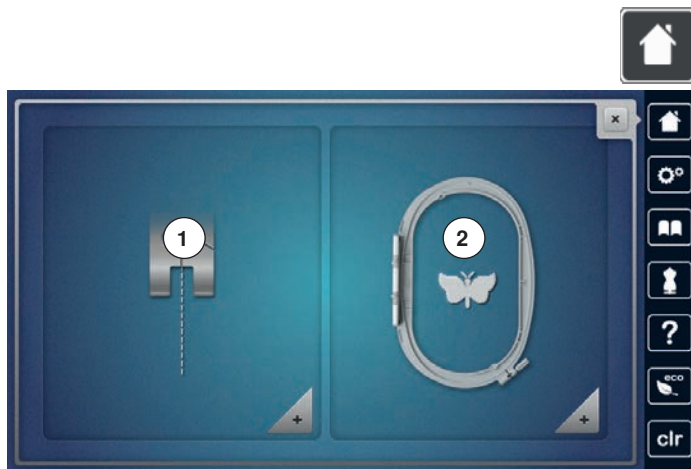

- press the «Home»-button

Embroidery mode

- touch the «Embroidery mode»-icon 2
- ▶ the «Embroidery»-Display appears

Sewing mode

- touch the «Sewing mode»-icon 1
- ▶ the «Sewing»-Display appears

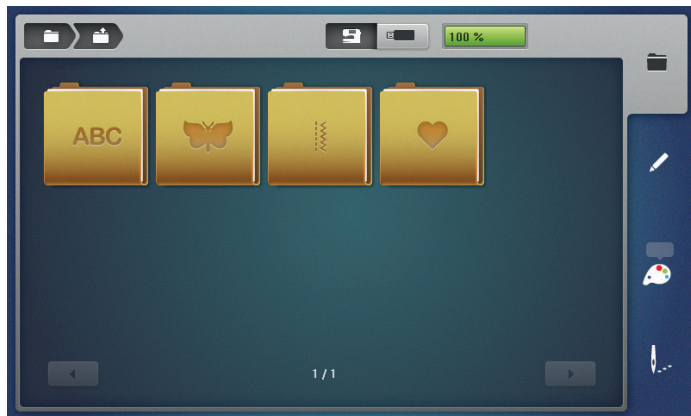

Embroidery computer

To select embroidery motifs from the folders «Alphabets», «Motifs», «Stitch patterns» or «My Designs».



USB stick

To select embroidery motifs which are stored on the USB stick.



Alphabets

To select built-in alphabets.



Embroidery motifs

To select built-in embroidery motifs.



Stitch patterns

To select integrated stitch patterns.



My Designs

To select saved embroidery motifs.

Embroidery consultant

Overview Embroidery consultant

The Embroidery consultant provides information and decision support concerning embroidery projects. After entering the material and the desired sewing technique, suggestions for the suitable needle, presser foot, etc. are displayed.

- ▶ the presser foot pressure and the upper thread tension are adjusted automatically
- press the button «Embroidery consultant»
- ▶ the display of the Embroidery consultant appears

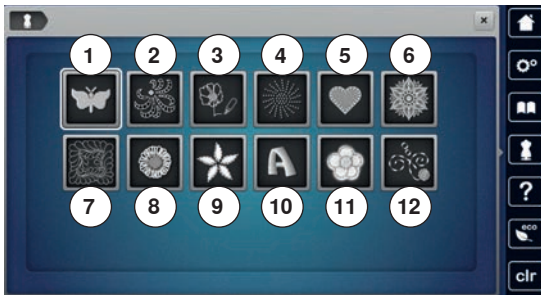

- 1 Embroidering
- 2 CutWork
- 3 PaintWork
- 4 CrystalWork
- 5 Embroidery appliqué
- 6 Freestanding lace
- 7 Quilting
- 8 Fringed embroidery
- 9 Trapunto
- 10 Puffy lettering
- 11 PunchWork
- 12 Couching

Overview Material

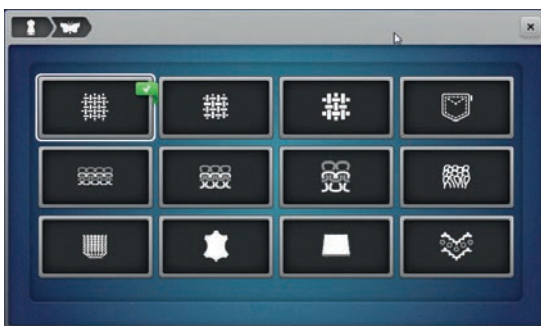

- touch the icon of the desired project, e.g. Embroidering

- 1 Light woven
- 2 Medium-weight woven
- 3 Heavy-weight woven
- 4 Jeans
- 5 Light knitware
- 6 Medium-weight knitware
- 7 Heavy-weight knitware
- 8 Toweling
- 9 Pile fabrics
- 10 Leather and vinyl
- 11 Felt
- 12 Tulle and laces

Overview Embroidery techniques/ recommendations



- touch the icon of the wanted material, e.g. light woven
- If the wanted embroidery technique is not available in the list, select a similar embroidery technique
- ▶ recommendations for the selected material and the desired embroidery technique are displayed
- confirm with ✓

Embroidery Alphabet



- touch the «Alphabet»-icon

- select the desired alphabet

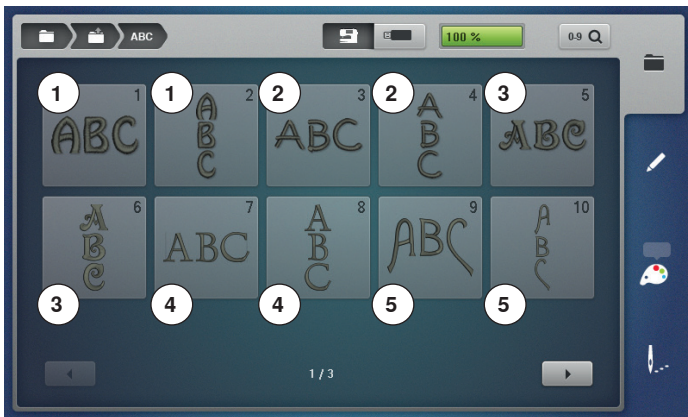

- 1 Drifter
- 2 Childs Play
- 3 Victoria
- 4 King Charles
- 5 Alice



- 6 Chicago
- 7 Anniversary
- 8 Swiss Block
- 9 Quilt Block
- 10 Old English
- 11 Russian Textbook



- 12 Jikharev
- 13 Bamboo
- 14 Lisa
- 15 Zuerich
- 16 Flare serif
- 17 Deco block
- 18 Condensed sans
- 19 Curly



20 Happy Times
21 Rounded sans



ABC

Back to Folder menu

Back to the «Folder»-Display.



Back to selection menu

Back to the «Selection»-Display.

Overview Display

BERNINA Embroidery motifs



- touch the «Motif»-icon

- ▶ the Display shows the overview with the embroidery motif folder

- 1 Exotic Rainforest
- 2 Floral Etchings
- 3 Diane Gaudynski Quilting
- 4 Projects
- 5 Shaping Designs
- 6 Monograms
- 7 DesignWorks
- 8 BERNINA Classic Collection
- 9 Projects
- 10 Charming Monograms

- 11 Homedeco

- select the desired embroidery motif folder

BERNINA Stitch patterns

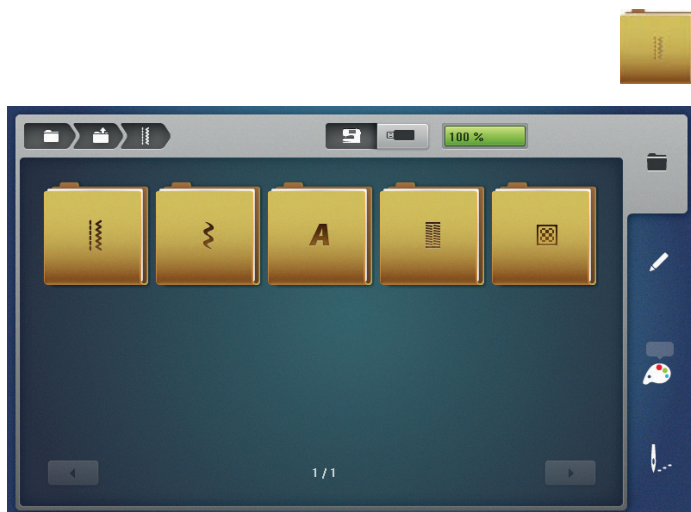

- touch the «Stitch pattern»-icon

- select the desired stitch pattern folder
- ▶ all stitch patterns contained in the sewing mode can also be embroidered

My Designs



- touch the «My Designs»-icon
- touch the desired motif



Embroidery motif from USB stick



- insert USB stick
- touch the «USB stick»-icon
- touch the desired motif or folder



«Edit»-Display

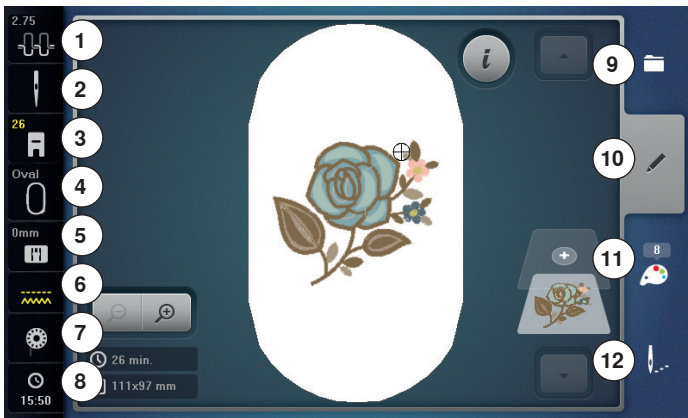

- 1 Undo
- 2 Redo
- 3 Upper thread tension
- 4 Security needle
- 5 Presser foot Indicator/Presser foot selection
- 6 Select hoop/Hoop Indicator
- 7 Security stitch plate
- 8 Feed dog recognition
- 9 Filling bobbin
- 10 Time Display
- 11 Selection
- 12 Edit
- 13 Color number
- 14 Embroidery menu



Undo

- all entries can be undone and redone again step by step



Redo

- all entries can be undone and redone again step by step



Upper thread tension

- ▶ the current value is visible in the icon



Security Program

- touch the «Needle»- or «Stitch plate»-icon
- touch the desired «Needle»- and/or «Stitch plate»-icon
- ▶ if an inappropriate stitch plate is selected, a warning will appear in the icon



Presser foot Indicator/Presser foot selection

Embroidery foot No. 26 is displayed by default.

- touch the icon
- ▶ additional presser feet, such as Free motion couching foot No. 43, are displayed and can be selected
- attach and select the appropriate presser foot for the project



Select hoop/Hoop Indicator

- ▶ the optimal hoop for the motif selected is displayed
- touch the icon
- ▶ the Display with the Select Hoop and further functions appear



Feed dog recognition

In Embroidery Mode the feed dog is lowered automatically by default and indicated by the yellow feed dog symbol.



Filling bobbin

The remaining thread on the bobbin is displayed.

- touch the icon
- ▶ an animation shows how to thread the bobbin



Time Display

The time is displayed.

- touch the icon
- ▶ an alarm time and a personal alarm message can be programmed



Selection

- select a new motif
- add a motif
- save the motif
- delete the motif



Edit

In this Display the motif can be edited.



Color number

Display of the motif color numbers.

- touch the icon
- ▶ Display providing the color information to the selected motif is opened



Embroidery menu

- ▶ the «Embroidery»-Display is opened
- ▶ the Embroidery computer is ready to embroider



The Embroidery computer must be started by pressing the «Start/Stop»-button on the headframe.

Overview «Edit»-Display

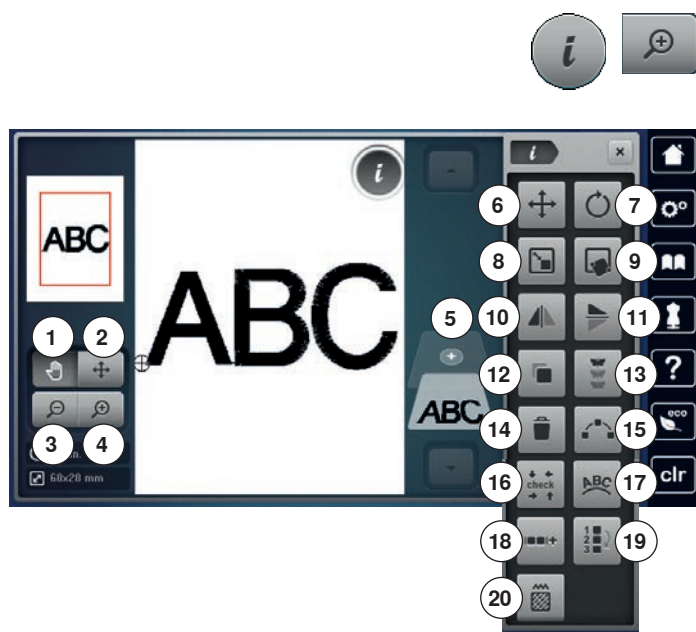

- select alphabet or motif
- touch the «i»-icon
- touch the «Zoom plus»-icon

Some functions feature tips for the operating of the stitch width and stitch length knobs.

Functions

- 1 Move the view of the motif
- 2 Move the view of the motif within the hoop
- 3 Zoom minus
- 4 Zoom plus
- 5 Add a motif
- 6 Move motif
- 7 Rotate motif
- 8 Alter the embroidery size
- 9 Pinpoint placement
- 10 Mirror Image left/right
- 11 Mirror Image down/up
- 12 Duplicate
- 13 Endless Embroidery
- 14 Delete motif
- 15 Shaping
- 16 Check motif size
- 17 Letter manipulation
- 18 Grouping embroidery motifs
- 19 Changing the sequence within an embroidery motif combination
- 20 Altering the stitch type/stitch density

Scrolling Functions

When not all the functions are displayed directly, proceed as follows:

- touch the «Function»-Display with the finger or the Touchscreen pen, keep it touched and scroll upwards
- ▶ additional functions appear

General Functions



Information

- touch the icon
- ▶ another Display opens



Close

- touch the icon
- ▶ the previous Display appears
- ▶ any alterations are accepted



Confirm selection

- touch the icon
- ▶ alteration/selection is activated or confirmed



Escape Display

- touch the icon
- ▶ the Display closes
- ▶ the previous Display appears



Move the view of the motif

The view of the embroidery motif can be moved to any direction using finger or the Touchscreen pen directly in the Display. The embroidery position won't be changed.



Move the view of the motif within the hoop

The embroidery motif can be moved within the hoop to any direction using finger or the Touchscreen pen directly in the Display.



Zoom minus

- touch the icon 1-5x
- ▶ the view of the enlarged motif is reduced by one step



Zoom plus

- touch the icon 1-5x
- ▶ the view of the embroidery motif is enlarged by one step



Add a motif

- ▶ the overview of the previous Display is opened (Alphabet, Motifs, Stitch patterns, My Designs)
- select the desired motif



Move motif

Display of the alteration in 1/10 mm.

- turn the stitch width knob
- ▶ the motif is moved in sideways (horizontally)
- turn the stitch length knob
- ▶ the motif is moved lengthwise (vertically)
- turn stitch width and stitch length knob
- ▶ the motif is moved diagonally (the same number is in both icons)

By using the finger or the Touchscreen pen the motif can also be moved to any direction directly in the Display.



Rotate motif

Display of position in degrees (°).

- turn the stitch width knob to the right
- ▶ the motif rotates to the right
- turn the stitch width knob to the left
- ▶ the motif rotates to the left
- touch the «+90»-icon 1-4x
- ▶ the motif rotates to the right in 90°-steps (90°, 180°, 270°, 360°)



Alter the embroidery size

The embroidery motif can be altered proportionally or unproportionally.

Displayed alteration in %.



Pinpoint placement

This function allows exact positioning of embroidery motifs on the fabric in an easy way. The points can be defined as you like within the embroidery motif.



Mirror Image left/right

The motif is mirrored horizontally (left/right).



Mirror Image down/up

The motif is mirrored vertically (down/up).



Duplicate

Active embroidery motif is duplicated.



Endless Embroidery

Opens to display to combine a border.



Delete motif

Active embroidery motif is deleted.

Motif may also be deleted by swiping.

- touch the layer to delete by Touchscreen pen or finger and move it to the right or left
- ▶ the motif is deleted



Shaping

The Display opens and the motifs can be arranged in different formations.



Check motif size

The motif size is traveled by the four arrow icons.

- touch the «Motif center»-icon
- ▶ the needle moves to the center position of the motif
- turn the stitch width knob
- ▶ the motif is moved horizontally
- turn the stitch length knob
- ▶ the motif is moved vertically



Letter manipulation

- turn stitch width knob
- ▶ the distance between the characters is altered in mm-steps
- turn the stitch length knob
- ▶ the text is bent upwards or downwards



Grouping embroidery motifs

Embroidery motifs can be added to a combination or removed. The grouped embroidery motifs can be edited like one single embroidery motif.



Changing the sequence within an embroidery motif combination

The sequence of the embroidery motifs within the embroidery motif combination can be changed.



Altering the stitch type/stitch density

- satin stitches can be changed to step stitches (fill stitches)
- alter stitch density

Overview Display

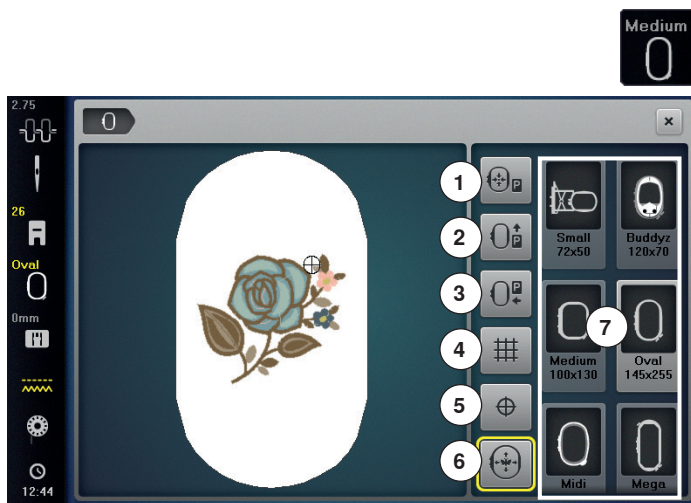

- touch the «Hoop size»-icon

Functions

- 1 Hoop relocator
- 2 Park embroidery hoop
- 3 Move the embroidery hoop to the left
- 4 Show Grid
- 5 Motif center
- 6 Virtual positioning
- 7 Select hoop/Hoop Indicator



Hoop relocator

- ▶ the hoop moves to the center
- press the «Start-/Stop»-button
- ▶ the hoop moves back to the previous position



Park embroidery hoop

- ▶ the hoop moves vertically to the far back
- Better access for changing the bobbin.



Move the embroidery hoop to the left

- removing the hoop
- ▶ the embroidery arm travels horizontally to the left to the park position
- change to the sewing mode
- Sewing is possible even with the embroidery module attached.



Show Grid

- touch the icon
- ▶ a large cursor shows the center of the hoop
- touch the icon again
- ▶ the grid appears
- the motif can be positioned more exactly



Motif center

The exact motif center is indicated by the cursor. The hoop is moved until the needle is exactly in the center of the motif, when the function «Virtual Positioning» is activated.



Virtual positioning

Icon is inactive = if the motif is repositioned, the hoop does not move.



- touch the icon
- If the motif is repositioned, the hoop simultaneously moves along with it to the new position.
- This function is only visible when an embroidery hoop is attached.



Select hoop/Hoop Indicator

- ▶ the optimal hoop for the motif selected is displayed
- touch the icon
- ▶ the Display with the Select Hoop and further functions appear

Overview Embroidery menu

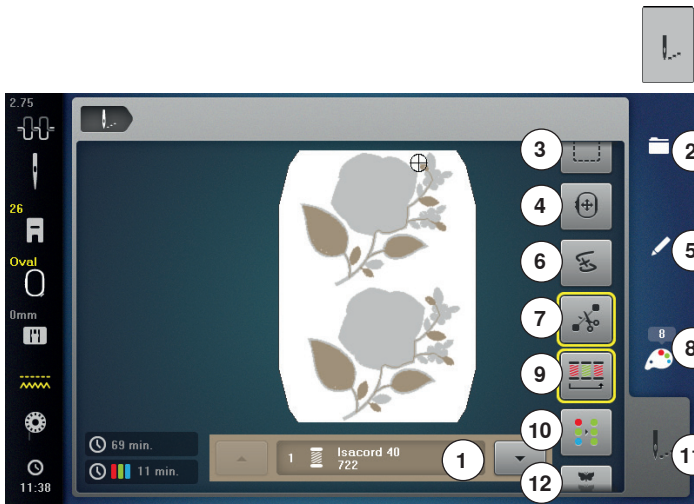

- press the «Embroidery menu»-button

Some functions feature tips for the operating of the stitch width and stitch length knobs.

Functions

- 1 Color information
- 2 Selection
- 3 Basting
- 4 Move hoop
- 5 Edit
- 6 Embroidery sequence control
- 7 Cutting connecting stitches
- 8 Color number
- 9 Color resequence
- 10 Single/Multi-color motif
- 11 Embroidery menu
- 12 Endless embroidery



Color information

Information about the active color.

- touch the arrow icons up or down
- ▶ the current color is changed
- ▶ the hoop moves to the first stitch of the current color

The active color can also be embroidered individually or in another sequence.



Cutting connecting stitches

Generally, the function is active (yellow-framed). Connecting stitches are automatically cut.

- touch the icon
- connecting stitches must be trimmed manually



Color number

Display of the motif color numbers.

- touch the icon
- ▶ Display providing the color information to the selected motif is opened



Selection

- select a new motif
- add a motif
- save the motif
- delete the motif



Basting

- touch the icon
- ▶ the embroidery motif is outlined with a straight stitch
- touch the icon again, the symbol changes
- ▶ the basting is now done along the hoop
- touch the icon again
- ▶ basting stitches are deactivated



Move hoop

If the fabric has to be re-hooped when stitching a large embroidery motif (e.g. lettering, borders etc.), the hoop has to be moved to the last stitch of the already embroidered part via the stitch width and stitch length knob.

- ▶ the movement is displayed in the icons



Edit

In this Display the motif can be edited.



Embroidery sequence control

In the left portion of the Display the current color of the motif is shown in the normal size. In the right portion of the Display the motif is enlarged.



Embroidering the motif by color

With the icon deactivated, the number and sequence of colors remain as initially set.



Reducing color changes

With the icon activated, the motif sections with identical colors are resequenced and color changes reduced.



Single/Multi-color motif

If the icon is active, the entire motif will be embroidered in one color (without stopping).

If the icon is inactive, the colors will be embroidered individually.



Embroidery menu

- ▶ the «Embroidery»-Display is opened
 - ▶ the Embroidery computer is ready to embroider
- The Embroidery computer must be started by pressing the «Start/Stop»-button on the headframe.



Endless embroidery

Allows to resume embroidering borders which have already been started even if the machine has been switched off and on again.

Overview Selection menu



- press the «Selection»-button

Functions

- 1 Open new motif
- 2 Add motif
- 3 Save motif
- 4 Delete motif



Open new motif

- ▶ the overview of the previous Display is opened (Alphabet, Motifs, Stitch patterns, My Designs)
- select the desired motif



Add motif

- ▶ the overview of the previous Display is opened (Alphabet, Motifs, Stitch patterns, My Designs)
- select the desired motif



Save motif

- ▶ the «Save»-Display is opened



Delete motif

- ▶ the «Delete»-Display opens

Overview Color Display



- press the «Color number»-button



Color wheel

- touch the icon
- ▶ the «Color wheel»-Display opens



Change thread brand

- touch the icon
- ▶ various thread brands appear in the Display



Motif color information

- touch the «up/down»-icons to move through the motif color information



Motifs

Selecting a motif



Various embroidery motifs from the «Alphabets», «Motifs», «Stitch patterns» and «My Designs» files can be selected.

Alphabets



Selecting alphabet

- touch the «Alphabet»-icon
- ▶ various alphabet types appear in the Display
- touch the desired «Alphabet»-icon or use the «0-9»-icon to select the desired alphabet



Entering/Correcting lettering

- ▶ the Display with the keyboard opens
- ▶ the «ABC»-icon (upper case) is active automatically
- select the desired characters

The space bar is at the bottom of the letter keys.

- ▶ the letters appear in the text bar 1
- touch ✓ to confirm

Deleting lettering

- touch text bar 1
- ▶ all entered text is deleted

Corrections

- touch the icon 2
- ▶ the entered text is deleted from right to left

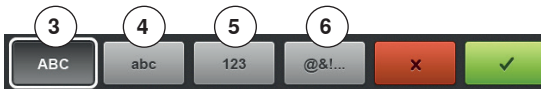

3 «ABC» upper case characters (standard)

4 «abc» lower case characters

5 «1,2,3» numbers and mathematical characters

6 «@&!...» special characters



If all the lettering cannot be displayed in the hoop, rotate the lettering by 90°. There is then more room for the lettering in the entire length of the embroidery hoop.
If this does not help, decrease the lettering size or reduce the number of letters.

BERNINA embroidery motifs

All BERNINA embroidery motifs can either be embroidered as-is, or edited using the various functions offered by the embroidery computer.



Motif Overview

The motifs are displayed in folders according to topics.

- touch the «Motif»-icon
- select folder
- select the desired motif

Stitch patterns

The stitch patterns can be found in the same category folders as in the sewing mode.



Stitch pattern overview

- select folder
- select the desired stitch pattern

My Designs

All embroidery designs can either be embroidered as-is, or edited using the various functions offered by the embroidery computer.

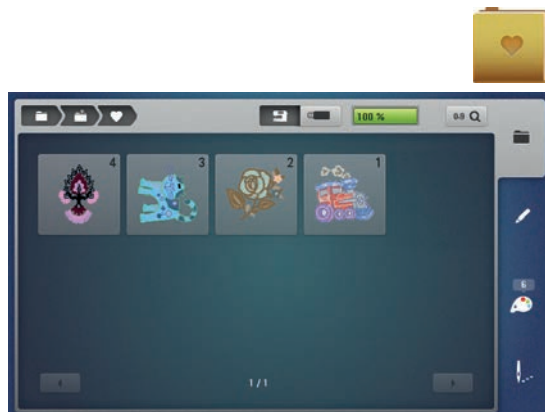

Motif Overview

- touch the «My Designs»-icon
- select the desired motif touching the icon or via the «0-9»-icon

Motifs in combination with functions

To activate the functions touch the appropriate icon and make adjustments via the stitch width and stitch length knobs.

Moving the motif

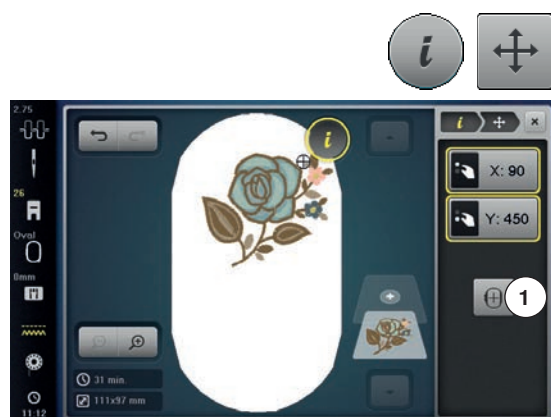

- touch the «i»-icon
- touch the «Move motif»-icon
- turn the stitch width knob
- ▶ the motif is moved in sideways (horizontally)
- turn the stitch length knob
- ▶ the motif is moved lengthwise (vertically)
- ▶ the alteration is displayed in the icons in 1/10 mm
- turn the stitch width and stitch length knob
- ▶ when both icons display the same number, the motif has been moved diagonally
- touch the yellow-framed icon or the «Center»-icon 1
- ▶ the motif is repositioned to the center of the hoop

Rotating the motif

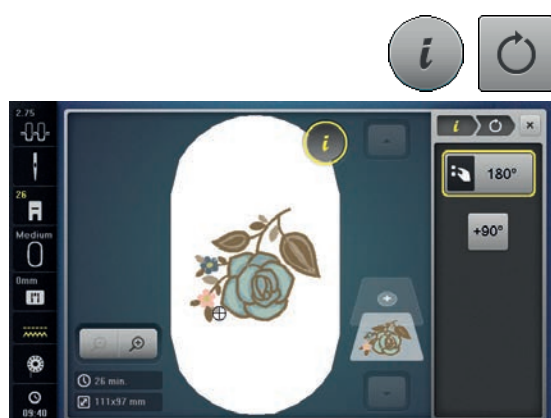

- touch the «i»-icon
- touch the «Rotate motif»-icon
- turn the stitch width/stitch length knob to the right
- ▶ the motif rotates to the right
- turn the stitch width/stitch length knob to the left
- ▶ the motif rotates to the left
- ▶ the position is displayed in the icon in degrees (°)
- touch the yellow-framed icon
- ▶ the position of the motif is reset to basic setting (0°/360°)
- touch the «+90»-icon 1-4x
- ▶ the motif rotates in 90°-steps (90°, 180°, 270°, 360°)

Altering the embroidery motif size proportionally

If the icon «Retain the proportions» is framed in white, the embroidery motif is altered proportionally.

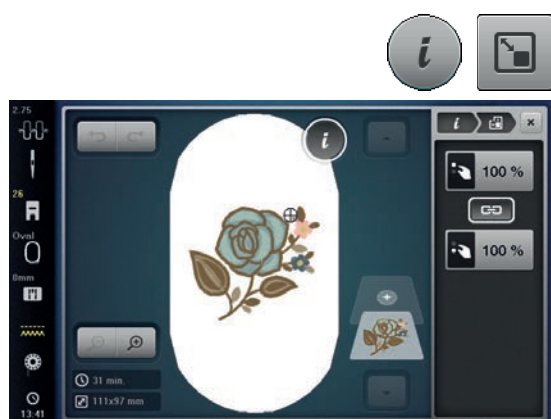

- touch the icon «i»-Dialog
- touch the icon «Alter the embroidery size»
- ▶ turn the «Upper/Lower Multifunctional knob» to the right to scale up the embroidery motif proportionally
- ▶ turn the «Upper/Lower Multifunctional knob» to the left to downsize the embroidery motif proportionally

Altering the embroidery motif size disproportionately

If the icon «Retain the proportions» is **not** outlined in white, the embroidery motif is altered disproportionately.

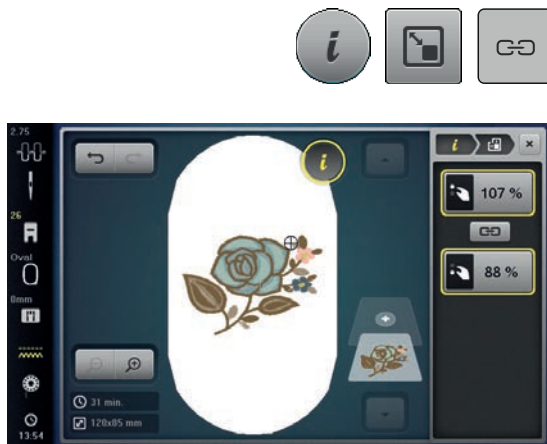

- touch the icon «i»-Dialog
- touch the icon «Alter the embroidery motif size» to alter the embroidery motif width and height independent on each other
- touch the icon «Retain the proportions»
- turn the «Upper Multifunctional knob» to alter the embroidery motif horizontally
- turn the «Lower Multifunctional knob» to alter the embroidery motif vertically
- ▶ the embroidery motif is not scaled up or downsized proportionally

Mirror motifs

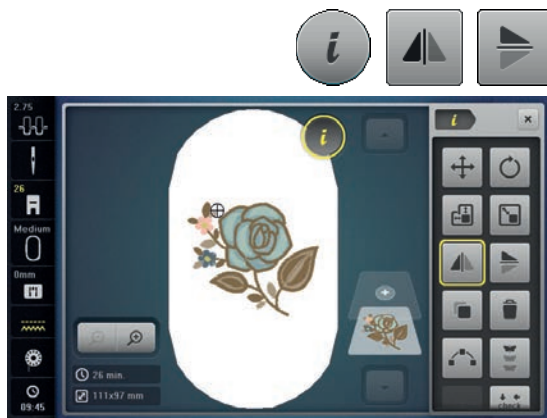

- touch the «i»-icon
- touch the «Mirror Image left/right»-icon
- ▶ the motif will be mirrored horizontally
- touch the «Mirror Image up/down»-icon
- ▶ the motif will be mirrored vertically

Pinpoint placement

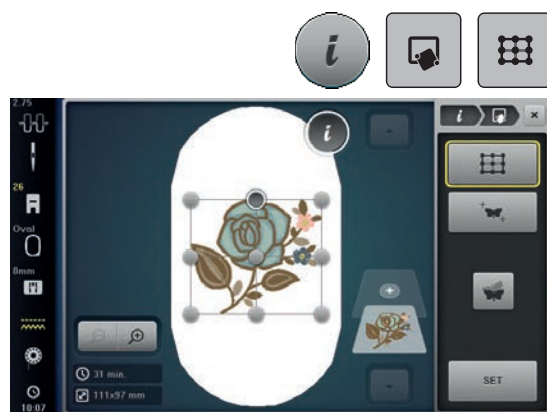

Pinpoint placement

This function allows the exact positioning of the embroidery motif on the fabric in an easy way. The positioning points can be placed in the grid.

Prerequisite: Any two points of the embroidery motif are marked with chalk or a water-soluble pen on the fabric. The place or the location where the embroidery motif is to be positioned is clearly visible.

- touch the icon «i»-Dialog
- touch the icon «Pinpoint placement»
- touch the icon «Grid»
- ▶ the embroidery motif is given a grid with nine different location/positioning points
- select the desired positioning point to which the embroidery motif is to be adjusted
- ▶ the point changes its color
- turn the «Upper Multifunctional knob» or the «Lower Multifunctional knob» to the left or to the right to position the needle above the respective mark on the fabric
- touch the icon «SET» to confirm the altered position
- ▶ the point changes its color and is defined

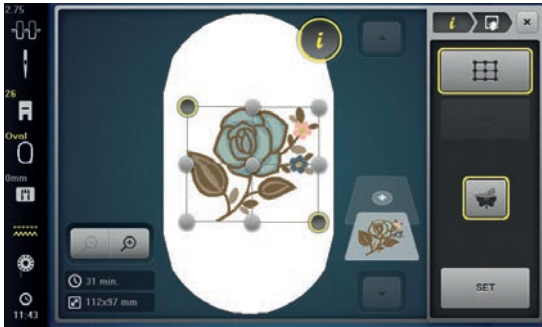

- select the second positioning point of the embroidery motif
- turn the «Upper Multifunctional knob» or the «Lower Multifunctional knob» to the left or to the right to position the needle above the respective mark on the fabric
- touch the icon «SET» to confirm the altered position
- ▶ the point changes its color and is defined. The embroidery motif is adjusted accordingly
- touch the icon «Reset Pinpoint placement» to reset the alterations to default setting



Free point positioning

This function allows exact positioning of embroidery motifs on the fabric in an easy way. The points can be defined as you like within the embroidery motif. Prerequisite: Any two points of the embroidery motif are marked with chalk or a water-soluble pen on the fabric. The place or the location where the embroidery motif is to be positioned is clearly visible.



- touch the icon «i»-Dialog
- touch the icon «Pinpoint placement»
- touch the icon «Place points as desired»
- define a desired point within the embroidery motif
- ▶ the positioning point is displayed
- turn the «Upper Multifunctional knob» or the «Lower Multifunctional knob» to the left or to the right to position the needle above the respective mark on the fabric



- touch the icon «SET» to confirm the altered position
- ▶ the point changes its color and is defined
- select the second positioning point of the embroidery motif
- turn the «Upper Multifunctional knob» or the «Lower Multifunctional knob» to the left or to the right to position the needle above the respective mark on the fabric
- touch the icon «SET» again to confirm the altered position
- ▶ the point changes its color and is defined. The embroidery motif is adjusted accordingly
- touch the icon «Reset Pinpoint placement» to reset the alterations to default setting

Grouping embroidery motifs

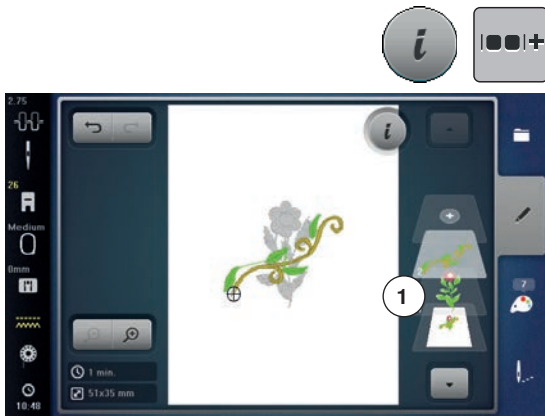

Embroidery motifs can be added to a combination or removed. The grouped embroidery motifs can be edited like one single embroidery motif. The sequence of the embroidery motifs in the combination can be changed. As soon as an embroidery motif has been ungrouped, in other words, it has been decomposed in different elements/colors, the colors won't be recomposed. With alphabets, the jumpstitch length needs to be adjusted to 1 in the Setup so that ungrouping will work with all the letters.

- create an embroidery motif combination
- select an embroidery motif (1) within the embroidery motif combination
- touch the icon «i»-Dialog
- touch the icon «Group»
- touch the icon «Group»
- ▶ the embroidery motif above the selected embroidery motif is added to the embroidery motif combination
- select an embroidery motif combination
- touch the icon «Ungroup»
- ▶ the combination is ungrouped

or

- create an embroidery motif combination
- select all embroidery motifs (2)
- touch the icon «i»-Dialog
- touch the icon «Group»
- ▶ all embroidery motifs are added to the embroidery motif combination
- select an embroidery motif combination
- touch the icon «Ungroup»
- ▶ the combination is ungrouped

Changing the sequence within an embroidery motif combination



The sequence of the embroidery motifs within the embroidery motif combination can be changed. The embroidery motif combination has been created or the motif has been ungrouped.

- touch the icon «i»-Dialog
- touch the icon «New Allocation»
- touch the icon «Scroll up» to position the selected embroidery motif further up within the sequence
- touch the icon «Scroll down» to position the selected embroidery motif further down within the sequence

Undoing entries



All entries can be undone and redone again step by step.

Prerequisite: An embroidery motif has been selected and alterations have been done.

- touch the icon «Undo» to cancel the last entry
- touch the icon «Undo» several times to cancel the last entries step by step
- touch the icon «Redo» to restore the last entry
- touch the icon «Redo» several times to restore the last entries step by step

Select hoop



- touch the «Select hoop»-icon

For best embroidery results always use the smallest hoop possible for the motif.

- select the desired hoop
 - ▶ the selected hoop is framed in white and marked in the corner top right
- touch the «Select hoop» or the «close»-icon
 - ▶ the Display closes
 - ▶ the embroidery motif appears in the selected hoop

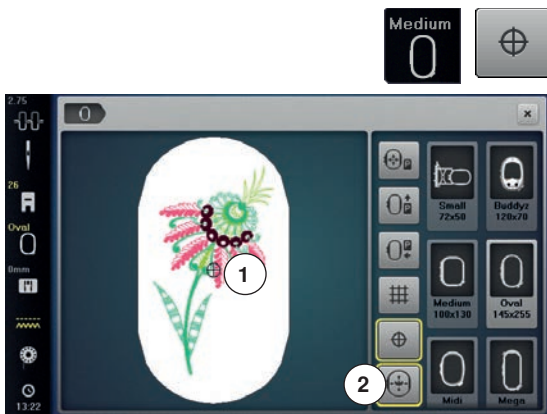

Motif Center

- touch the «Select hoop»-icon
- touch the «Motif center»-icon
 - ▶ center of motif **1** is shown in the the Display
 - ▶ the hoop is moved until the needle is exactly in the center of the motif, when the function «Virtual Positioning» **2** is activated
- touch the «Motif center»-icon again
 - ▶ the first stitch of the motif will be marked again in the Display

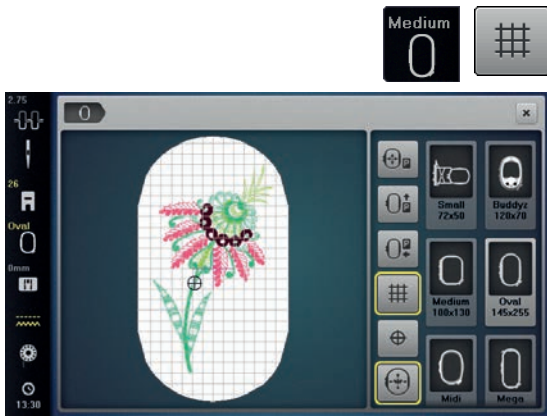

Grid

- touch the «Select hoop»-icon
- touch the «Grid»-icon
 - ▶ a big cursor indicates the center of the hoop
- touch the «Grid»-icon again
 - ▶ due to the visual grid, which appears in the display, embroidery motifs can be positioned easily
- touch the «Grid»-icon again
 - ▶ the grid disappears

Absolute Embroidery check

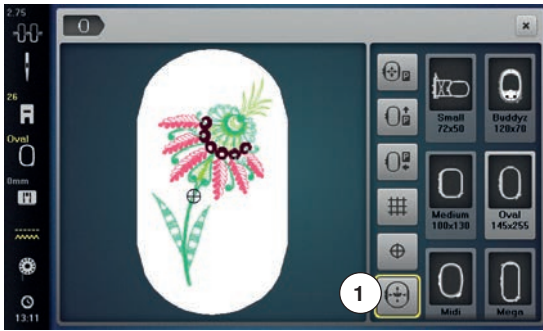

By using the Touchscreen pen or finger, any position within the motif can be selected directly in the «Edit»-screen.

- select and edit motif
- attach the respective hoop

The «Motif center»-icon must be deactivated in order to apply the Absolute check.

- check the motif within the hoop by using the Touchscreen pen
- select any point in the motif with the Touchscreen pen
- ▶ the cursor (marking the needle position) moves to the selected area
- ▶ if the icon «Virtual positioning» 1 is activated (yellow-framed), the hoop is moved to position the needle over the selected area



If the thread breaks, place the Touchscreen pen on the area of the Display where the thread broke and the hoop moves to that area.



Checking the motif size

The «Check motif size»-function reads the attached hoop size and stitching area:

- touch the «i»-icon
- touch the «check»-icon
- select the four corners using the arrow icons
- touch the «Motif center»-icon
- ▶ the needle moves to the center position of the motif
- turn the stitch width knob to the left or to the right
- ▶ the motif is moved horizontally
- turn the stitch length knob to the left or to the right
- ▶ the motif is moved vertically



Zoom



- touch the «Zoom+»-icon 1-5x

▶ the view of the motif is enlarged by one step

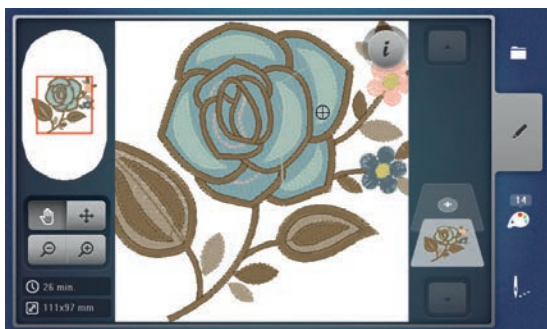

- touch the «Zoom-»-icon 1-5x
- ▶ the enlarged view of the motif is scaled-down by one step



Moving the motif

- touch the «Move»-icon

• the position of the motif can be moved to any direction in the Display using finger, the Touchscreen pen or the knobs

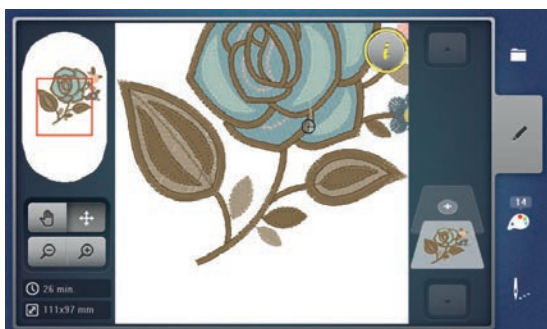

Motif size and embroidery time

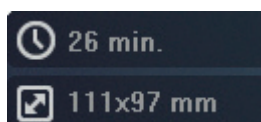

The «Edit»-Display at the bottom left shows the embroidery time in minutes, width and height of the motif are displayed in mm.

Endless Embroidery

When embroidering a border, it is advantageous to use the Mega or Jumbo Hoop. The fabric requires less rehooping than with the Oval Hoop. We recommend marking reference lines on the fabric, and using the template when hooping and rehooping. Here, the reference lines must run parallel to the lines on the template.



- select the desired motif
- touch the «i»-icon
- touch the «Endless embroidery»-icon 1



- ▶ the embroidery motif is duplicated as many times as possible to fill the hoop
- ▶ the reference points - necessary for placement when rehooping the fabric - are also stitched out
- the arrow buttons may be used to add additional reference points in different directions



Increase/decrease number of motifs

- via the stitch width knob or the «+» or «-»-icons the number of motifs can be increased or reduced
- touch the field in the center
- ▶ back to starting position



Increase/decrease spacing

- via the stitch length knob or the «+» or «-»-icons the distance between the motifs can be altered
- ▶ Display is in mm
- touch the field in the center
- ▶ back to starting position



Fit to hoop

- ▶ should more motifs be entered manually than will fit in the hoop, the hoop appears in red
- ▶ use the «Fit to hoop»-function to automatically adjust the size of the motifs so they all fit in the hoop
- touch the field in the center
- ▶ back to starting position

Motifs



- touch ✓ to confirm
- ▶ the «Edit»-Display appears
- touch the «i»-icon
- ▶ the function overview closes
- change to the Embroidery Display and embroider the border



In the embroidery menu it's possible to change the embroidery speed.



- after the reference points are stitched, touch the «Endless embroidery»-icon



- ▶ an animation shows how to rehoop the material
- rehoop the material so that the embroidered reference points are in the upper part of the embroidery area in the hoop
- when rehooping, make sure that the reference points do not lie too near the edge of the hoop, or they will be out of the stitching area (at least 3 cm from the top edge of the hoop)
- attach the hoop
- touch ✓

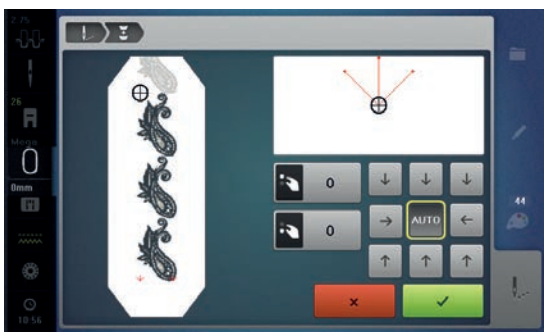

- ▶ the hoop is moved near the last stitch
- using the stitch width and/or the stitch length knob, move the hoop until the needle is over the last stitch
- touch ✓ to change to the Embroidery Display and resume embroidering
- repeat these steps until the border is the desired length
- ▶ «Auto» is active, the hoop moves automatically to the last reference point
- the arrow buttons can be used to specify on which side of the embroidered section the next one is to be joined
- hoop the material accordingly
- touch ✓ to change to the Embroidery Display and resume embroidering

Free arm embroidering

Free arm embroidering is defined as embroidering tubular fabrics or garments which are positioned around the free arm of the embroidery machine while being embroidered. Often used with sleeves, pant legs or other narrow-tailored garments.



A tubular piece of fabric can be pulled over the free arm of the machine easily when the free arm is positioned to the left in parking position before the hoop is attached or removed. Push the button «Start/Stop» to move the embroidery hoop back to the embroidery position again.

Make sure to use a full bobbin as the embroidery hoop needs to be removed for changing the bobbin.

Borders can be closed to a ring easily and exactly along the edge of the tube. Before embroidering the last embroidery motif, after rehooping the fabric, activate the function «Pinpoint placement» in the edit mode. Using the subfunction «Free point positioning» align the still missing embroidery motif precisely.

The movability of the embroidery arm can be limited or impeded with very narrow tubes. Therefore please make sure that the embroidery hoop can move forwards and backwards sufficiently. An impediment of the embroidery arm caused by a tube which is too tight can result in embroidery motif offset or in damaging the fabric.

Check the movability of the free arm

Please note: With a narrow fabric tube, deactivate the thread removal in the Setup Program if necessary.

- open the embroidery motif on the machine and edit as desired
- mark the embroidery motif position and the size on the fabric in a suitable way
- select the embroidery hoop as small as possible
- hoop or stick the fabric along with the appropriate stabilizer in the embroidery hoop, depending on the stabilizer
- pull the fabric tube carefully over the free arm of the machine and attach the embroidery hoop at the clutch of the embroidery module
- if necessary, reposition the embroidery motif
- previously check whether the embroidery hoop can be moved forwards and backwards according to the embroidery motif size
- touch the icon «Check embroidery motif size»
- after the successful check of the embroidery motif size, start the embroidery process



Detailed instructions about embroidery, the use of suitable materials or selecting the required embroidery settings of the machine can be found in the «Tutorial» under embroidery techniques --> Embroidering.

Shape designer

Motifs can be arranged in different default formations. The embroidery motif can be placed anywhere with the finger or the Touchscreen pen.



- select the desired embroidery motif
- select the desired hoop
- touch the «i»-icon
- touch the «Shape designer»-icon 1

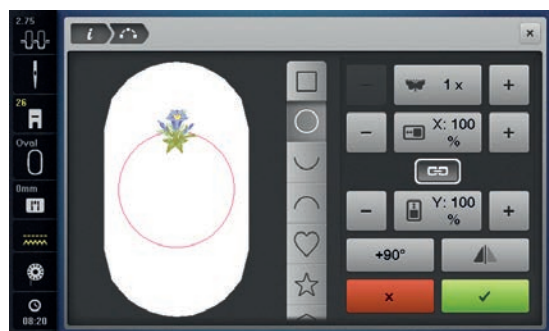

Selecting the formation

Different formation shapes are available. By scrolling more shapes become visible. The rectangular formation is active by default.

- select the desired formation, e.g. circular formation
- ▶ the motif is positioned on the circle line at the top in the center

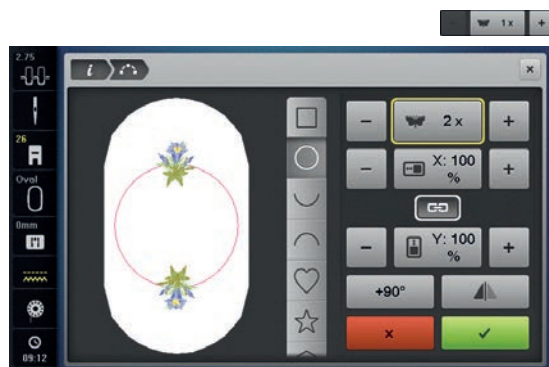

Increasing/reducing the number of motifs

- touch the «+»/«-»-icon with the finger or the Touchscreen pen or
- turn the stitch width knob to the left or to the right
- ▶ the number of motifs is increased/reduced
- touch the yellow-framed icon in the center
- ▶ the basic setting is reset

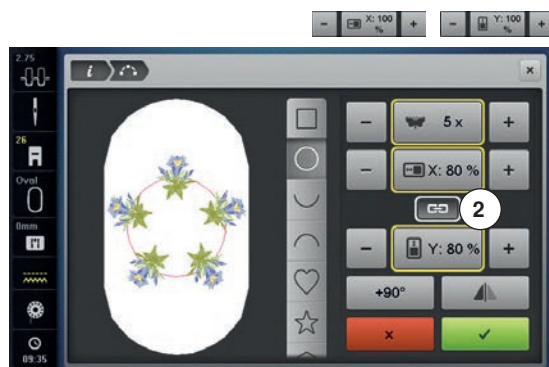

Altering the size of the formation shape

- touch the «+»/«-»-icons with the finger or the Touchscreen pen
- ▶ when icon 2 is activated, the size of the formation is enlarged/scaled down proportionally
- touch the yellow-framed icon in the center
- ▶ the basic setting is reset

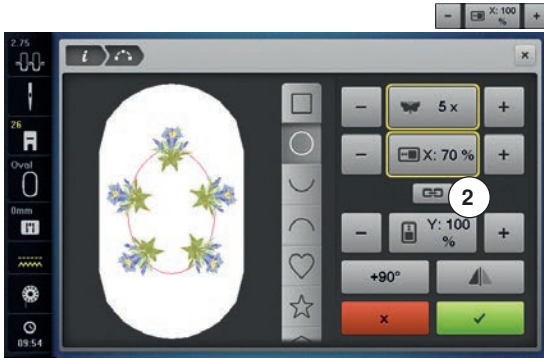

Icon 2 must be deactivated.

- touch the «+»/«-»-icon with the finger or the Touchscreen pen
- ▶ the size of the formation is enlarged/scaled-down horizontally
- touch the yellow-framed icon in the center
- ▶ the basic setting is reset

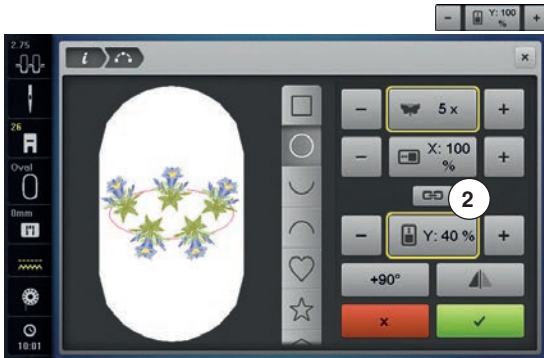

Icon 2 must be deactivated.

- touch the «+»/«-»-icon with the finger or the Touchscreen pen
- ▶ the size of the formation is enlarged/scaled-down vertically
- touch the yellow-framed icon in the center
- ▶ basic setting is reset

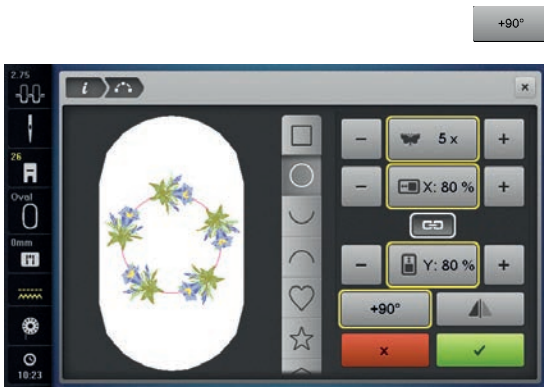

Rotating the motifs

- touch the «+90°»-icon with the finger or the Touchscreen pen
- ▶ the motifs are rotated clockwise in 90° increments



Mirroring motifs

- touch the «Mirror Image left/right»-icon with the finger or the Touchscreen pen
- ▶ every second motif will be mirrored horizontally
- touch the yellow-framed icon
- ▶ basic setting is reset



Embroidering the motifs

- touch ✓ to confirm the created motif
- ▶ the «Edit»-Display appears
- touch the «i»-icon
- ▶ the function overview closes
- change to the embroidery Display and embroider the motif



Closing the «Shape designer»-Display

When the «Shape designer»-Display is closed via ✗, the created embroidery motif won't be visible in the «Edit»-Display and cannot be embroidered.

Combinations

Creating combinations

As combinations are created, layers appear to the right of the hoop. They show the order of the motif as it is created. The layers can be used to select motifs for editing. Deleting is also possible from the layers, by touching and holding and moving to the right/left.



- select the desired motif from the selection menu of the embroidery computer

▶ the motif 1 appears in the «Edit»-Display

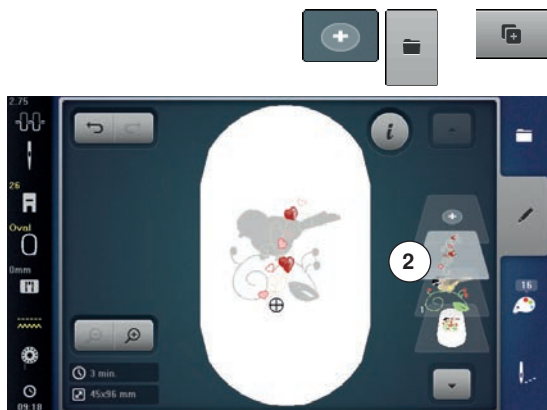

Adding a motif

- touch the «Add embroidery motif»-icon or
- press the «Selection»-button
- touch the «Add motif»-icon
- select the desired motif or alphabet character from the selection menu
- ▶ the selected motif 2 is added



Duplicating a motif

- touch the «i»-icon
- touch the «Duplicate motif»-icon
- ▶ the active motif 3 is duplicated 4

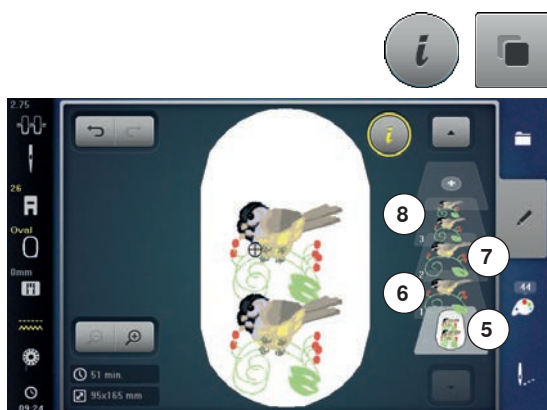

Duplicating a combination

- activate a combination 5
- ▶ touch the «i»-icon
- touch the «Duplicate motif»-icon
- ▶ the active combination 6+7 is duplicated 8

Within in a duplicated combination the single motifs cannot be selected individually, contrary to the initial combination.

Lettering

Lettering (e.g. words) can be combined with other alphabet characters or motifs. The words (e.g. Made to create) can be combined individually and/or positioned individually.



Combining

- touch the «Alphabet»-icon
 - ▶ various alphabet types are visible in the Display
 - touch the desired «Alphabet»-icon
 - ▶ the Display with the keyboard appears
 - e.g. enter Made to
- Select the characters using the «Lower/Upper Case»-icon.
- place the space bar under the keyboard
 - touch ✓ to confirm the combined characters
 - ▶ the lettering appears in the «Edit»-Display



Positioning

- touch the «Select hoop»-icon
- select medium hoop
- touch the «Select hoop»-icon again
- touch the «i»-icon
- touch the «Rotate motif»-icon
- touch the «+90°»-icon
- ▶ the text is rotated by 90°
- touch the «i»-icon above the function Display
- ▶ the function overview appears again
- touch the «Move motif»-icon
- position the text in the Display using the knobs, the Touchscreen pen or the finger

The outline of the hoop is highlighted in red if a stitch of the motif is positioned outside the embroidery area.



Further text lines

- touch the «Add embroidery motif»-icon or
 - press the «Selection»-button
 - touch the «Add motif»-icon
- Combine and position individually the rest of the text.
- touch the «Select hoop»-icon
 - activate the grid, see page 184
 - ▶ use the grid lines to easily and accurately position lines of text

Lettering and Embroidery motifs

Depending on the application, the characters are added after an embroidery motif is selected or the characters are combined first and then added to the motif (e.g. embellished lettering).



Combining

- select the desired embroidery motif
- ▶ the motif appears in the «Edit»-Display
- press the «Selection»-button
- touch the «Add motif»-icon
- touch the dark «Embroidery computer»-icon at the top of the Display
- ▶ selection menu appears
- select the desired alphabet
- ▶ the Display with the keyboard appears
- enter text, e.g. Flowers

Select the characters using the «Lower/Upper Case»-icon.

- touch ✓ to confirm the combined characters
- ▶ the text appears above the motif in the «Edit»-Display



Adjusting text to motif

- touch the «i»-icon
- touch the «Rescale motif»-icon
- adjust the text to the motif
- touch the «i»-icon above the function Display
- touch the «Move motif»-icon
- position the text as desired



Lettering Manipulation

- touch the «i»-icon
- touch the «Letter manipulation»-icon
- turn the stitch length knob to the left
- ▶ the lettering is bent upwards



Deleting stitch patterns/individual characters/text

Single parts of combinations which have not been saved yet can be deleted as follows:

- select the part of the combination to be deleted
- touch the «i»-icon
- touch the «Delete»-icon
- touch ✓ to confirm or
- select the part of the combination from the layers to be deleted using the finger, keep it pressed and move to the right or left
- remove the finger from the Display
- touch ✓ to confirm
- ▶ the selected part is deleted

Change stitch type



- touch the «i»-icon
- touch the «Change stitch type»-icon

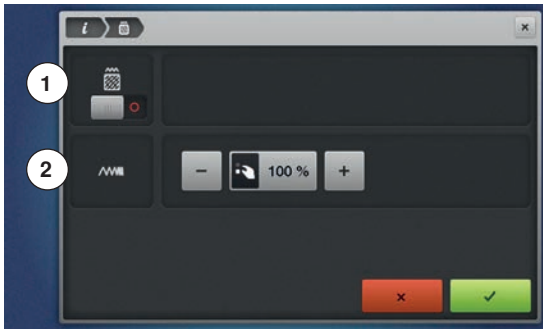

- 1 Altering stitch type.
- 2 Altering stitch density.



- touch the «Change stitch type»-icon
- ▶ the basic setting of the step stitch is activated



If the motif is enlarged substantially, long satin stitches occur, tunneling the fabric. In this case, it is recommended to switch to the step stitch fill.

Fill stitch types

The embroidery motifs are filled with satin or step stitches.



Satin stitch

The needle moves left to right and vice versa.



Step stitch (Fill stitch)

The needle stitches in straight rows at regular intervals.



- touch the «Change stitch type»-icon



Changing stitch type

The satin stitch fill changes to a maximum of 8 mm long step stitches fill (basic setting).

- ▶ touch the «+»/«-»-icon or turn stitch width knob to the left or to the right
- ▶ maximum step stitch length is increased/decreased

The maximal step stitch length is 12.7 mm and the minimal length 0.5 mm.

- touch ✓ to confirm
- chosen step stitch length is saved and the «Edit»-Display appears



Back to basic settings

- touch the yellow-framed icon
- ▶ the basic setting (8 mm) is activated

Back to satin stitch

- touch the «Change stitch type»-icon again
- ▶ the motif is filled with satin stitches again



Altering stitch density

- touch the «+»/«-»-icon or turn stitch length knob to the left or to the right
- ▶ the stitch density is increased (more stitches)/decreased (less stitches)

The maximum stitch density is 300% and the minimum 25%.

- touch ✓ to confirm
- ▶ chosen stitch density is saved and «Edit»-Display appears

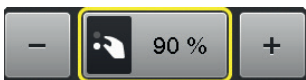

Back to basic settings

- touch the yellow-framed icon
- ▶ the basic setting (100%) of the motif is activated again

Motif colors



Reallocating motif colors

- touch the «Color number»-icon in the Display
- scroll with the arrow icons, if necessary, until the color to be changed appears
- select the color to be changed (e.g. 1)



- touch the «Thread color»-icon
- use the arrow icons beneath the thread colors to scroll until the desired color appears
- select the desired color or
- touch the «0-9»-icon and
- enter the color number via the keyboard
- ▶ the new color is reallocated
- ▶ the altered color is displayed
- touch the «Back»-icon **1**
- ▶ the color overview of the selected embroidery motif appears

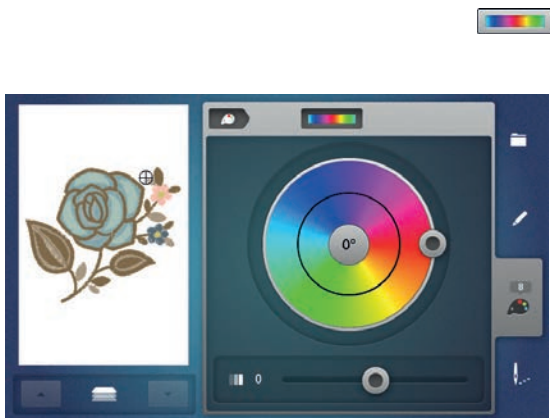

Changing the colors of the motif via the color wheel

- touch the «Color wheel»-icon
- ▶ the «Color wheel»-Display opens

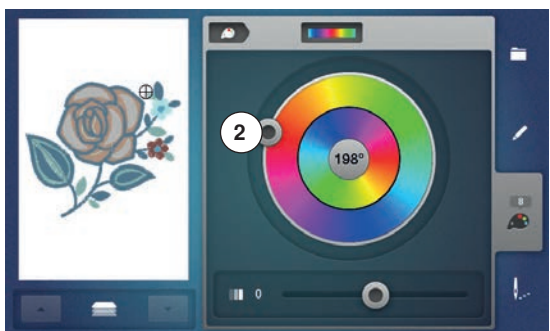

- turn the slider **2** clockwise or counterclockwise using the finger or the Touchscreen pen or
- turn the stitch width knob
- ▶ the colors are changed



Adjusting the brightness of the colors

- move the slider **3** to the left/right using the finger or the Touchscreen pen or
- turn the stitch length knob
- ▶ the brightness of the color gets brighter or darker
- touch the «Back»-icon **4**
- ▶ the changed motif colors are matched with the selected thread brand
- press the «Edit»-button **5**
- ▶ the motif with the new colors is visible in the «Edit»-Display

When the «Color wheel»-Display has been closed and opened again, the color wheel will appear in basic setting.

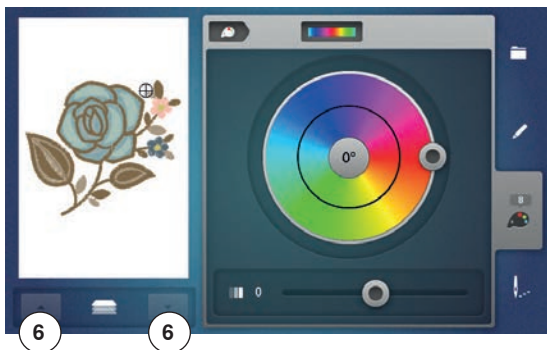

A single motif in a combination can be selected by touching the «up/down»-icons **6** and the colors can be changed using the color wheel.



Changing the thread brand

- touch the «Thread color»-icon
- scroll with the arrow icons left or right until the desired thread brand appears
- touch the «Thread brand»-icon **8**
- ▶ the thread brand in the Display changes and the new thread details appear
- touch the «Back»-icon **7**
- ▶ the altered thread details are displayed



Different thread brands can be assigned to the motif.

- scroll to the desired thread brand
- do **not** touch the «Thread brand»-icon
- scroll to the desired color
- touch the icon



Embroidering the motif by color

- press the «Embroidery menu»-button
- ▶ «Color resequence»-icon is inactive (standard, gray)
- ▶ the colors of a motif are not reduced, the embroidery sequence remains as set originally. The number of color changes **9** remains as it is

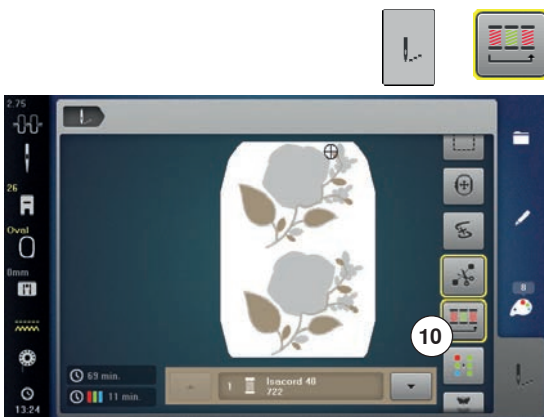

Reducing color changes

- press the «Embroidery menu»-button
- touch the «Color resequence»-icon
- ▶ identical colors are resequenced and combined to form «color blocks». This reduces the number of color changes to a minimum **10**
- ▶ with overlapping embroidery motifs the color change **cannot** be reduced



Embroidering motifs in one color

- press the «Embroidery menu»-button
- touch the «Single/Multi-Color Motif»-icon
- ▶ the function is activated
- ▶ the embroidery computer embroiders the complete motif and stops when finished



Embroidering lettering in multi colors

Lettering is always displayed in one color («Single/Multi-Color Motif»-icon is not available). To embroider each letter of a word or each word of a word combination in a different color, each letter or word must be programmed and placed separately.

- ▶ the embroidery computer stops after each letter or word
- the thread color can be changed
- ▶ the embroidery time for each color is displayed

Embroidering lettering in one color

- touch the now available «Single/Multi-Color Motif»-icon
- ▶ the complete lettering combination is embroidered in one color

Basting



- press the «Embroidery menu»-button
- touch the «Basting»-icon



The embroidery motif is outlined with a basting stitch. This serves as an additional anchoring of the project so that the fabric and stabilizer are adhered.



- touch the «Basting»-icon again
- ▶ the symbol changes



The basting is now embroidered along the hoop.

Deactivating basting

- touch the icon again
- ▶ basting stitches are deactivated

Endless Embroidery



Allows to resume embroidering borders which have already been started even if the machine has been switched off and on again.

Prerequisite: An embroidery motif for borders must be saved in the Personal Memory. The reference points must be defined in the embroidery motif.



- select border embroidery motif from the Personal Memory
- touch the icon «Embroidering»
- the icon «Endless embroidery» becomes visible in the right bar by scrolling upwards
- remove the hoop and rehoop the fabric so that the stitched out reference points are in the upper part of the embroidery area and at least 3 cm (1.18 inch) from the top edge of the hoop
- attach the hoop
- touch the icon «Confirm»
- ▶ the hoop is moved automatically near the last stitch
- ▶ the icon «AUTO» is activated and the hoop moves automatically near the last reference point
- via the arrow icons, determine on which side of the embroidered part the next reference point shall be placed
- turn the «Upper Multifunctional knob» or the «Lower Multifunctional knob» to position the hoop exactly
- touch the icon «Confirm»
- push the button «Start/Stop» and resume embroidering
- repeat these steps until the desired length of the border is embroidered

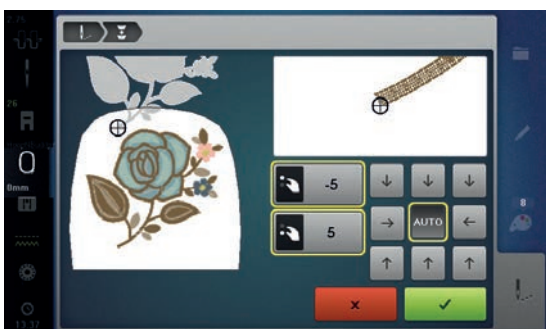

Importing stitch patterns from the sewing mode

Stitch patterns or stitch pattern combinations can be imported from the sewing mode to the embroidery mode and they can be edited like embroidery motifs. Therefore e.g. endless embroidery patterns are combined, duplicated, mirrored etc. quickly and easily. Finally, these combinations can be saved as embroidery motifs in the folder «My Design».



When an imported stitch pattern is not saved in the embroidery mode, it will be overwritten by the next selected the stitch pattern.

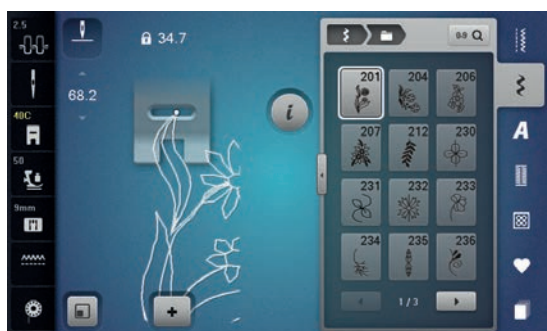

Selecting stitch patterns in the sewing mode

- select the stitch pattern No. 201 in the category 200
- touch the «Home»-button
- touch «Embroidery mode»-icon

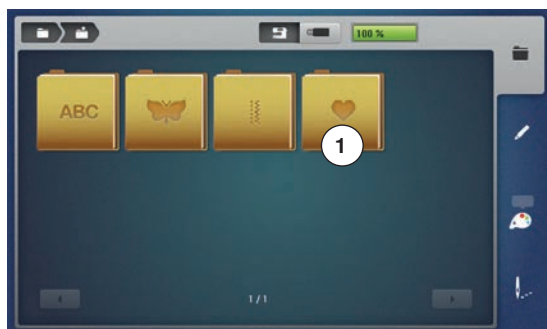

Selecting stitch patterns in the embroidery mode

- touch «My Design»-icon 1

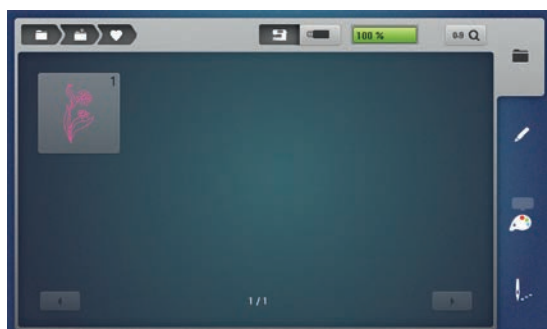

- ▶ the stitch pattern has been imported to the folder «My Design»
- select the stitch pattern

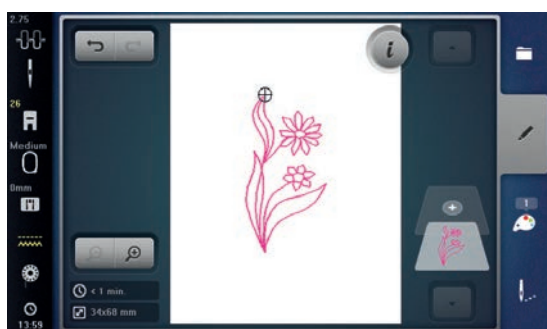

- ▶ the stitch pattern appears in the «Edit»-display
- ▶ the stitch pattern can be edited by any available functions and embroidered like an embroidery motif
- ▶ to remain the stitch pattern in the embroidery mode, it must be saved, see page 202

Saving the motif

Embroidery motifs from the embroidery computer, the USB stick or designs created in the BERNINA Embroidery Software can be altered in different ways, then saved.

Embroidery motifs can either be saved in the embroidery computer memory or on an USB stick.



Embroidery motifs which were altered in size and saved are regarded as new motifs when they are recalled. That is why all percentages say 100%, and the former alteration can no longer be seen.

Memory Embroidery computer

- select the desired motif
- alter if desired
- press the «Selection»-button
- touch the «Save»-icon 1

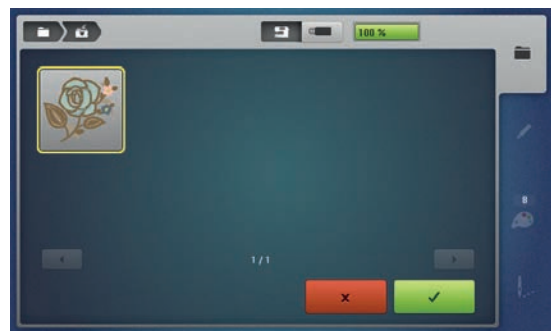
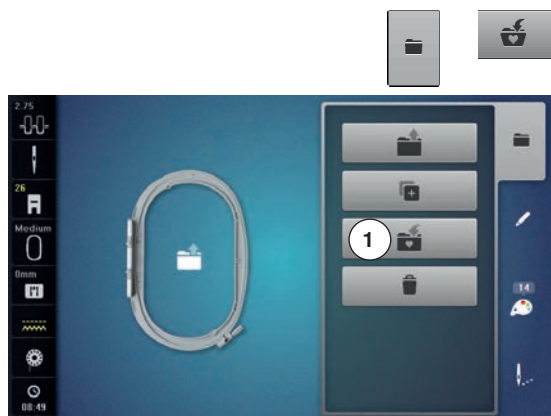

The motif to be saved is displayed in a yellow frame.

- ▶ «Embroidery computer»-icon is active
- ▶ the «My Designs» folder is opened automatically
- ▶ the system memory capacity (free capacity) is displayed in percent (%) in the green bar icon
- select the motif to be saved
- ▶ the embroidery motif is saved in numerical order in the «My Designs» folder
- ▶ the «Edit»-Display appears again

USB stick

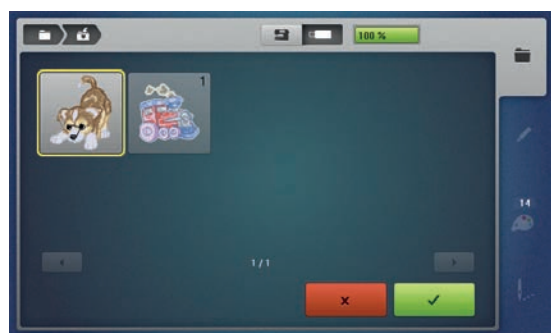

The motif to be stored is displayed in a yellow frame.

- insert the USB stick
- touch the «USB stick»-icon
- ▶ the system memory capacity (free capacity) is displayed in percent (%) in the green bar
- select the motif to be stored
- ▶ the motif is stored on the stick



Empty USB sticks are available as optional accessory at the BERNINA-dealer.
Sticks of other brands are unlikely to be supported, especially sticks providing a large memory capacity.
USB stick must be inserted into the PC and be formatted as FAT 32 before use.

Overwriting motifs

Saved motifs in the memory or on an USB stick can be overwritten directly by another motif.

- select the desired motif



- insert the BERNINA USB stick
- press the «Selection»-button
- touch the «Save»-icon



The motif to be saved is displayed in a yellow frame.

- press the «Embroidery computer»-button or touch the «USB stick»-icon
- select the motif to be overwritten

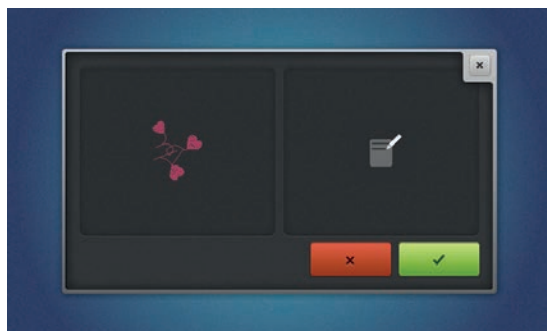

- touch ✓ to confirm
- ▶ the motif is now saved at the previously selected position

Deleting saved single motif



- insert the USB stick
- press the «Selection»-button
- touch the «Delete»-icon
- touch the «USB stick»-icon or
- touch the «Embroidery computer»-icon



- select the motif to be deleted



- touch ✓ to confirm
- ▶ the motif is deleted

Cancelling delete

- touch ✗
- ▶ the deleting is cancelled, the previous screen appears

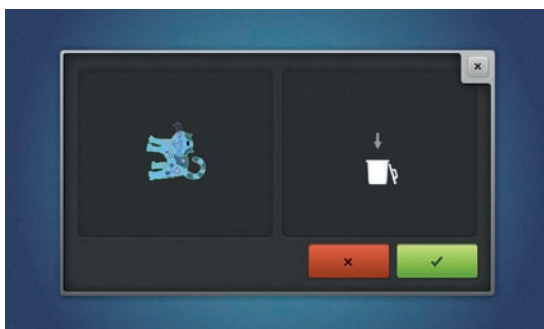

Deleting all saved motifs

It is possible to delete the content of the folder «My Designs» or the Memory Stick all at once.



- press the «Setup»-button
- touch the «Sewing computer settings»-icon
- touch the «Basic settings»-icon

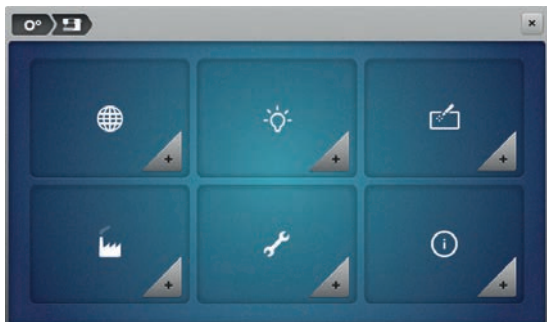

When embroidering there are two options to choose from:

- 1 My Designs
 - 2 USB stick (Stick must be inserted)
- touch the icon of whose data should be deleted

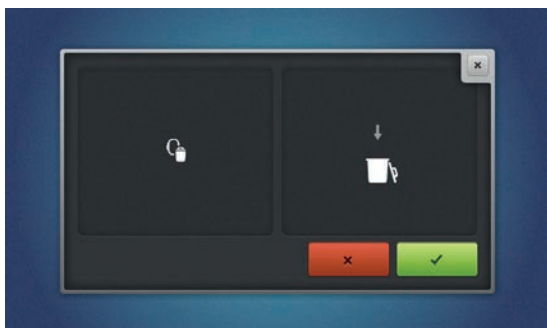

- touch ✓ to confirm
- ▶ the data is deleted

Cancelling delete

- touch ✗
- ▶ the deleting is cancelled, the previous Display appears

Starting to embroider

Select hoop



- select a motif
 - ▶ the selected motif is displayed in the optimal (the smallest) hoop
 - ▶ the «Select hoop»-icon 1 Displays the recommended hoop
- attach the recommended hoop

Attaching the embroidery hoop

- raise needle and embroidery foot
- hold the hoop with the right side of the fabric up and the attaching mechanism to the left

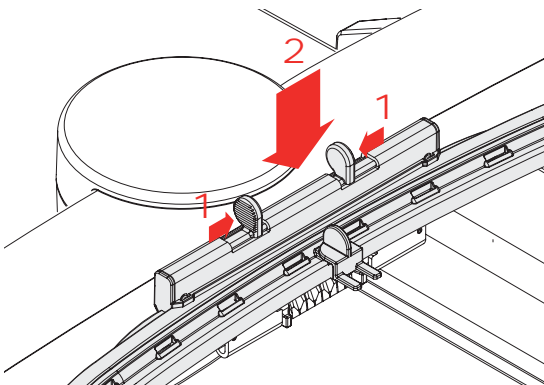

Attaching the hoop to the embroidery arm

- guide the hoop underneath the embroidery foot
- press both of the attaching mechanisms of the hoop toward each other
- position the center points of the hoop (small attachment clamps) over the bracket of the embroidery arm
- press down until it clicks in position
- release the attaching mechanism of the hoop

Removing the hoop

- press both of the attaching mechanisms of the hoop towards each other
- lift the hoop up to remove



- press the «Embroidery menu»-button or the «Start/Stop/hover»-button
 - ▶ the hoop moves
 - ▶ the hoop is read



Calibrating the embroidery hoop see page 57.



As soon the «Embroidery menu»-button has been pressed, motif alterations will not be visible anymore when going back to the «Edit»-Display. The «Information»-icon turns blue again, the function icons are no longer yellow-framed and the setting is at 100%.

Embroidery menu



- ▶ the embroidery menu opens
- ▶ the motif is ready for embroidering

Embroidering using the «Start/Stop/hover»-button



- press the «Start/Stop/hover»-button, until the embroidery computer starts

Interrupting the process

- press the «Start/Stop/hover»-button
- ▶ the embroidery computer stops

Completing the color

- press the «Start/Stop/hover»-button
- ▶ the embroidery computer embroiders all the sections in the color activated
- ▶ the embroidery computer stops automatically when complete
- ▶ both threads are automatically cut

Color change

- ▶ the embroidery computer switches automatically to the next color
- change color of the upper thread accordingly
- embroider with the new color



«Embroidery»-Display

- ▶ after starting the motif the «Embroidery»-Display appears

Embroidery speed

To guarantee the best embroidery quality the speed when embroidering is reduced according to the embroidery position. You have the options to choose from optimal and maximum speed. Standard = optimal.



- touch the «Embroidery speed»-icon
- ▶ the maximum embroidery speed-mode is activated

Please note that the quality of the embroidered motif may not be optimal at maximum speed.



- by touching the «Embroidery speed»-icon again or by switching off or on the embroidery computer, the optimum embroidery speed is activated again

Motifs



End of embroidery

- after completing the motif touch the icon **1** to finish the embroidery process, or touch the «Endless Embroidery»-icon **2** again to repeat the border embroidery

Embroidering via foot control

When embroidering via the foot control always keep it depressed.

- press the foot control

Interrupting the process

- release the foot control
- ▶ the embroidery computer stops

Completing the color

- press the foot control
- ▶ the embroidery computer embroiders all the sections in the color activated
- ▶ the embroidery computer stops automatically when complete
- ▶ both threads are automatically cut

Color change

- ▶ the embroidery computer switches automatically to the next color
- change color of the upper thread accordingly
- embroider with the new color



«Embroidery»-Display

- ▶ after starting the motif the «Embroidery»-Display appears



Embroidering via the foot control is recommended for a small sequence.

Thread breakage when embroidering

The upper or lower thread may occasionally run out or break when you are embroidering. When this happens, the embroidery computer stops automatically, provided that the thread and bobbin indicators are activated in the Setup-Program.

Upper or lower thread breaks



- ▶ the embroidery computer stops automatically
- ▶ an animation is displayed
- check upper thread
- rethread needle
- check lower thread
- refill or rethread bobbin

Embroidery sequence control when thread breaks



- touch the «Embroidery sequence control»-icon



In the left part of the Display the current color of the motif is displayed in normal size and in the right part the view is enlarged. This makes it easier to check the embroidery sequence.

- ▶ the message to operate the stitch width and stitch length knobs appears
- turn the knobs to the left or to the right
- ▶ the hoop moves along the embroidery sequence backwards or forwards
- turn the stitch width knob slowly
- the hoop is moved stitch by stitch
- turn the stitch length knob slowly
- the hoop is moved in big steps
- ▶ the number in the yellow-framed icon indicates the current position within the motif by stitch number
- via the «0-9»-icon a position can be entered directly
- position the needle back far enough so that it will resume stitching several stitches before the thread breakage

Returning to original position

- touch the «Back»-icon 1
- ▶ the Display closes

Resuming embroidery

- press the «Start/Stop/hover»-button or the foot control



The embroidery sequence control is also used for advancing or backing up in PaintWork, CrystalWork and CutworkDesigns.

Cleaning

ATTENTION!

Disconnect plug from the socket before cleaning or lubricating!
Never use alcohol, petrol, white spirit or any type of solvent to clean the sewing computer!

Cleaning the Display and the sewing computer

Wipe with a soft, damp cloth.

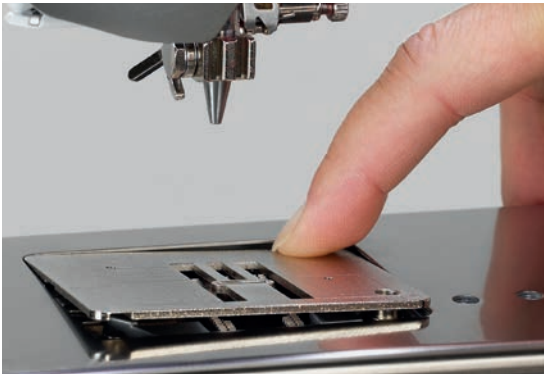

Cleaning the feed dog area and the hook

Clean the sewing computer after every use - remove any lint from under the stitch plate and in the hook area.

- open the bobbin door
- turn power switch to «0» (off)
- remove plug from electrical outlet
- remove presser foot and needle
- press the stitch plate down at the right back corner until it flips up
- remove the stitch plate
- clean the stitch plate and the lower thread indicator using a brush or the vacuum cleaner



- remove the bobbin
- clean the hook and the hook race the with a brush; do not use any pointed objects
- insert the bobbin
- replace the stitch plate
- plug in the power cable to the sewing computer
- turn the power switch to «I»
- close the bobbin cover



Lubricating

- open the bobbin door
- turn the power switch to «0» (off)
- remove the plug from electrical outlet
- removing the bobbin
- hold the bobbin retainer with the left hand and turn the handwheel with the right hand until the hook race can be seen
- apply a minimal amount of BERNINA-oil in the hook race
- insert the bobbin
- plug in the power cable to the sewing computer
- turn the power switch to «I»
- close the bobbin cover
- run the sewing computer at idle for a moment
- ▶ no soiling of the sewing good

ATTENTION!

The battery must be kept out of the reach of children.

Don't use rechargeable batteries.

Don't throw batteries into fire.

Danger of explosion!

Do not throw away batteries with your household waste but dispose of them in an environmental way via the public collection system.

Exchanging the battery

Use 3V batteries, coin cell CR 2032 only.

- tilt the sewing computer backwards carefully

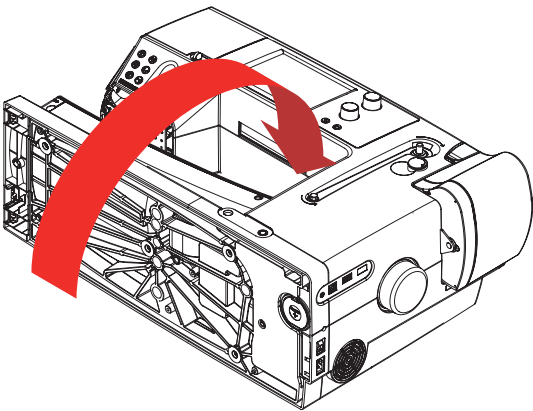

- remove the cover of the battery compartment
- open the latch at the battery using a little screw driver and remove it

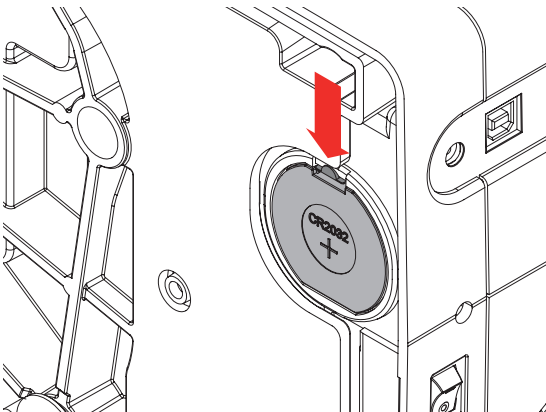

- insert the new battery and press backwards until the latch engages
- close the battery compartment

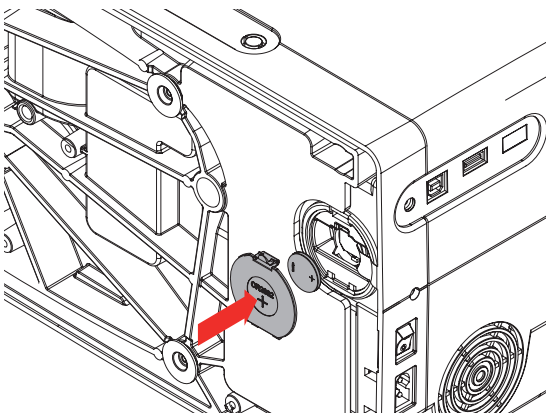

Troubleshooting

In most cases you will be able to identify and remedy faults by checking the following.



Various troubles can be eliminated by turning the sewing-/ embroidery computer off and turning it on again after 10 sec.

Check if:

- the upper and lower threads are threaded correctly
- the needle is inserted correctly
- the needle size is correct - check the needle/thread table page 17
- the needle tip and shaft are undamaged
- the sewing computer is clean - brush out any thread lint
- the hook race is clean
- any threads are trapped between the tension discs or under the bobbin case spring

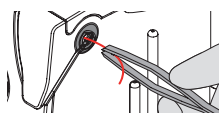
Fault	Cause	Repair
Uneven stitch formation	<ul style="list-style-type: none"> – lower thread incorrectly threaded – upper thread incorrectly threaded – needle blunt or bent – poor quality needle – upper thread too tight/too slack – poor quality thread – needle/thread combination is incorrect – lower thread too tight/too slack 	<ul style="list-style-type: none"> • check the threading path of the lower thread • check the threading path of the upper thread • use new BERNINA quality needle • use new BERNINA quality needle • reduce/increase upper thread tension • use quality thread (Isacord, Mettler, Gütermann etc.) • match the needle to the thread size • reduce/increase lower thread tension
Skipped stitches	<ul style="list-style-type: none"> – incorrect needle system – needle bent or blunt – poor quality needle – needle/thread combination is incorrect – needle inserted incorrectly – incorrect needle point 	<ul style="list-style-type: none"> • use needle system 130/705H • use new BERNINA quality needle • use new BERNINA quality needle • match the needle to the thread size, refer to page 17 • insert needle as far up as it will go • match the needle point to the texture of the material
Upper thread breaks	 <ul style="list-style-type: none"> – needle/thread combination is incorrect – upper thread tension too tight – incorrectly threaded – poor quality or old thread – stitch plate or hook tip damaged 	<ul style="list-style-type: none"> • match the needle to the thread size • reduce the upper thread tension • check the threading path of the upper thread • use quality thread (Isacord, Mettler, Gütermann etc.) • take the sewing computer to the nearest authorized BERNINA dealer • remove thread remnants at the pre-tension carefully using tweezers and check the thread lever if necessary, refer to page 213
Lower thread breaks	<ul style="list-style-type: none"> – lower thread tension too tight – stitch hole in the stitch plate has been damaged – needle blunt or bent 	<ul style="list-style-type: none"> • reduce the lower thread tension • take the sewing computer to the nearest authorized BERNINA dealer • use new BERNINA quality needle
Needle breaks	<ul style="list-style-type: none"> – needle not correctly inserted – fabric was pulled – fabric was pushed when using thick material – poor quality thread with knots 	<ul style="list-style-type: none"> • tighten the needle clamp screw • do not pull the fabric during sewing • use the correct presser foot for thick material (e.g. Jeans foot No. 8) use height compensating tool when sewing over a thick seam • use quality thread (Isacord, Mettler, Gütermann etc.)
Faulty stitching	<ul style="list-style-type: none"> – thread remnants between between the tension discs of the upper thread tension – incorrectly threaded 	<ul style="list-style-type: none"> • fold a piece of thin material and slide the folded edge (not the raw edges) between the thread tension discs, moving the material sideways over the front and back of the thread tension disc • check upper and lower thread

Fault	Cause	Repair
Display is inactive	<ul style="list-style-type: none"> – calibration data incorrect – eco-function active 	<ul style="list-style-type: none"> • re-calibrate the Display in the Setup-Program • turn off eco function
Stitch width not adjustable	<ul style="list-style-type: none"> – setting activated in the security program 	<ul style="list-style-type: none"> • deactivate setting
Sewing-/embroidery computer	<ul style="list-style-type: none"> – sewing-/embroidery computer fails to run or runs slowly – the sewing-/embroidery computer was kept in a cold room – turn the power switch to «0» 	<ul style="list-style-type: none"> • check the setting in the Setup-Program • alter the speed control • place the sewing-/embroidery computer in a warm room one hour before use • turn the power switch to «I» • take the sewing-/embroidery computer to the nearest authorized BERNINA dealer
LED at the buttons aren't on	<ul style="list-style-type: none"> – LED defective – eco-function active 	<ul style="list-style-type: none"> • take the sewing-/embroidery computer to the nearest authorized BERNINA dealer • turn off eco function
LED sewing light and free-arm light do not light up	<ul style="list-style-type: none"> – LED defective – eco-function active – deactivated in the Setup-Program 	<ul style="list-style-type: none"> • take the sewing-/embroidery computer to the nearest authorized BERNINA dealer • turn off eco function • activate in the Setup-Program
Attached presser foot hasn't been recognised	<ul style="list-style-type: none"> – lenses soiled (presser foot, sewing computer) 	<ul style="list-style-type: none"> • clean the lenses periodically using a soft damp cloth
Upper thread indicator does not respond	<ul style="list-style-type: none"> – not activated in the Setup-Program 	<ul style="list-style-type: none"> • activate in the Setup-Program
Lower thread indicator does not respond	<ul style="list-style-type: none"> – bobbin damaged/defective – not activated in the Setup-Program – defekctive sensors 	<ul style="list-style-type: none"> • check the bobbin and exchange if necessary • activate in the Setup-Program • take the sewing-/embroidery computer to the nearest authorized BERNINA dealer
Update error	<ul style="list-style-type: none"> – USB stick is not recognized – Update process is blocked (hourglass stays on Display) – Update-data aren't identified 	<ul style="list-style-type: none"> • use a BERNINA USB stick • remove the stick and turn the sewing computer off and on again. Proceed with the update as indicated by the message • don't save update-data in a folder • unzip update-data

Thread is caught in the area of the take-up lever

- upper thread breaks
- the upper thread has sprang back invisibly into the sewing computer and has wound around the thread lever

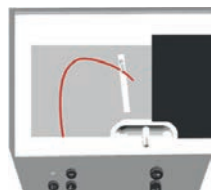
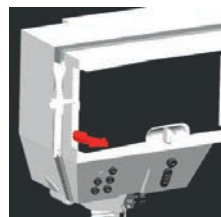

- cut the thread at the thread spool
- Remove the cover on the left of the Display as follows:
- using the left hand, insert the multifunction tool into the slot on the left side of the cover and press onto the latch.
 - simultaneously remove the cover towards you using the right hand
 - remove any thread remnants from the thread lever/regulator carefully with tweezers
 - attach the cover and push backwards until it engages

Fault	Cause	Repair
Automatic threading not possible	<ul style="list-style-type: none"> – limit for double needle is activated – sensor defective 	<ul style="list-style-type: none"> • deactivate the limit for the double needle in the security program • take the sewing-/embroidery computer to the nearest authorized BERNINA dealer
Saving data on USB stick is not possible	<ul style="list-style-type: none"> – the USB stick is not or incorrectly formatted – not enough memory capacity 	<ul style="list-style-type: none"> • insert the USB stick into the PC and format as FAT 32 • delete data

General Messages	Explanation	Repair
	– stitch number not known in direct entry	• check command entered and enter a new number
	– stitch selection not possible in the combination mode	• make another selection
	– incorrect needle for the stitch plate selected	• check settings in securing programs
	– needle is not in the highest position	• turn the handwheel
	– upper thread run out	• attach new upper thread spool and thread
	– lower thread indicator has reacted	• check lower thread and wind if necessary
	– main motor is not running	• remove any thread remnants in the hook area, also refer to «Hook blocked», page 218
	– incorrect presser foot for BERNINA Dual Feed switched on	• attach a «D» presser foot

General Messages

Explanation

Repair

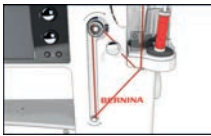

– winding a bobbin

• wind bobbin as shown in the animations



– too much fabric under presser foot

• reduce amount of fabric under presser foot

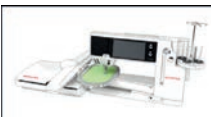

– contact between embroidery computer and embroidery module is interrupted due to vibrations

• reconnect embroidery module and switch off and on the embroidery computer



– needle position doesn't correspond to center of hoop

• calibrate according to User Instructions page 57



– bobbin is inserted incorrectly

• turn over the bobbin, white markings must be visible



– bobbin cover is not closed

• close the bobbin cover slowly



– no bobbin is inserted

• insert the bobbin



– threader does not move to starting position

• push the threader carefully to the top

General Messages

Explanation

Repair



– the button of the automatic thread cutter has been pressed and the needle is blocked at the bottom

- turn the sewing-/embroidery computer off
- turn the handwheel clockwise until the needle is at highest position
- remove the stitch plate
- remove thread remnants
- attach the stitch plate and turn the sewing-/embroidery computer on



– loop formation while sewing

- adjust the thread tension in the thread tension Display

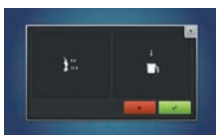

– deleting or overwriting data

- touch to confirm or touch to cancel

Thread jam in the hook with the needle down

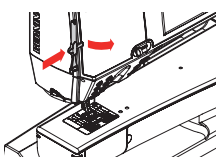

– the thread has been caught in the hook area

- Remove the cover on the left of the Display as follows:
- using the left hand, insert the multifunctional tool into the slot on the left side of the cover and press onto the latch
 - simultaneously remove the cover towards you with the right hand
 - disengage the needle bar using the multifunctional tool
 - remove the needle
 - attach the cover and push backwards until it engages
 - for further proceeding please refer to «Hook jammed»

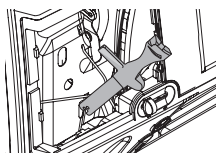

General Messages

Explanation

Repair

Hook jams



– thread nest in the hook system

Various error cases are possible. They are displayed in accompanying messages.

Consistent method as follows:

Step 1:

When the needle is not at its highest position,

- raise the needle by turning the handwheel counterclockwise
- if impossible: cut the upper thread, remove the service lid, disengage the needle bar using the multifunctional tool and raise the needle. Also refer to «Thread jam in the hook with needle down», see page 216

Step 2:

- raise the presser foot

Step 3:

- cut the upper and the lower thread above the stitch plate with scissors

Step 4:

- when the bobbin cover hasn't been opened yet, then open it
- ▶ a message appears «Manual mode for troubleshooting» offering instruction steps

Step 5:

- unplug the foot control

Step 6:

- remove the needle

Step 7:

- swivel out the hook manually by turning the handwheel clockwise

Step 8:

- try to turn the handwheel clockwise until the blockade unwinds. If necessary make use of considerable up to large force
- if not possible: contact the nearest BERNINA dealer

Step 9:

- remove the bobbin and, if necessary, cut the thread

Step 10:

- remove thread remnants carefully with the tweezers. If the threads jam, keep turning the handwheel clockwise slowly and pull the threads out as soon as they come loose

Step 11:

- bring the hook into the illustrated position (see picture on the left) by turning the handwheel clockwise to thread correctly

Step 12:

- insert the bobbin

Step 13:

- check the setting of the lower thread tension

Step 14:

- swivel in the hook **completely** by turning the handwheel counterclockwise and close the bobbin cover

Step 15:

- check the needle and insert it again if it's OK

Step 16:

- plug in the foot control

Step 17:

- quit the messages «Manual mode for troubleshooting» and «Main motor is not running» or «Check hook»



General Messages

Explanation

Repair

Hook blocked



DANGER!

This tool is supposed to be used for the described application only!

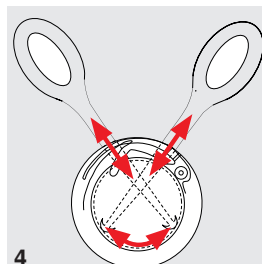
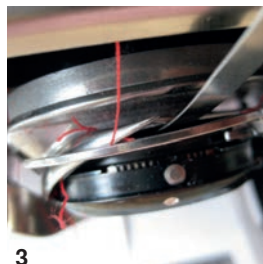
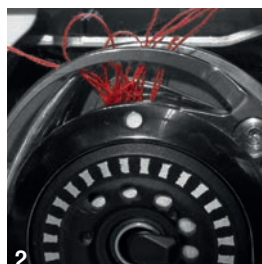
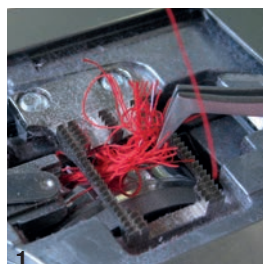

- cut the threads at the stitch plate and remove the sewing good
- remove the presser foot, the needle and the stitch plate
- open the bobbin cover, the hook swivels out
- switch off the sewing computer

- first remove the visible threads in the complete hook area carefully using the tweezers of the standard accessory (Abb. 1)
- hold the bobbin retainer with the left hand (refer to page 31) bring the hook into the illustrated position (Abb. 2) by turning the handwheel
- insert the tool carefully into the opening and pull the threads upwards in lateral and upward movements (ill. 3-4)
- when any threads are removed, oil the sewing computer, turn it on again and close the bobbin cover. The hook must position itself automatically.



– the sewing-/embroidery computer needs lubricating

When this message appears, the sewing computer needs cleaning/lubricating. This ensures the proper functioning and a long durability of the sewing computer.



After lubricating, bring the hook into the illustrated position (see picture on the left) by turning the handwheel clockwise to be threaded correctly.

General Messages

Explanation

Repair



– maintaining the sewing-/embroidery computer

- open the bobbin cover and remove the bobbin
- turn sewing-/embroidery computer off
- remove presser foot, needle and stitch plate
- clean the sewing-/embroidery computer as instructed

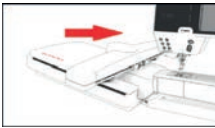

– embroidery module has not been attached yet
– embroidery module has not been correctly attached

- connect the embroidery module to the sewing computer
- check the embroidery module connection



– no embroidery hoop attached

- attach the hoop



– embroidery hoop attached

- remove the hoop

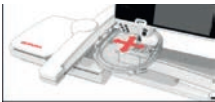

– the hoop moves

- touch to confirm

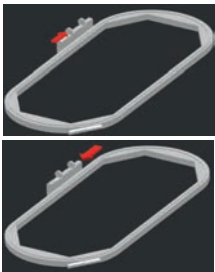

– the embroidery process cannot proceed

- move Mega-Hoop to center position and resume embroidering



– embroidery motif is partly outside the hoop

- reposition the motif. The area within the hoop can be embroidered



– embroidery motif is too large

- reduce the motif size or attach a bigger hoop. The area within the hoop can be embroidered

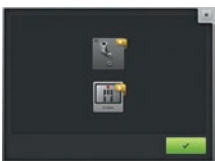

– embroidering cannot be started

- the recommended foot/the recommended stitch plate or an adequate alternative has to be selected

Not enough free memory capacity on the BERNINA memory stick.

– less free space on the USB stick

- delete data from USB stick

General Messages	Explanation	Repair
No personal data on the memory stick.	– no personal data available on the USB stick	• check whether the correct USB stick is inserted and re-start the sewing computer
The recovery of personal data was unsuccessful.	– during the update process personal data was not saved on the USB stick	• the software was correctly updated. Personal data could not be recovered
Please insert the BERNINA memory stick. Make sure the same memory stick is inserted throughout the whole automatic software update process.	– BERNINA USB stick is not inserted	• insert BERNINA USB stick and do not remove during the update process
The software update was unsuccessful.	– the new software version is not available on the USB stick	• save the new software version on the BERNINA USB stick and start the update again
Congratulations! The automatic software update was successfully completed. We wish you many hours of enjoyment with your new BERNINA.	– update successful	• the sewing-/embroidery computer has been provided with the latest software version
It's time for your regular service. Please contact your BERNINA dealer for an appointment!	– it is time for the regular maintenance. Please contact your BERNINA dealer or your BERNINA service address	• the sewing-/embroidery computer must be taken to an authorised BERNINA dealer/servicing shop. The announcement appears after completing the programmed service interval. The message can be deleted temporarily by touching the field X but will reappear when the sewing-/embroidery computer is next restarted. Having cleared the announcement via the X three times, the announcement will appear as recently as the next service interval has been completed. Having your sewing-/embroidery computer cleaned and serviced properly at the appropriate times ensures its proper functioning and long service life. Failure to do so may adversely affect service life and limit the guarantee. The charge for servicing is nationally regulated – consult your dealer or servicing shop for details
Fatal Error	– the sewing computer keeps restarting	• please contact your specialized BERNINA dealer

Overview Stitch patterns

Practical stitches

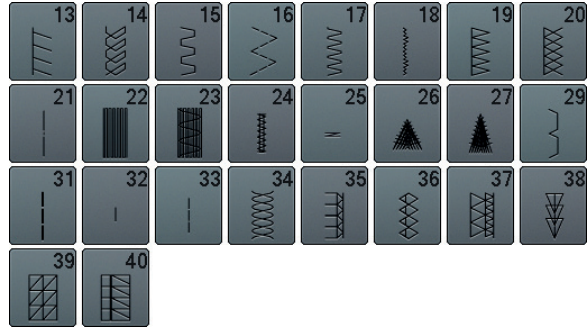
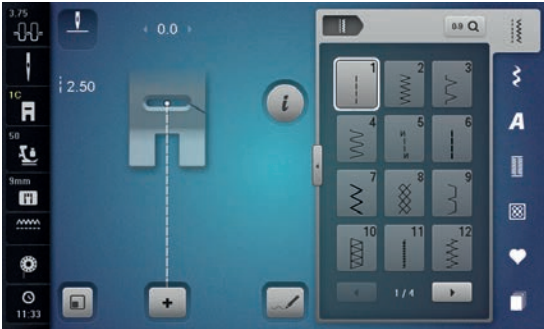

Buttonholes

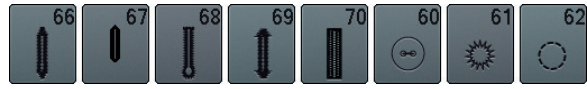
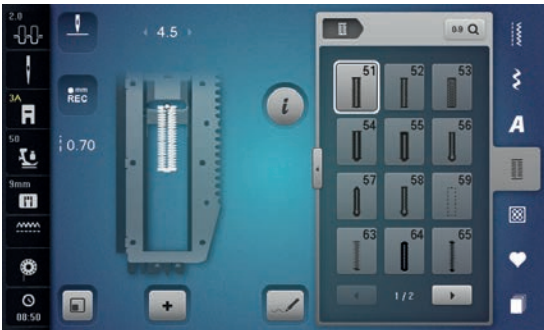

Decorative stitches Florals



Stitch patterns

Florals Sideways Motion



Cross stitches

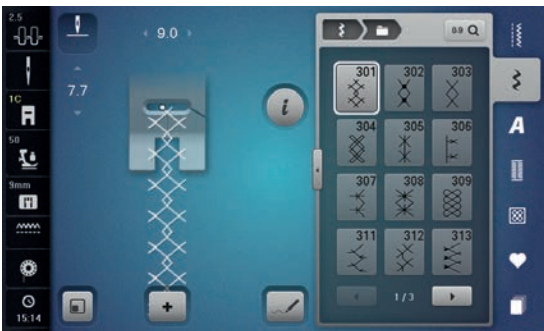

Satin stitches



Satin Stitches Sideways Motion



Ornamental stitches

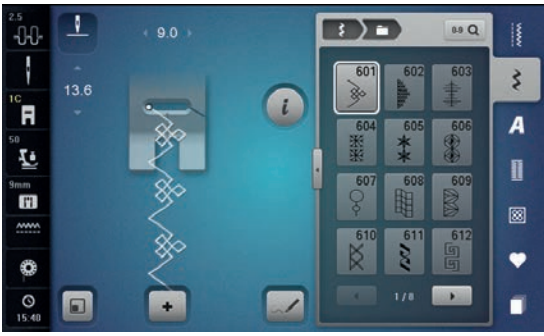

Heirloom stitches



Stitch patterns

Heirloom Sideways Motion



Novelty Stitches

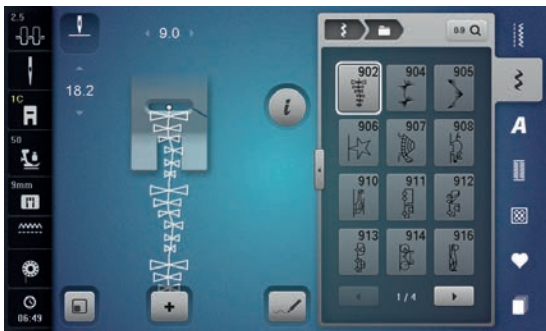

Novelty Sideways Motion



Tassel stitches



Filigree Stitches Sideways Motion

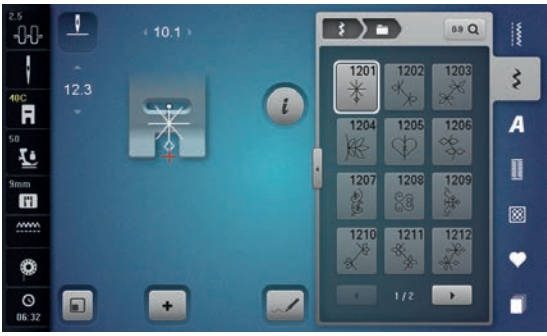

Quilt stitches

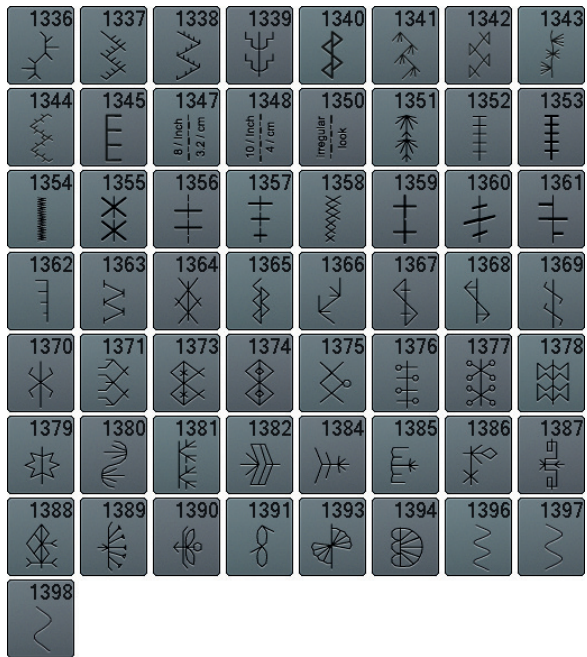

Tapering Stitches

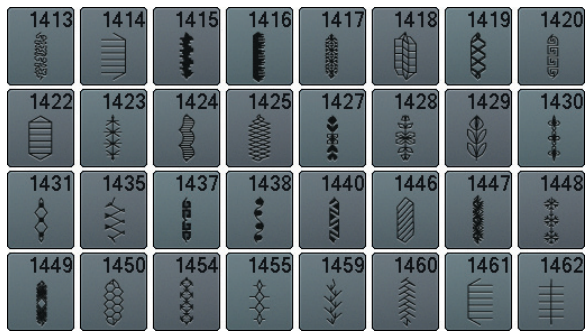
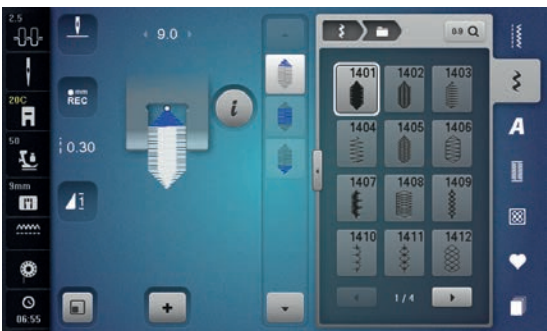

Stitch patterns

Skyline Stitches



International

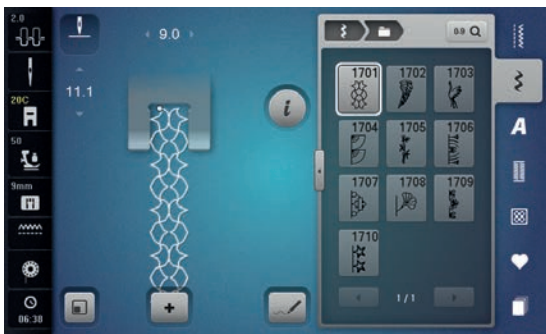

Alphabets

Block alphabet



M	N	O	P	Q	R	S	T
U	V	W	X	Y	Z	Ä	À
Â	Å	Æ	Ç	È	É	Ê	Ñ
Ö	Œ	Ø	Ü	1	2	3	4
5	6	7	8	9	0	-	-
•	'	!	+	=	&	÷	?
%	@	()	[]		



m	n	o	p	q	r	s	t
u	v	w	x	y	z	ä	à
â	å	æ	ç	è	é	ê	ñ
ö	œ	ø	ü				

Double-Block



M	N	O	P	Q	R	S	T
U	V	W	X	Y	Z	Ä	À
Â	Å	Æ	Ç	È	É	Ê	Ñ
Ö	Œ	Ø	Ü	1	2	3	4
5	6	7	8	9	0	-	-
•	'	!	+	=	&	÷	?
%	@	()	[]		

Stitch patterns



Script

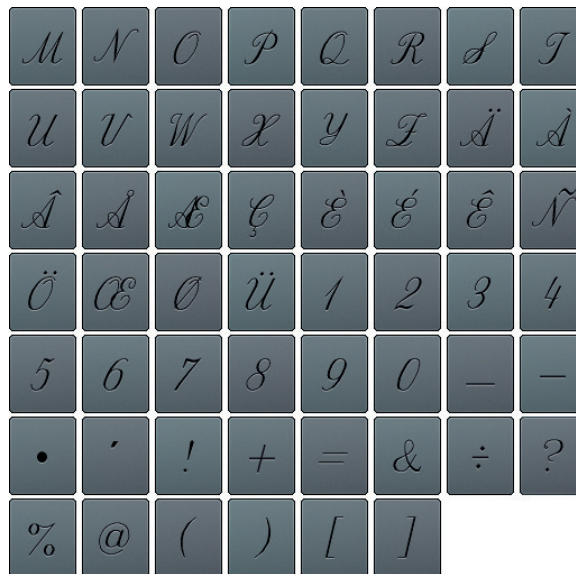

Alphabet Quilting Text

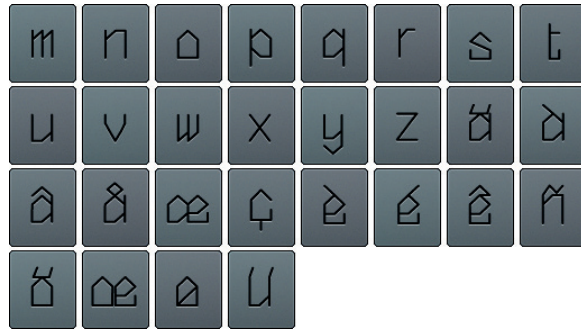

Stitch patterns

Comic Sans

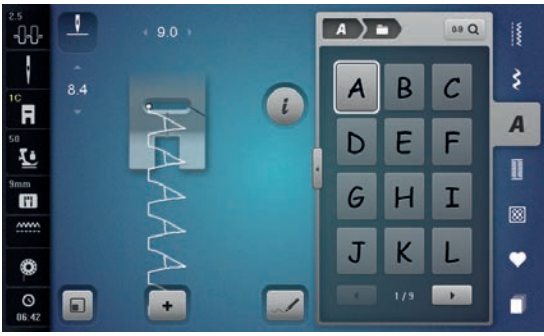

Monograms

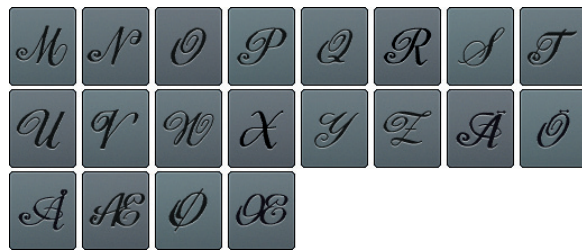

Cyrillic



Cyrillic Script



А	М	Н	О	П	Р	С	Т
У	Ф	Х	Ц	Ч	Ш	Щ	Ъ
Ы	Ь	Э	Ю	Я	Ә	Ғ	Қ
Ғ	Ө	Ү	Ү	Һ	І	Ҙ	Ј
Љ	Њ	Ћ	Ќ	Г	Є	Ї	Ў
È	É	Š	Ŕ	Ů	1	2	3
4	5	6	7	8	9	0	_
-	•	·	!	+	=	&	÷
?	%	@	()	[]	



а	м	н	о	п	р	с	т
у	ф	х	ц	ч	ш	щ	ъ
ы	ь	э	ю	я	ә	ғ	қ
Ғ	Ө	Ү	Ү	Һ	І	Ҙ	Ј
Љ	Њ	Ћ	Ќ	Г	Є	Ї	Ў
è	é	š	Ŕ	Ů			

Hiragana



す	せ	そ	た	ち	つ	て	と
な	に	ぬ	ね	の	は	ひ	ふ
へ	ほ	ま	み	む	め	も	や
ゆ	よ	ら	り	る	れ	ろ	わ
を	ん	あ	い	う	え	お	や
ゆ	よ	っ	が	ぎ	ぐ	げ	ご
ざ	じ	ず	ぜ	ぞ	だ	ぢ	づ
で	ど	ば	び	ぶ	べ	ぼ	ぱ
ぴ	ぷ	ぺ	ぽ	1	2	3	4
5	6	7	8	9	0	_	-
.	?	!	。	,	「	」	『
』							

Stitch patterns

Katakana



ス	セ	ソ	タ	チ	ツ	テ	ト
ナ	ニ	ヌ	ネ	ノ	ハ	ヒ	フ
ヘ	ホ	マ	ミ	ム	メ	モ	ヤ
ユ	ヨ	ラ	リ	ル	レ	ロ	ワ
ヲ	ソ	ア	イ	ウ	エ	オ	ヤ
ユ	ヨ	ッ	ガ	ギ	グ	ゲ	ゴ
ザ	ジ	ズ	ゼ	ゾ	ダ	ヂ	ヅ
デ	ド	バ	ビ	ブ	ベ	ボ	パ
ピ	プ	ペ	ポ	1	2	3	4
5	6	7	8	9	0	_	-
.	?	!	。	,	「	」	『
』							

Kanji



生	日	年	才	組	保	育	幼
稚	園	小	中	学	校	月	火
水	木	金	土				

Overview Motifs

Diane Gaudynski

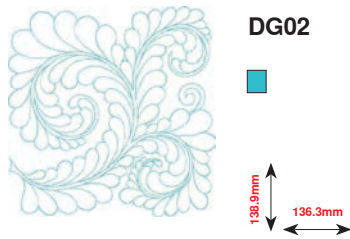

DG02

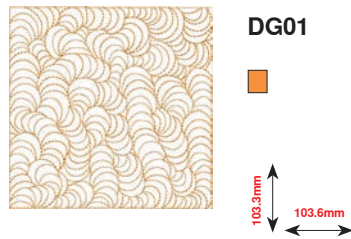
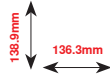

DG01

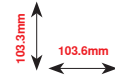

DG03

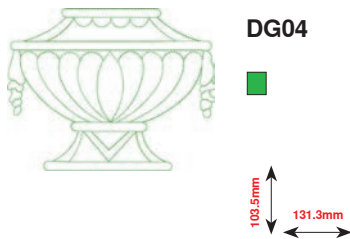
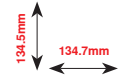

DG04

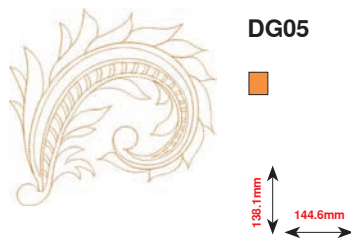
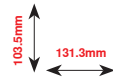

DG05

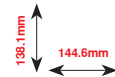

DG06

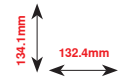

DG07

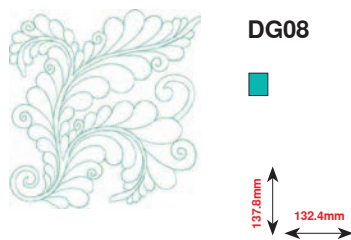
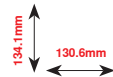

DG08

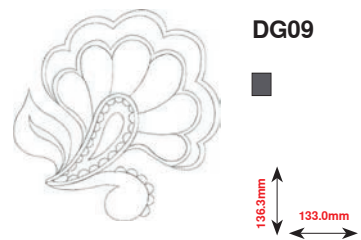
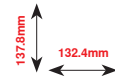

DG09

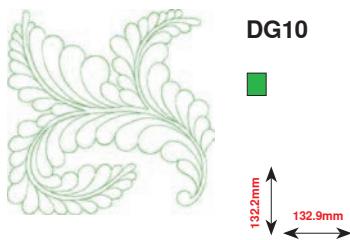
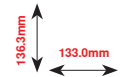

DG10

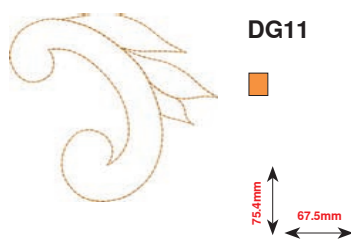
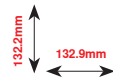

DG11

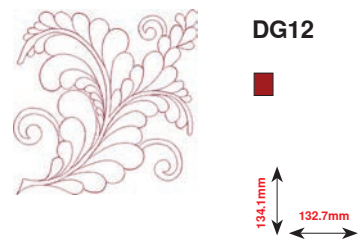
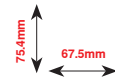

DG12

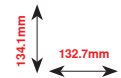

If you see one of the following pictograms below a number of the embroidery motif, you can find additional information at www.bernina.com/8series.



Detached point



Punchwork Design (sample)



Hole embroidery



Cord embroidery



Fringe embroidery



Projects in the hoop



Appliqué



Puffy fonts



CutWork Design (motif)



Quilting



PaintWork Design (motif)



Trapunto



CrystalWork Design (motif)



DG13



90.4mm
127.5mm



DG14



136.8mm
132.9mm



DG15



134.9mm
134.3mm



DG16



134.8mm
136.0mm



DG17



132.5mm
135.4mm



DG18



120.2mm
107.3mm



DG19



140.3mm
132.6mm



DG20



141.3mm
129.9mm



DG21



133.4mm
134.9mm













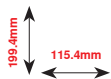

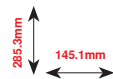

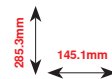

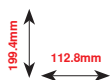

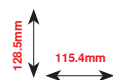

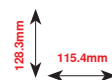

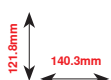

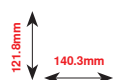

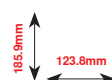

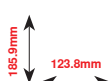

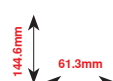

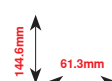

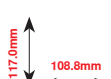

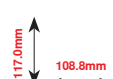
DG22

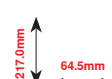

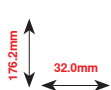
139.7mm
132.1mm

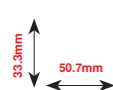
Exotic Rainforest

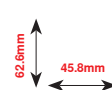
	<p>BE10704*</p>  		<p>BE10701*</p>  		<p>BE10702*</p>  
	<p>BE10703*</p>  		<p>BE10705*</p>  		<p>BE10706*</p>  
	<p>BE10707*</p>  		<p>BE10708*</p>  		<p>BE10709*</p>  
	<p>BE10710*</p>  		<p>BE10711*</p>  		<p>BE10712*</p>  
	<p>BE10713*</p>  		<p>BE10714*</p>  		<p>BE10715*</p>  
	<p>BE10716*</p>  		<p>BE10717*</p>  		<p>BE10718*</p>  

* This design has special effects. For more information please go to www.bernina.com/8series.



BE10719*

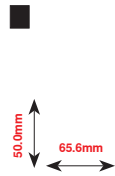

BE10720*

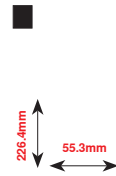

BE10721*

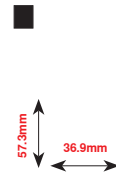

BE10722*

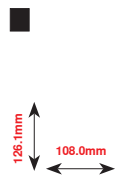

BE10723*



BE10724*

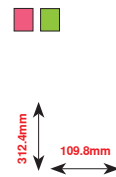

BE10725*

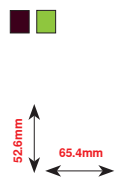

BE10726*



BE10727*



BE10728*

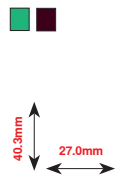

BE10729*

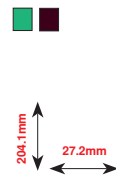

BE10730*

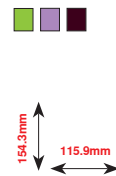

BE10731*

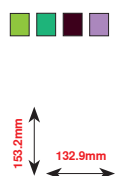

BE10732*

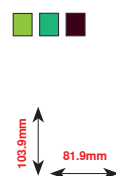

BE10733*



BE10734*

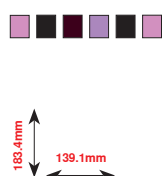

BE10735*

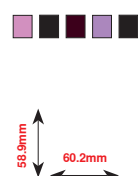

BE10736*

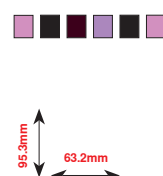

* This design has special effects. For more information please go to www.bernina.com/8series.

Embroidery motifs



BE10737*

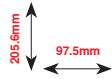

BE10738*

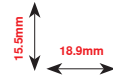

BE10739*

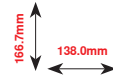

BE10740*

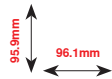

BE10741*

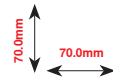

BE10742*

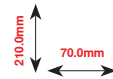

BE10743*

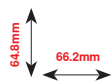

BE10744*

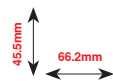

BE10745*

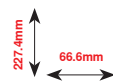

BE10746*

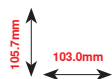

BE10747*

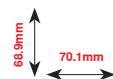

* This design has special effects. For more information please go to www.bernina.com/8series.

Floral Etchings

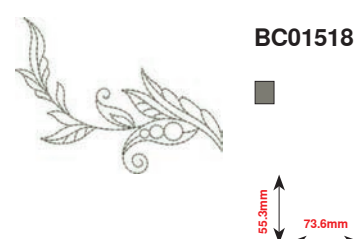
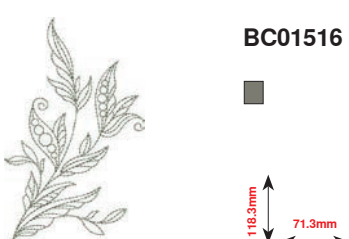
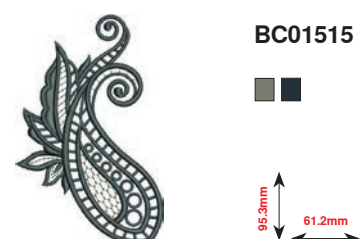
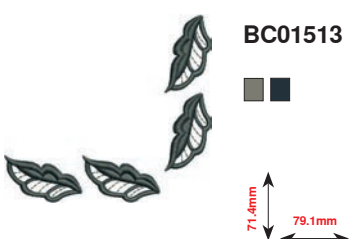
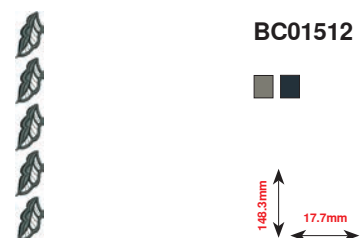
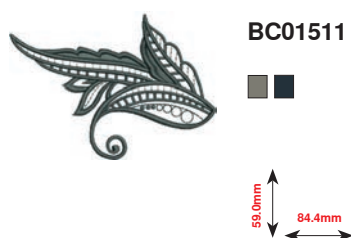
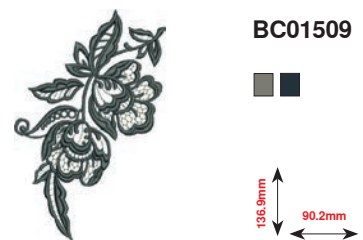
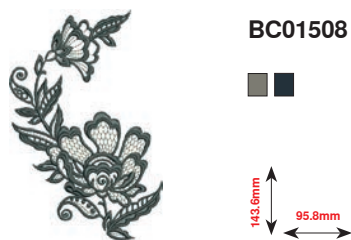
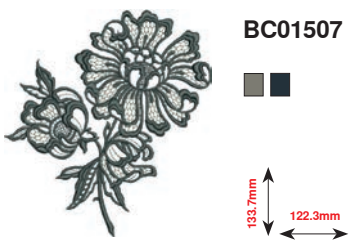
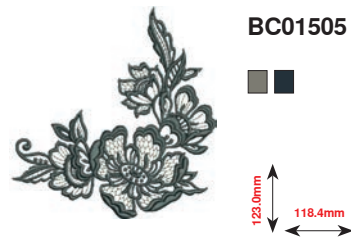
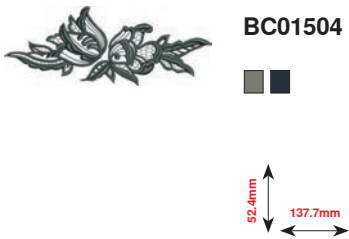
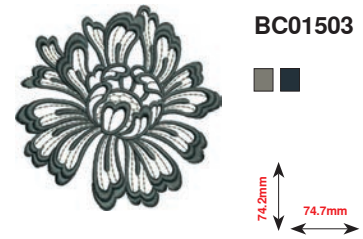
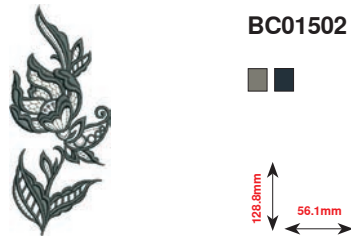
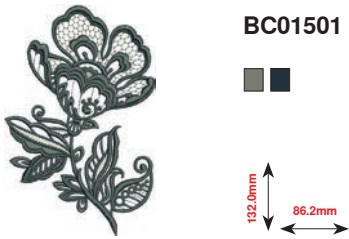

Embroidery motifs



BC01519

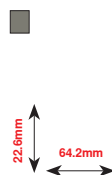

BC01520

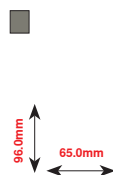

BC01521

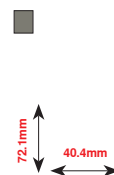

BC01522

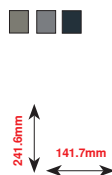

BC01523

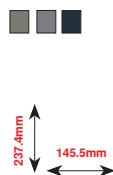

BC01524

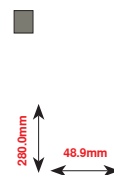

BC01525

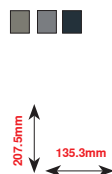

BC01526

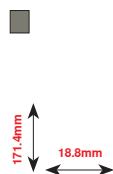

BC01527

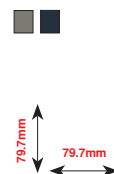

BC01528



BC01529

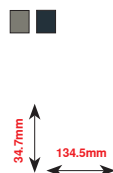

BC01530

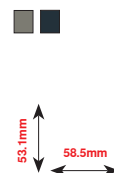

BC01531

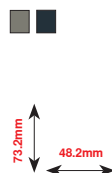

BC01532

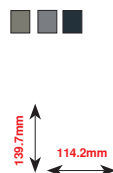

Projects

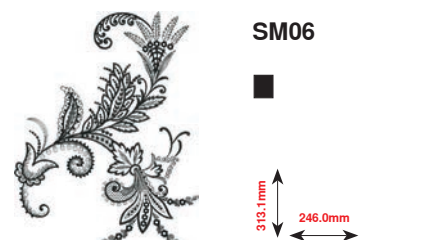
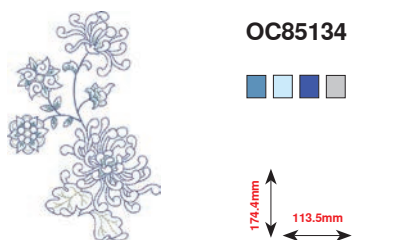
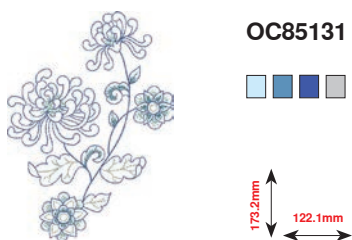
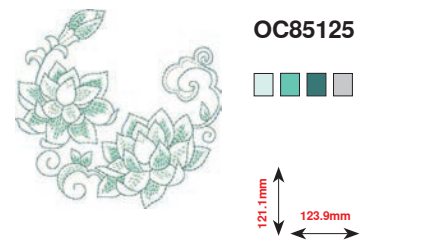
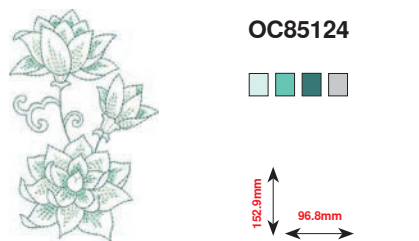
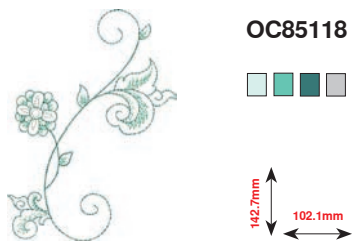
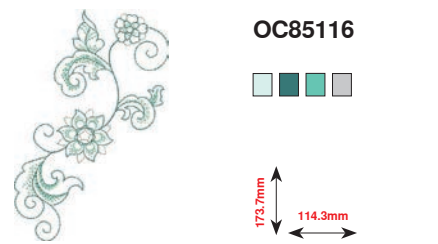
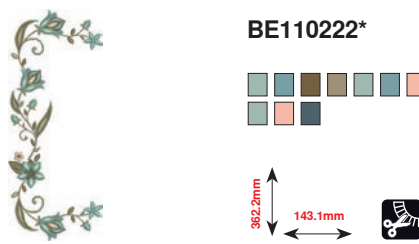
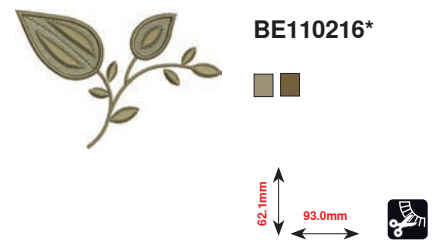
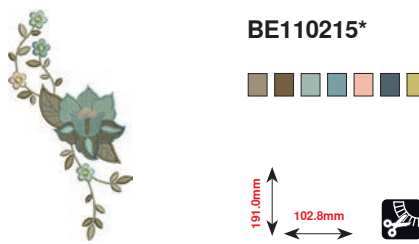
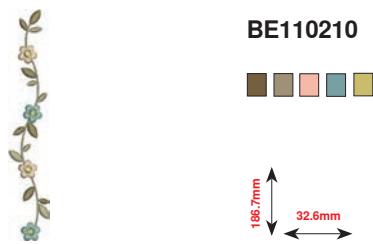
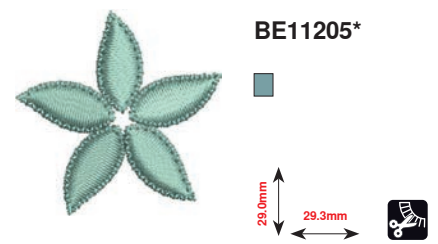
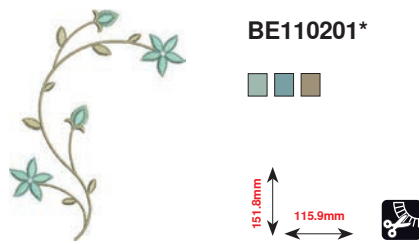
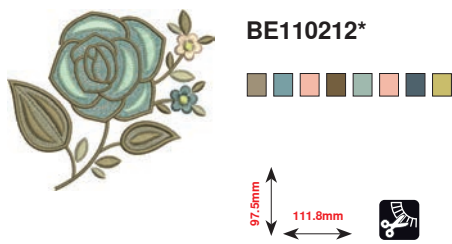

* This design has special effects. For more information please go to www.bernina.com/8series.

Embroidery motifs

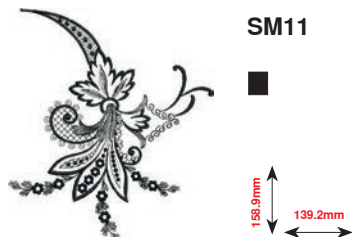
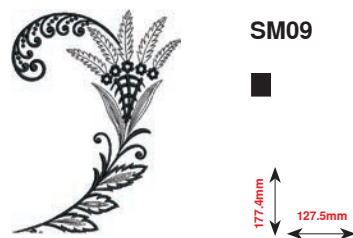
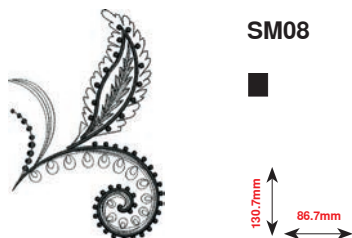
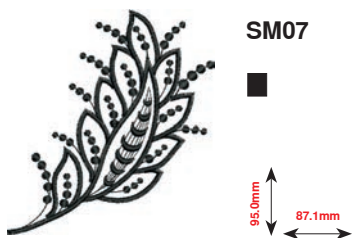

Shaping designs

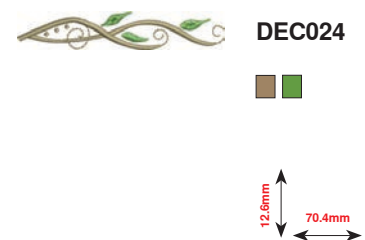
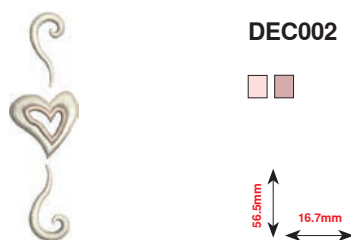
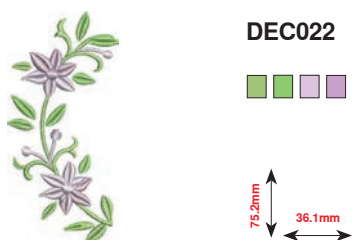
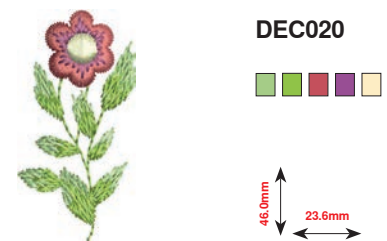
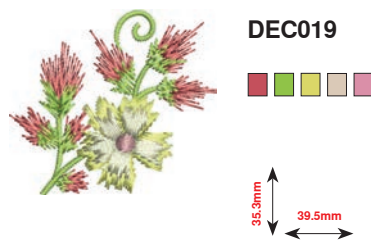
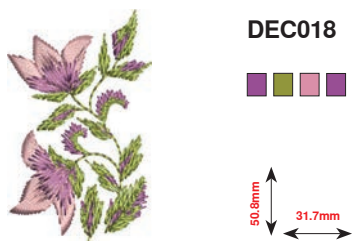
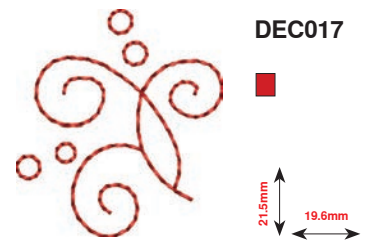
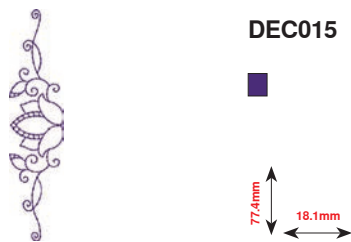
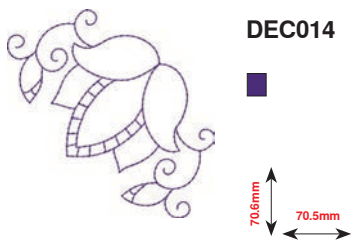
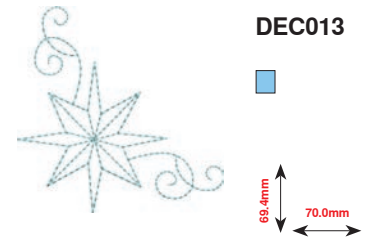
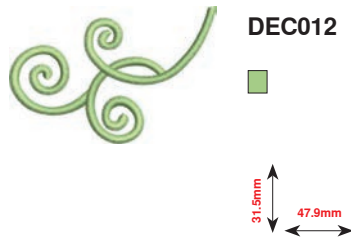
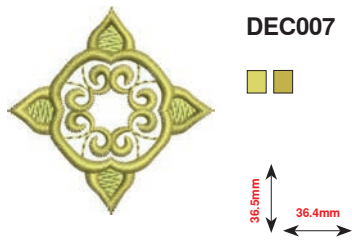
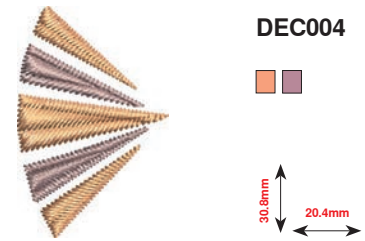
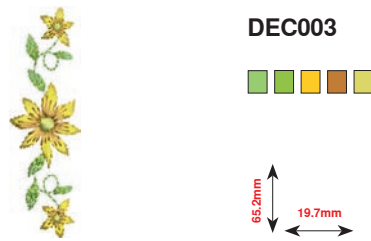
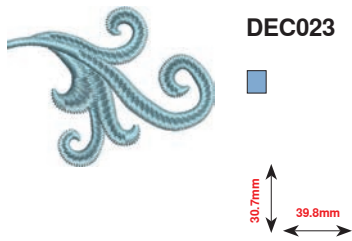

Embroidery motifs



DEC025

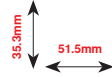

DEC026

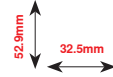

DEC027

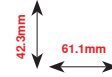

DEC028

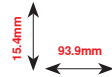

DEC029

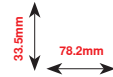

DEC030

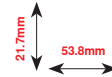

DEC032

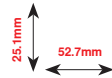

DEC033

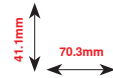

DEC034

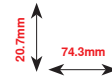

DEC037

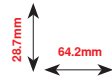

DEC042

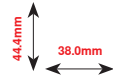

DEC043

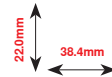

DEC044

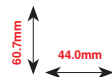

DEC045

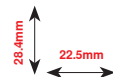

DEC046

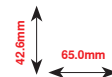



DEC061

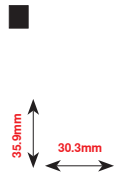

DEC062

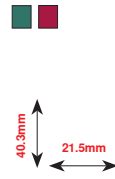

DEC063

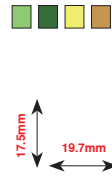

DEC064

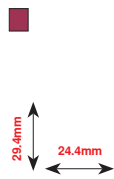

DEC065

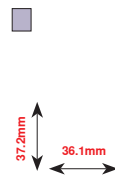

DEC067

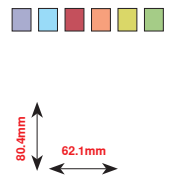

DEC068

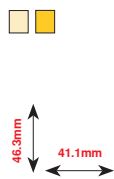

DEC071

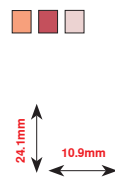

DEC074

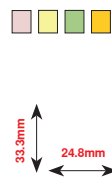

DEC075

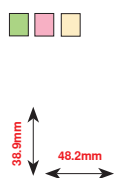

DEC082

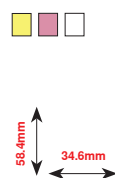

DEC084

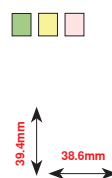

DEC088

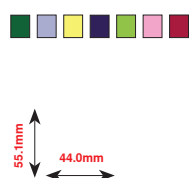

DEC091

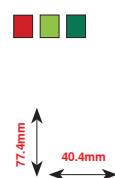

DEC092

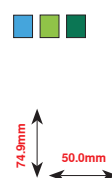

Embroidery motifs



DEC094

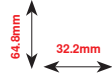

DEC095

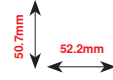

DEC096

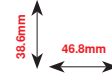

DEC098

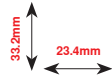

DEC100

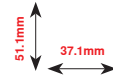

DEC101

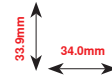

DEC102

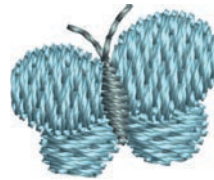
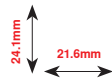

DEC103

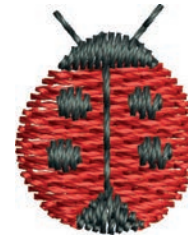
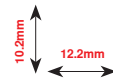

DEC104

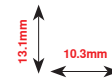

DEC105

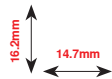

DEC106

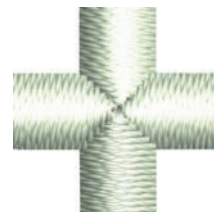
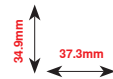

DEC107

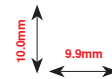

Monograms



D765



81.0mm
82.7mm



D766



85.6mm
65.1mm



D767



93.5mm
69.3mm



D768



90.9mm
71.7mm



D769



90.4mm
70.1mm



D770



89.3mm
59.9mm



D771



89.8mm
66.2mm



D772



86.1mm
70.3mm



D773



85.5mm
49.0mm



D774



85.2mm
59.8mm



D775



86.6mm
73.7mm



D776



88.9mm
66.4mm



D777



82.4mm
76.8mm



D778



77.7mm
68.9mm



D779



81.3mm
63.9mm

Embroidery motifs



D780



85.3mm
63.4mm



D781



86.5mm
64.0mm



D782



84.5mm
65.7mm



D783



88.1mm
58.3mm



D784



89.3mm
66.2mm



D785



81.1mm
71.8mm



D786



82.7mm
73.2mm



D787



86.6mm
80.4mm



D788



86.9mm
74.7mm



D789



86.2mm
73.9mm



D790



84.8mm
58.3mm



D791



77.2mm
50.1mm



D792



50.4mm
56.8mm



D793



77.3mm
48.6mm



D794



59.1mm
54.5mm

DesignWorks designs

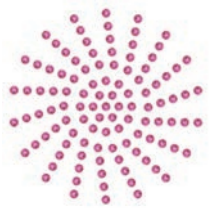

DW11*

7.93mm
7.89mm



DW06*

SS 10
SS 12

121.8mm
121.8mm



DW07*

117.3mm
154.9mm



DW09*

106.2mm
125.6mm



DW01*

115.8mm
138.0mm



DW02*

113.3mm
191.0mm



DW03*

177.4mm
335.2mm



DW04*

232.5mm
249.6mm



DW05*

105.4mm
94.0mm



DW10*

184.4mm
184.4mm



DW08*

208.7mm
102.5mm



BE700121

207.5mm
206.5mm



Sm;)e

BE700122

37.0mm
119.4mm

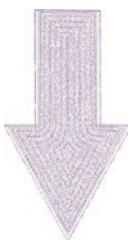

BE700123

205.8mm
112.7mm



BE700124

134.4mm
141.0mm



* This design has special effects. For more information please go to www.bernina.com/8series.

BC Embellishment



NB403

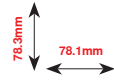

NB728

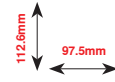

HG079

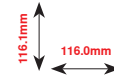

FQ881

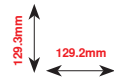

FB336

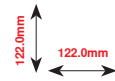

FB377

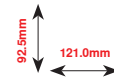

FB385

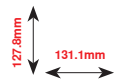

NB646

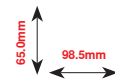

FQ072

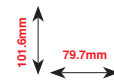

NB101

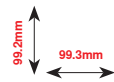

NB708

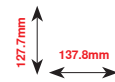

FB433

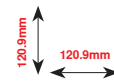

FB106

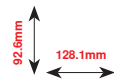

FB323

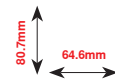

FB335

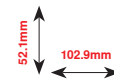

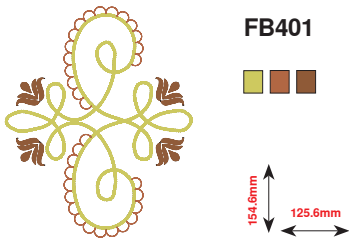

FB401

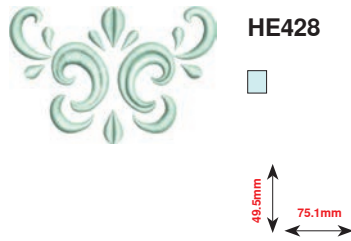
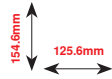

HE428

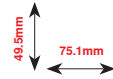

HG203

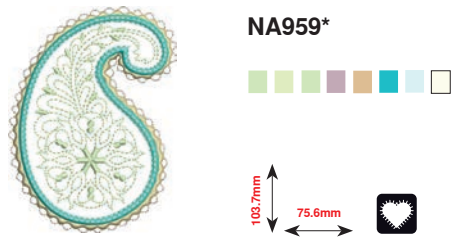
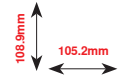

NA959*

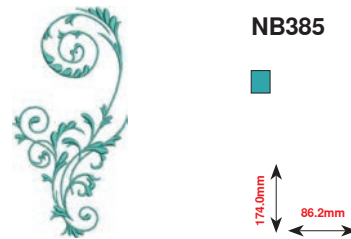
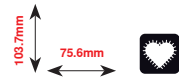

NB385

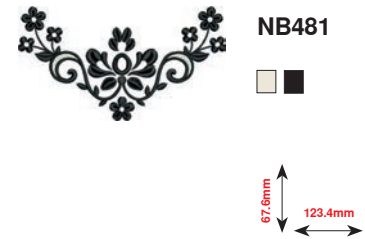
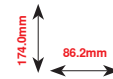

NB481

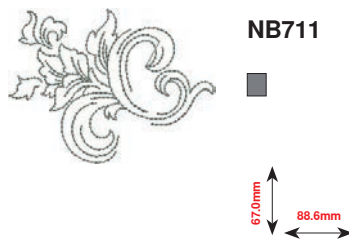
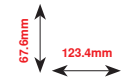

NB711

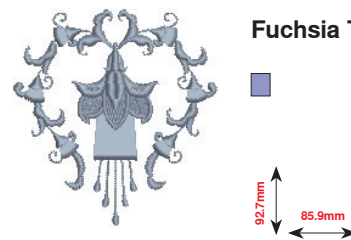
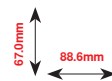

Fuchsia Tassel

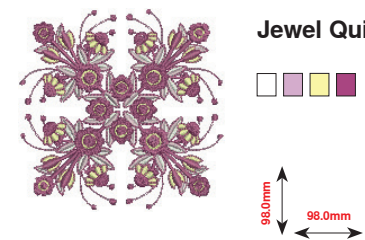
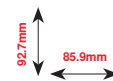

Jewel Quilt

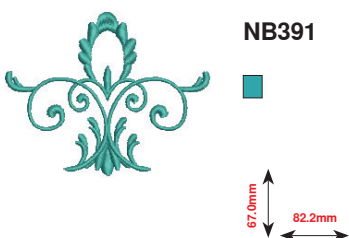
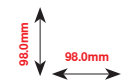

NB391

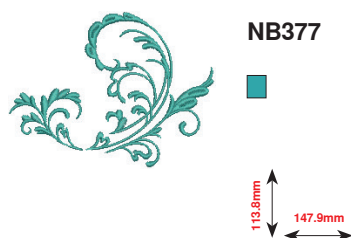
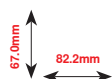

NB377

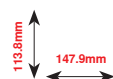

HG318

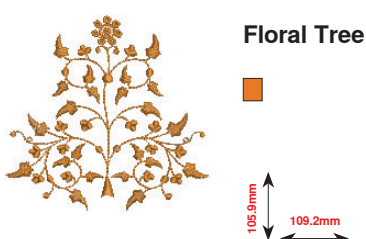
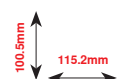

Floral Tree

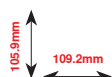

* This design has special effects. For more information please go to www.bernina.com/8series.

BC Quilting



BD569

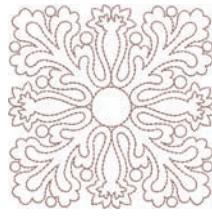
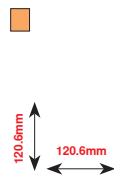

BD554



BD567

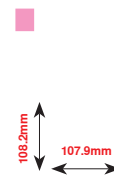

BD394



BD553

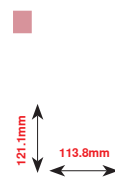

BD412



BD513

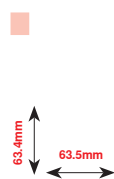

BD501

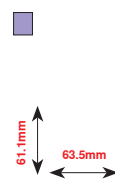

BD568



BD562

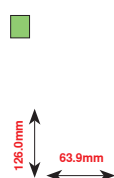

BD563

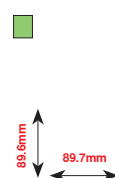

BD666

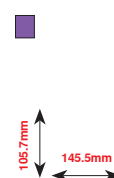

BD669

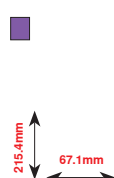

Quilt10

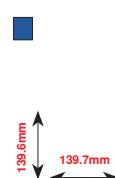

Quilt07

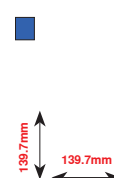



Quilt9

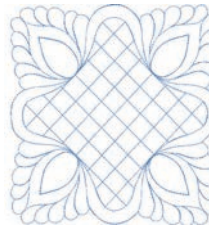

Quilt11

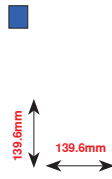

Quilt02

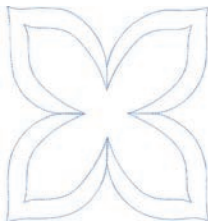
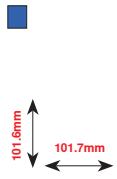

Quilt03

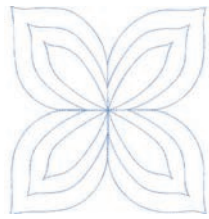

Quilt 04

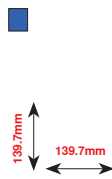

BC Borders



NX952

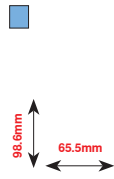

NX696

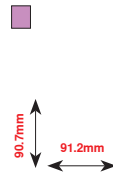

NX957

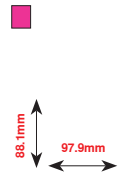

HG341

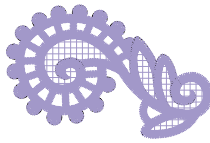
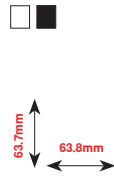

FB422*

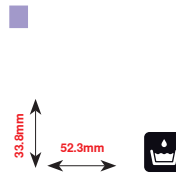

FB436

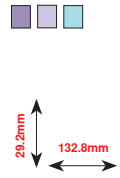

FQ559

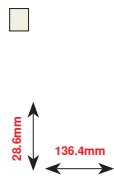

NA914

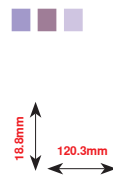

NA912

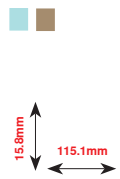

NA909

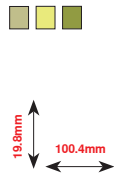

OC33411



CM473

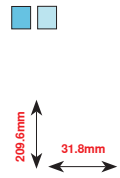

NB520



Battenburg Border



FQ408

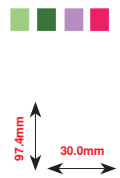

* This design has special effects. For more information please go to www.bernina.com/8series.



FQ810

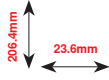

D349

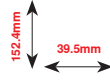

CM471

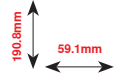

FQ785

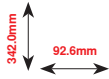

BD582

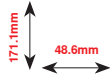

BC Flowers



FQ061

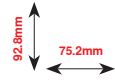

FQ801

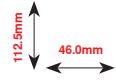

FQ273

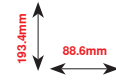

FQ055

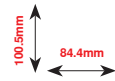

FQ905

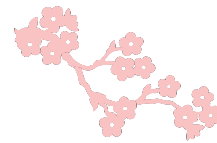
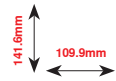

FB478

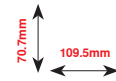

WS641

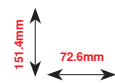

FQ041

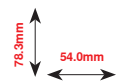

FM443

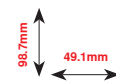

WS655

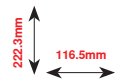

CM418

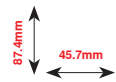

FP246

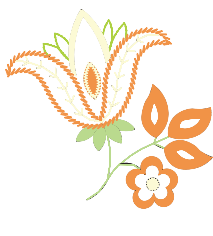
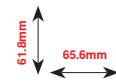

FP814

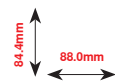

FQ522

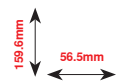

FQ527

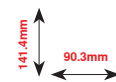



FQ562

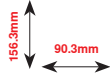

Aster

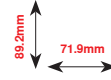

Rose

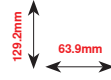

FQ722

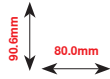

FB268

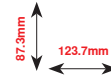

BC Seasons



HG053

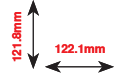

HE919

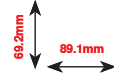

HE543

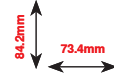

CM426

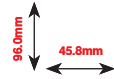

NB317

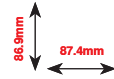

CM287

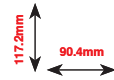

NB039

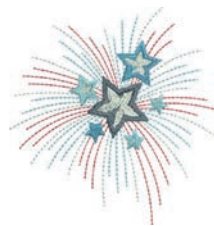
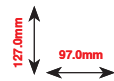

HG460

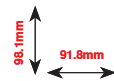

NB769

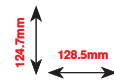

BD603

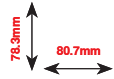

FQ749

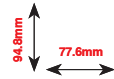

Snowman

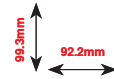

Pumpkin and Pansy

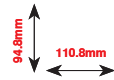

Sunflower

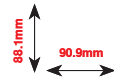

Fireworks

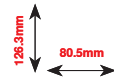

NA241

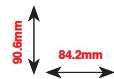

Snowflake

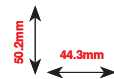

HG319

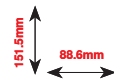

BC Children



CK970

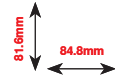

RC765

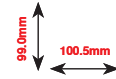

CM384

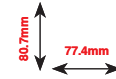

CK511

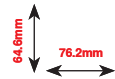

CM147

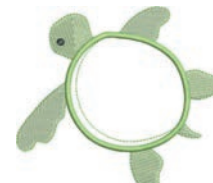
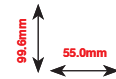

CM362*

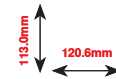

CM022

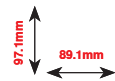

CM442

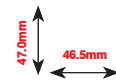

CM368

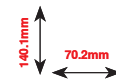

WP325

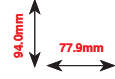

CM193*

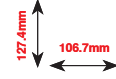

CK667*

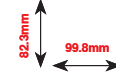

CK738

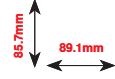

Cow and Kitty

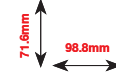

Duck Family

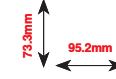

* This design has special effects. For more information please go to www.bernina.com/8series.

Embroidery motifs



Puppy

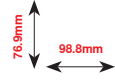

Turtle

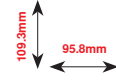

Dinosaur

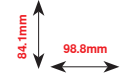

Stargazer

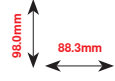

HE456

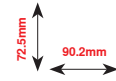

Bunny

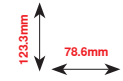

BC Hobby



SP980

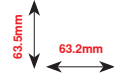

LT870

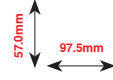

NB036

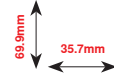

Air Ballon

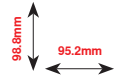

SR067

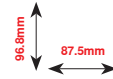

SP989

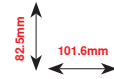

SP266

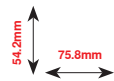

Race car

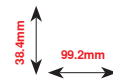

RC675

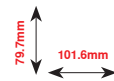
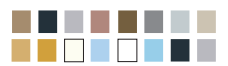

RC244

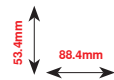

SR589

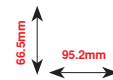

FB158

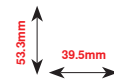

LT604

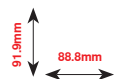

SR551

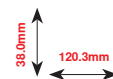

FB148

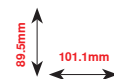

BC Animals



MT028



93.4mm
103.3mm



CM142



66.7mm
56.5mm



FQ617



198.3mm
118.0mm



WM785



103.4mm
84.6mm



FQ624



144.2mm
64.5mm



WP217



78.1mm
93.9mm



WP244



172.4mm
136.8mm



WS610



111.1mm
127.3mm



LJ599



98.0mm
93.2mm



FQ394



98.6mm
98.3mm



FQ515



67.1mm
118.5mm



LJ600



98.2mm
95.7mm



WM783



124.1mm
109.1mm



Jewel Butterfly



69.5mm
88.6mm



FQ600



116.9mm
112.6mm



FQ106



108.9mm
109.3mm

BC Flowers Outline

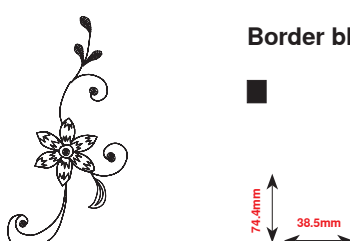
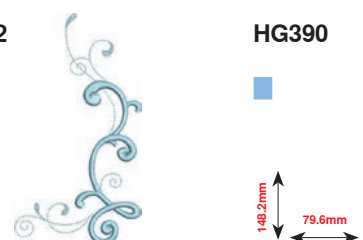
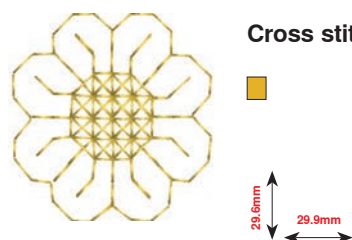
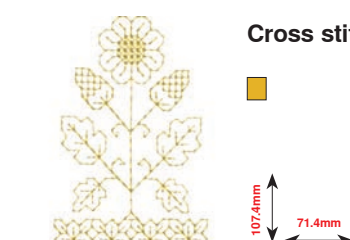
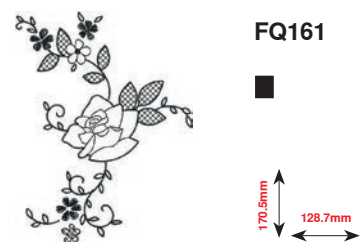
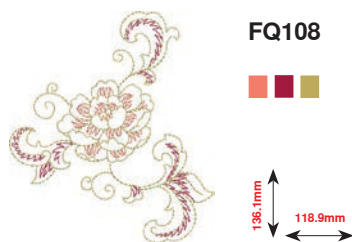
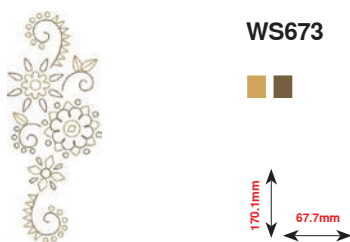
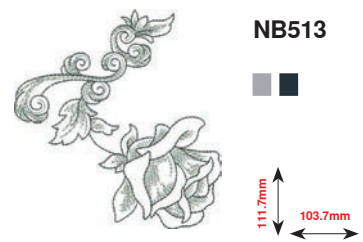
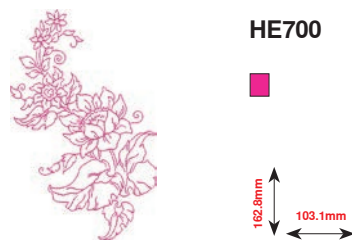
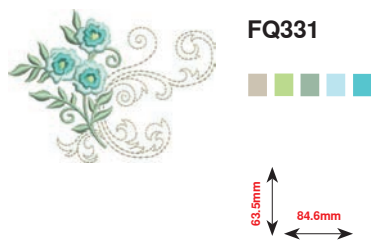
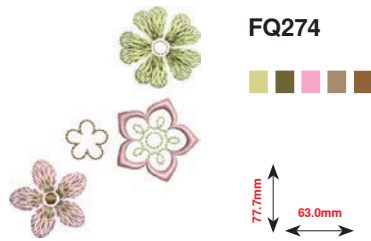
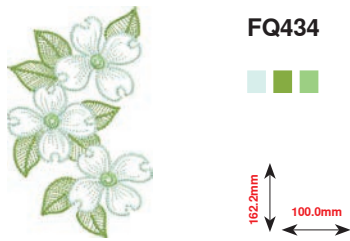

BC Switzerland



019_Swiss



129.4mm
150.4mm



007_Flower



44.8mm
42.4mm



008_Flower



68.9mm
102.9mm



002_Bell

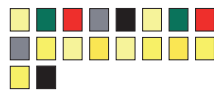

106.0mm
50.4mm



022_Swiss



37.1mm
29.3mm



009_Flower



68.9mm
102.1mm



011_Flowers



102.5mm
77.9mm



013_Garland



32.2mm
102.8mm



012_Flowers



87.2mm
78.8mm



023_Village



51.2mm
191.6mm

Projects

Please find the embroidery instructions at www.bernina.com/880PLUSdesigns



BE700701

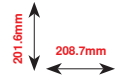

12604-02

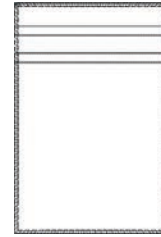
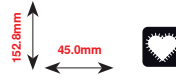

21519-03

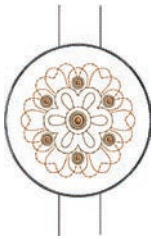
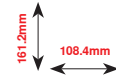

19999-032

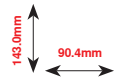

Charming Monograms

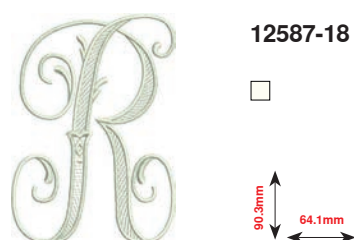
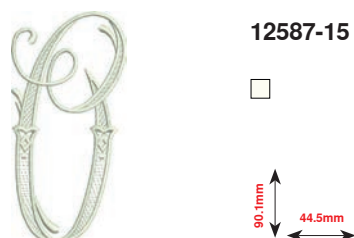
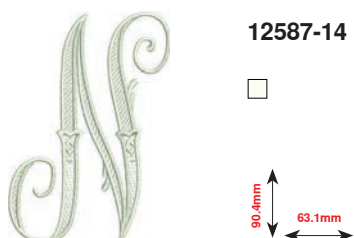
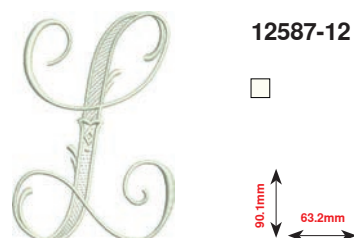
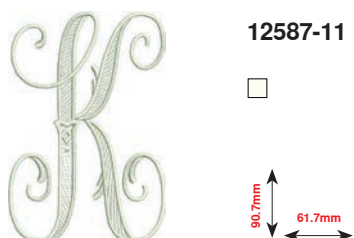
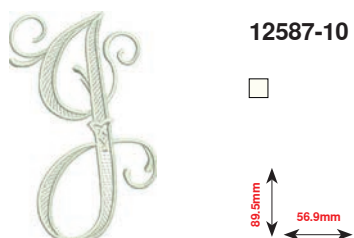
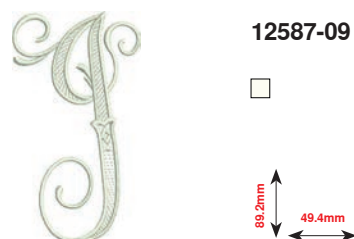
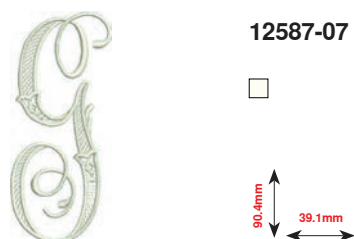
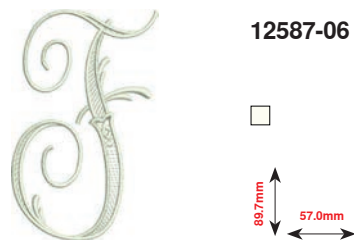
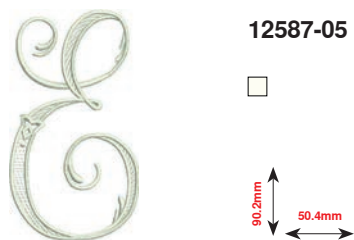
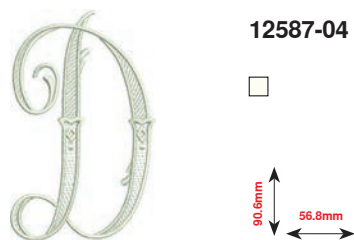
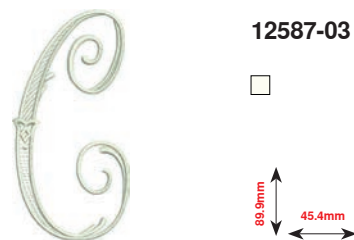
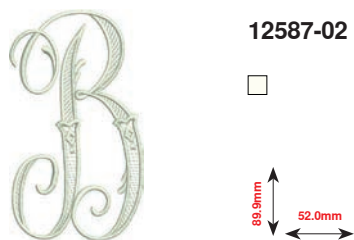
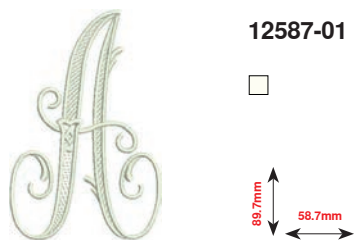

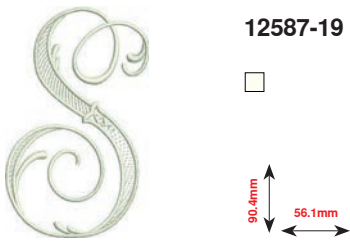

12587-19

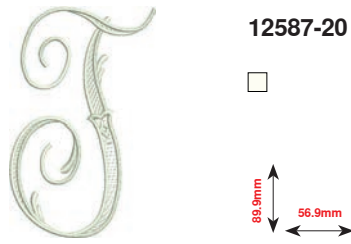
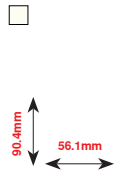

12587-20

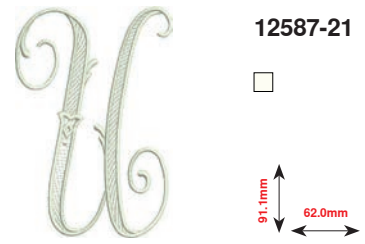
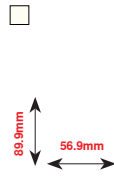

12587-21

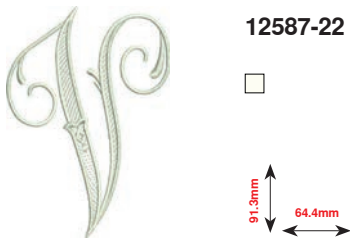
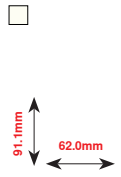

12587-22

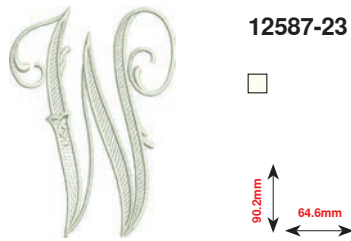
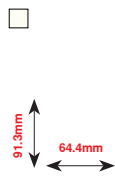

12587-23

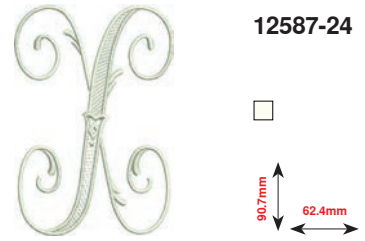
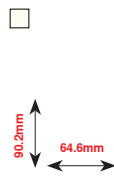

12587-24

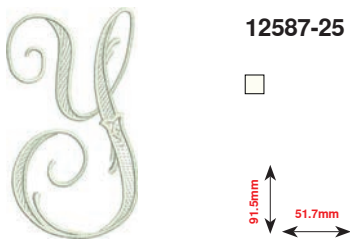
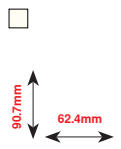

12587-25

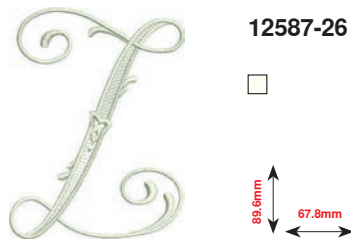
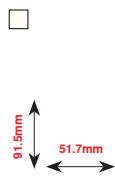

12587-26

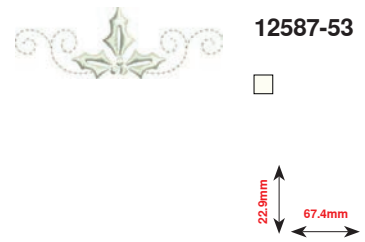
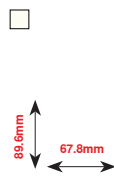

12587-53

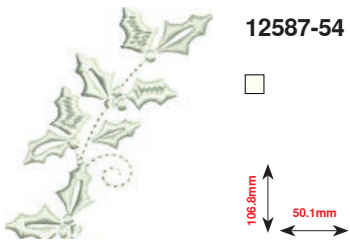
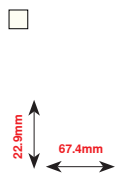

12587-54

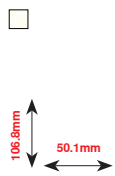

12587-55

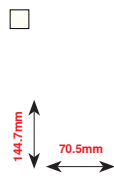

12587-56



12587-57

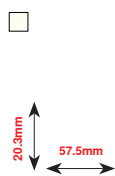

12587-58

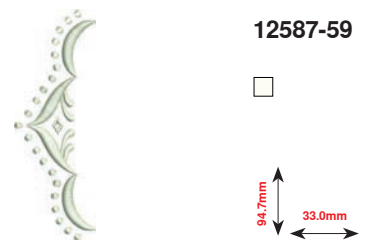
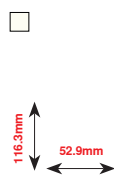

12587-59

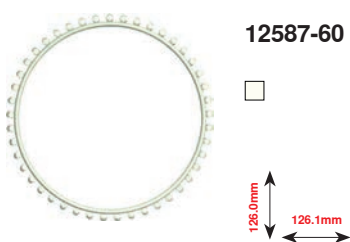
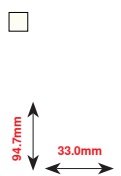

12587-60

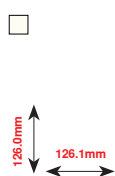

12587-61

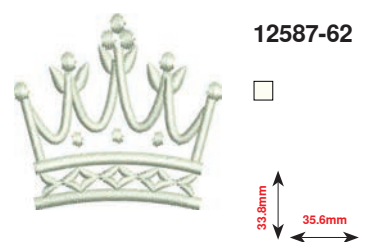

12587-62

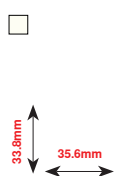

Embroidery motifs

Homedeco



12535-03



120.3mm
160.6mm



82011-30



130.3mm
107.2mm



82011-28



99.4mm
133.6mm



82006-02



205.1mm
128.6mm



WP428



119.0mm
123.4mm



12576-05



228.4mm
189.5mm



12473-04



184.2mm
93.6mm



12620-12



109.4mm
94.6mm



12611-08



119.7mm
80.0mm



12611-18



157.6mm
130.2mm



BE790801



137.7mm
137.8mm



BE790802



116.9mm
36.2mm



BE790803



215.9mm
22.4mm



WP423



157.9mm
90.4mm



21027-01



122.2mm
123.0mm



21027-14



120.8mm
120.8mm



21027-16



151.8mm
57.4mm



21027-17



151.4mm
57.3mm

Alphabets

Drifter

ABC

Drifter

A
B
C

Childs Play

ABC

Childs Play

A
B
C

Victoria

ABC

Victoria

A
B
C

King Charles

ABC

King Charles

A
B
C

Alice

ABC

Alice

A
B
C

Chicago

ABC

Chicago

A
B
C

Anniversary

ABC

Anniversary

A
B
C

Swiss Block

ABC

Swiss Block

A
B
C

Quilt Block

ABC

Old English

ABC

Old English

ABC

Russian Textbook

АБВ

Russian Textbook

А
Б
В

Jikharev

АБВ

Jikharev

А
Б
В

Bamboo

ABC

Lisa

Zürich

Flare Serif

Deco block

ABC

ABC

ABC

ABC

Condensed Sans

Curly

Happy Times

Rounded Sans

ABC

ABC

ABC

ABC

Index

- A**
-
- Absolute Embroidery check** 185
- Add a motif** 170
- Accessory**
- Embroidery 151
 - Presser feet 12
 - Sewing 11-13
 - Storage example 13
- Accessory box** 13
- Acoustic signals**
- Altering 61
 - BSR 61
 - Function 61
 - Stitch patterns 61
- Adjusting**
- Lower thread tension 31
 - Needle position 39
 - Presser foot pressure 34
 - Upper thread tension 30, 53, 57, 125, 168
- Air vents** 15
- Alarm** 35, 40, 168, 169
- Alphabets**
- Alphabet in combination with functions 136
 - Altering letter size 136
 - Back 165
 - Balance 47, 138
 - Big view of the display 135
 - Combining lettering 135
 - Correcting the combination 136
 - Correction 136, 177
 - Deleting lettering 136
 - Functions 47
 - Kinds of alphabets 134, 164, 165
 - Lettering 134
 - Main display/Menu selection 40
 - Monograms 137, 138, 230
 - Overview 134, 164, 165
 - Perfect stitch formation 134
 - Selecting 134, 164, 165
 - Selecting lower case letters 136
 - Upper-/lower case lettering 47, 136
 - With functions 136
- Altering**
- Acoustic signals 61
 - Brightness 62
 - Display settings 61, 62
 - Embroidery settings 52, 57-59
 - Presser foot pressure 34
 - Sewing light 62
 - Upper thread tension 30, 53, 57, 168
 - Welcoming text 60
 - Winding speed 22
- Altering pattern length** 42, 43, 47, 48
- Altering stitch**
- Length 81
 - Width 81
- Altering stitch density** 42, 43
- Altering stitch length** 81
- Altering stitch width** 81
- Altering winding speed** 22
- Attaching**
- BSR presser foot sole 127
 - Embroidery hoop 206
 - Embroidery module 156
 - Presser foot 27
 - Presser foot lifter 21
 - Slide-on table 20
 - Stitch plate 27
 - Touchscreen pen 19
- Automatic threader-button** 15, 38
- Automatic threading**
- Upper thread 24
- B**
-
- Back to basic settings** 30, 54, 63, 73, 80, 196
- Balance**
- Back to basic setting 73
 - BERNINA Dual Transport 73
 - Buttonhole 99
 - Correcting 72, 73
 - Practical- and decorative stitches, Alphabets 72
 - Sideways-motion 72
- Basic setting**
- Embroidery settings 52, 57-59
 - Presser foot pressure 34
 - Sewing settings 52, 53-56
 - Thread tension 30, 31
- Basting stitch** 77, 91
- Battery** 19, 211
- BERNINA Dual Transport** 132, 133
- BERNINA embroidery motifs** 166
- BERNINA stitch patterns** 166
- Bobbin** 13
- Bobbin cover** 15
- Bobbin filling** 34

- Bobbin winder pre-tension** 15
- Brightness** 62
- BSR** 126-130
- Attaching presser foot to sewing computer 127
 - Beeper/sound selection 129
 - Display 127
 - Functions 127
 - Modes 126
 - Needle stop 128
 - Preparation 127
 - Removing/attaching presser foot sole 127
 - Securing 128
 - Starting/Leaving 130
 - With straight stitch No. 1 126
 - With zig-zag stitch No. 2 126
- Button measuring**
- Automatic 101
- Button sew-on program** 95, 108
- Buttonhole** 94-109
- 5-steps, manually 107
 - 7-steps, manually 107
 - Adjusting the bead width 96
 - Altering stitch length 96
 - Automatic 100-104
 - Automatic Buttonhole Foot No. 3A 100-104
 - Automatic round and keyhole buttonhole 102
 - Balance 99
 - Button sew-on program 95, 108
 - Cording 98
 - Cutting open 98
 - Decorative buttonhole with double pointed bartack 95
 - Decorative keyhole buttonhole with horizontal bartack 95
 - Decorative Stretch Buttonhole 95
 - Double pointed bartack buttonhole 94
 - Double rounded buttonhole 94
 - Double rounded Heirloom buttonhole 94
 - Duplicating 100, 102
 - Eyelets 95, 105
 - Feed support 96
 - Height compensation 96
 - Heirloom buttonhole 94, 104
 - Important Information 96
 - In long term memory 105, 106
 - Keyhole buttonhole 94
 - Keyhole buttonhole with horizontal bartack 94
 - Keyhole buttonhole with pointed bartack 94
 - Manually 107
 - Marking 96
 - Narrow buttonhole 94
 - Overview 94, 95
 - Programming 100-104
 - Round buttonhole with horizontal bartack 94
 - Round buttonhole with normal bartack 94
 - Stabilizer and interfacing 97
 - Standard and stretch buttonhole 100
 - Standard buttonhole 94
 - Stitch counter buttonhole 104
 - Straight stitch buttonhole 94
 - Stretch buttonhole 94
- Test-sewing 96
 - With direct length entry 101
 - With double pointed bartack, narrow 94
- C**
-
- Cable**
- Connection 15, 20
 - Plugging in 20
 - Unwinding/winding 20
- Calibrating**
- Automatic Buttonhole Foot No. 3A 64
 - Display 62
 - Embroidery hoop 57
- Calibrating Automatic Buttonhole Foot No. 3A** 64
- Carrying handle** 15
- Changing**
- Bobbin 23
 - Needle 25
 - Presser foot 27
 - Stitch plate 27
- Cleaning**
- Cleaning 210, 211
- Close** 42, 170
- Combi mode**
- Adding stitch pattern 146
 - Adjusting length within the combination 146
 - Adjusting width within a combination 147
 - Balance 144
 - «Combi mode»-icon 144
 - «Combination overview»-icon 144
 - Combination subdivider 1 147
 - Combination subdivider 2 147
 - Connecting stitches 144
 - Correcting stitch pattern combination 146
 - Creating stitch pattern combination 143
 - Deleting 149
 - Deleting single stitches or the whole combination 144
 - Deleting stitch patterns 144
 - Editing complete combination 144
 - Editing stitch pattern 146
 - Enlarging the combination view 144
 - Letter size with alphabets 144
 - Long stitch 144
 - Mirror image left/right/down/up 144
 - Mirroring the whole combination 147
 - Moving parts of a combination 148
 - Moving single stitches in a combination 148
 - Moving single stitches or parts of a combination 144
 - Opening saved combination 145
 - Overview combination 144
 - Overwriting 149
 - Programming and saving 143
 - Reducing the combination view 144
 - Sewing combination in any direction 144
 - Sewing single stitches of a combination in any direction 148
 - Sewing the whole combination in any direction 148

- Stitch length of the active stitch pattern 144
 - Stitch width of the active stitch pattern 144
- Combination 48-51**
- Adjusting length in combination 50
 - Adjusting width in combination 50
 - Altering pattern length 48
 - Backstepping 48
 - Balance 48, 51
 - Balance BERNINA Dual Transport 48
 - Combination repeat 50
 - Combination subdivider (1) 49
 - Combination subdivider (2) 49
 - Connecting stitches 51
 - Deleting 48, 50, 51
 - Editing combination at cursor position 48
 - Editing complete combination 48, 51
 - Letter size with alphabets 48, 51
 - Long stitch (without alphabet) 48, 51
 - Mirror image left/right/down/up 48, 50, 51
 - Moving parts of a combination 51
 - Moving single stitches or parts of a combination 51
 - Permanent sewing in reverse 48
 - Securing 49
 - Sewing in any direction 48, 50, 51
- Compensating material 93, 96**
- Compensation**
- Height of seam 93
 - Layers 93
- Connecting stitches 51, 144, 155**
- Connection**
- BSR 15, 127
 - Embroidery module 152
 - Foot control 15, 19
 - Optional accessory 15
 - PC connection 15, 19
 - Power cable 15, 19
 - Presser foot lifter 15, 21
 - USB 15, 19
- Contents**
- Embroidery 7-9
 - Sewing 4-7
- Cording**
- Automatic Buttonhole Foot No. 3A 98
 - Buttonhole Foot No. 3C 98
 - Fixing 98
- Correcting**
- Practical-/Decorative stitches 72, 73
- Cover**
- Battery 211
 - Cover 213, 216
- Creative consultant**
- Leaving 70
 - Overview 70
 - Recommendations 70
 - Sewing techniques 70
 - Types of fabric 70
- D**
-
- Darning**
- Automatic 86
 - Manual 85
- Darning and embroidery thread 153**
- Darning hoop connection 15**
- Dealer details 67**
- Decorative stitches**
- Categories 110
 - Cross stitch 119
 - Overview 110
 - Pin tucks 120, 121
 - Selecting 110
 - Sewing lower thread 122
 - Stitch Designer 114-118
 - Tapering 111-113
- Deleting**
- Balance 99
 - Embroidery motifs 170, 171, 175, 204, 205
 - Stitch patterns 48, 51, 142
 - User data 63
- Details**
- Accessory 11-13, 151
 - Embroidery module 152
 - Sewing computer 14-15
- Display**
- Alphabets 40, 47, 78, 134
 - Balance 72
 - BSR 127
 - Buttonholes 46, 94
 - Calibrating 62
 - Combi mode 48-51
 - Creative consultant 40, 70
 - Decorative stitches 110
 - Edit 170, 171
 - Embroidery Alphabet 164, 165
 - Embroidery mode 162
 - Functions 42-51, 170-174
 - Help program 71
 - History 150
 - Main display 40-41, 164-167
 - Menu selection 40
 - Overview 40-51, 163-177
 - Practical stitches 76
 - Quilt stitches 123
 - Selecting the color 60
 - Selection 40-41
 - Settings 52-68
 - Setup 52-68
 - Stitch pattern area 41
 - Stitch pattern display 41
 - Tutorial 69
- Dual Transport 132, 133**

E	
eco	15, 40, 74
Edit	
• Add an embroidery motif	170
• Alter the embroidery size	170, 171
• Change stitch type	170, 171
• Check motif size	170, 171
• Color number	168
• Delete motif	170, 171
• Display	168
• Duplicate motif	170, 171
• Edit	168, 169
• Embroidery menu	174
• Endless embroidery	170, 171
• Feed dog recognition	168, 169
• Filling Bobbin status	168, 169
• Hoop relocater	172
• Hoop selection/Hoop Indicator	168, 172
• Letter manipulation	170, 171
• Mirror image left/right/down/up	170, 171
• Motif center	172
• Move motif	170, 171
• Move the embroidery hoop to the left	172
• Move the view of the motif	170
• Move the view of the motif within the embroidery hoop	170
• Overview	168-176
• Park embroidery hoop	172
• Presser foot indicator/Presser foot selection	168
• Rotate motif	171
• Security needle	168
• Security stitch plate	168
• Selection	168
• Shaping	170, 171
• Show Grid	172
• Time Display	168, 169
• Upper thread tension	168
• Virtual positioning	172
• Zoom minus	170
• Zoom plus	170
Embroidery	151-209
• Alphabet	164
• Embroidery motifs	166
• Embroidery sequence control	209
• Embroidery speed	207
• Menu	174
• Select hoop	206
• Start	206
• Via foot control	208
• Via the «Start/Stop»-button	207
Embroidery computer	
• Embroidery needle	18, 151, 153, 156
• Embroidery threads	17, 153
• Entry in embroidery mode	162
• Feed dog recognition	40, 168, 169
• «Function»-buttons	161
• Memory	202
• Preparation	156
• Straight-/CutWork stitch plate	157
Embroidery foot/Embroidery needle	156
Embroidery test	154
Embroidery hoop	
• Basting	174, 200
• Calibrating	57
• Center determination	158
• Hoop relocater	172
• Hoop selection/Hoop Indicator	172
• Hooping material	158
• Motif center	172
• Move the embroidery hoop to the left	172
• Moving	174
• Park embroidery hoop	172
• Selection	168, 172
• Show Grid	172
• Using the hoop	158
• Virtual positioning	172
Embroidery menu	
• Basting	174
• Color information bar	174
• Color number	174
• Color resequence	174
• Cutting connecting stitches	174
• Edit	174
• Embroidery menu	174
• Embroidery sequence control	174
• Endless embroidery	174
• Move hoop	174
• Reducing color changes	174
• Selection	174
• Single- or multi-colored motif	174
Embroidery module	
• Attaching	156
• Detail view	152
• Overview	152
• Parking	172
• Removing	156
Embroidery motifs	
• Alter the embroidery size	170, 171, 179, 180
• Altering embroidery motifs unproportionally	170, 171, 180
• By BERNINA	166
• Change thread brand	176, 198
• Check	185
• Color wheel	176, 197
• Colors	197-199
• Deleting	204, 205
• From USB-Stick	167, 202
• Lettering	193, 194
• Mirror image	180, 191
• Motif center	184
• Motif color information	176
• Motif size and embroidery time	186
• Moving	170, 171, 179
• Moving the view of the motif	170
• Opening	175
• Overview	152
• Overwriting	203
• Rotating	170, 171, 179, 191
• Saving	175, 202
• Scaling/sizing	154
• Selecting	177

- Single- or multi-colored 174, 199
 - Stitch patterns 166, 178
 - Zoom 170, 186
- Embroidery settings**
- Activating or deactivating securing stitches 58
 - Altering Embroidery speed control 57
 - Altering Upper thread tension 57
 - Automatic cut 58
 - Calibrating the hoop 57
 - Center the embroidery motif 57
 - Changing the measuring unit 59
 - Fabric Thickness 58
 - Function thread removal on/off 58
- Embroidery speed** 207
- Embroidery template** 151, 158
- Embroidery threads**
- Lower threads 153
 - Metallic threads 153
 - Polyester threads 153
 - Rayon threads 153
- Embroidery time** 186
- Embroidery-/Sewing computer**
- Cleaning 210, 211
 - Lubricating 64, 66, 210
 - Overview 14-15
 - Sewing computer settings 60-62
 - Troubleshooting 212-220
- Endless embroidery** 170, 171, 187, 188
- Entry**
- Embroidery mode 162
 - Sewing mode 162
- Environmental Protection** 3
- Examples of application**
- Buttonholes 94, 95, 100-107
 - Decorative stitches 119-122
 - Practical stitches 82-92
 - Quilt stitches 124, 125
- Eyelet**
- With small zig-zag 95, 109
 - With straight stitch 95, 109
- F**
-
- Fabric**
- BERNINA Dual Transport 132, 133
 - Center determination 158
 - Hooping 158
 - Needle and thread 16-18
 - Transport 36
- Fabric feed** 36
- Feed dog**
- Fabric feed 36
 - Position 34
- Fill stitches** 196
- Finishing edges** 88
- Foam pad** 29
- Foot control**
- Cable unwind/wind 20
 - Connection 15, 20
 - Plugging in 20
 - Raising and lowering the needle 20
 - Sewing speed control 20
- Front view**
- Sewing computer 14
- Function buttons** 38, 39, 161
- Automatic securing program 15, 39
 - Automatic thread cutter 15, 39, 161
 - Automatic threader 38, 161
 - Needle position 15, 39
 - Needle stop 15, 39
 - Presser foot position 15, 39, 161
 - Programmable pattern end/Securing 15, 38
 - Quick reverse 15, 38
 - Slide speed control 15, 38, 161
 - Start/Stop 15, 39, 161
 - Stitch width and stitch length knob 15, 39, 161
- Functions alphabets**
- Altering pattern length 47
 - Backstepping 47
 - Balance 47
 - Balance BERNINA Dual Transport 47
 - Letter size with alphabets 47
 - Mirror image left/right/down/up 47
 - Pattern repeat 47
 - Permanent sewing in reverse 47
 - Personal memory permanent 47
 - Reset 47
 - Sewing in any direction 47
- Functions buttonholes**
- Adjusting buttonhole length 46
 - Backstepping 46
 - Balance 46
 - Buttonhole slit width 46
 - Manual buttonhole 46
 - Personal memory permanent 46
 - Programming buttonhole length 46
 - Reset 46
 - Stitch counter buttonhole 46
- Functions combi mode** 48-51
- Adjusting length in combination 50
 - Adjusting width in combination 50
 - Altering pattern length 48
 - Backstepping 48
 - Balance 48, 51
 - Balance BERNINA Dual Transport 48
 - Combination repeat 50
 - Combination subdivider (1) 49
 - Combination subdivider (2) 49
 - Connecting stitches 51
 - Deleting 48, 50, 51
 - Editing combination at cursor position 48

- Menu selection**
- Alphabets 40
 - Buttonholes 40
 - Decorative stitches 40
 - History 40
 - Personal Program/Memory 40
 - Practical stitches 40
 - Quilt stitches 40
 - Stitch pattern selection via numbers 40
- Metallic threads** 153
- Mirror image**
- left/right/down/up 42, 47, 48, 50, 51, 114, 115, 144, 147, 170, 171, 180, 191
- Monitoring**
- Lower thread indicator 60
 - Upper thread indicator 60
- Monitoring mirror** 11, 23, 157
- Motif colors**
- Adjusting the brightness of the colors 198
 - Altering thread brand 198
 - Changing the colors of the motif via the color wheel 197
 - Embroidering in one color 199
 - Reallocating 197
- Multifunction tool** 11, 25, 213, 216, 217
-
- ## N
- Needle**
- Changing 25
 - Double-, triple needle 26, 32
 - Embroidery needle 151, 153, 156
 - Guidelines 17
 - Holder 15, 24, 26
 - Important sewing information 16-18
 - Inserting/removing 25
 - Needle-thread-combination 17
 - Overview 18
 - Position 15, 39
 - Raise/lower 20, 128
 - Stop down/up 15, 39, 42, 128
 - Threading 24
- Needle threader** 15, 38
- Needle, thread and material** 16
- Needle-thread-combination** 17
-
- ## O
- Opening for darning hoop connection** 15
- Optional accessory**
- Connection 15
- Overlock**
- Double overlock 76
 - Knit 77
- Reinforced 77
 - Stitches 76, 77
 - Stretch 76
 - Vari 76
- Overview**
- Alphabets 134, 164, 177, 227-234, 249, 268
 - Buttonholes 94, 95, 221
 - Color display 176
 - Combination 144
 - Creative consultant 70
 - Decorative stitches 110, 221-226
 - Display 40-51, 163-176
 - Edit 170-172
 - Embroidery menu 174
 - Embroidery mode 162
 - Embroidery motifs 166, 167, 236-270
 - Function buttons 38, 39, 161
 - Functions alphabets 47
 - Functions buttonholes 46
 - Functions combi mode 48-51
 - Functions embroidery 174
 - Functions sewing 42-44
 - Main Display 40-41
 - Needle 18
 - Practical stitches 76, 77, 221
 - Quilt stitches 123, 225
 - Selction menu 175
 - Setup Display 52
 - Sewing computer 14-15
 - Sewing techniques 70
 - Tutorial 69
-
- ## P
- Pattern begin** 42
- Pattern repeat** 42, 47
- PC-connection** 15, 19
- Personal memory**
- Permanent 80
 - Return to basic settings 79
 - Temporary 79
- Personal program** 139-142
- Altering/overwriting stitch patterns 141
 - Creating personal Display 139
 - Deleting stitch patterns 142
 - Preparing stitch patterns 139
 - Preparing/programming stitch patterns 139, 140
 - Stitch pattern selection in personal program 140
- Personal settings** 60
- Pivotable Triple Spool Holder** 21
- Polyester thread** 16, 153
- Power cable**
- Connection 15, 19
- Practical stitches**
- Bartack program 77
 - Basting stitch 77, 91

• Blind stitch	76, 90
• Blind stitch narrow	77
• Chainstitch	77
• Cover stitch effect	77
• Darning manual/automatic/reinforced	85-87
• Darning program	86, 87
• Darning stitch	77
• Double overlock	76, 88
• Finished edge overlock	77
• Gathering stitch	76
• Honeycomb stitch	76
• Jersey stitch	76
• Knit overlock	77
• Large fly stitch	77
• Lycra stitch	77
• Overlock	77
• Practical stitches	74-91
• Reinforced darning program	87
• Reinforced overlock	77
• Running stitch	76
• Securing program	76, 91
• Selecting	78
• Sewn out zig-zag	76
• Simple darning program	77
• Single straight stitch	77
• Small fly stitch	77
• Straight stitch	76, 82
• Stretch overlock	76
• Stretch stitch	77
• Super stretch	76
• Three single straight stitches	77
• Triple straight stitch	76, 82
• Triple straight stitch with longstitch	77
• Triple zig-zag	76, 83
• Universal stitch	76
• Vari-overlock	76
• Zig-zag	76
Preparation	
• Embroidery	156-158
• Embroidery module	152
• Sewing computer	19-36
Presser foot	
• As guide	89
• Attaching/removing	27
• Basic setting	34
• Changing	27
• Display	40, 168
• Optional presser feet	33
• Overview	12
• Pressure	34, 40
• Raise/lower	21
• Saving	33
• Selection	33, 40
• Standard Accessory	12
Presser foot lifter	11, 15, 21, 121
Presser foot pressure	
• Display	34
• Increasing/loosening	34
• Saving	34

Q

Quick Reverse button	38
Quilt stitches	
• Blanket stitch	123
• Blanket stitch (dual)	123
• Blind stitch (narrow)	123
• Decorative quilt stitch variations	123
• Double blanket stitch	123
• Double Blanket stitch (dual)	123
• Feather stitch	123
• Feather stitch variations	123
• Handlook quilt stitch	123
• Overview	123
• Patchwork stitch/Straight stitch	123
• Quilt stitch, Straight stitch	123
• Quilting, securing program	123
• Quiltstich/Handlook stitch variations	123
• Satin stitch	123
• Stippling stitch	123
Quilting	
• Free-motion quilting	125
• Handlook quilt stitch	123, 124
• Stipple quilting	125
• With BSR	126-130

R

Rayon thread	16, 153
Rayon threads	16
Removing	
• Embroidery hoop	206
• Embroidery module	156
• Needle	25
• Presser foot	27
• Slide-on table	20
• Stitch plate	27
Reset	
• Back to basic settings	63
• Deleting user data	63

S

Safety Instructions	2-3
Satin stitch	88, 123, 155
Saving	
• Embroidery motifs	175, 202
• Presser foot pressure	34
• Stitch pattern combination	143
• Stitch patterns	42, 44, 46, 47, 112, 113
Scrolling	
• Functions	42, 170
• Right/left	41
Seam	
• Blind	90
• Edges	89
• Visible	90

- Seam guide** 11, 20
- Seam guide**
- As guide 89
- Seam ripper** 11, 98
- Securing** 49, 128
- Securing program** 39, 54, 76, 91, 123
- Security program**
- Needle 32, 40, 168
 - Saving 32
 - Stitch plate 32, 40, 168
- Selecting**
- Display color 60
 - Embroidery motifs 162, 164-167
 - Language 61
 - Stitch patterns 78
- Selecting language** 61
- Selection**
- Fit to screen 41
 - Scrolling right/left 41
 - Single and combi mode 41
 - Stitch Designer 41
- Selection menu**
- Add motif 175
 - Delete motif 175
 - Opening new motif 175
 - Save motif 175
- Service data** 67
- Setting**
- Confirming 42, 170
 - Deleting 40, 170
- Setup Program** 52-68
- Acoustic signals 52, 61, 129
 - Activating/Deactivating securing stitches 57, 58
 - Altering Embroidery speed control 57
 - Altering upper thread tension 53, 57
 - Automatic securing program 54
 - Automatic thread cutter and securing stitches 55
 - Basic setting 61, 63
 - Beeper for BSR 61, 129
 - Brightness 62
 - Brightness sewing light 62
 - Calibrating Automatic Buttonhole Foot No. 3A 64
 - Calibrating Display 62
 - Calibrating the embroidery hoop 57
 - Cleaning the thread clamp/Thread catcher 65
 - Cleaning/Update 61, 64, 65
 - Dealer details 67
 - Delete user data 63
 - Display color 60
 - Display settings 61, 62
 - Embroidery settings 52, 57-59
 - Fabric thickness 57
 - Information 61, 67
 - Language selection 61
 - Lifting presser foot 54
 - Lubricating sewing-/embroidery computer 64, 66
 - Monitoring 52, 60
 - Overview Display 52
 - Packing position 64, 66
 - Personal settings 52, 60
 - Presser foot in hover position 54
 - Presser foot position with needle stop down 55
 - Programming «Function»-buttons/
«Function»-icon 53, 54
 - Programming «Quick reverse»-button 55
 - Programming «Securing»-button 54
 - Programming the foot control 53, 56
 - Reset 63
 - Securing stitches when starting to sew 53
 - Service data 67
 - Sewing computer settings 52, 61-63
 - Sewing light 62
 - Sewing settings 52, 53-56
 - Sewing speed control 53
 - Thread cut 57, 58
 - Time 64, 66
 - Update 64
 - Updating sewing/embroidery computer 64
 - Version 67
 - Welcoming text 60
- Sewing**
- Accessory 11-13
 - Alphabets 134
 - Blind hem 76, 77, 90
 - Buttonhole 94-107
 - Combinations 143-149
 - Corners 93
 - Edges 89
 - Eyelets 109
 - Flat joining seam 92
 - Function buttons 38, 39
 - Hem visible 90
 - Quick reverse 15, 38, 55
 - Sewing on button 108
 - Sewing techniques 70
 - Zipper 84
- Sewing computer settings**
- Basic setting 61, 63
 - Calibrating Buttonhole foot No. 3A 64
 - Calibrating Display 61, 62
 - Cleaning the thread clamp/Thread catcher 65
 - Cleaning/Update 61, 64
 - Delete user data 63
 - Display settings 61, 62
 - Information 61, 67
 - Language selection 61
 - Lubricating sewing-/embroidery computer 64, 66
 - Packing position 64, 66
 - Sewing light 62
 - Time 64, 66
- Sewing corners** 93
- Sewing in reverse**
- Permanent 42, 44, 47, 48
- Sewing in the zipper** 84

System settings

- Creative consultant 40, 70
- Deleting settings 40
- eco 15, 40, 74
- Help 40, 71
- Home 40
- Setup Program 40, 52-68
- Tutorial 40, 69

T**Tapering****111-113**

- Altering angle 111
- Back 113
- Back to basic setting 112, 113
- Backstepping 112, 113
- Balance 112
- Balance BERNINA Dual Transport 112, 113
- Configuring the bead tapering 113
- Distorting stitch patterns 112, 113
- Manual setting the Length of Section 2 112, 113
- Pattern repeat 112
- Personal memory permanent 112, 113
- Programming 112
- Programming the length of section 2 112
- Programming the length of section 2 by Entering mm 112

Tension**30, 31, 40, 53, 57, 122, 168****Thread**

- Breakage 185, 209
- Breaks 125, 209, 212
- Embroidery threads 17, 30, 153
- Important embroidery information 153-155
- Important sewing information 16-18
- Needle-thread 17

Thread cut**54, 58, 59****Thread cutter**

- Automatic 15, 39, 54, 161
- Lower thread 23, 157
- On bobbin winder 15, 22
- On the head frame 15, 24

Thread cutter in hook opening**23****Thread guide****22, 24, 26, 28, 29****Thread guide**

- At the back 15, 24
- Bobbin case 23
- Eyelet 21, 22, 29

Thread tension

- Back to basic setting 30
- Embroidery motif 168
- Lower Thread 31
- Upper thread 30, 40, 53, 57

Thread, needle and material**16****Thread-Guide-and-Lubricating Unit****28-29****Threading**

- Thread guide 29

Threading the double needle**26****Threading the triple needle****26****Top stitching edges****89****Topstitching**

- Edges 89
- Narrow/wide 89

Topstitching outer edges**89****Touchscreen pen****11, 19****Triple straight stitch****76, 82****Triple zig-zag****76, 83****Troubleshooting**

- Troubleshooting 212-220

Tutorial**40, 69**

- BSR 69
- Buttonholes 69
- Embroidery 69
- Miscellaneous 69
- Needle 69
- Presser foot 69
- Presser foot lifter (FHS) 69
- Quilting 69
- Sewing techniques 69
- Thread/Threading 69
- Troubleshooting 69

Types of fabric**70****U****Underlay stitches****155****Update****64****Upper thread**

- Indicator 60
- Tension 30, 40, 53, 57, 168
- Threading 24, 38, 161

V**Virtual positioning****172****W****Welcoming text**

- Entry/correction 60

Z**Zoom**

- Minus 114, 170
- Plus 114, 170

Text

Herbert Stolz/Susanne Ribl

Graphics

www.sculpt.ch

Pictures

Patrice Heilmann, CH-Winterthur

Typesetting, Layout

Susanne Ribl

Copyright

2017 BERNINA International AG, CH-Steckborn



