

IMPORTANT SAFETY INSTRUCTIONS

When using an electrical appliance, basic safety precautions should always be followed, including the following:

Read all instructions before using this sewing computer.

When the sewing computer is not in use, it should be disconnected from the electricity supply by removing the plug from the outlet.

DANGER

To reduce risk of electrical shock:

1. An appliance should never be left unattended when plugged in.
2. Always unplug this sewing computer from the electric outlet immediately after using and before cleaning.

WARNING

To reduce the risk of burns, fire, electric shock or injury to persons:

1. Do not allow to be used as a toy. Close attention is necessary when this sewing computer is used by or near children and infirm persons.
2. Use this sewing computer only for its intended use as described in this manual. Use only attachments recommended by the manufacturer as contained in this manual.
3. Never operate this sewing computer if
 - it has a damaged cord or plug
 - it is not working properly
 - it has been dropped or damaged
 - it has fallen into waterReturn the sewing computer to the nearest authorized BERNINA dealer or service center for examination, repair, electrical or mechanical adjustment.
4. Never operate the sewing computer with any air openings blocked. Keep ventilation openings of the sewing computer and foot controller free from accumulation of lint, dust and loose cloth.
5. Keep fingers away from all moving parts. Special care is required around the sewing needle.
6. Always use the BERNINA original stitch plate. The wrong plate can cause the needle to break.
7. Do not use bent needles.
8. Do not pull or push fabric while stitching. It may deflect the needle, causing it to break.
9. Turn power switch to «0» (off) when making any adjustments in the needle area, such as threading or changing the needle, threading the bobbin or changing the presser foot etc.
10. Always unplug the sewing computer from the electrical outlet when removing covers, lubricating or when making any other user servicing adjustments mentioned in this instruction manual.
11. Never drop or insert any object into any opening.
12. Do not use outdoors.

13. Do not operate where aerosol (spray) products are being used or where oxygen is being administered.
14. To disconnect, turn all controls to the off («0») position then remove the plug from the outlet.
15. Do not unplug by pulling on the cord but grasp the plug before pulling.
16. No responsibility will be taken for any possible damage as the result of misuse of the sewing computer.
17. This sewing computer is provided with double insulation.
Use only identical replacement parts. See instructions for Servicing of double-insulated machines.
18. Under no circumstances should the sewing computer be left unattended when using the embroidery module.

SERVICING DOUBLE-INSULATED PRODUCTS

In a double-insulated product, two systems of insulation are provided instead of grounding. No grounding means is provided on a double-insulated product nor should a means for grounding be added to the product. Servicing a double-insulated product requires extreme care and knowledge of the system and should only be done by qualified service personnel. Replacement parts for a double-insulated product must be identical to those parts in the product. A double insulated product is marked with the words «DOUBLE INSULATION» or «DOUBLE INSULATED».

The symbol  may also be marked on the product.

This sewing and embroidery computer is intended for household use only.

! SAVE THESE INSTRUCTIONS

artista 730

Dear artista customer

Congratulations! With the purchase of the **artista 730**, you have acquired the ultimate sewing and embroidery system available in today's market. By purchasing this system, you established that you are a creative person who is looking for the opportunity to expand the limits of creativity.

The use of modern, future-oriented technologies in the computerized sewing and embroidery field offer you heretofore **unheard of creative growth opportunities** while pursuing your hobby. This system encompasses not only BERNINA® hard- and software products, it also offers you a direct connection to myartista Portal, which can keep you in constant contact with the sewing and embroidery world.

BERNINA® wants you to fully enjoy the enormous possibilities the **artista computerized sewing system** offers you. To do so, you must know the product. Therefore, don't hesitate to frequent your local BERNINA® dealer and tap the knowledge of the BERNINA® educators.

I wish you much happiness and great satisfaction while enjoying your creative pastime.



H.P. Ueltschi
President
BERNINA Sewing Machine Manufacturers
CH-8266 Steckborn
www.bernina.com

Discover your creative wings.

BERNINA®

Masthead

artista 730

Sewing and Embroidery Computer Instruction Manual

Text / Sewing and Embroidery projects

Susanne Festi, Franziska Kiener, Herbert Stolz, Anna Tiberini

Photography

Ben Wiesenfarth, Konstanz: S. 8, 9, Dividers Sewing/Embroidery

Drawings

Müller-Melzer ID, Kreuzlingen

Bitmaps

Herbert Stolz, Steckborn

Design concept

Silvia Bartholdi, Schaffhausen

Inside cover (U2/U3)

Marlis Bennett, USA

Typesetting, layout, DTP

Silvia Bartholdi, Roswitha Taubert

Print

Heer Druck AG, Sulgen

Copyright

© 2005 by BERNINA, Steckborn

All rights reserved.

In order to improve the product, and for our customers' benefit, all of the sewing and embroidery computer's features, parts, and accessories are subject to unannounced changes and alterations at any time.

Summary of the Contents

	Safety Instructions	1
	Foreword	3
Sewing	The Sewing Computer	7
	Practical Stitches	35
	Decorative Stitches	73
	Lettering	97
	Buttonholes	109
	Quilt Stitches	135
	Personal Program	153
	Saving and Deleting Stitches and Stitch Combinations	157
	Setup Program	163
	Sewing and Sewing Computer Support	177
	Connecting Peripherals	191
Embroidery	The Embroidery Computer	195
	Important Embroidery Information	215
	Embroidery	223
	Saving and Deleting Motifs	247
	Embroidery Support	253
	Peripherals and Accessories	259
	Glossary	265
Stitch Summary	268	
Embroidery Design Collection	274	
Index	279	

Sewing – Content

The Sewing Computer

7–34

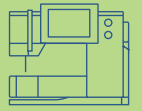

Practical Stitches

35–72



Decorative Stitches

73–96



Lettering

97–108



Buttonholes

109–134



Quilt Stitches

135–152



Personal Program

153–156



Saving and Deleting Stitches and Stitch Combinations

157–162



Setup Program

163–176



Sewing and Sewing Computer Support

177–190

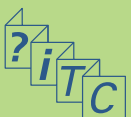

Connecting Peripherals

191–194





Setting up the Sewing Computer **8**

Operating Instructions **11**

Screen Display **23**

External Functions **28**

On-screen Functions **29**

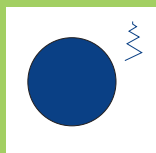
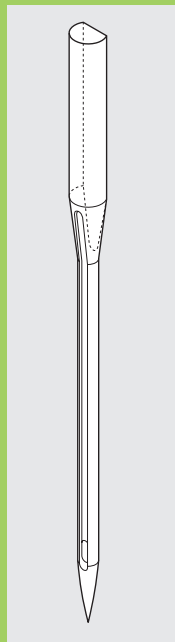
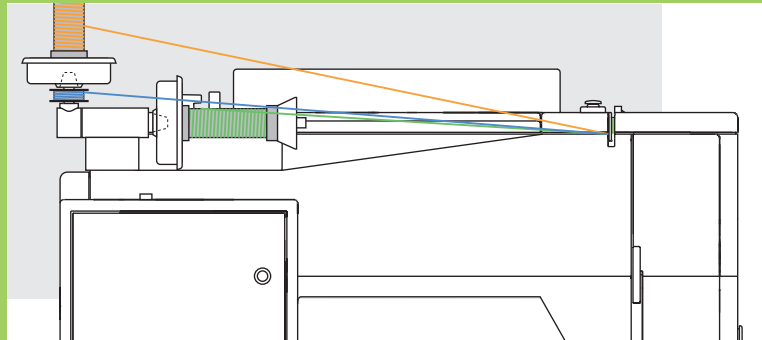

The Sewing Computer

Details of the Sewing Computer

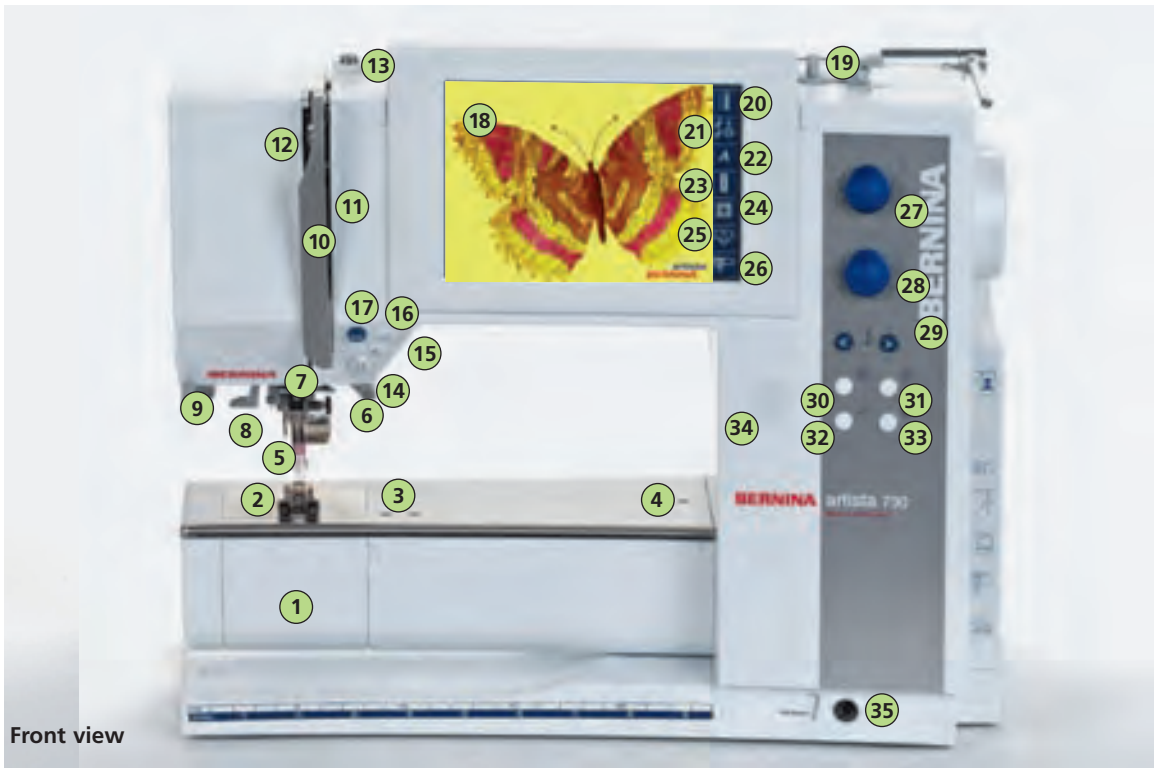
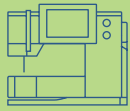

Setting up the Sewing Computer





Side view (head frame)



Side view (handwheel)

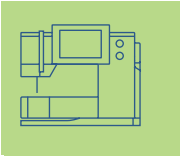

- 1 Bobbin cover
- 2 Stitch plate
- 3 Attachment base for special accessories
- 4 Darning hoop connection
- 5 Presser foot
- 6 Needle clamp
- 7 Thread guide
- 8 Needle threader
- 9 Magnifying glass holder
- 10 Thread take-up cover
- 11 Thread path
- 12 Thread take-up
- 13 Bobbin pre-tension
- 14 Quick reverse button
- 15 Pattern end
- 16 Favorite function button (programmable via Setup button)
- 17 Automatic thread cutter
- 18 Screen
- 19 Bobbin winder with on/off switch and thread cutter
- 20 Practical stitch button
- 21 Decorative stitch button (16/4 directions)
- 22 Alphabet button
- 23 Buttonhole button
- 24 Quilt stitches button
- 25 Personal program button
- 26 Sewing mode/Embroidery mode button
- 27 Stitch width knob
- 28 Stitch length knob
- 29 Needle position buttons
- 30 Creative consultant button
- 31 Tutorial button
- 32 «clr» (clear) button
- 33 Setup button
- 34 Speaker
- 35 FHS (Free Hand System) connection
- 36 Carrying handle
- 37 Horizontal spool pin
- 38 Presser foot lifter
- 39 Slide-on table socket
- 40 Presser foot pressure dial
- 41 Thread cutter on head frame
- 42 Thread guide (while winding the bobbin when sewing and embroidering)
- 43 Spool pin (vertical, collapsible)
- 44 Handwheel
- 45 Card slot for BERNINA Modem (optional accessory), Personal design cards and Embroidery cards (optional accessories)
- 46 Headset connection (optional accessory)
- 47 Connection for USB Stick
- 48 PC connection
- 49 Embroidery module connection (for optional accessory)
- 50 Foot control socket
- 51 Drop feed dog
- 52 Power switch on/off («0»)
- 53 Power plug socket

Accessories*

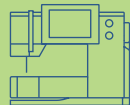

The following accessories are arranged separately in the styrofoam packing or later in the suitcase system (special accessory):

- foot control
- instruction manual
- power cable
- warranty card
- FHS presser foot lifter (Free Hand System)
- slide-on table
- seam guide for slide-on table
- Seasons of Artistry
- Instructional / Presentation CD-ROM
- Design / Tutorial USB-Stick
- BSR System
- Carrier Bag
- Touch Screen Stylo

• for more information for Instructional / Presentation CD-ROM see page 194



Carrier Bag

- protects from dust and dirt
- ❖ this bag can be used to transport the sewing computer. The accessories can be stored in the corresponding compartments

Accessory Box



Storing Accessories

- ❖ set up the free standing accessory box by pulling both extensions out until they click into place

Both accessory boxes are equipped with one small and one large drawer each as well as two compartments for bobbins, two compartments for coded presser feet and one compartment for non-coded presser feet.

The compartments can be stored in the box (additional compartments and drawers are available as optional extras).

- ❖ insert the bobbins into the compartments provided
- ❖ to remove a bobbin, press the compartment holder **A** lightly
- ❖ hang presser feet in the compartments provided
- ❖ store the remaining accessories as shown in the picture

Suitcase System (special accessory)

The suitcase system is specially built for your sewing and embroidery computer and has integrated wheels. This allows your system to be transported easily and elegantly.

• for more information see page 262

Standard Accessories*

- four bobbins (+ one in bobbin case)
- selection of 130/705 H needles
- seam ripper
- small screwdriver
- angular Torx key
- lint brush
- seam guide
- 2 foam pads
- Reverse pattern foot No. 1C
- Overlock foot No. 2A
- Buttonhole foot with code No. 3C
- Automatic buttonhole foot No. 3A
- Zipper foot No. 4
- Blind stitch foot No. 5
- Jeans foot No. 8
- Button sew-on foot No. 18
- Open embroidery foot No. 20C
- Sideways motion foot No. 40C
- Compensation plate for sewing buttonholes
- height compensating tool
- three spool discs
- oiler
- USB Cable

*(can vary from country to country)

Setting up the Sewing Computer

Power Cable



Power Cable

- ❖ plug **A** into sewing computer
- ❖ plug **B** into electrical outlet

Foot Control Cable

- ❖ plug **C** into sewing computer (look for symbol)

Foot Control

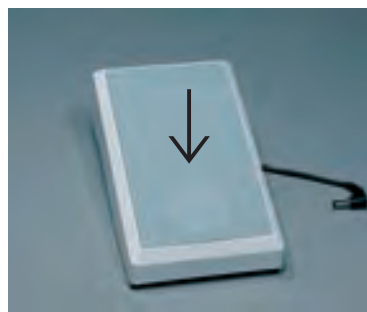

Sewing Speed

- control the sewing speed by depressing the foot control
- raise or lower the needle by tapping on the foot control with your heel

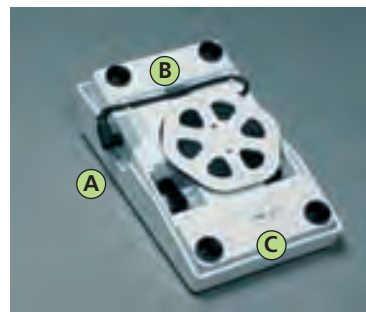

Cable Tidy

- ❖ wind the cable around the spool
- ❖ insert the plug into **A**

When Sewing

- ❖ unwind the cable to the desired length and slip into **B** or **C**

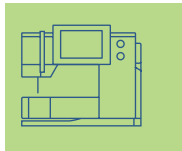

Important! (USA/Canada only)

Use only foot controller type LV1 for sewing computer model **artista 730**.

Operating Instructions

Power Switch



! Refer to the safety instructions!

Important! (USA/Canada only)

This sewing computer has a polarized plug (one blade wider than the other). To reduce risk of electrical shock, this plug is intended to fit only one way into a polarized outlet. If the plug does not fit fully in the outlet, reverse the plug. If it still does not fit, contact a qualified electrician to install the proper outlet. Do not modify the plug in any way.

Power Switch

The power switch is on the handwheel side of the sewing computer.

1 the sewing computer is switched on («1»)

0 the sewing computer is switched off («0»)

The sewing light is switched on and off with the power switch.

FHS (Free Hand System) Presser Foot Lifter



Raising and Lowering the Presser Foot

- ❖ the presser foot lifter raises and lowers the presser foot
- ❖ push to the right with your knee
- ❖ the presser foot is raised and the feed dog is lowered simultaneously
- ❖ the feed dog comes up automatically as soon as the first stitch is sewn

Attaching the Free Hand System

- ❖ insert the free hand system into the opening in the base plate
- ❖ you should be able to operate the FHS in your normal sitting position with your knee

Note:
Your dealer can adjust the position of the FHS if necessary.

Slide-on Table

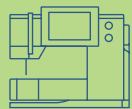

Slide-on Table

- the slide-on table increases the sewing surface
- free arm for larger tubular items such as pant legs and waistbands

To Attach

- ❖ needle and presser foot fully raised
- ❖ slide over free arm to the right until it engages

To remove

- ❖ needle and presser foot fully raised
- ❖ pull to the left
- ❖ remove by pulling it completely from the free arm

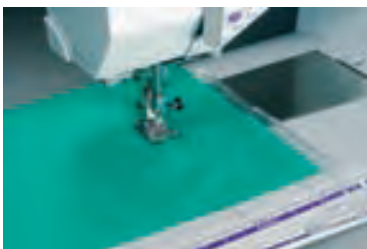

Seam Guide

- ❖ insert into the groove (underside of table) from the right or left
- it can be freely adjusted over the whole width of the table

Scale

number «0» on the slide-on table corresponds to the center needle position

Screen



The artista 730 is operated with a combination of external buttons and knobs and a touch screen.

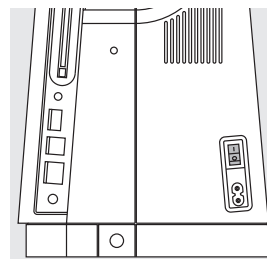

Welcome Screen

- ❖ switch sewing computer on: power switch to «1» (on)
- Welcome screen appears for a few seconds
- can be personalized in the Setup Program

Practical Stitch Screen

After the Welcome the Practical Stitch screen appears automatically on the screen, which shows:

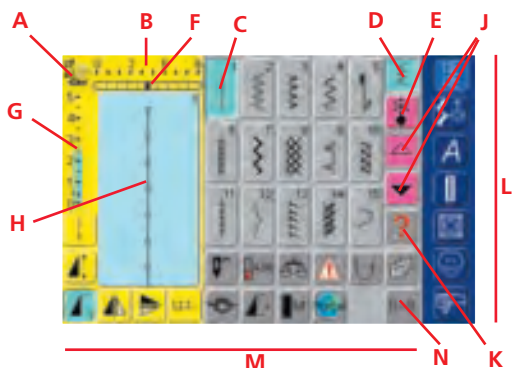

- A** Presser Foot Indicator
- B** Stitch width (basic setting always visible)
- C** Selected, active stitch and number
- D** Single Mode
- E** Combi Mode
- F** Needle Position (11 possibilities)
- G** Stitch length (basic setting always visible)
- H** Picture of selected, active stitch and number (Stitch Altering Area)
- J** Up/down scroll arrows
- K** Help symbol
- L** Main category buttons
- M** Functions
- N** Stitch Selection by Number

Winding the Bobbin

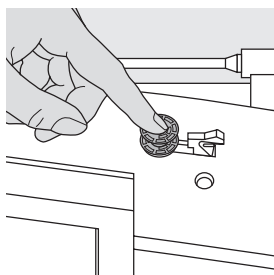

Winding the Bobbin

- ❖ turn power switch to «1» (on)
- ❖ place empty bobbin on spindle

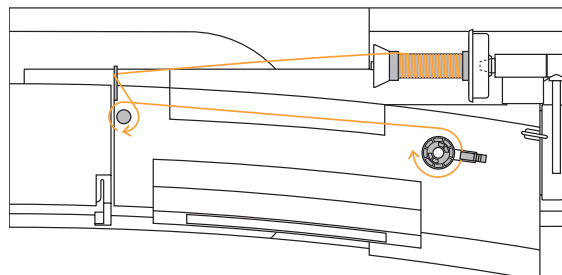

Threading the Bobbin

- ❖ place thread on spool pin
- ❖ attach appropriate spool disc - diameter of spool disc is disc size
- ❖ following the direction of the arrow take thread through the rear guide and around the pretension stud
- ❖ wrap the thread around the inner bobbin two or three times and cut off any excess thread on the thread cutter
- ❖ press the engaging lever against the bobbin
 - the bobbin winder works automatically
 - the motor stops automatically when the bobbin is full
- ❖ remove the bobbin

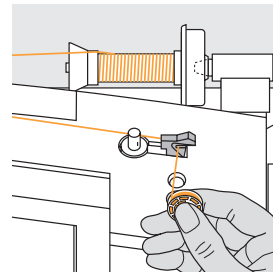

Thread Cutter

- ❖ cut the thread on the thread cutter

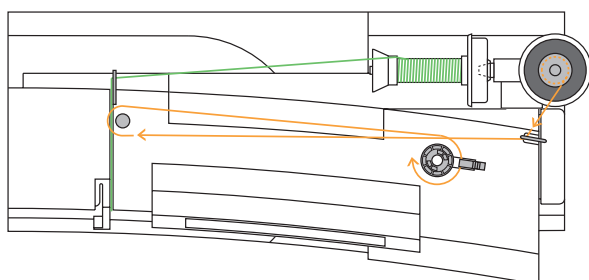
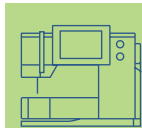

Winding the Bobbin While Sewing or Embroidering

- ❖ place thread spool on vertical spool then, following the direction of the arrow, take thread through the thread guide on head frame and around the pretension stud
- ❖ follow the instructions as described above for the next steps of winding the bobbin

Bobbin Case

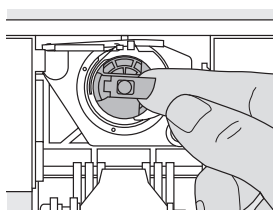

To Remove

- ❖ raise the needle
- ❖ turn power switch to «0» (off)
- ❖ open the bobbin cover
- ❖ grasp the latch of the bobbin case with right hand
- ❖ remove case

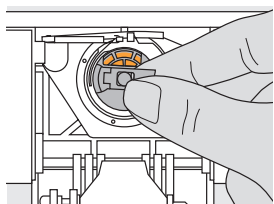

To Insert

- ❖ hold the bobbin case latch
 - the opening on the case should be at the top
- ❖ insert bobbin case so that it engages
- ❖ close the bobbin cover

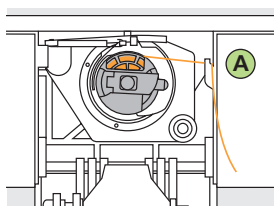

Bobbin Thread Cutter

- ❖ insert the bobbin case
- ❖ take the thread over cutter **A** and cut the thread

Caution!

Moving parts – To reduce risk of injury, switch to «0» (off) before servicing. Close bobbin cover.

Note:

For normal sewing, the bobbin thread does not have to be brought up as the loose end is just the right length to start sewing.

• to insert bobbin see page 14

Inserting the Bobbin

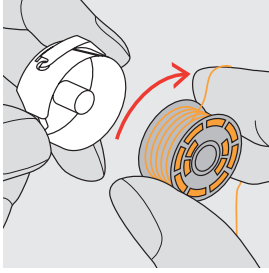

Inserting the Bobbin

- ❖ insert the bobbin so that the thread runs clockwise

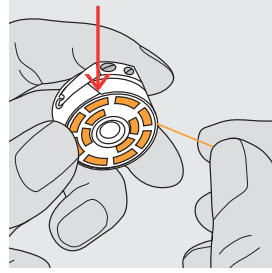

Pulling the Thread Into the Slot

- ❖ pull the thread counter clockwise into the slot

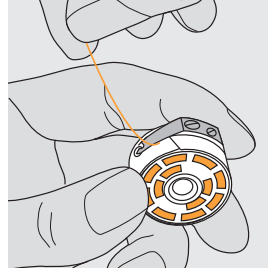

Pulling the Thread Under the Spring

- ❖ pull the thread to the left under the spring until it lies in the T-shaped slit at the end of the spring

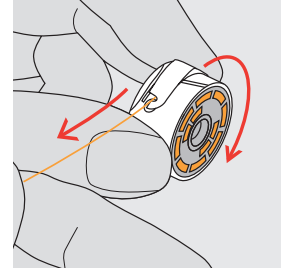

Clockwise Turning of the Bobbin

- the bobbin must turn clockwise when the thread is pulled

Threading the Upper Thread

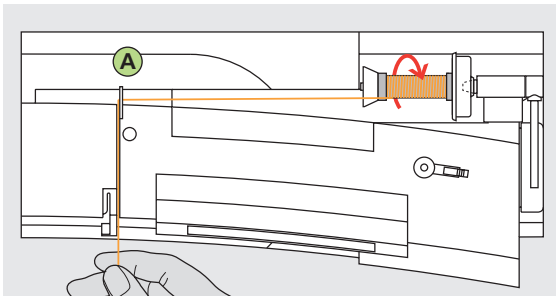

Attaching the Thread Spool

- ❖ raise the needle and presser foot
- ❖ turn the power switch to «0» (off)
- ❖ attach the foam pad
- ❖ place spool on pin (thread winds clockwise)
- ❖ attach the appropriate spool disc - diameter of spool determines disc size. There must be no clearance between the disc and the spool
- ❖ take thread through rear guide **A**
- ❖ then into slit of upper thread tension

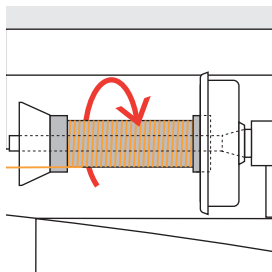
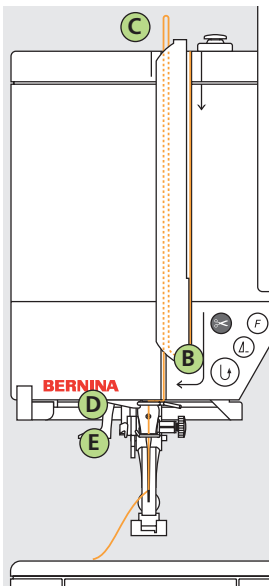

Down

- ❖ pull thread down to the right of the take-up cover to **B**

Up

- ❖ take thread up to the left of the cover to **C** in the direction of the arrow, placing it in the take-up lever

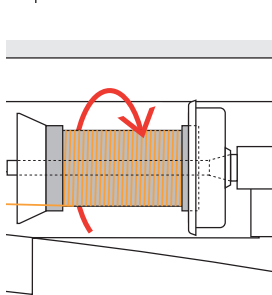

Down

- ❖ take thread down and through guides **D** and **E**

! Refer to the safety instructions!

Needle Threader

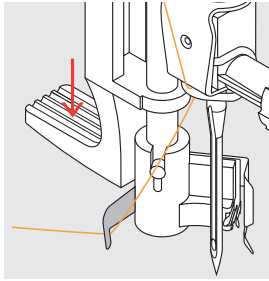

Thread in Hook

- ❖ lower the presser foot
- ❖ lay the thread behind hook **B** and hold lightly

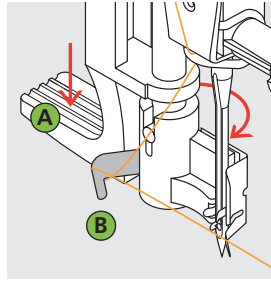

Lever Down

- ❖ press lever **A** down and simultaneously guide the thread around hook **B** to the right to the needle

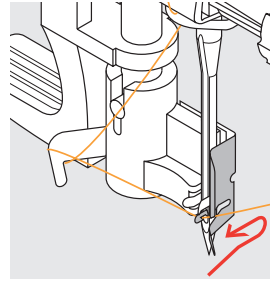

Thread in Front of Needle

- ❖ put the thread from the front into the guide until it catches in the hook

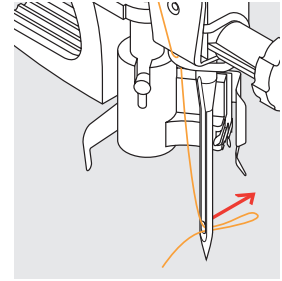

Release the Lever and Thread

- ❖ let go of lever **A** and thread
- ❖ pull the thread loop through the needle eye

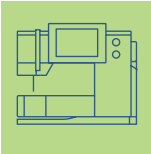

Bringing up the Lower Thread

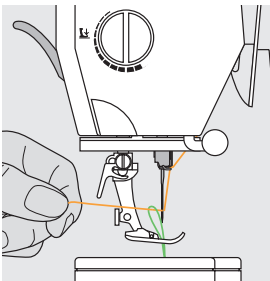

- if bobbin thread is cut on the cutter (page 13), there is no need to bring the thread to the top of the stitch plate
- ❖ hold the upper thread
- ❖ sew one stitch:
 - normal sewing with presser foot down
 - by tapping on foot control with your heel, with presser foot up
- ❖ pull the upper thread to bring the lower thread up through the stitch plate hole
- ❖ take both threads through the slit on the presser foot to the back
- ❖ pull threads over the head frame cutter

Thread Cutter

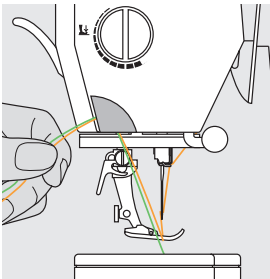

Thread Cutter on Head Frame

- ❖ pull both threads from front to back over the cutter
 - the threads release as soon as the first stitch is sewn

Note:

The bobbin thread must be brought up through the stitch plate for certain types of work. The length of thread is sufficient for most normal work if the lower thread cutter has been used.

Changing the Needle

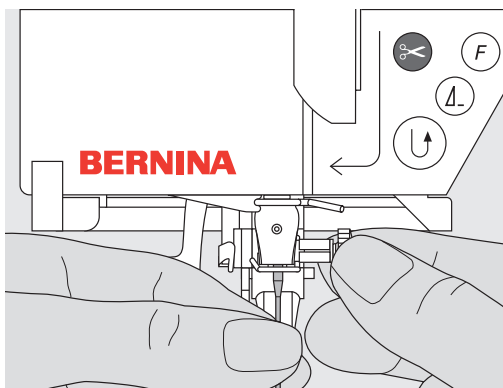

Removing the Needle

- ❖ raise the needle
- ❖ turn power switch to «0» (off)
- ❖ lower the presser foot
- ❖ loosen the needle clamp screw
- ❖ pull the needle down to remove

Inserting the Needle

- ❖ loosen the needle clamp screw, if needed
- ❖ flat side of needle to the back
- ❖ insert the needle as far up as it will go
- ❖ tighten the needle clamp screw

! Refer to the safety instructions!

Spool Pin (vertical)

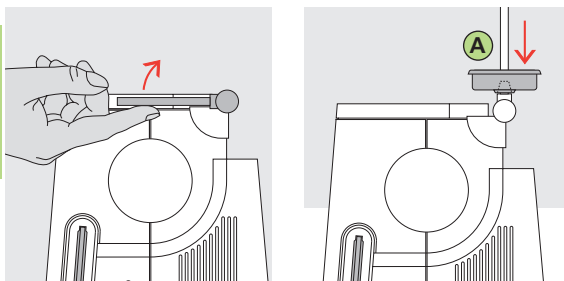
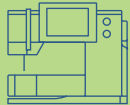

Collapsible vertical spool pin

- found at the right of the horizontal spool holder
- essential sewing aid when using more than one thread, i.e. double needle, etc.
- ❖ for sewing, turn the spool holder upwards until it is in the upright position
- ❖ add the foam pad **A** for stability, this prevents from caught on the spool pin

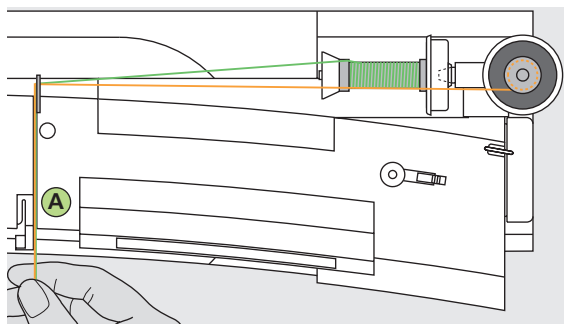

Threading the Double Needle

1. Threading the First Thread

- ❖ place thread spool on horizontal spool pin
- ❖ thread by guiding the thread to the front in the slit and past the tension disc **A** on the right side
- ❖ thread sewing computer as usual, but at the thread guide **B** guide the thread through on the right side and thread the right needle

2. Threading the Second Thread

- ❖ place thread spool on the additional spool pin
- ❖ thread by guiding the thread to the front in the slit and past the tension disc **A** on the left side
- ❖ guide thread on the left side of the thread guide **B** and thread the left needle
- threads must not be twisted together

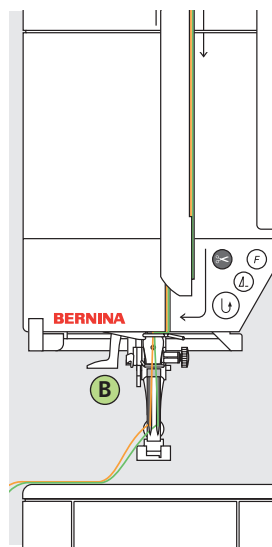

Note:

When using the supplementary spool pin (vertical) always attach the foam pad (prevents the thread from getting caught on the spool pin)

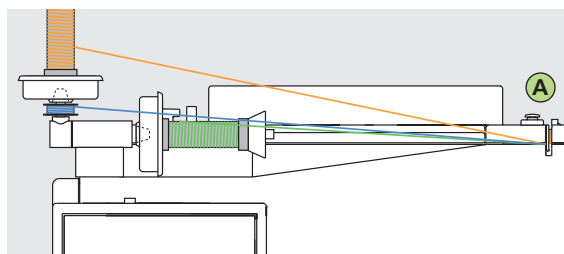

Threading the Triple Needle

- two thread spools and one full bobbin are needed
- ❖ place one thread spool on horizontal spool pin
- ❖ place second thread spool and the lower thread spool, on additional spool pin (both spools have to turn in the same direction)
- ❖ thread as usual by guiding two threads on the left side of the tension disc **A** and the thread guide **B** and one thread on the right side of disc

Stitch Plate

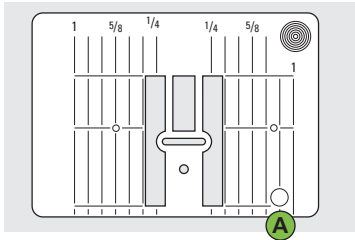

9 mm (inch measurements)

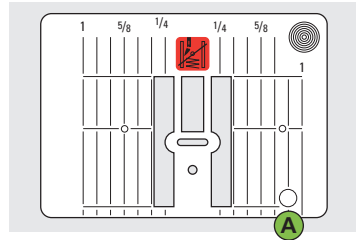

5.5mm Stitch Plate
(special accessory)

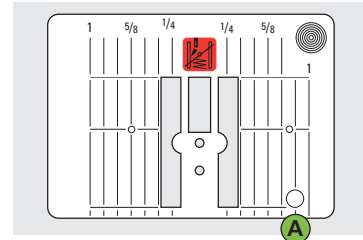

Straight Stitch Plate
(special accessory)

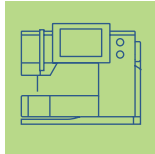

Stitch Plate Markings

- the stitch plates are marked with vertical lines in millimeters or inches
- mm measurements are at the front
- inch measurements are at the back
- the measurements correspond to the distance from the needle to the line
- needle insertion point is position 0 (center needle position)
- the mm/inch measurements are marked to the right and left
- the lines help to guide the fabric for sewing seams and for topstitching
- the horizontal markings are helpful for sewing corners and buttonholes, etc.

Removing the Stitch Plate

- turn power switch off («0»)
- raise the presser foot and needle
- lower feed dog
- press the stitch plate down at the back right corner until it flips up
- remove the stitch plate

Replacing the Stitch Plate

- place the stitch plate over the opening **A** and press down until it clicks into place

Note:

As in all household appliances because of the motors and electronics, your artista 730 will get warm when in use. This is a normal occurrence.

Important Facts About Thread and Needles

With the right combination of thread and needle optimum sewing results are achieved.

Thread

The thread is chosen according to use. For a perfect sewing result, thread and material quality play an important role.

Cotton Thread

- cotton thread has the advantage of a natural fiber and therefore is especially suitable for sewing cotton fabrics
- if cotton thread is mercerized it will have a slight sheen

Polyester Thread

- polyester thread is suitable for practically all sewing needs
- it has a high tensile strength and is particularly colorfast
- polyester thread is more flexible and is recommended where a strong and elastic seam is required

Needle, Thread and Fabric

Care has to be taken when combining needle and thread.

The correct needle size does not only depend on the chosen thread, but also has to be well suited to the fabric used. The fabric weight determines the thread weight and needle size and point form.

The following are the guidelines:	Needle No.
• fine fabrics: fine thread (darning thread, embroidery thread)	70–75
• mediumweight fabrics: normal thread	80–90
• heavyweight fabrics: stronger thread	100, 110, 120

Needle/Thread Combination

In order to check the needle/thread compatibility, the correct size thread must correspond with the correct size needle.

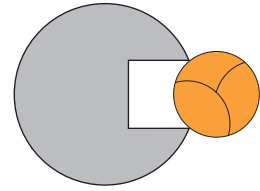
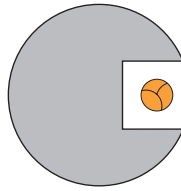
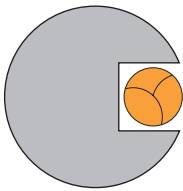
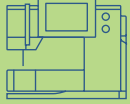

Correct Needle/Thread Combination

When sewing, the thread should travel smoothly down the long groove on the front of the needle. The thread can be secured optimally.

Too Thin Thread or Too Thick Needle

The thread does not travel smoothly in the groove. Faulty stitches and damage of the thread can occur.

Too Thick Thread or Too Fine Needle

The thread rubs on the edges of the groove and can get jammed. This can break the thread.

Needle Summary

BERNINA uses needle system 130/705 H. This system number refers to shank shape as well as to length and form of the needle point.

130/705 H S 70

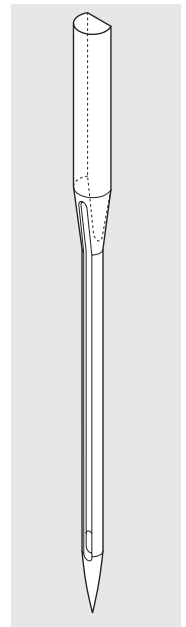
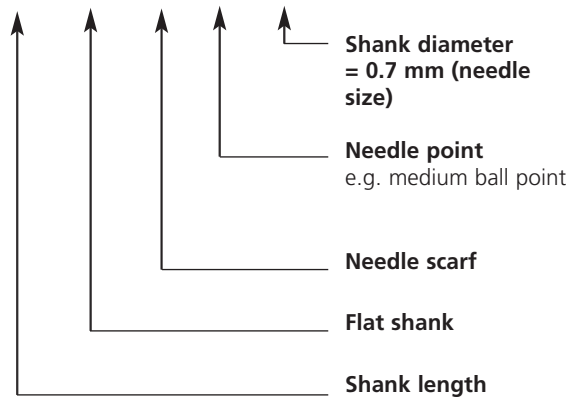

Checking the Needle Condition









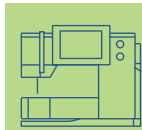



The needle condition should be checked and the needle replaced regularly. A defective needle not only damages the sewing but also the sewing computer.

The following are the guidelines: replace needle when starting a new sewing project or as required.

• more about this subject see «Trouble Shooting» on page 186 ●●●●●●●●●●

Many materials are easier to sew if the appropriate needle is used.



Type of needle	Model	Suitable for	Needle size
Universal 130/705 H	 Normal point, slightly rounded	For nearly all natural and synthetic fabrics (woven and knitted)	60–100
Jersey/Stretch 130/705 H-S 130/705 H-SES 130/705 H-SUK	 Ball point	Jersey, stretch fabrics	70–90
Leather 130/705 H-LL 130/705 H-LR	 Cutting point	Natural and synthetic leather and plastic	90–100
Jeans 130/705 H-J	 Very fine point	Heavyweight fabrics such as denim, canvas, overalls	80–110
Microtex 130/705 H-M	 Especially fine point	Micro fiber fabrics and silk	60–90
Quilting 130/705 H-Q	 Fine point	Straight and topstitching	75–90
Embroidery 130/705 H-E	 Large eye, slight ball point	Embroidery on all natural and synthetic fabrics	75–90
Metafil 130/705 H-MET	 Large eye	Sewing with metallic threads	75-90
Cordonnet 130/705 H-N	 Small ball point, long eye	Topstitching with thick thread	80–100
Wing needle 130/705 HO	 Wide needle (wing)	Hemstitching	100–120
Double wing needle 130/705 H-ZWI-HO		Special effects with hemstitch embroidery	100
Double needle 130/705 H-ZWI	 Needle distance: 1.0 / 1.6 / 2.0 / 2.5 / 3.0 / 4.0 / 6.0 / 8.0	Visible hems in stretch fabrics, pintucks, decorative sewing	70–100
Triple needle 130/705 H-DRI	 Needle distance 3.0	Decorative sewing	80

Special needles are available at your BERNINA dealer.

Presser Feet

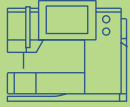

Note: The letter «C» after a foot number indicates the foot is coded or equipped with a sensor for 9mm stitching. When a stitch is selected with a coded foot attached to the sewing computer, the preprogrammed width is 9mm, rather than 5.5mm.



1C
Reverse pattern foot
Practical and decorative stitches



2A
Overlock foot
Overlock seams, oversewing seam edges



3C
Buttonhole foot with code
Buttonholes (shows as foot No. 3C on-screen)



3A
Automatic buttonhole foot
Buttonholes in flat materials
Darning program (shows as foot No. 3A on-screen)



4
Zipper foot
Sewing in zippers



5
Blind stitch foot
Blind hems
Edge stitching

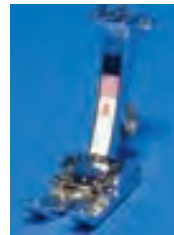

8
Jeans foot
Straight stitching in thick, firm fabrics



18
Button sew-on foot
Sewing on buttons, hooks and eyes



20C
Open embroidery foot
Embroidery, appliqué, satin stitch seams, monograms



40C
Sideways motion foot
For all sideways motion stitches

BERNINA Specialty Presser Feet

The standard selection of presser feet covers most normal sewing requirements, but we recommend the use of BERNINA specialty presser feet for specific sewing tasks such as quilting, heirloom sewing, home decorating, tailoring, etc.

They are available from your BERNINA dealer.

Samples of Specialty Presser Feet



50
Walking foot
For fabrics which stick or tend to slip and for quilting



9
Darning foot
Used with the feed dog in a lowered position for darning, monograms, and freehand embroidery

Changing the Presser Foot

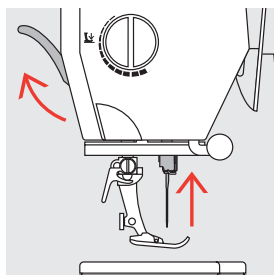

Changing the Presser Foot

- ❖ raise the needle and presser foot
- ❖ turn power switch to «0» (off)

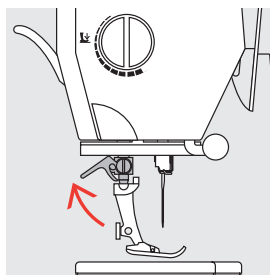

Raising the Lever

- ❖ raise the clamping lever
- ❖ remove the presser foot

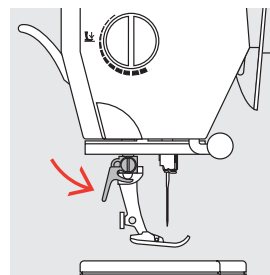

Attaching the Presser Foot

- ❖ guide the foot upwards over the cone
- ❖ press the clamping lever down

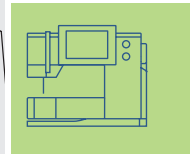

! Refer to the safety instructions!

Presser Foot Pressure

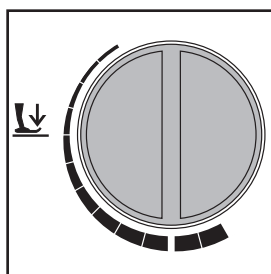
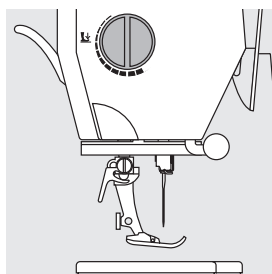

Standard Pressure

- for all normal sewing

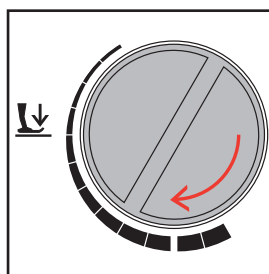

Reduced Pressure

- for jerseys and loose knits, quilting
- prevents fabric from stretching
- ❖ adjust pressure so that the fabric still feeds correctly

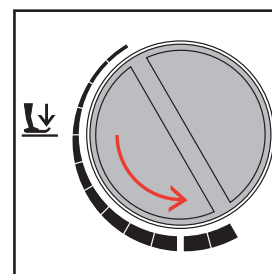

Increased Pressure

- for firm fabrics; improves fabric feed

Dial on Head Frame

The presser foot pressure can be set on the left of the head frame.

Feed Dog

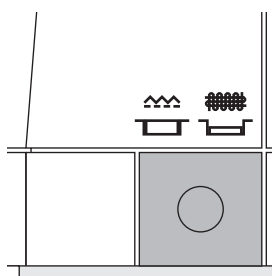

Button on Handwheel Side of Sewing Computer

Button flush with base plate = feed dog up, sewing position

- for all machine-fed sewing



Button depressed = feed dog lowered, darning position

- for freehand sewing (darning, freehand embroidery, freehand quilting)
- for embroidery (with the embroidery module)



Feed Dog and Fabric Feed

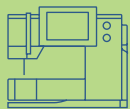

Feed Dog and Stitch Length

With each stitch the feed dog moves forward by one step. The length of this step is determined by the stitch length selected. With an extremely short stitch length, the steps are also very short. The fabric moves under the foot quite slowly, even at full sewing speed. Buttonholes, satin stitch and decorative stitches are all sewn with a very short stitch length.

Important

- let the fabric feed evenly!
- pulling, pushing or holding back the fabric will result in uneven stitches

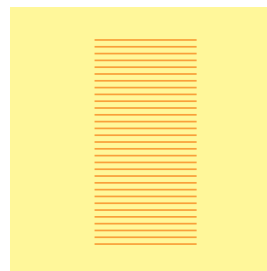

Height Compensating Tool

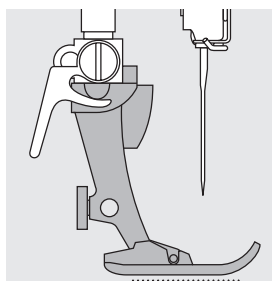

The feed dog can work normally when the foot is level.

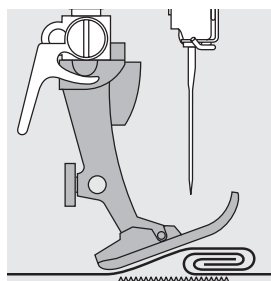

If the foot is at an angle, e.g. when sewing over thick to thin or vice versa, the feed dog cannot grip and feed the fabric.

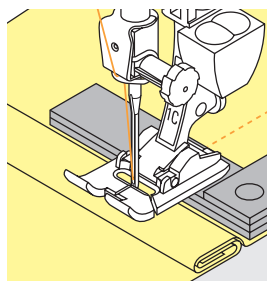

To solve this problem, place one, two or three compensating plates as required behind the needle under the presser foot.

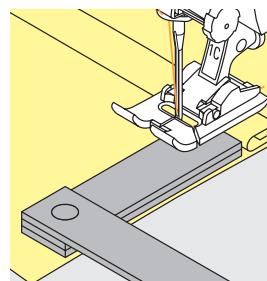

To correct the height in front of the foot, place one or more plates to the right of the foot next to the needle. Sew until the foot is level again and remove the plates.

Feed Dog and Sewing Corners

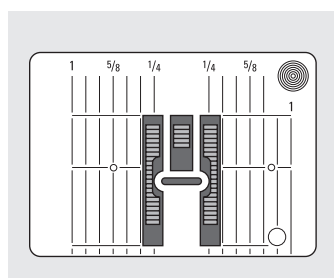

The gap between the two rows of teeth is relatively large due to the width of the stitch plate hole.

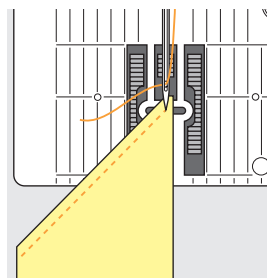

When sewing corners, only a small section of the fabric is actually on the feed dog so that it cannot grip the fabric well.

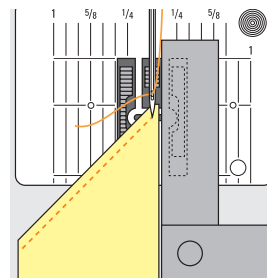

Correct this by placing one or more compensating plates as close as possible to the edge of the fabric.

Stitch Selection – Stitches – Functions



Stitch Selection

- ❖ touch the stitch of your choice
- the stitch is highlighted in blue
- every stitch in the Stitch Altering Area (SAA) is displayed with its number

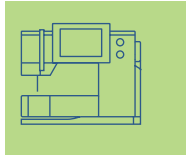

Screen Display

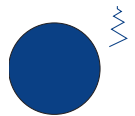

Altering the Stitch Width

- ❖ turn the upper knob

The altered stitch width is shown in two different ways:



- stitch width bar 0-9 (0-5.5) is displayed as yellow area
- altered width is visible on stitch width bar (highlighted in blue), in addition the actual setting is shown (blue number)
- the basic setting is always visible when a change has been made, e.g. 3.5mm (black bar)
- stitch width can be altered from 0mm to 9mm when using coded feet
- stitch width can be altered from 0 to 5.5mm max. when using non-coded feet, the stitch width bar automatically shows 0-5.5mm



Altering the Stitch Length

- ❖ turn the lower knob

The altered stitch length is shown in two different ways:



- stitch length bar 0-5 is displayed as yellow area
- altered length is visible on stitch length bar (highlighted in blue), in addition the actual setting is shown (blue number)
- the basic setting is always visible when a change has been made, e.g. 1.5mm (black bar)
- stitch length can be altered from 0mm to 5mm on most stitches

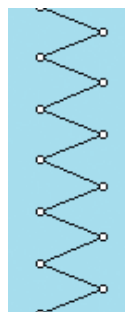

Display of Selected Stitch

- a graphic of the selected stitch is visible in the left portion of the screen
- changes to stitches can be seen on screen



Altering the Needle Position

- ❖ press the right or left Needle Position button
 - each press moves the needle one position to the right or left
- ❖ keep button pressed to quickly change needle positions
 - the middle position of the bar is marked in black
 - the basic setting (bordered in gray) is always visible



Presser Foot Indicator

- the recommended presser foot for the selected stitch is displayed by number
- by touching the Presser Foot symbol, further possible presser feet for the selected stitch will be displayed
- if the presser foot is raised it is indicated with an arrow



Temporary Altered Stitch Memory

Stitch length, stitch width, needle position, etc. are automatically saved. When the sewing computer is turned off («0») or the «clr» (clear) button is pressed, the changes are deleted.

Saving Altered Settings Permanently

The basic settings programmed by BERNINA can be changed and stored in the SAA. They will stay saved even after the sewing computer is turned off («0»). The basic settings are always visible.



clr

Restoring the Basic Settings

- ❖ touch the external button «clr» (clear)
 - the basic setting of the selected stitch will be restored
- ❖ clear by pressing small number on stitch width and stitch length bar



Selecting Functions

- ❖ touch the function of your choice
 - the selected function is highlighted in blue (a number of different functions can be selected simultaneously)

• for more information on Functions see pages 29-33

• for more information see page 39

Changing Settings (stitch width, stitch length, needle position, thread tension, etc.)

- ❖ select stitch for which you want to alter width, length and/or needle position (e.g. zig-zag)

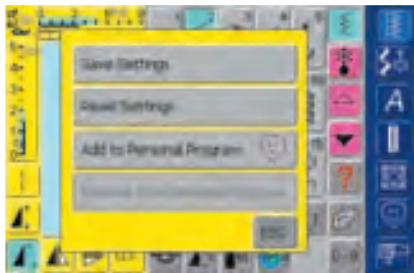

Changing Basic Settings

- ❖ alter the stitch width and length settings using the external knobs
- ❖ alter the needle position with the external buttons
- ❖ touch Stitch Altering Area (light blue)
 - a special screen opens
- ❖ touch «Save Settings» = all changes are saved
- ❖ touch «Reset Settings» to return to basic settings
- ❖ touch «ESC» and the screen closes without anything being saved or altered

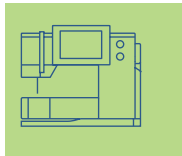

• for more information on the lower two bars see Personal Program on page 156

Stitch Selection

Stitches can be selected using one of the two methods listed below.

Note:

If an unavailable number is entered, the following message will appear: This number is not available in the sewing computer.



Direct Selection by Scrolling up/down Within a Stitch Category

- ❖ touch the arrow (down)
 - scroll the screen to view all stitches in selected category
 - the top row disappears
 - the next two rows move up
 - a new row appears at the bottom
- ❖ touch the arrow (up)
 - the first row of stitches appears again
- the Scroll function (up/down) is used to find and view all the sewing computer's stitches
- use when a visual search for a particular stitch is needed
- when the desired stitch is located, touch to select



Selecting a Stitch by Number

- ❖ touch the function «0-9»
- the screen changes to a numeric pad
- ❖ touch numbers to select the stitch of your choice
- the number of the selected stitch appears in the upper screen

Correcting Mistakes

- ❖ to correct mistakes or deselect, touch function top right (arrow)
 - the number is deleted from right to left
- ❖ touch the field above the numeric pad
 - the entire number is deleted
- ❖ enter new number



Confirm and Go to Next Screen

- ❖ touch «OK» to confirm
- the screen displays the selected stitch
- the selected stitch is active (highlighted in blue)

Back to Previous Screen

- ❖ touch «ESC»
 - the previous screen appears
- if the selection was not confirmed by touching «OK», the stitch selected by number will be ignored

Simple Menu Selection

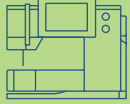

Main Category Buttons

- ❖ press a button to select the desired menu
- the selected category is directly accessed
- the stitch patterns or an overview appear

Practical Stitches

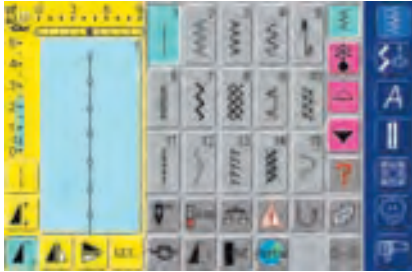

Practical Stitch Button

- the Practical Stitch menu appears
- 15 practical stitches appear on the screen
- use arrows to scroll for viewing additional stitches

Decorative Stitches 16/4 Directions



Decorative Stitch Button, 16/4 Directions

- the Decorative Stitch menu appears
- 6 categories appear on screen
- use arrows to scroll for viewing additional groups
- different stitch types and sizes can be selected
- sideways motion stitches are indicated with 4 arrows
- ❖ touch to select the desired stitch group
- the selected stitch group appears

Alphabets



Alphabet Button

- the Alphabet menu appears on the screen
- ❖ touch to select the alphabet of your choice

Buttonholes



Buttonhole Button

- the Buttonhole menu appears on the screen, including the eyelet and button sew-on programs

Quilting



Quilt Stitch Button

- the Quilt Stitch screen appears
- ❖ touch to select
- 15 quilt stitches are visible on screen
- use arrows to scroll for additional stitches

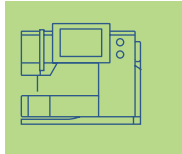

Personal Program



Personal Program Button

- Personal screen appears (customized settings)

Embroidery Mode / Sewing Mode

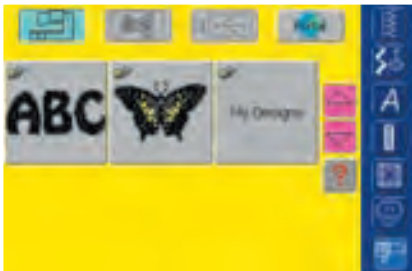

Embroidery Mode / Sewing Mode Button

- ❖ change between Embroidery and Sewing Mode and vice versa

Setup Program

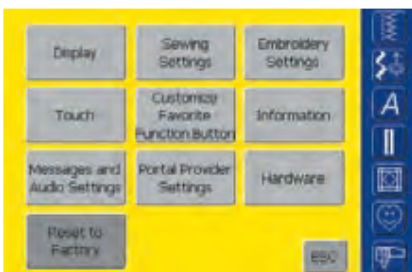

Setup Program

- options appear
- use Setup to customize your sewing computer's settings
- customized settings can be reprogrammed at any time or reset to BERNINA factory settings

External Function Buttons

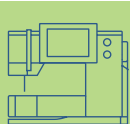

Altering Needle Position

- ❖ press the left or right Needle Position button
 - the needle moves to the right or left as selected
- ❖ keep button pressed to quickly change needle positions
- total of 11 needle positions: 5 left, 5 right, and 1 center

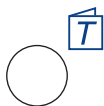

Tutorial

- ❖ press the Tutorial button
 - brief operating instructions, advice on fabric, needle or techniques, etc. appear

External Functions

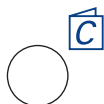

Creative Consultant

- ❖ press the Creative Consultant button
 - advice on fabric, needle or techniques, etc.

• for more information on Creative Consultant see pages 181-182



«clr» (Clear) Button

- ❖ press the «clr» button
 - stitch length, width and needle position are returned to basic settings
 - the active functions are reset

Exception:

Safety functions (e.g. Security Program, needle stop position, motor speed, alphabet size)



Favorite Function Button

- this button can be individually programmed in Setup with functions displayed
- the programmed function is shown with an «F» in the display
- selected function can be cancelled and reprogrammed at any time with another function

• for more information on the Favorite Function Button see page 170

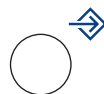

Setup Button

- ❖ press Setup
 - options with alteration possibilities appear
- ❖ touch one of the buttons
 - the desired alterations can be made
 - alterations remain even after the sewing computer is turned off («0»)
 - customized settings can be cancelled or reprogrammed at any time



Automatic Thread Cutter

- ❖ press external button
 - upper and bobbin thread are cut automatically

Important:
Raise the needle before activating the Automatic Thread Cutter function.



Quick Reverse Button on Head Frame

- ❖ press the Quick Reverse button on head frame
 - secure the seam beginning and end: sews in reverse as long as button is depressed
 - used to program buttonhole length
 - used to program darning length
 - used to designate end of stitching in straight stitch Securing stitch No. 5
 - securing with Quilter's Securing Program No. 324
 - used to start/stop stitching with the embroidery module (special accessory)



Pattern End (on head frame)

- ❖ press the Pattern End button
 - sewing computer stops at the end of the active single pattern or the active pattern of a combination

General functions

artista 730 features the following functions – accessible through different screens and programs.

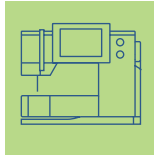

On-screen Functions



Single Mode

- the Single Mode is always active (blue) when turning on the sewing computer and only the selected stitch can be sewn



Combi Mode

- ❖ touch symbol
- the Combi Mode is active (blue) and stitch combinations can be programmed



Scroll Up

- ❖ touch symbol one or more times
- stitches within a stitch category scroll up to show more options
- touch the symbol continuously to scroll quickly



Scroll Down

- ❖ touch symbol one or more times
- stitches within a stitch category scroll down to show more options
- touch the symbol continuously to scroll quickly



«?» (Help)

- ❖ touch Help
- ❖ touch a stitch or a function
- a description of the selected stitch or function appears
- ❖ close with «ESC»

Note:

If you press the question mark the machine is «locked». If you touch the screen (anywhere) the machine will sew again.



Closing Special Applications

- ❖ touch «ESC»
- the special application closes
- returns to previous screen



OK

- ❖ touch symbol
- adjustment/selection is activated or confirmed, e.g. stitch selection by number
- programmed adjustment/selection is ready to sew

Special Functions

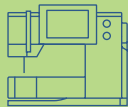

The following functions are found on the **artista 730** sewing computer. Each function which can be used in the selected program is either shown in the yellow part of the screen or on the two bottom rows of the gray part of the screen.



Presser Foot Indicator

- the recommended presser foot for the selected stitch is displayed by number
- ❖ touch symbol
- a screen will appear with further presser foot options
- if the presser foot is raised it is indicated with an arrow



Indication of the Altered Stitch Width or Stitch Length

- return to basic setting by touching the stitch width/stitch length bar



Long Stitch

- ❖ touch symbol
- sewing computer sews every second stitch (max. stitch length 10mm)
- can be activated for all practical, decorative, and directional stitches except buttonholes and sideways motion stitches
- functions and stitches can be combined
- can be programmed in Combi Mode and saved in File Drawers

Applications:

- combine with straight stitch to baste
- combine with triple straight stitch for topstitching



Pattern Extend 2–5 x

- ❖ touch one or more times
- the numbers 2–5 appear depending on the type of stitch selected
- the length of selected stitch will be increased by 2–5 times
- stitch integrity is maintained
- lengthened stitches can be programmed in Combi Mode
- ❖ touch the symbol longer and the function is turned off. The symbol is inactive (yellow)

Applications:

- lengthen existing stitches without affecting the stitch density
- combine stitches

Note:

The 0-9 function button (Stitch Selection by Number) as well as the History function button (the 15 last selected stitches) are always visible on the screen.



Pattern Begin

- the symbol is automatically highlighted in blue (= active), when a stitch is selected
- after beginning to sew the symbol is turned off (inactive, yellow)
- ❖ touch symbol
- the needle moves to the beginning of a stitch or stitch program

Applications:

- decorative stitches, buttonholes, working in Combi Mode



Horizontal Mirror Image (left/right)

- ❖ touch symbol
- sewing computer sews selected stitch in Horizontal Mirror Image (left/right – determined by the sewing direction)
- can be programmed in Combi Mode and saved in File Drawers

Applications:

- blindstitch for shell edging
- decorative stitching
- stitch combinations



Vertical Mirror Image (up/down)

- ❖ touch symbol
- sewing computer sews selected stitch in Vertical Mirror Image (up/down – determined by the sewing direction)
- can be programmed in Combi Mode and saved in File Drawers

Applications:

- decorative stitching
- stitch combinations

1,2,3...

Stitch Counter

- ❖ touch symbol
- ❖ when the desired length is reached (e.g. first buttonhole bead or straight stitch), press the external Quick Reverse button
- the display (or indicator) changes to «auto» (for the buttonhole, only after length of second bead is determined by pressing the Quick Reverse button)
- the selected stitch is programmed (temporarily)



Save

- ❖ touch symbol
- saves stitch combinations and letters



Delete

- ❖ touch symbol
- deletes individual stitches or letters above the cursor
- deletes stitch combinations
- deletes "Drawers" content



Combination Sub-divider (1)

- ❖ touch symbol
- each combination can be sub-divided into several parts
- each combination part is totally independent of one another



Combination Sub-divider (2)

- ❖ touch symbol
- each combination can be sub-divided as desired
- after stop press the foot control and the next part is sewn



Alphabet Size

- when an alphabet is selected the size is 9mm (field with 1 is blue)
- ❖ touch symbol
- size will be reduced to 6mm (field with 2 is blue)



Monogram Size

- when a monogram is selected the size is 30mm (field with 1 is blue)
- ❖ touch symbol once or twice
- the blue field shows the selected size:
 - 1 = 30mm (standard)
 - 2 = 20mm
 - 3 = 15mm



Multifunction Button

(only available in Combi Mode)

- ❖ touch symbol
- a special screen with further functions opens:
 - Delete Combination in SAA
 - Save Combination
 - Mirror Combination
 - Preview

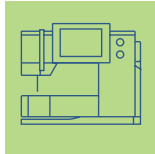

Direct Entry Length (in mm) or On-screen Button Measurement

- ❖ touch symbol
- buttonhole length (number in mm) can be entered directly by the stitch width knob
- ❖ for measuring the button, hold button to bottom lower left corner of screen and enter button length = adjust blue circle to button size using stitch width knob
- 2mm for the button thickness will be added automatically (with button measurement only)



Programming Buttonhole Length

- symbol is automatically highlighted in blue (= active) when a buttonhole is selected
- using the Quick Reverse button on head frame a buttonhole length can be determined directly
- when the buttonhole is programmed the symbol is turned off (inactive, yellow)
- if a new length is to be programmed the symbol has to be re-selected



Manual 4 or 6 Step Buttonholes

- ❖ touch symbol
- a special screen appears
- ❖ sew manual buttonhole in 4 or 6 steps (according to buttonhole type)



Needle Stop Adjustment

- ❖ touch the needle stop symbol
- arrow points down on screen (field is highlighted in blue)
- the sewing computer always stops with the needle down
- ❖ touch symbol again = needle stop reverts to up



Upper Case / Lower Case

- Upper Case is activated when Alphabet is selected
- ❖ touch symbol
- Lower Case is activated



Securing Function (with 4 stitches)

- ❖ touch symbol before starting to sew = individual stitches will be secured at the beginning
- ❖ touch symbol during sewing individual stitches = individual stitches will be secured at the end, the sewing computer continues sewing
- ❖ programming the function within a stitch combination = each individual stitch of the stitch combination can be secured at the beginning or at the end

Applications:

- sewing individual decorative stitches
- sewing individual letters
- sewing stitch combinations and words



Thread Tension

- ❖ touch symbol
 - the Thread Tension screen appears
 - the Thread Tension can be altered
 - the selected setting is visible in the field



Pattern Repeat 1–9 x

- by touching the symbol several times the numbers 1-9 appear
- 1 = sewing computer stops at the end of an individual stitch or stitch combination
- 2–9 = sewing computer stops at the end of a stitch or stitch combination after the number of repeats selected
- ❖ touch the symbol longer and the function is turned off. The symbol is inactive (gray)

Applications:

- sewing individual motifs
- combine with practical and decorative stitches
- in combination with 4-directional sewing



Balance

- ❖ touch symbol
 - Balance screen appears
- ❖ balance forwards and reverse stitches
- ❖ balance sideways motion stitches

Applications:

- adapting practical and decorative stitches to various types of fabrics (e.g. Honeycomb stitch)
- altering decorative stitches for a new look
- balancing buttonholes to different fabrics
- balancing sideways motion stitches to different fabrics



Motor Speed

1/4, 1/2, 3/4, 4/4

- ❖ touch symbol one or more times to select the desired speed
 - selected speed is displayed
 - reduces or increases the speed with the foot control fully depressed
- ❖ touch the symbol longer and the default speed (4/4) is set again

Applications:

- adjust speed for decorative sewing computer work such as freehand embroidery or freehand quilting and when more control is desired for the sewing task
- reduce speed when children are sewing



Security Program

- ❖ touch symbol
 - a special screen appears
 - by selecting the respective needle symbol the stitch width will be limited automatically
 - this prevents the inserted special needle (double needle, etc.) from hitting the presser foot or the stitch plate = avoiding needle breakage
 - the numbers represent the distance in mm between the needles of the double and triple needle
 - by selecting the respective stitch plate icon the stitch width is limited automatically so that the inserted standard needle cannot hit the stitch plate
 - once a feature is active the symbol turns red
 - selected functions remain active even after sewing computer is turned off («0»)/on
- ❖ touch «OK» to activate selected Security Program function
 - Security Program functions must be removed within Security Program by selecting desired needle and stitch plate

Applications:

- to stitch pintucks and for hemstitching
- hemming knits
- decorative stitches
- sewing special fabrics



Continuous Reverse Sewing

- ❖ touch symbol
- sews the selected stitch in reverse

Applications:

- darning with straight or running stitch
- decorative stitching on sleeves or trouser legs
- quilting



History

- ❖ touch symbol
- the last maximum 15 sewn stitches appear on a separate screen
- a stitch already contained in the History screen will be overwritten when sewing restarts
- same stitches with different settings have to be saved in the Personal Program
- ❖ select desired stitch = stitch appears in Stitch Altering Area
- sewn stitches remain in History even after sewing computer is turned off («0»)/on



myartista Portal

- ❖ connect the Modem or the Ethernet Card

- ❖ touch symbol

Modem:

- ❖ confirm first message with «Yes» and second message with «OK»
- the connection to the myartista Portal site is made

Ethernet Card:

- the sewing/embroidery computer tries to find an active Internet connection
- connection established, the myartista Portal site appears automatically



Stitch Selection by Number

- ❖ touch symbol
- special screen appears
- select individual stitch by touching the appropriate number combination
- ❖ touch «OK» to confirm selection and bring stitch into SAA

Applications:

- easy selection of individual stitch
- easy selection for stitch combination in Combi Mode



File Drawers

- ❖ touch symbol
- the Drawers screen appears



Lowered Feed Dog

- if the feed dog is lowered this symbol appears underneath the Presser Foot Indicator

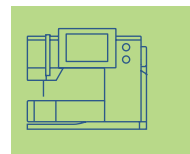

Thread Tension

Basic tension settings apply automatically when a stitch or program is selected.

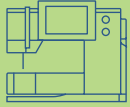

The tension is factory set for best possible sewing results using a 100 weight, 2 ply polyester thread (100/2).

The tension may vary when using other types of thread such as embroidery thread, and it may be necessary to adjust tension to suit the fabric and stitch type.



Thread Tension

- ❖ touch symbol



Altering the Tension

- the perfect stitch formation is shown on the left side of the screen (stitch formation in the fabric)
- the basic value is indicated by the bar on the scale (in blue)
- ❖ turn stitch width or stitch length knob to the left or right = the thread tension is loosened or tightened
- the tension alteration is indicated on the left side of the tension scale
- tighter upper thread tension (= the upper thread is tightened which pulls the lower thread more to the right side of the fabric)
- loosen upper thread tension (= the upper thread is loosened which pulls the upper thread more to the wrong side of the fabric)
- the tension alteration affects only the selected stitch and will be deleted with «clr» and does not remain saved when turning the sewing computer off («0»)
- the alteration is indicated on the scale and on the function button on screen
- the basic value stays visible (in black) when a change is made

Save and Close

- ❖ touch «OK»
- the alteration is saved, the screen display changes

Back to Basic Settings

- ❖ touch «Reset» to return tensions to the basic setting
- ❖ touch «OK» to confirm

No Adjustments

- ❖ touch «ESC»
- the existing thread tension is not changed

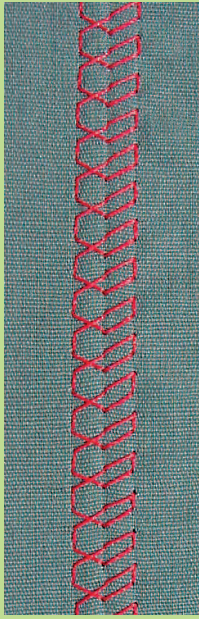

Summary Practical Stitches **36**

In General **38**

Temporary Altered Stitch
Memory **39**

Long Stitch Function **40**

Straight Stitches **41**

- Straight stitch No. 1 • Securing stitch No.5
- Edgestitching • Zippers • Triple straight stitch
 - Basting stitch

Zig-zag Stitch **50**

- Zig-zag No. 2 • Zig-zag seam • Triple Zig-zag

Blind Hem **52**

Sewing Knit Fabrics **53**

- Notes and tips for sewing knit fabrics
- Honeycomb stitch No. 8 • Vari-overlock No. 3
 - Double overlock No. 10
- Super stretch No. 11 • Stretch overlock No.13
 - Visible hem stitch with Jersey stitch No. 14
 - Ribbing with Vari-overlock No. 3
 - Hem with double needle • Ribbing

Reinforcing Edges **62**

Sewing on Elastic, Shirring
Elastic/Cord **63**

Darning, Repairing **67**

- Automatic darning • Manual darning
 - Patching knits and jersey

Freehand Embroidery **70**

Bartack Programs **71**

- Bartack • Fly stitch

Practical Stitches

Summary Stitches

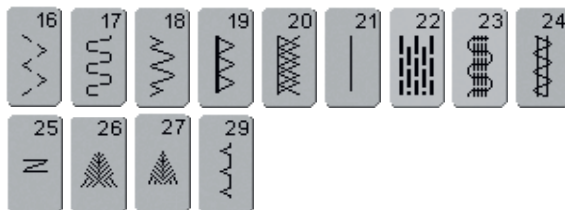

Summary

Application of Practical Stitches



1 Straight stitch
All non-stretch fabrics. All straight stitch work



2 Zig-zag
Most fabric types. All simple zig-zag applications such as oversewing fine fabrics, attaching elastic, lace and appliqué



3 Vari-overlock
Primarily for fine jerseys, stretch overlock seams, hems and stretch seams



4 Running stitch
Most types of fabric. Mending, patching, reinforcing seams



5 Securing stitch (straight stitch)
All types of fabric. Secures the beginning and end of seams sewn with straight stitch



6 Triple straight stitch
Reinforced seams in firm, heavy fabrics, topstitching and visible seams



7 Triple zig-zag
Reinforced seams in firm fabrics, visible hems and seams, decorative stitching, couching



8 Honeycomb stitch
Most types of interlock and smooth fabrics, visible seams, hems, linens and some types of mending

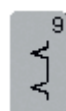

9 Blindstitch
Most types of fabric. Blind hems, shell edging on soft jerseys and fine fabrics, decorative seams



10 Double overlock
All types of knit. Sews and finishes the edges in one operation

**11 Super stretch**

Open seam in all super-stretch fabrics, such as Lycra

**12 Gathering stitch**

Most types of fabric. Gathering with shirring elastic. Butted seams (edge to edge) and decorative stitching

**13 Stretch overlock**

Mediumweight knits, toweling and firm wovens. Overlock seams, flat joining seams

**14 Jersey stitch**

Natural, blended or synthetic fabrics and delicate knits. Visible seams and hems. Mending jersey/interlock

**15 Universal stitch**

Firm fabrics such as felt and leather. Flat joining seams, visible seams, attaching elastic, decorative seams

**16 Sewn-out zig-zag**

Oversewing woven fabrics, reinforcing edges, attaching elastic, decorative seaming

**17 Lycra stitch**

All two-way stretch fabrics, flat joining seams and hems, reinforced seaming on underwear

**18 Stretch stitch**

All stretch fabrics, open seam in sportswear

**19 Reinforced overlock**

Medium-to heavyweight knits and toweling, overlock seams, flat joining seams

**20 Knit overlock**

All knits, machine or handmade, overlock seam. Sews and finishes edges in one operation

**21 Basting**

Basting seams, hems, etc.

**22 Simple darning program**

Automatic darning in fine and mediumweight fabrics

**23 Reinforced darning program**

Automatic darning in heavyweight fabrics

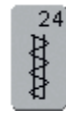
**24 Bartack program**

Reinforcing pocket edges, belt loops, etc.

**25 Bartack program**

Reinforcing pocket edges, belt loops, securing zippers

**26 Fly stitch large**

Medium- to heavyweight fabrics, reinforcing pocket edges, zippers and openings

**27 Fly stitch small**

Fine to mediumweight fabrics, reinforcing pocket edges, zippers and openings

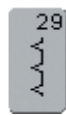
**29 Blindstitch narrow**

Blind hems on fine fabrics

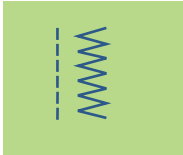

In General

Adjusting Individual Practical Stitches

Depending on the fabric and application an alteration of the basic settings may be necessary.

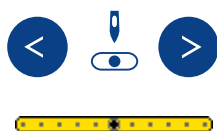
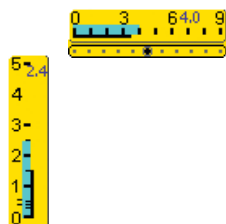
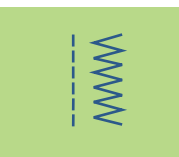

Altering Stitch Width and Stitch Length

- ❖ depending on the fabric it may be necessary that the stitch width or the stitch length is altered
- ❖ can be altered while sewing
- ❖ use stitch width or stitch length knob to make alteration

Changing the Needle Position

- ❖ press Needle Position buttons to change the needle position, so stitching can be placed exactly where it is required
- there are a total of 11 needle positions (5 left, 5 right, and 1 center)
- ❖ keep button pressed to change needle positions quickly

Securing With Quick Reverse Button (on Head Frame)

- secures the seam beginning and end
- ❖ press the Quick Reverse button and the sewing computer sews in reverse
- ❖ release the Quick Reverse button and the sewing computer sews forward

Practical Stitch Seams



Open Seams

Seams with seam allowances pressed open

- seam allowances of up to approx. 1.5cm
 - seam lies flat
 - seam does not stretch
- Suggested stitches:
- straight, narrow zig-zag, super stretch, and triple zig-zag

Application:

- for woven fabrics
- works for most types of sewing projects, including clothing, home accessories, and crafts

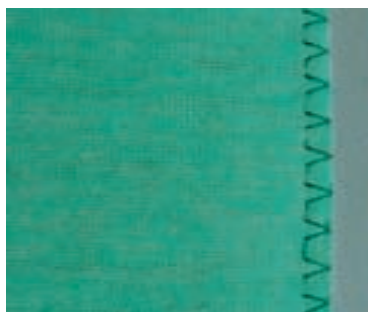

Overlock Seams

Seams which cannot be pressed open

- sewn and finished in one operation
 - narrow seam allowances
- Suggested stitches:
- vari-overlock, double overlock and jersey

Application:

- for knits and jerseys
- excellent for knit clothing, lingerie, and bed linens, Jersey

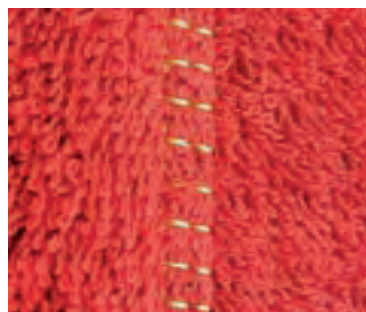

Flat Joining Seams

Seams where the edges are overlapped and then sewn

- stitching is on the seam allowances

Suggested stitch:

- stretch-overlock

Application:

- particularly good for toweling and Lycra
- also good for beachwear, leisure wear, and lingerie

Temporary Altered Stitch Memory

Stitch: **any selected stitch**

Temporary Altered Stitch Memory

- stitch length, stitch width, needle position, etc. are automatically saved
- by altering the stitch width and stitch length, all stitches can suit both the fabric and sewing
- the Temporary Altered Stitch Memory is particularly useful when alternating between two applications, such as overcasting edges, zig-zag, vari-overlock, within the same project
 - the stitches can be changed as needed
 - when changing back to the altered stitch, the previous individually altered setting will stay saved

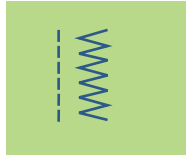

Note:

The altered stitch memory can hold as many stitch alterations as needed (these are stitch length, stitch width, Needle Position, Mirror Images, Pattern Extend, Long Stitch function, Thread Tension, Balance and Pattern Repeat function 1-9x).

Example:

- ❖ select Zig-zag stitch No. 2 and alter stitch width to 9mm (e.g. overcasting an edge)
- ❖ select straight stitch and sew seam
- ❖ overcasting another edge: select the Zig-zag stitch No. 2 again
 - the altered setting of the stitch width to 9mm stays saved

Return to Basic Settings – Delete Altered Stitch Memory

- Method 1: press the external «clr» button (active stitch in basic setting)
- Method 2: revert to the stitch width and length by touching the stitch width/stitch length bar (or manually by turning the external knob) revert to other functions manually
- Method 3: turn sewing computer off («0») – altered settings will not be saved

TIP

Save the altered basic settings

Save the stitch with altered basic settings in the Personal Program or to save the settings permanently.

- for more information on «Personal Program» see pages 153-156

- for more information to save the settings permanently see page 24

Long Stitch Function

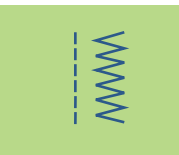

Long Stitch Function

- the sewing computer sews every second stitch (the longest stitch possible is 10mm when the stitch length is set at 5mm)
- works with the practical and decorative stitches
- for all work where a longer stitch is required
- additional alteration of stitches possible

Sewing With the Long Stitch Function

- ❖ select desired practical or decorative stitch
- ❖ select Long Stitch function. Altered stitch is then visible in the Stitch Altering Area

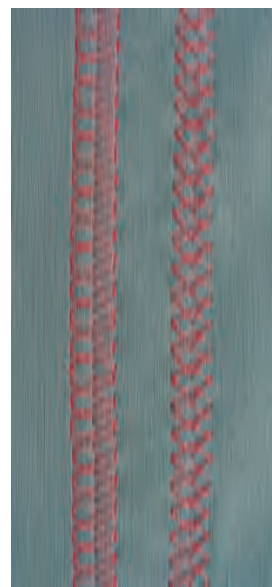

TIP

Decorative topstitching with cordonnet thread

- for decorative topstitching the Long Stitch function can be combined with the triple straight stitch
- when sewing with a cordonnet thread use needle No. 100-110 or cordonnet needle No. 90-100

TIP

Long stitch for basting

The Long Stitch function in combination with the straight stitch can be used for basting.

Straight Stitch

Stitch: **Straight stitch No. 1**
Needle: **size and type suitable for the fabric selected**
Thread: **cotton or polyester**
Feed dog: **up (sewing position)**
Presser foot: **Reverse pattern foot No. 1C**

Straight Stitch

- after turning the sewing computer on, the Practical Stitch screen with the activated straight stitch appears

Applications

Application

- suitable presser foot to be selected according to the technique
- suitable for all fabrics

TIP

Adjust the stitch length to suit the fabric

For example use a longer stitch length (approximately 3 - 4mm) with denim, a shorter length (2 - 2.5mm) with batiste.

TIP

Adjust the stitch length to suit the thread

For example use a longer stitch length (approximately 3 - 5mm) when sewing with cordonnet thread for topstitching.

TIP

Activate needle stop down

Prevents the fabric from slipping when you stop to adjust stitch.



Securing Stitch

Stitch: **Securing stitch No. 5 (straight stitch)**
Needle: **size and type suitable for the fabric selected**
Thread: **cotton or polyester**
Feed dog: **up (sewing position)**
Presser foot: **Reverse pattern foot No. 1C**

Securing Stitch

- for all fabrics
- secures beginning and the end of seam
- reverse stitching is exactly on top of the seam, preventing puckers

Beginning the Seam

- the sewing computer secures the seam automatically (5 stitches forward, 5 stitches reverse)
- the sewing computer continues straight stitching forwards

Ending the Seam

- ❖ when coming to the end of the seam, press and release the Quick Reverse button on head frame. The sewing computer will then secure the seam automatically (5 stitches forward, 5 stitches reverse)
- sewing computer stops automatically when securing is completed

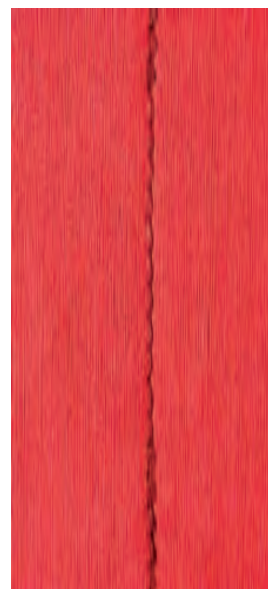

TIP

Seaming or sewing long seams

Quicker securing at beginning and end of seam.

Edgestitching

- Stitch: **Straight stitch No. 1**
- Needle: **size and type suitable for the fabric selected**
- Thread: **cotton, polyester, cordonnet (topstitching)**
- Feed dog: **up (sewing position)**
- Presser foot: **Reverse pattern foot No. 1C, Blindstitch foot No. 5 or Edgestitch foot No. 10 (optional accessory)**



Narrow Edgestitching

Needle Position

- left for outer edge
- right for inner edge (hem edges)

Presser Foot

- Blindstitch foot No. 5

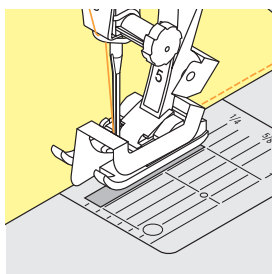

Outer Edges

- ❖ place finished or folded edge of fabric against the left side of the guide on the foot
- ❖ select needle position left at desired distance from the edge

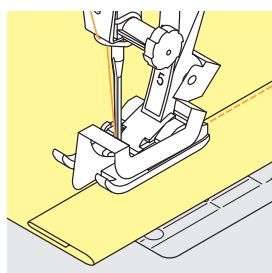

Hem Edges

- ❖ place edge of fold (inside upper edge of hem) against the right side of the guide on the foot
- ❖ set to right needle position to stitch along upper edge

Note:

- Foot No. 5: use any left or far right needle position.**
- Foot No. 10: use any left or right needle position.**



Wide Edgestitching

Needle Position

- any needle position can be used according to the width of the stitching
- different needle positions will place the stitching at various distances from the edge of the fabric

Presser Foot

- Reverse pattern foot No. 1C

Guiding the Fabric

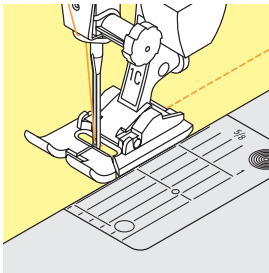

Presser foot as a guide:

- ❖ align the edge of the presser foot with the finished or folded edge of the fabric

Stitch plate as a guide:

- ❖ guide the folded edge along the marks on the stitch plate for stitching 3/8" to 1 1/8" (1cm–2.5cm) from the edge

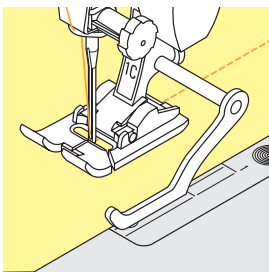

Seam guide as a guide:

- ❖ insert the seam guide into the hole on the back of the presser foot shank
- ❖ adjust as desired, measuring from the needle
- ❖ tighten the screw
- ❖ guide the finished or folded edge of the fabric along the seam guide
- ❖ to sew parallel wider lines, guide the seam guide along a previously sewn line of stitches

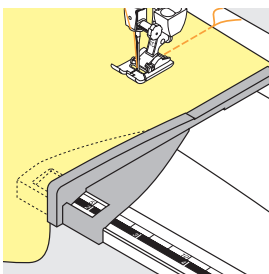

Seam guide for slide-on table:

- ❖ insert into the groove (underside of table)
- ❖ position right of the presser foot in the desired distance
- ❖ guide fabric along the seam guide

TIP

Edgestitching with seam guide

Eliminates tedious marking when sewing parallel lines or grids.

TIP

Zipper foot No. 14 (optional accessory) can be used for edgestitching when the guide on the foot is adjusted as desired.

Zippers

- Stitch: **Straight stitch No. 1**
Needle: **size and type suitable for the type of fabric selected**
Thread: **cotton or polyester**
Feed dog: **up (sewing position)**
Presser foot: **Zipper foot No. 4 or Zipper foot with guide No. 14 (optional accessory)**
Needle position: **far right or far left**

Preparation

- ❖ baste seam closed and finish the seam allowance
- ❖ baste or pin zipper in place so that fabric edges meet over the center of the zipper

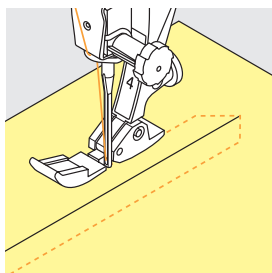

Sewing

- ❖ open zipper a little
- ❖ start sewing from top left
- ❖ position the foot so the needle stitches along the edge of the zipper coils
- ❖ stop in front of the pull (needle position down), raise the presser foot and close zipper again
- ❖ continue to sew to the base of the zipper (needle position down)
- ❖ turn sewing and sew across the seam (needle position down)
- ❖ turn sewing again and sew second side of the zipper from bottom to top

Variation: Sew Both Sides of Zipper from Bottom to Top

- suitable for all fabrics with nap or grain (e.g. velvet)
- ❖ prepare zipper as described above
- ❖ start sewing in the seam of the zipper end and sew first side from bottom to top
- ❖ sew the second side the same way from bottom to top



TIPS

Zipper as a decorative element

Sew a visible zipper into the fabric as a decorative element.

To sew around the zipper pull

- ❖ close the zipper and sew up to about 2" (5cm) away from the pull
- ❖ stop with the needle down in the fabric, raise the presser foot. Open zipper, pulling the tab below the needle; lower presser foot and continue to sew

TIPS

Starting to sew

Hold threads firmly when starting to sew and pull the fabric gently behind the needle for a few stitches.

Zipper tape or firm fabric

For even stitch formation use a 90 – 100 needle.

Invisible Zipper



- Stitch: **Straight stitch No. 1**
Needle: **middle**
Thread: **cotton or polyester**
Feed dog: **up (sewing position)**
Presser foot: **Invisible zipper foot No. 35 (optional accessory) and Open embroidery foot No. 20C**
Zipper length: **opening plus 1 1/2" (4cm) allowance**



Invisible Zipper

- special zippers are used. When inserted they are covered by the seam, making them invisible
- is particularly elegant when used on clothing

Sewing First Half of the Zipper

- ❖ mark the seam beginning (zipper end)
- ❖ open zipper fully
- ❖ place right side of zipper on right side of fabric (the coils point away from the fabric edge)
- ❖ pin one half of the zipper and baste
- ❖ lower presser foot at the beginning of the zipper so that the zipper coils are positioned in the groove (it may be helpful to tilt the zipper coils slightly by hand)
- ❖ sew first half of the zipper from top to bottom up to the mark





Sewing Second Half of the Zipper

- ❖ close zipper and pin the second half on top of the inside
- ❖ open zipper again, pin the entire length and baste
- ❖ sew from top to bottom – the zipper coils are now positioned in the other groove
- ❖ close zipper

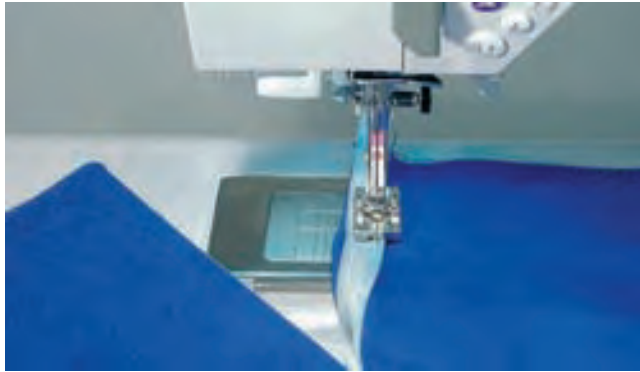
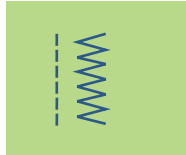

Closing Seam

- ❖ attach Open embroidery foot No. 20C (improves overview)
- ❖ pin and baste seam
- ❖ sew seam from top to inserted zipper, staying as close as possible to the zipper
- ❖ if a small opening results, use Zipper foot No. 4 to close it (altered needle position)



TIP

Shorten zipper

Trim a zipper that is too long and secure end with Bartack program No. 25.

Triple Straight Stitch Seam



Stitch: **Triple straight stitch No. 6**
Needle: **Jeans or 80-90 universal**
Thread: **cotton or polyester**
Feed dog: **up (sewing position)**
Presser foot: **Reverse pattern foot No. 1C or**
Jeans foot No. 8

Open Seam

- durable seam for firm and densely woven fabrics such as denim and corduroy
- reinforced seam for garment areas subject to hard wear



TIP

For heavy layers or very densely woven fabrics:

A Jeans needle or Jeans foot No. 8 will help when sewing very heavy fabrics, such as denim or canvas.

TIP

Decorative top stitch

Lengthen out stitch and use as a decorative top stitch with denim.

Basting Stitch

Stitch:	Basting stitch No. 21
Needle:	size and type suitable for the fabric selected
Thread:	cotton or polyester
Stitch length:	3.5 - 5mm
Feed dog:	up (sewing position)
Presser foot:	Reverse pattern foot No. 1C

Basting Stitch

- straight stitch, sewing every fourth stitch (i.e. longest stitch possible is 20mm when the stitch length is set at 5mm)
- for all work where a very long stitch is required
- quick and easy basting of seams, hems, quilts, etc.
- easy to remove

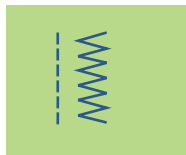

TIP

Securing a basting seam at the beginning and end

To secure basting stitches at the seam beginning and end, sew a few normal length straight stitches or select the Securing function.

TIP

Basting

Use a fine darning thread; it is easier to remove after the seam has been sewn.

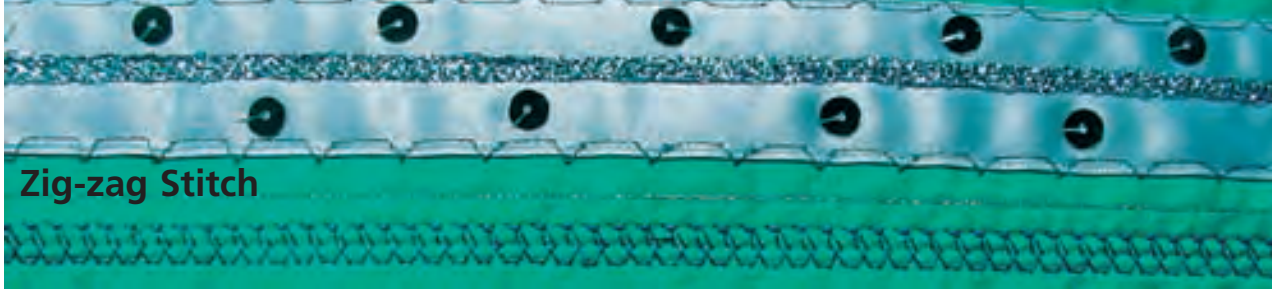

Zig-zag Stitch



Stitch: **Zig-zag stitch No. 2**
 Needle: **size and type suitable for the fabric selected**
 Thread: **cotton or polyester**
 Feed dog: **up (sewing position)**
 Presser foot: **Reverse pattern foot No. 1C**

Zig-zag Stitch

- suitable for all fabrics
- overcasting
- elastic seams
- decorative sewing

Oversewing Edges

- ❖ guide edge of fabric into the center of the presser foot
- ❖ do not select too wide a width or too long a stitch – the edge should lie flat and not roll
- needle goes into fabric on one side and over the edge into the air on the other side
- ❖ use a fine darning thread for lightweight fabric



A B C

A
Zig-zag stitch with altered stitch length

B
Zig-zag stitch with altered stitch width

C
Finishing the edges with zig-zag stitch

Satin Stitch



- filled-in stitch used for appliqué, embroidery, etc.
- shorten stitch length, satin stitch setting will be indicated by parallel lines on stitch length bar

Note:

The sewing computer has a programmed satin stitch: No. 354 (see page 143).

TIP

Oversewing edges

If edges roll, use the Vari-overlock stitch and foot No. 2A.

TIP

Embroidery with satin stitch

Experiment with adjusting the stitch width for new decorative effects.

Visible Hem With Triple Zig-zag Stitch



Stitch: **Triple Zig-zag stitch No. 7**
Stitch width: **2.5 – 9mm depending on fabric**
Stitch length: **basic setting**
Needle: **universal or Jeans**
Thread: **cotton or polyester**
Feed dog: **up (sewing position)**
Presser foot: **Reverse pattern foot No. 1C**

Strong Visible Seam

- for firm, densely woven fabrics, particularly good for denim and canvas

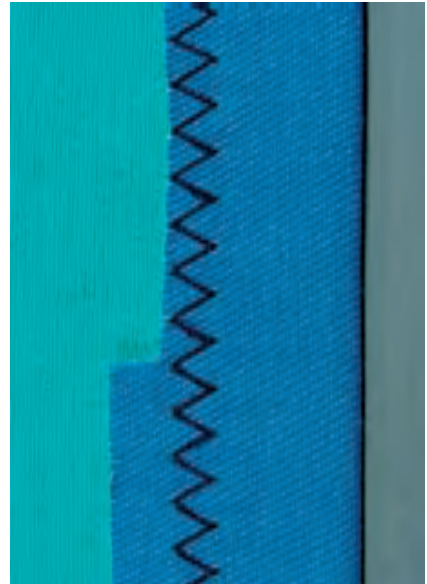

TIP

Hems on fabrics which may ravel

Finish the raw edge of the hem; do not trim them after sewing.

TIP

Sewing firm fabrics

Use a Jeans needle for better penetration.

Blind Hem



Stitch: **Blindstitch wide No. 9,
Blindstitch narrow No. 29**
Needle: **size and type suitable for the fabric selected**
Thread: **cotton, polyester, silk or monofilament**
Feed dog: **up (sewing position)**
Presser foot: **Blindstitch foot No. 5**

Blind Hem Wide No. 9

- for invisible hems in medium to heavy fabrics

Blind Hem Narrow No. 29

- for invisible hems in batiste

Preparation

- ❖ finish the raw edges as desired
- ❖ fold the hem and baste or pin in place
- ❖ fold the garment back over the right side of the fabric to expose the finished lower edge (see drawing below)
- ❖ place the work under the presser foot with the guide positioned against the folded back fabric

Sewing

- the needle should just pierce the edge of the fold
- ❖ after sewing about 4" (10cm), check both sides of fabric and adjust the stitch width if necessary

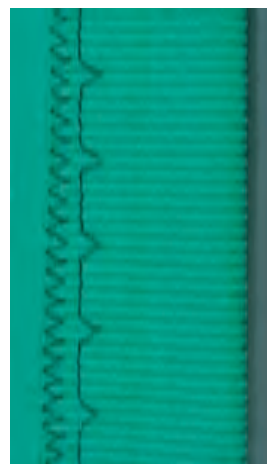

Blind hem wide



Blind hem narrow

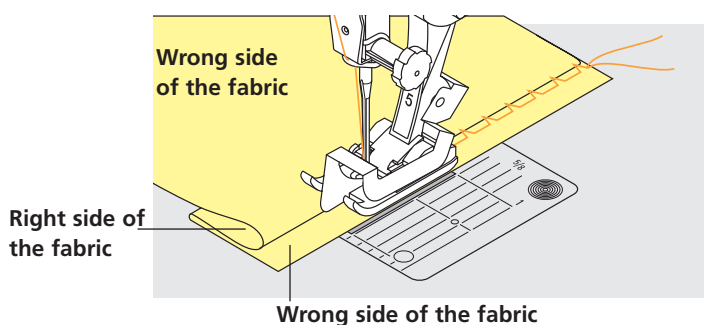

Note:

Small stitches are visible on the right side (decorative effect).

TIP

Fine stitch width adjustment

- ❖ sew a test on the fabric. Adjust the stitch width to suit the fabric so that the needle just pierces the edge of the fold
- ❖ guide the raw edge along the guide on the foot to keep the stitch depth even

Sewing Knit Fabrics

Important Notes:

Start With a New Needle

- blunt needles can damage knits

Use a Stretch Needle (130/705 H-S) if Necessary

- the needle point slides easily between the fibers

Use a Fine Sewing Thread

- coarse threads can damage knits and cause holes when the garment is washed

When Basting, Use a Darning Thread

- very lightweight (80 weight) darning thread is easier to remove once the seam is complete

Sew a Test if Necessary

- the elasticity of today's knit fabrics varies greatly
- ❖ adjust basic settings to suit the fabric, the seam should be as elastic as the fabric
- ❖ for greater elasticity use a shorter stitch length and/or stitch width (only one of these adjustments may be necessary)

Presser Foot Pressure

- soft, loose knits can wave when sewn:
- ❖ reduce the pressure until the seam lies flat
- the sewing computer must still feed the fabric properly



Possible Problems With Sewing Knits

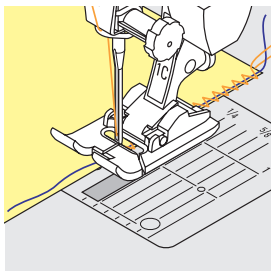

Seam Becomes Wavy

- ❖ oversew a thread along the edge
- ❖ after sewing adjust edges by pulling the thread to regain the original length of the fabric and press seam flat

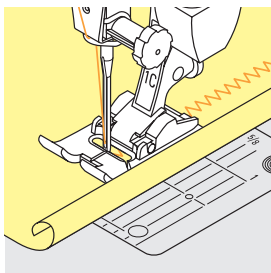

Edges Roll

- ❖ do not sew right on the edge but about 5mm in from the edge
- ❖ cut off allowance after finished sewing

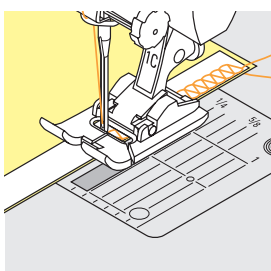

Seams Which Pull or Stretch

- ❖ reinforce seams with a ribbon (e.g. shoulder ribbon) before sewing
- ❖ different ribbons are available which can stretch more or less. These can be sewn to give more security to the seam

Honeycomb Stitch Edges



Stitch: **Honeycomb stitch No. 8**
Needle: **universal, ballpoint, or stretch cotton or polyester up (sewing position)**
Thread: **up (sewing position)**
Feed dog: **Reverse pattern foot No. 1C**
Presser foot:

Honeycomb Stitch Edges

- for all cotton, wool, synthetic and mixed fiber knits

Preparation

- ❖ turn the raw edge under by 3/8" (1cm); press and baste if required

Sewing

- ❖ sew from the right side a presser foot away from the edge
- ❖ trim excess fabric from the wrong side

Balance/Corrections

The Honeycomb stitch opens up and it does not look correct:

- ❖ turn the stitch length knob until the stitch in the right portion of the screen is identical with the stitch on the fabric

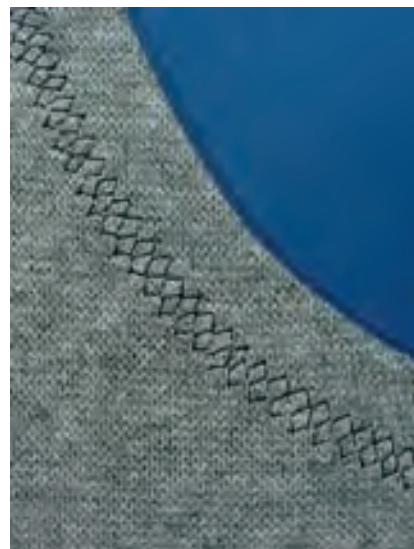

- for more information on the Balance function see page 183

TIP

Needle stop down

Needle stays in fabric when pivoting around curves (neck edges and armholes).

Overlock Seams

Vari-overlock Seam



Stitch: **Vari-overlock No. 3**
Needle: **size and type suitable for the fabric selected**
Thread: **cotton or polyester**
Feed dog: **up (sewing position)**
Presser foot: **Overlock foot No. 2A**

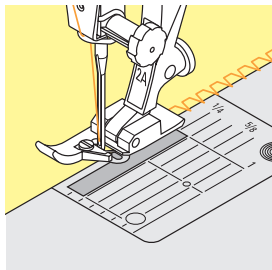

Closed Seam

- elastic seam in fine, soft knits such as silk jersey and interlock

Sewing

- ❖ guide the raw edge along the pin on the overlock foot
- ❖ the stitch will form over the pin and over the edge of the fabric

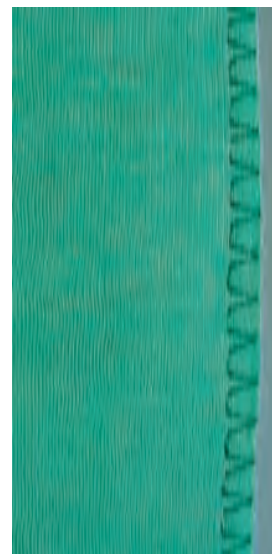

Double Overlock Seam/Jersey Overlock Seam



Stitch: **Double Overlock No. 10**
or Jersey Overlock No. 20
Needle: **size and type suitable for the fabric selected**
Thread: **cotton or polyester**
Feed dog: **up (sewing position)**
Presser foot: **Overlock foot No. 2A**

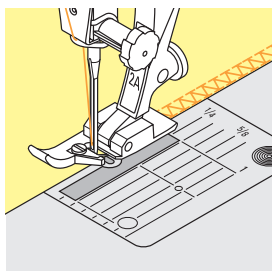

Closed Seam

- overlock seam in loose knits and cross seams in knits and jerseys

Sewing

- ❖ guide the raw edge along the pin on the overlock foot
- ❖ the stitch will form over the pin and over the edge of the fabrics



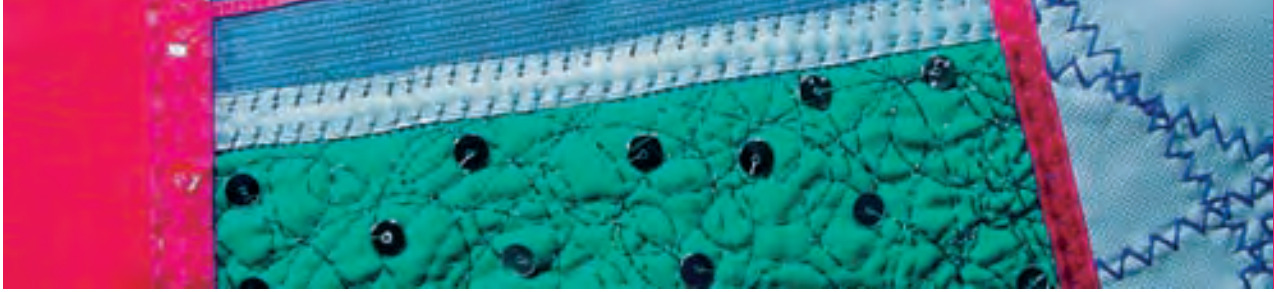

Stretch Overlock Seam/Reinforced Overlock Seam



Stitch: **Stretch overlock No. 13
or Reinforced overlock No. 19**
 Needle: **universal, ballpoint or stretch
cotton or polyester**
 Thread: **cotton or polyester**
 Feed dog: **up (sewing position)**
 Presser foot: **Reverse pattern foot No. 1C or
Overlock foot No. 2A**

Closed Seam

- overlock seam in coarse or loose knits

Sewing

- ❖ sew stretch overlock along the fabric edge
- ❖ the stitch should sew over the edge of the fabric on the right swing of the needle

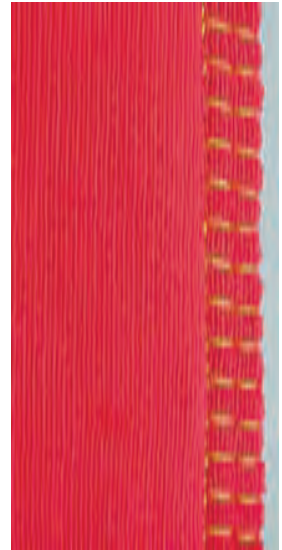

Super Stretch/Stretch Seam



Stitch: **Super stretch No. 11 or Stretch No. 18**
 Needle: **universal, ballpoint or stretch
cotton or polyester**
 Thread: **cotton or polyester**
 Feed dog: **up (sewing position)**
 Presser foot: **Reverse pattern foot No. 1C**

Open Seam

- very elastic seam for knit fabrics
- ideal for sports and leisure wear
- seam lies flat and is not bulky



TIP

Do not stitch right on the edge with difficult material (e.g. when edges tend to roll in). Instead sew approx. 1 cm (1/2") from the edge.



Flat Joining Seam



Stitch: **Stretch overlock No. 13**
 Needle: **universal, ballpoint or stretch**
 Thread: **cotton or polyester**
 Feed dog: **up (sewing position)**
 Presser foot: **Reverse pattern foot No. 1C**



Flat Joining Seam

- ❖ fabric edges are overlapped and the stitch is placed on the seam allowance which produces a very flat, durable seam
- ideal for fluffy, thick materials such as terry cloth, felt and leather

Sewing

- ❖ sew stretch overlock along the fabric edge
- the stitch should sew over the edge of the top layer of fabric on the right swing of the needle

TIP

Fabric and thread

When using a matching thread color, this seam is hardly visible in fluffy fabrics.

TIP

Thick seam

Particularly suitable for fabrics in which a normal straight stitch seam would stretch open.

Hems With Practical Stitches

Visible Hem With Jersey Stitch



Stitch: **Jersey stitch No. 14**
Needle: **universal, ballpoint or stretch**
Thread: **cotton or polyester**
Feed dog: **up (sewing position)**
Presser foot: **Reverse pattern foot No. 1C**

Visible Stretch Hem

- for all types of cotton, wool, synthetic and mixed fiber jerseys

Preparation

- ❖ fold and press hem; baste if required

Sewing

- ❖ sew hem at desired depth (right side)
- ❖ trim excess fabric (wrong side)



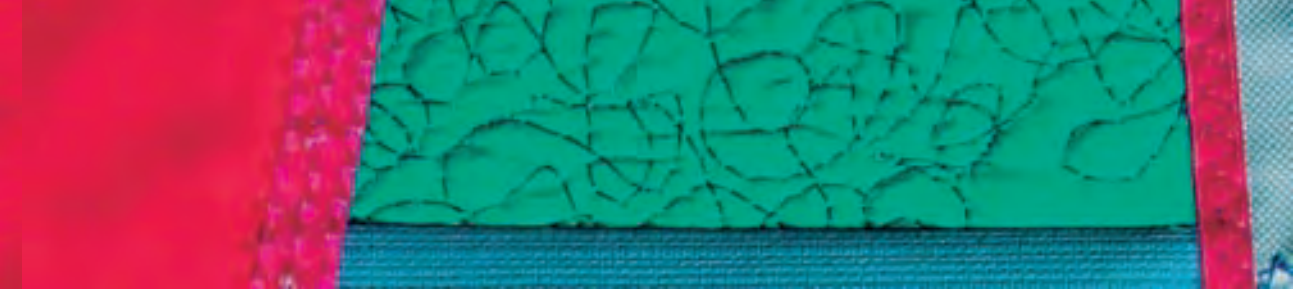

Ribbing With Overlock Seams



Stitch: **Vari-overlock No. 3**
 Needle: **size and type suitable for the fabric selected**
 Thread: **cotton or polyester**
 Feed dog: **up (sewing position)**
 Presser foot: **Overlock foot No. 2A**

Ribbing With Overlock Seam

- for all fine cotton, synthetic and mixed fiber knits

Preparation

- ❖ cut ribbing twice the finished width plus double the seam allowance
- ❖ fold ribbing in half
- ❖ pin and baste to opening, front edge to outside

Sewing

- ❖ sew vari-overlock over the raw edge
- ❖ guide the raw edge along the pin of the foot
- ❖ the stitch will form over the pin and over the edge of the fabric



Right side



Wrong side

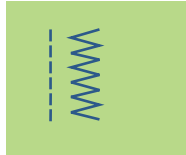

TIP

Preventing the ribbing from becoming wavy

Cut ribbing slightly shorter than the opening and pull slightly when pinning.

TIP

Needle stop down

Needle stays in fabric when pivoting around curves (neck edges and armholes).

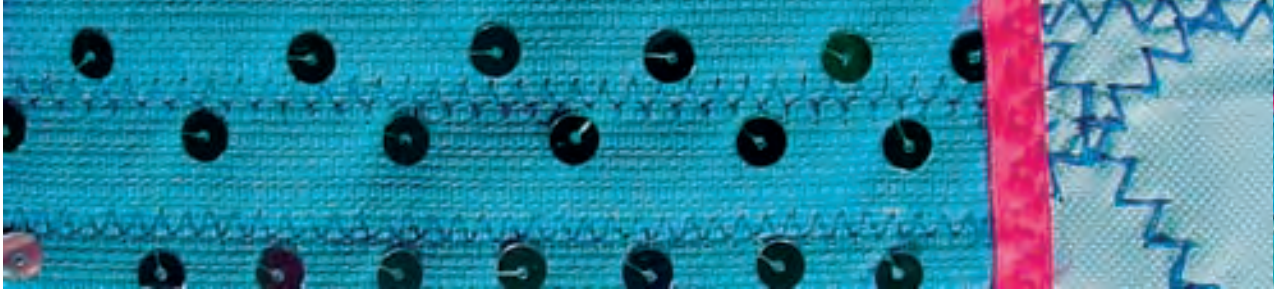

Hems With Double Needle

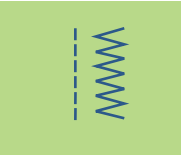

Stitch: **Straight stitch No. 1**
 Needle: **double needle**
 Thread: **cotton or polyester**
 Feed dog: **up (sewing position)**
 Presser foot: **Reverse pattern foot No. 1C**

Hem Finish in Knits

- elastic hems in knits
- no additional overcasting necessary

Preparation

- ❖ turn the raw edge under the width desired; press and baste, if required
- ❖ insert double needle into the sewing computer and thread; threading see page 16
- ❖ recall Security Program, select suitable double needle and stitch plate (appropriate double needle limitation – e.g. for a double needle of 4mm select double needle button 4.0)

Sewing

- ❖ sew on the right side along the seam edge (on the right side two parallel stitch lines are visible, on the wrong side a zig-zag stitch is visible)
- ❖ trim excessive fabric back to about 2mm from the stitches



TIP

Exact sewing

Use guide line on stitch plate or seam guide.

TIP

Adjusting stitch length

Increase stitch length according to fabric.

TIP

More elastic seam

Use wooly nylon as bobbin thread which results in a more elastic seam.



Ribbing Finish

Ribbing

- decorative and very practical way of finishing the edges
- suitable for sweatshirts, pajamas – either way, etc.



Cutting

- ❖ width: twice the finished width plus double the seam allowance
- ❖ length: desired length plus double the seam allowance
- ❖ check length by putting the ribbing folded in half around neck, waist, wrist, or ankle (check whether ribbing around the neck is wide enough to be pulled over the head)



Preparation / Sewing

- ❖ make a circle out of the ribbing and sew according to seam allowance (choose suitable overlock stitch according to fabric)
- ❖ fold the ribbing in half, the seam to inside (baste edges)
- ❖ divide ribbing in four equal sections and mark quarters (mark No. 1 is the seam)
- ❖ divide edge of the garment also in four equal sections and mark quarters
- ❖ pin right side of ribbing to right side of garment, the four marks matching. The ribbing seam should be placed to the back or on shoulder seam
- ❖ sew with a machine overlock stitch (according to fabric)

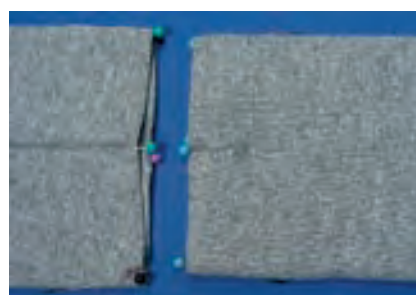

TIP

Using ready-made ribbing

The job is made easier as there is no cutting.

Reinforced Edges on Woven Fabrics

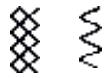

Stitch: **Honeycomb stitch No. 8
or Running stitch No. 4**
Needle: **size and type suitable for the fabric selected**
Thread: **lightweight darning thread**
Feed dog: **up (sewing position)**
Presser foot: **Reverse pattern foot No. 1C**

Reinforced Edges

- good for work clothes, table linen, towels, etc.
- use a cord to match the color of the fabric.
This gives additional strength

Suitable Cords

- Perle cotton
- fine crochet yarn
- strong hand-sewing thread
- gimp (not from home dec department)

Sewing

- ❖ oversew edges with Honeycomb or Running stitch by oversewing a cord along the edge for added reinforcement
- ❖ if necessary sew a second row further in from the edge

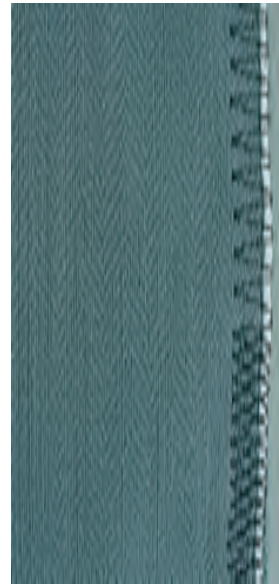

Sewing on Elastic, Shirring Elastic/Cord

Gathering



Stitch: **Gathering stitch No. 12**
Needle: **size and type to suit the fabric selected**
Thread: **cotton or polyester**
Feed dog: **up (sewing position)**
Presser foot: **Buttonhole foot No. 3C**

Shirring Elastic/Cord

- for gathering lengths of fabric, for finishing children's and doll clothing, crafts, etc.

Preparation

- ❖ cut shirring elastic or cord double the length of the edge and fold in half lengthways
- ❖ hook over the center toe on the buttonhole foot
- ❖ take both ends of the cord under the foot to the back
- ❖ shirring elastic/cord lies in the openings of the buttonhole foot

Sewing

- ❖ sew a few stitches
- ❖ lift the elastic or cord at the front and pull towards you, leave ends behind the presser foot
- ❖ oversee cord without stitching into it
- ❖ stretch elastic while sewing; the more it is stretched, the tighter the gathers
- ❖ after sewing, pull the cord to gather the fabric

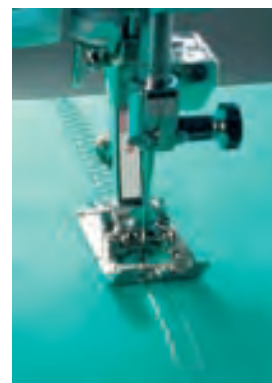
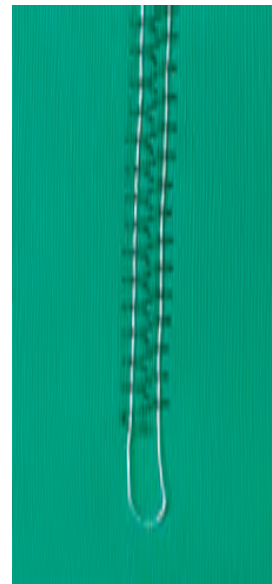

TIP

Securing beginning and end

Sew a few stitches with the feed dog lowered.

TIP

Presser foot pressure

Increase the foot pressure for better feeding of the fabric and cord if necessary.

TIP

Gathering of long lengths of fabric

Use two separate gathering cords instead of one hooked over the center toe.

Sewing on Elastic, Shirring Elastic/Cord

Sewing on Narrow Elastic With Universal Stitch



Stitch: **Universal stitch No. 15**
Stitch width: **depends on width of elastic**
Needle: **type and size to suit the fabric selected**
Thread: **cotton or polyester**
Feed dog: **up (sewing position)**
Presser foot: **Reverse pattern foot No. 1C or Embroidery foot No. 6 (optional accessory)**

Sewing on Elastic

- for gathering long lengths of fabric
- for ruffles and flounces in fine fabrics, outer garments, sportswear, children's and doll clothing, crafts, etc.
- works well for gathered sleeve edges and neck openings

Preparation

- ❖ cut elastic to length required

Sewing

- ❖ oversew the elastic, adjusting the stitch width to be slightly wider than the elastic
- needle must not pierce the elastic
- ❖ after sewing, adjust the gathers evenly



TIP

Secure the beginning and end of elastic

Sew a few straight stitches backwards and forwards to secure the elastic.

TIP

Quick hem finish

- for children's or doll clothing
- ❖ sew sleeve edges with elastic before sewing seams

Sewing on Elastic, Shirring Elastic/Cord

Sewing on Wide Elastic

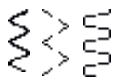

- Stitch: **Running stitch No. 4 or
Sewn-out zig-zag No. 16 or
Lycra stitch No. 17**
- Stitch length: **adjust to suit elastic**
- Needle: **size and type to suit the fabric selected**
- Thread: **cotton or polyester**
- Feed dog: **up (sewing position)**
- Presser foot: **Reverse pattern foot No. 1C**
- Needle stop: **down**

Wide Elastic

- for edges on sportswear and lingerie

Preparation

- ❖ cut elastic to length desired
- ❖ divide fabric edge and elastic into 4 equal sections and mark
- ❖ pin elastic to raw edge, matching up marks

Sewing

- ❖ stretch the elastic to fit the raw edge while sewing
- ❖ trim excess fabric close to the stitching



TIP

Gather edges first

- ❖ first sew two parallel straight stitches about 5mm apart for about 2" (5cm)
- ❖ knot the beginning of the threads
- ❖ hold bobbin thread, gather fabric
- ❖ to begin the elastic can be sewn on flat without being stretched

TIP

Preventing elastic from stretching too much

- ❖ Avoid over-stretching the elastic; adjust the presser foot pressure to suit the fabric.

Sewing on Elastic, Shirring Elastic/Cord

Elastic Edges



- Stitch: **Zig-zag stitch No. 2**
Stitch width: **approximately 5mm**
Stitch length: **1–1.5mm**
Needle: **size and type suitable for the fabric selected**
Thread: **cotton or polyester**
Feed dog: **up (sewing position)**
Presser foot: **Reverse pattern foot No. 1C**

Elastic Edges

- use on knit garments to re-form out-of-shape edges

Sewing

- ❖ guide double length of shirring elastic along the edge of the fabric, stretching the elastic slightly
- ❖ oversew the elastic with a zig-zag stitch (do not sew through the elastic, only over it)
- ❖ adjust elastic after sewing is complete to regain the correct shape and size



TIP

Prevent fabrics stretching

To prevent the fabric from stretching as it is sewn, reduce the presser foot pressure to suit the fabric.

Automatic Darning

Quick Darning of Holes or Worn Areas



- Stitch: **Simple darning program No. 22, Reinforced darning program No. 23**
Needle: **size and type suitable for the fabric selected**
Thread: **lightweight darning thread**
Feed dog: **up (sewing position)**
Presser foot: **Automatic buttonhole foot No. 3A, Reverse pattern foot No. 1C (only for Darning program No. 22)**

Simple Darning Program No. 22

replaces threads along the lengthwise grain in all fabrics

Preparation

1,2,3...

- ❖ use Reverse pattern foot No. 1C
- ❖ select Stitch Counter icon on the toolbar on the lower part of the screen
- ❖ place a piece of lightweight stabilizer under the worn area before darning if necessary

Sewing

- ❖ sew the first row and stop
- ❖ press and release the Quick Reverse button at the desired length; this programs the first length
- ❖ continue sewing; the sewing computer stops automatically

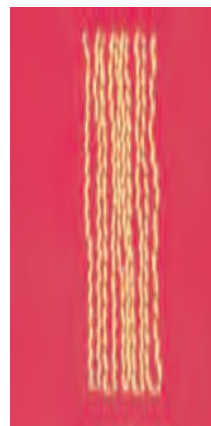

Note:

The Simple darning program No. 22 can also be done with the Automatic buttonhole foot No. 3A (see following description).

Reinforced Darning Program No. 23

replaces threads along the lengthwise and crosswise grains in all fabrics

Preparation

- ❖ use Automatic buttonhole foot No. 3A
- ❖ place a piece of lightweight stabilizer under the worn area before darning if necessary

Sewing

- ❖ insert the needle in the top left of the worn area
- ❖ sew the first vertical row
- ❖ press and release the Quick Reverse button at the desired length; this programs the first length
- ❖ continue sewing; the sewing computer stops automatically when finished

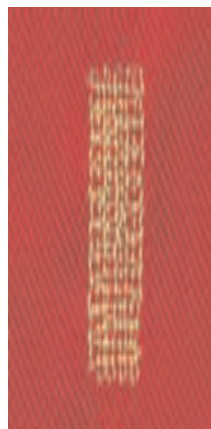

TIP

If the darning does not cover the whole worn or damaged area

Reposition the work under the foot to continue covering the worn or damaged area. Begin sewing; the program will repeat as often as desired (the length is saved).

TIP

If the darning becomes distorted

Correct with the Balance function see page 183.

Manual Darning

- Stitch: **Straight stitch No. 1**
- Needle: **size and type suitable for the fabric selected**
- Thread: **lightweight darning thread**
- Feed dog: **down (darning position)**
- Presser foot: **Darning foot No. 9 (optional accessory)**

Manual Darning

- darning holes or worn areas
- replaces threads with the lengthwise and the crosswise grains in all fabrics

Preparation

- ❖ stretch fabric into darning hoop (optional accessory) to prevent distortion
- ❖ use of the slide-on table is recommended

Sewing

- ❖ move the darning hoop smoothly by hand
- ❖ work from left to right without using pressure
- ❖ when changing direction on top and on bottom, move in curves (avoid points as this prevents holes and thread breakage)
- ❖ work in different length so that the thread is «lost» in the fabric

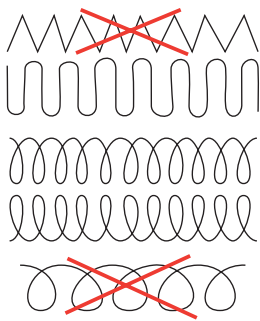

1. Stitch Over the Hole

- ❖ sew the first rows to cover the hole (not too close, sewing beyond the worn area)
- ❖ work the rows in irregular lengths
- ❖ turn work by a quarter turn – 90°

2. Cover the First Rows

- ❖ sew over the first rows – not too close for a soft finish
- ❖ turn work by a half turn –180°

3. Complete Darning

- ❖ loosely and in same direction as 2nd rows



Note:
Place suitable material under a large area.

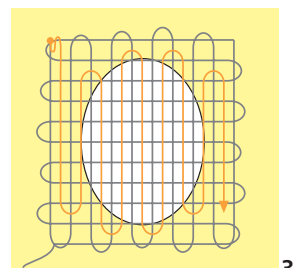
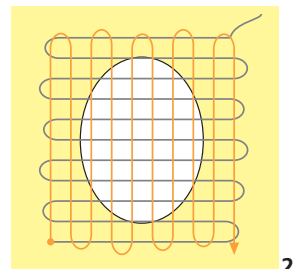
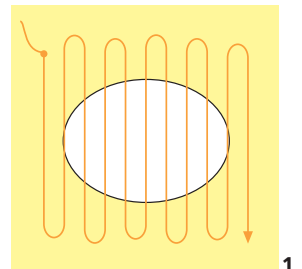

TIP

Poor stitch formation

- if the thread is lying on the right side of the fabric, the hoop is being moved too quickly
- if there are knots on the wrong side of the fabric, the hoop is being moved too slowly

TIP

Thread breaks

If thread breakage is a problem, it could be that the hoop is not being moved smoothly.

Patching Knits and Jersey



Stitch: **Jersey stitch No. 14**
Needle: **size and type suitable for the fabric selected**
Thread: **lightweight darning thread**
Feed dog: **up (sewing position)**
Presser foot: **Reverse pattern foot No. 1C**



Covering Worn or Damaged Areas

- particularly suitable for knit fabrics, lingerie

Preparation

- ❖ do not cut damaged area
- ❖ round off the edges of the patch to retain flexibility
- ❖ pin and baste to right side

Sewing

- ❖ place patch over worn area
- ❖ sew over edge
- ❖ sew a second row inside the first if required
- ❖ cut away damaged area

TIP

Knits

Use a new needle to prevent damage of the fabric loops.

TIP

Sewing stretch fabrics

- ❖ place a stabilizer under the fabric
- ❖ if necessary use a stretch needle (130/705 H-S); point slides easily between the fibers
- ❖ to prevent the stretching of the seam while being sewn, reduce the presser foot pressure to suit the fabric

Freehand Embroidery



Stitch: **Straight stitch No. 1 or Zig-zag stitch No. 2**
Needle: **size and type suitable for the fabric selected**
Thread: **embroidery thread, lightweight thread in bobbin**
Feed dog: **down (darning position)**
Presser foot: **Darning foot No. 9 (optional accessory) or Freehand embroidery foot No. 24 (optional accessory)**



Freehand Embroidery

- freehand embroidery is used for creative designing. With the Straight stitch No. 1 or Zig-zag stitch No. 2 the surface of the fabric can be covered with narrow or wide stitches
- use fine to mediumweight fabrics

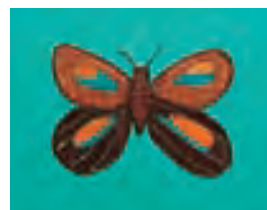

Preparation

- ❖ draw desired motif with a pencil or marker on the fabric
- ❖ place stabilizer under fabric
- ❖ stretch fabric and stabilizer into wooden embroidery hoop (optional accessory)
- ❖ use slide-on table

Note:

If a thick decorative thread is used as bobbin thread, an extra bobbin case should be purchased.

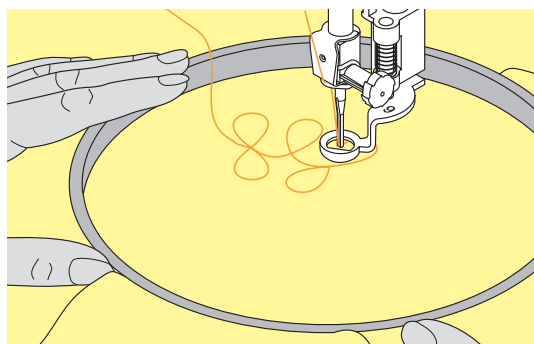

Sewing

- ❖ stitch length: set on 0 and reduce upper thread tension slightly
- ❖ use Zig-zag stitch No. 2 to cover the surface of the fabric and set stitch width according to motif
- ❖ use Straight stitch No. 1 for sewing straight lines
- ❖ it is recommended to start with a circular motion, until some practice is gained
- ❖ hold hoop with both hands and move smoothly. To move up and down is easier than embroidering sideways; turn hoop to embroider sideways
- ❖ embroider rows of stitches next to each other according to desired density
- ❖ move with regular, consistent speed, if the thread lies loose on the right side of the fabric, the stitch area was moved too fast. If there are little knots on the wrong side, the stitch area was moved too slowly

TIP

Freehand embroidery on a water-soluble stabilizer

Motifs can also be embroidered on water-soluble stabilizer. Make sure that the stitches overlap so that the edge is firmly woven. Wash out the stabilizer afterwards, appliqué the motif onto a project.

TIP

Additional designing possibilities
Use different threads and fabrics.



Bartack Program



Stitch: **Bartack program No. 24 or No. 25**
Needle: **size and type to suit the fabric selected**
Thread: **cotton or polyester**
Feed dog: **up (sewing position)**
Presser foot: **Reverse pattern foot No. 1C**

Bartack Program

- for reinforcing zippers, pocket edges, sewing on belt loops
- use for attaching ribbons to a quilt for tying

Sewing

- the sewing computer starts top left with the bartack program and automatically stops at the end of the program

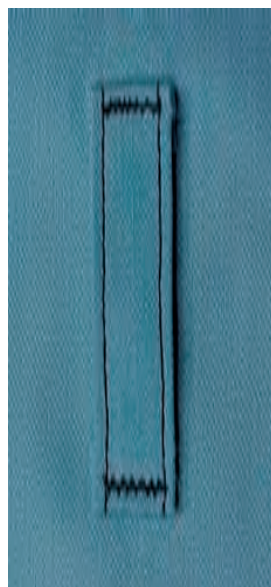

TIP

Decorative bartacks

Increase the stitch length and sew the bartack program with decorative thread as a decorative element; or combine two together at right angles to each other as decoration.

TIP

Shorten zipper

A zipper that is too long can be trimmed and reinforced by using the Bartack program No. 25.



Fly Stitches



Stitch: **Fly stitch No. 26 and No. 27**
 Needle: **size and type to suit the fabric selected**

Thread: **cotton, decorative or polyester up (sewing position)**
 Feed dog: **Reverse pattern foot No. 1C or Sideways motion foot No. 40C**
 Presser foot: **Reverse pattern foot No. 1C or Sideways motion foot No. 40C**



Fly Stitches

The fly stitch is used as reinforcement at the end of seams, e.g. pocket edges or slits

- stitch No. 26 is for mediumweight to thick fabric
- stitch No. 27 is for fine to mediumweight fabric

Sewing

- ❖ place presser foot No. 1C in the middle of the seam at the end of the slit or the pocket edge
- ❖ the fly stitch is automatically sewn from bottom to top (in reverse)
- ❖ the sewing computer stops automatically at the end



TIP

Hand-stitched effect

To get a hand-stitched effect the fly stitch can be sewn with a heavier thread.

TIP

The fly stitch can also be used as a decorative effect.



Stitch Summary **74**

Important Decorative Sewing
Information **75**

Decorative Stitches 9mm **76**

Decorative Stitches in
Combination With Functions **77**

Combining Practical and
Decorative Stitches **79**

Cross Stitches **81**

Heirloom Techniques **82**

Hemstitches **83**

Pintucks **84**

Scallops Off the Edge **87**

Corded Scallops **88**

Sideways Motion Stitches **89**

• General facts • Using templates for
manual combining • Automatic connecting
with 16 Directional Sewing

16 Directional Sewing **94**

Connecting Stitches **95**

4 Directional Sewing **96**

Decorative Stitches



Decorative Stitches

9mm, 40mm, 16 Directional Sewing and 4 Directional Sewing



Decorative Stitches, 16 and 4 sewing directions

❖ press Decorative Stitch button, 16/4 directions



Summary



Summary

- The following list of categories appears:

Category 101... = «Nature» decorative stitches, 9mm
Category 201... = «Nature» decorative stitches, 40mm
Category 301... = Cross stitches, 9mm
Category 401... = Home dec stitches, 9mm
Category 501... = Satin and quilting stitches, 40mm
Category 601... = Machine embellishment
Category 701... = Heirloom stitches, 9mm
Category 801... = Heirloom stitches, 40mm
Category 901... = «Children» decorative stitches, 9mm
Category 1015... = «Children» decorative stitches, 40mm
Category 1101... = Zodiacs
Category 16 Directions Sewing
Category 4 Directions Sewing

- for a complete list of stitches, refer to page 268-271

Important Decorative Sewing Information



Selecting Decorative Stitches

- ❖ press Decorative Stitch button
- a complete overview appears on the screen:
 - 101, ..., 301, ..., 401, ..., 601, ..., 701, ..., 901, ...
= decorative stitches 9mm (decorative stitches of up to 9mm stitch width)
 - 201, ..., 501, ..., 801, ... 1015, ..., 1101, ...
= sideways motion stitches (marked with 4 arrows); sideways motion stitches are large stitches or outline designs which are sewn with the fabric being fed sideways, as well as forward and backward
 - 4 Directional Sewing, 16 Directional Sewing:
automatic feed in 4 or 16 directions
- ❖ touch the appropriate button to select and activate the desired category
- ❖ select the desired stitch



Application of Various Decorative Stitches

Depending on the type of fabric, select simple or more complicated decorative stitches to enhance the fabric.

- ❖ lightweight fabrics
 - use simple decorative stitches for a particularly nice effect on lightweight fabric (e.g. Decorative stitch No. 101)
- ❖ mediumweight fabrics
 - simple and more complicated decorative stitches - programmed with triple straight stitch or with a few satin stitches - are particularly suitable for mediumweight fabrics (e.g. Decorative stitch No. 107)
- ❖ heavyweight fabrics
 - use more intricate decorative stitches - programmed with satin stitches - on heavyweight fabrics for outstanding decorative stitching (e.g. Decorative stitch No. 401)



Perfect Stitch Formation

- ❖ use the same needle and bobbin thread color
- ❖ use a stabilizer on the wrong side of the fabric for perfect stitch formation
- ❖ use an additional, water soluble stabilizer on the right side of pile or longfiber fabrics (e.g. wool, velvet, etc.)

Decorative Stitches

9mm

- Stitch: **Decorative stitches 9mm**
 Needle: **size and type suitable for the fabric selected**
 Thread: **cotton, decorative**
 Feed dog: **up (sewing position)**
 Presser foot: **Reverse pattern foot No. 1C, Open embroidery foot No. 20C**

Decorative Stitches

- for any material
- to decorate and embellish



1 2

Applications

Stitch Selection

- ❖ press Decorative Stitches button
- ❖ select the desired stitch folder on screen (group 100, 300, 400, 600, 700 and 900 are 9mm stitches)
- ❖ select the desired stitch

Screen

- the stitch width and length is highlighted in blue
- default settings (stitch length and width) can be altered



Altering the Stitch Width (1)

- for decorative effects and stitch adjustments (e.g. in bulky places)
- ❖ wider = turn the external stitch width knob clockwise
- ❖ narrower = turn the external stitch width knob counter clockwise
- default settings and the alterations made will be displayed on screen
- ❖ reset default settings = touch the stitch width or length bar or turn the external knobs



Altering the Stitch Length (2)

- for decorative effects and stitch adjustments (e.g. in bulky places)
- ❖ longer = turn the external stitch length knob clockwise
- ❖ shorter = turn the external stitch length knob counter clockwise
- default settings and the alterations made will be displayed on screen
- ❖ reset default settings = touch the stitch width or length bar or turn the external knobs

TIP

Saving altered default settings

- ❖ save the stitch with its altered settings in your Personal Program
- ❖ change the factory settings of the stitch permanently

• for more details on Personal Program see page 154

• for more information see page 24-25

Combining Decorative Stitches and Functions

Stitch: **Decorative stitches 9mm**
Needle: **size and type suitable for the fabric selected**
Thread: **cotton, decorative**
Feed dog: **up (sewing position)**
Presser foot: **Reverse pattern foot No. 1C or
Open embroidery foot No. 20C**

Create amazing effects by combining decorative stitches and functions.

Instructions

- ❖ select desired stitch
- ❖ select desired function
 - the altered stitch is displayed on screen
 - a single stitch can be combined with several functions

Deleting Functions

- ❖ press the external «clr» button or delete special functions individually by touching the corresponding functions on the screen



Mirroring Decorative Stitches

- ❖ touch the Horizontal Mirror Image (left/right) function
 - the stitch is mirrored left/right



- ❖ touch the Vertical Mirror Image (up/down) function
 - the stitch is mirrored in the sewing direction, up/down



- ❖ touch both Mirror functions simultaneously
 - the stitch is mirrored vertically and horizontally





Altering Decorative Stitches With Long Stitch Function (1)

- ❖ press the Long Stitch function
- the sewing computer will sew every alternate stitch
- the completely changed stitch will be displayed on the screen



Stretching Decorative Stitches With Pattern Extend Function (2)

- ❖ touch the Pattern Extend function once or more
- the selected stitch is extended (i.e. stretched) two- to fivefold
- some stitches have limited extension capability, and thus cannot be stretched to 3 to 5 times their previous size



Sewing With a Double, Triple or Wing Needle (3)

- ❖ on inserting the specialty needle activate the Security Program

• for more details on Security Program see page 32 ●●●●●●●●

- when selecting the stitch, the stitch width is automatically limited according to the needle chosen
- the best effects are achieved with simple stitches



Balance (4)

- use the Balance function for various effects (stitch variations)

• for more details on the Balance function see page 183-184 ●●●●●●●●



1



2

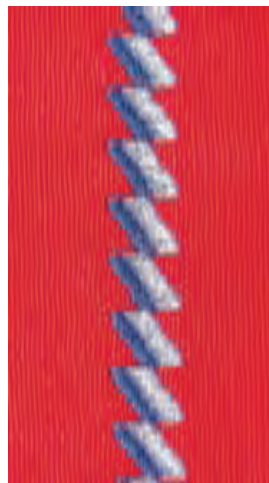

3

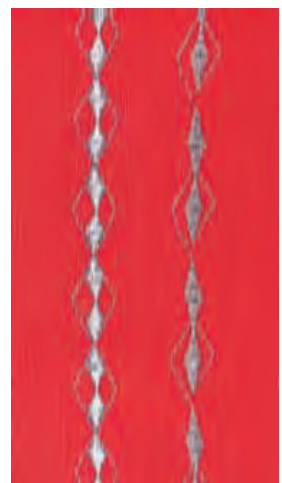

4

TIP

Add «Pattern End»/«Pattern Repeat»

- ❖ touch the Pattern End button on head frame: the sewing computer will stop at the end of an individual stitch or the active stitch in a combination
- ❖ touch the Pattern Repeat 1-9x function on the screen: the sewing computer will stop on completion of the number of single repeats entered

Practical and Decorative Stitches in the Combi Mode

Stitch: **Decorative and Practical stitches 9mm**
 Needle: **size and type suitable for the fabric selected**
 Thread: **cotton, decorative**
 Feed dog: **up (sewing position)**
 Presser foot: **Reverse pattern foot No. 1C or
 Open embroidery foot No. 20C**



- ❖ select «Combi Mode»
- the Combi Mode opens, and is ready to create stitch combinations



Note:

Most of the practical and decorative stitches can be combined, except for the following special programs:

Securing program No. 324

Securing stitch No. 5

Basting No. 21

Darning No. 22 and No. 23

Bartacks No. 24 and No. 25

Fly stitches No. 26 and No. 27

Stitches in the buttonhole category Nos. 51 - 63



Combining Practical and Decorative Stitches

- ❖ select desired stitch
- stitch appears in the stitch display
- ❖ select another stitch
- ❖ continue in this way until the desired stitch combination is completed

- Preview of Combination see page 160



Example of a Stitch Combination

- ❖ Machine Embellishment stitches: touch stitch No. 655 once
- ❖ open Practical Stitches window and touch Straight stitch No. 1 once
- ❖ open Decorative Stitches window and touch stitch No. 606 in Machine Embellishment stitches once
- ❖ open Practical Stitches window and touch Straight stitch No. 1 once
- ❖ the stitches alternate continuously as you sew



Example of a Stitch and Function Combination

- ❖ touch stitch No. 656 once
- ❖ touch stitch No. 656 again and activate Vertical Mirror Image function to mirror the stitch in the sewing direction
 - the stitch is mirrored in the sewing direction
 - the stitches alternate in their original and mirrored form as you sew



Stitch Combination as Single or Multiple Repeat

- ❖ create stitch combination
- ❖ touch «Pattern Repeat 1 - 9» one or more times (the corresponding number from 1 - 9 appears)
 - sewing computer will stop automatically at the end of the programmed number of stitch combination repeats



Correcting a Combination



Inserting Stitches

- stitches are always inserted above the cursor
- to insert a stitch at the beginning of a stitch combination, move the cursor upwards, using the scroll arrow
 - ❖ activate desired place = select desired stitch in the Stitch Altering Area or scroll to the stitch
 - ❖ select new stitch
- stitch is inserted above the cursor



Deleting Stitches

- stitches are always deleted above the cursor
- ❖ activate desired place by selecting desired stitch in the Stitch Altering Area or scroll to the stitch
 - ❖ touch «Delete»
- stitch is deleted

• «Saving Combinations» see page 158

TIP



Mirroring complete combination left/right

- ❖ touch Multifunction button
- ❖ touch «Mirror Combination»
 - the complete combination is mirrored left/right

TIP



Add Securing function (4 small securing stitches)

There are various options for automatically securing stitches:

1. touch «Securing» before beginning to sew: securing stitches are stitched at beginning of stitch combination
2. programming a function within a stitch combination: the desired stitches are secured accordingly

Cross Stitches

Stitch: **Cross stitches No. 301 - 314**
Needle: **size and type suitable for the fabric**
Thread: **cotton, decorative**
Feed dog: **up (sewing position)**
Presser foot: **Reverse pattern foot No. 1C or
Open embroidery foot No. 20C**

- cross stitching is a traditional technique, and extends the range of decorative stitches
- if the cross stitches are sewn on fabric with a linen texture, they acquire a hand-stitched effect and look like hand-stitched cross stitching

Application

- for home furnishings
- for trimmings on garments
- for embellishing in general

Sewing

- ❖ Cross stitches Nos. 301 - 314 can be stitched and combined like any other decorative stitches

Sewing Trims

- ❖ select cross stitch
- ❖ stitch a row, using the seam guide or slide-on table seam guide
- it is important to stitch the first row in a straight line, as it will serve as a reference for the rows that follow
- ❖ select a new stitch
- ❖ stitch a second row next to first at a distance of one presser foot's width, or using the seam guide
- ❖ repeat for the following rows of stitching



TIP

Use cotton embroidery thread for cross stitching
Stitch appears fuller.

Heirloom Techniques / Sewing Lace

Heirloom Sewing

- is one of the oldest and most traditional needlework techniques
- embellishments such as lace of a matching shade are sewn on white cotton or linen to be used in making home furnishings and garments
- heirloom embroidery includes - among others - techniques like hemstitching, attaching and inserting lace, padded satin scallops



Attaching and Inserting Lace

- Stitch: **Zig-zag No. 2**
Needle: **size and type suitable for the fabric selected**
Thread: **cotton or decorative**
Feed dog: **up (sewing position)**
Presser foot: **Reverse pattern foot No. 1C or Edge stitch foot No.10C (special accessory)**

Preparation

- ❖ use the same color thread as the lace
- lace which has been spray-starched before stitching is easier to use

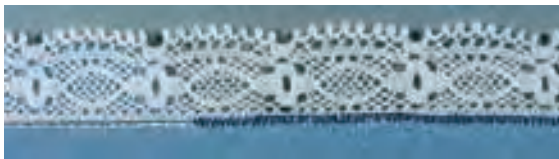

Attaching Lace to Fabric

- ❖ place lace on right side of the fabric, edges overlapping at least 3/8" (1cm) (= seam allowance) and pin
- lace header lies on the fabric
- ❖ use Straight stitch No. 1 to attach lace
- ❖ press seam allowance back to wrong side of fabric
- ❖ from the right side, use a narrow zig-zag (stitch width approx. 1 1/2 - 2 1/2, length approx. 1/2) to sew on lace. Stitch along the edge of the lace so that the stitches enclose the edge
- ❖ trim excess fabric on wrong side

Attaching Lace to Lace

- ❖ place pieces of lace next to each other (edges touching exactly)
- ❖ use a fine zig-zag stitch (stitch width approx. 1 1/2 - 2, length approx. 1/2) to sew the pieces of lace together. The needle swing should alternately catch the two lace edges. Use the Edge stitch foot No. 10



Inserting Lace into Fabric

- ❖ pin or baste lace onto fabric. Use Straight stitch No. 1 to stitch along both edges
- ❖ carefully slit open the fabric in the center between the seam lines
- ❖ press the seam allowances back to the wrong side of the fabric
- ❖ from the right side of the fabric, use a fine zig-zag (stitch width approx. 1 1/2 - 2, length approx. 1/2) along both lace edges to enclose them
- ❖ trim excess fabric on wrong side



Entredeux

Attaching Entredeux to Fabric

- ❖ place Entredeux on fabric, right sides together, raw edges together
- ❖ stitch Entredeux to fabric using straight stitch, Edge stitch foot No. 10 (special accessory), guiding the guide in center of foot along seam allowance bead in Entredeux
- ❖ trim seam allowance to 1/8" (3mm)
- ❖ overcast raw edge of Entredeux/fabric seam with a narrow zig-zag stitch (stitch No. 2, stitch width 2mm, stitch length 1.5mm)

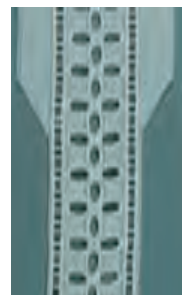

Attaching Entredeux to Lace, etc.

- ❖ trim away seam allowance of Entredeux along one bead only
- ❖ follow technique lace to lace as described above

Heirloom Techniques / Hemstitching

- Stitch: **Hemstitch Nos. 701, 702, 709 - 711, 713, 720, 721, 723, 725, 726, 732, 742**
Needle: **Wing needle, Double wing needle**
Thread: **cotton or decorative**
Feed dog: **up (sewing position)**
Presser foot: **Reverse pattern foot No. 1C or Open Embroidery foot No. 20C**

Hemstitches

- use the wing needle to achieve excellent open effects easily
- loosely woven, light- to mediumweight woven fabrics in which the penetrating needle can easily push the threads apart are especially suitable for hemstitching
- for home furnishings and garments

Preparation

- ❖ use fusible stabilizer on wrong side of fabric to reinforce it
- depending on fabric and required effect, use more than one layer of stabilizer
- ❖ insert wing needle or double wing needle and activate appropriate needle limitation in Security Program

• for more details on Security Program see page 32 ●●●●●●●●

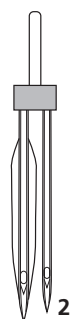
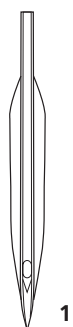

Using the Wing Needle (1)

- the «normal» wing needle can be used for any hemstitching
- ❖ select a hemstitch and sew

Using the Double Wing Needle (2)

- the wing-needle part of the special double needle creates a hole effect, while the universal-needle part creates a normal straight stitch effect
- ❖ select desired stitch (e.g. Triple zig-zag No.7) and stitch first row
- ❖ turn fabric and stitch second row. The needle should penetrate the holes of the first row

Pulling Threads Out (3)

- ❖ for an even more pronounced hand-stitched effect, withdraw threads of the fabric before starting to hemstitch
- ❖ you may wish to spray-starch the fabric and press carefully before beginning stitching
- ❖ the hemstitches are sewn next to the «gaps» left by the withdrawn threads
- to fagot the threads, the needle must alternately penetrate the fabric and the gap or ditch created by withdrawing the threads

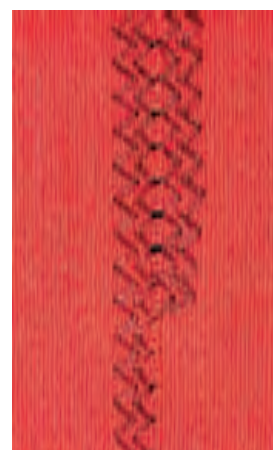
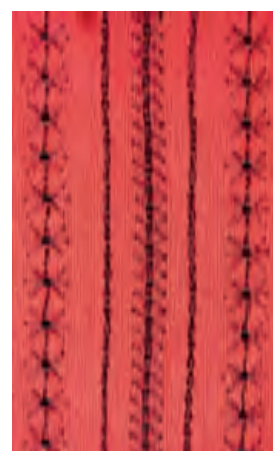

Heirloom Techniques / Pintucks

- Stitch: **Straight stitch No. 1**
Needle: **Double needle 1-4mm, depending on the Pintuck presser foot used and the fabric**
Thread: **cotton or decorative**
Feed dog: **up (sewing position)**
Presser foot: **Pintuck feet No. 30 (3 grooves), No. 31 (5 grooves), No. 32 (7 grooves), or No. 33 (9 grooves) (all the feet are special accessories)**

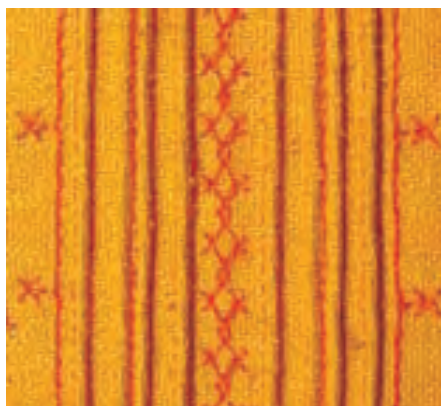

Stitching Pintucks

- this technique reduces the size of the fabric area (allow for enough fabric)
- pintucks are narrow stitched folds which are normally sewn on the fabric before cutting out the pieces for garments or other sewing projects
- for embellishing, or in combination with other heirloom embroidery techniques

Pintuck Presser Feet

- No. 30 (3 grooves) = 4mm double needle: for heavyweight fabrics
- No. 31 (5 grooves) = 3mm double needle: for medium- to heavyweight fabrics
- No. 32 (7 grooves) = 2mm double needle: for light- to mediumweight fabrics
- No. 33 (9 grooves) = 1 or 1.6mm double needle: for very light fabrics (uncorded pintucks)

Corded Pintucks

- pintucks may be sewn with or without cord
- cord pintucks for a raised effect and texture
- choose a cord that fits well into the grooves of the selected pintuck foot
- the cord must be colorfast and shrinkproof

Note:

Sewing pintucks on fabric causes fabric width to reduce. Allow extra fabric for this technique.



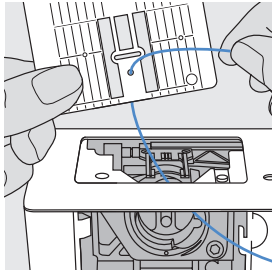

Inserting the Cord (gimp cord)

- ❖ remove stitch plate from sewing computer (see page 17)
- ❖ open bobbin cover
- ❖ thread cord from underneath plate through the bobbin area and the hole in stitch plate
- ❖ replace stitch plate

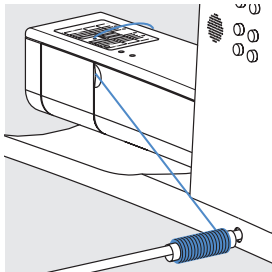

- ❖ close bobbin cover
 - the cord should feed freely - guide it through the small opening in the bobbin cover
- ❖ place the cord spool on the arm of the free hand system (presser foot lifter)
- ❖ check that the cord runs smoothly

Threading the Needle

- ❖ insert double needle
- ❖ activate the double needle limitation (corresponding to needle size used) in the Security Program

• for more details on Security Program see page 32

- ❖ thread both needles

• for more details on Threading the Double Needle see page 16

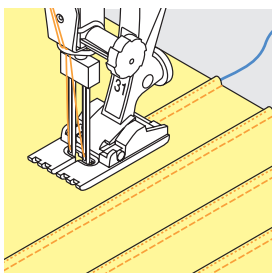

Stitching the Pintucks

- ❖ stitch first tuck - you may want to mark the line first
 - the filler cord will automatically feed into the pintuck
- ❖ turn work if required
- ❖ place first pintuck in one of the side grooves in the presser foot (depending on the desired distance)
- ❖ stitch second pintuck
 - stitch additional pintucks parallel to these two





Stitching Corners

- with a double needle the fabric cannot simply be pivoted at corners. Corners must therefore be sewn in several steps:
 - ❖ with the double needle in the fabric, turn the handwheel until the needles are just above the fabric (the eye appears, but the point is still in the fabric)
 - ❖ pivot the fabric halfway into the corner (45°), make one stitch, bring the needle back to the same position (just above the fabric)
 - ❖ pivot the fabric another 45° and continue stitching
- for a pointed corner, simply repeat the steps until the desired angle is reached



Shaped Pintucks

- in addition to straight lines, pintucks may also be stitched in wavy lines as desired



Combining Decorative Stitches and Pintucks

- ❖ if you wish to place rows of decorative stitching directly between pintucks, use Reverse pattern foot No. 1C to stitch them before sewing the pintucks
- ❖ use a removable stabilizer under the work and remove it after the decorative stitching is completed
- ❖ stitch pintucks on the left and right of the decorative stitching as required and as described above



TIP

Seam guide

Use the seam guide for evenly spaced pintucks, especially for more widely spaced ones.

Heirloom Techniques / Scallops Off the Edge

Stitch: **Padded satin stitch No. 416**
Needle: **size and type suitable for the fabric selected**
Thread: **cotton or decorative**
Feed dog: **up (sewing position)**
Presser foot: **Open embroidery foot No. 20C or Embroidery foot No. 6 (special accessory)**

Padded Satin Scallops

- an «airy» finish for any finished edge
- for garments, table and bed linens

Preparation

- ❖ to create padded satin scallops «in the air», i.e. off the edge, place watersoluble or tear-away stabilizer under the fabric, allowing to protrude clearly at the edge
- ❖ pin or baste stabilizer to fabric
- ❖ place filler cord spool (e.g. Perle cotton No. 8) on FHS lifter
- the filler cord, which stabilizes the scallops, should be the same color as the thread used to make the scallops, as well as be colorfast and shrinkproof
- ❖ thread the filler cord from underneath the stitch plate through the hole in the stitch plate

• for more information on Inserting Gimp Cord see page 85 ●●●●●●●●●●

Stitching

- ❖ stitch the first row of scallops
- the scallops always begin and end on the fabric edge, with the curve being stitched on the stabilizer
- if the scallops do not begin and end on the fabric, they will not be attached to it
- ❖ add 2 to 3 more rows of scallops as desired
- with additional rows, the scallop begins and ends in each case in the middle of the scallop of the previous row
- if the scallop stitch does not begin or end in the middle of the scallop of the previous row, the rows will not hold together
- ❖ carefully remove the stabilizer on completion of the stitching

TIP

Perfect sewing results

As the padded satin scallop off the edge technique requires some practice, always sew a test.

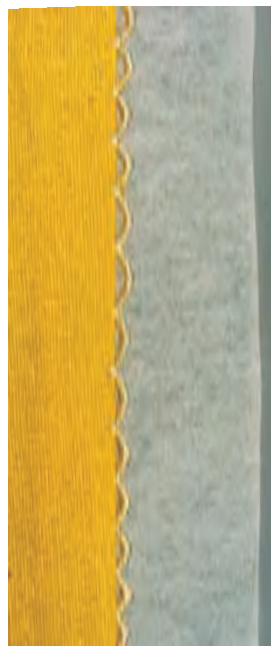
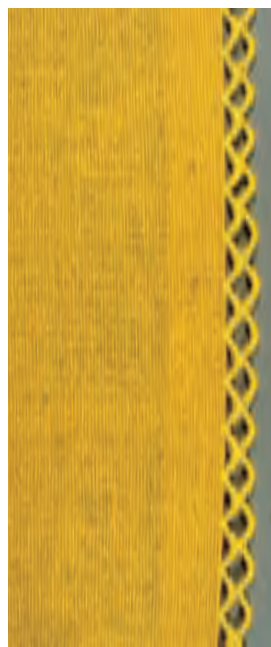

Heirloom Techniques / Corded Scallops

Stitch: **Satin scallop stitch No. 507, 508**
Needle: **size and type suitable for the fabric selected**
Thread: **cotton or decorative**
Feed dog: **up (sewing position)**
Presser foot: **Sideways motion foot No. 40C, and Open Embroidery foot No. 20C, or Embroidery foot No. 6 (special accessory)**

Corded Scallops

- a decorative edge finish for garments and table and bed linens

Pre-stitching

- ❖ place stabilizer under fabric edge
- ❖ with foot No. 40C, stitch a row of satin scallops approx. 3/8" (1cm) from the edge, using the seam guide or slide-on table seam guide to help you stitch straight

Trim Fabric

- ❖ once all the satin scallops are completed, carefully trim excess fabric

Overstitching Corded Scallops

- ❖ insert presser foot No. 20C, and place filler cord spool (e.g. Perle cotton No. 8) on the FHS lifter
- the filler cord, which stabilizes the scallops, must be the same color as the thread used to make the scallops, as well as colorfast and shrinkproof
- ❖ use Zig-zag stitch No. 2 (stitch width approx. 5, length approx. 1/2 - 1) to overstretch the scallops, guiding the filler cord along the stitching
- the needle swing will alternately penetrate the scallop stitching and the fabric just next to the cord
- ❖ slightly narrow the stitch width at the end of each scallop. Sew last few stitches to end of scallop, turn fabric slightly (with the needle down), then sew a few stitches, and widen stitch width again to sew the broad part of the scallop



Corded scallops



Pre-stitching corded scallops



Overstitching corded scallops

- for more information on Sideways Motion Stitches see page 90



TIP

Simplified overstitching of the scallops

- ❖ reduce sewing speed when overstitching corded scallops (using Motor Speed function)
- ❖ activate the Needle Stop Down function which is a big help when overstitching

TIP

Reinforced Satin Scalloped Edge

Use double cord.

Sideways Motion Stitches

In General



Sideways Motion Stitches

- sideways motion stitches are large stitches which are sewn with the fabric being fed sideways, as well as forwards and backwards
- ❖ touch desired stitch to activate it
- sideways motion stitches are depicted with 4 arrows in the Stitch Altering Area
- start (green point) and end (read cross) are visible in the Stitch Altering Area

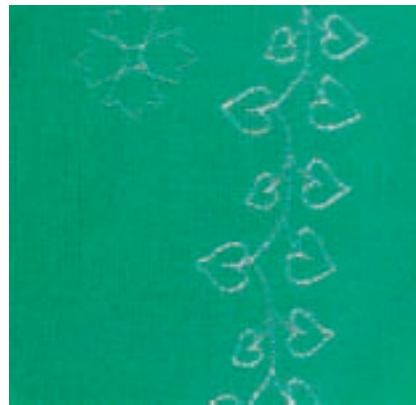

- with some individual stitches (e.g. Single motif No. 218), the sewing computer stops automatically
- other stitches (e.g. No. 808) can be stitched continuously

Templates as Sewing Aid

- the templates enclosed with the owner's manual help to position the stitches on the fabric
- all sideways motion stitches are printed in their original size on the template
- the starting point of the individual stitches is marked with a circle, the end with a cross. The beginning and end are also provided with a hole (so that they can be accurately marked on the fabric)
- the starting and end are also shown on screen, once the stitch is selected, in the Stitch Altering Area
- the sewing direction is indicated by a presser foot symbol and thin guide lines
- the presser foot must always run parallel to the guide lines
- ❖ place the template on the fabric to mark the starting point of the desired stitch





Sewing Sideways Motion Stitches

- ❖ use the slide-on table to enlarge sewing area
- ❖ insert needle at starting point (pay attention to sewing direction on template)
- ❖ position fabric so that guide lines on template run parallel to presser foot, then remove template
- ❖ stitch: the sewing computer will stitch the selected stitch
 - make sure that the fabric feeds freely and evenly - it must not be inhibited (must not bump into anything, or drag)
 - it is important to let the sewing computer stitch without «helping» it by pushing, pulling or holding the fabric back
 - before starting to stitch, it might be helpful to draw a line on the fabric in the same direction as the template lines to serve as a guide for parallel stitching

Combining Sideways Motion Stitches and Functions

- ❖ sideways motion stitches can be combined with all functions active on the screen (e.g. «Mirror Image»)
- the size of most sideways motion stitches cannot be altered (noticeable by different color of Stitch Width and Stitch Length Indication)



Balance

- depending on type of fabric, stabilizer and thread quality, the stitches may differ slightly from the original
- use the Balance function to match the selected stitch to the fabric used

- for more information on Balance see page 184 ●●●●●●●●●●

TIP

Test sewing

It is always a good idea to test sew with the materials you intend to use - fabric, stabilizer, and threads.

Sideways Motion Stitches

Combining Manually With Templates

- Stitch: **Sideways motion stitches**
Needle: **size and type suitable for the fabric selected**
Thread: **cotton or decorative**
Feed dog: **up (sewing position)**
Presser foot: **Sideways motion foot No. 40C**

Using Templates to Position Sideways Motion Stitches

- ❖ use templates to position the sideways motion stitch on the desired place on the fabric
- ❖ transfer the starting point (circle) of the stitch to the fabric



Sewing

- ❖ use the slide-on table to enlarge the sewing area
- ❖ select sideways motion stitch in Single Mode
- ❖ place sideways motion presser foot on the fabric as shown on the template so that needle will go through starting point of the stitch
- ❖ stitch

Continuous Sideways Motion Stitch as Single Repeat

- ❖ touch Pattern Repeat 1-9x function once («1» appears in display): sewing computer stops automatically

Using the Template to Add an Additional Sideways Motion Stitch

- ❖ use template to add another sideways motion stitch: position template on fabric once more, mark starting point again, select sideways motion stitch, place presser foot as shown on template and stitch

TIP



Automatic Thread Cutter

Since threads are secured automatically when sewing sideways motion stitches, it is particularly convenient after stitching to cut off threads directly using the Automatic Thread Cutter function.



Sideways Motion Stitches

Automatic Connection With 16 Directional Sewing

- Stitch: **Sideways motion stitches**
Needle: **size and type suitable for the fabric selected**
Thread: **decorative**
Feed dog: **up (sewing position)**
Presser foot: **Sideways motion foot No. 40C**

Automatic Connection of Sideways Motion Stitches With 16 Directional Sewing

- sideways motion stitches can be connected automatically using the 16 Directional Sewing in Combi Mode

Using Templates to Define Spacing

- ❖ place template of first sideways motion stitch (e.g. No. 205) on fabric
- ❖ mark start and end point of first stitch
- ❖ place second stitch using the 16 Directional Sewing template (same sewing direction as first stitch)
- the presser foot icon, which shows in the sewing direction, is placed on the end point of the first stitch
- start point of second stitch must be placed on one of the 16 sewing directions and one of the spacing points (point of arrow)
- ❖ note direction to start point of next stitch (e.g. No. 205) and count number of spaces in-between (9mm each)

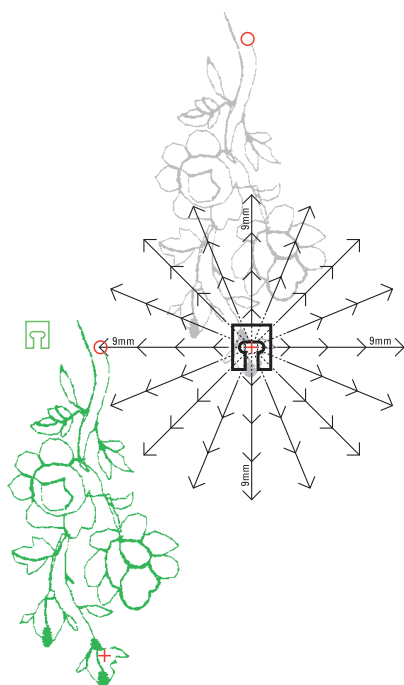

Programming Sideways Motion Stitches and Spaces

- ❖ select desired sideways motion stitch (e.g. No. 205) in Combi Mode
- ❖ select «16 Directional Sewing»
- ❖ select Straight stitch No. 39, default setting with stitch length 1 (sews only every 3rd stitch = 3mm)
- ❖ using the arrow on-screen buttons, enter direction as noted before
- ❖ activate Long Stitch function (sews only every 9th stitch)
 - 1 Straight stitch No. 39 (stitch length 1) in combination with Long Stitch function gives a 9mm space
- ❖ enter number of straight stitches (= connecting stitches) according to spaces counted
- ❖ remember to delete Long Stitch function!
- ❖ select second sideways motion stitch
- ❖ to sew a single repeat activate Pattern Repeat 1-9x function («1» appears)



Sewing the Stitch Combination

- ❖ place sideways motion presser foot on fabric as shown on template so that needle will go through starting point of stitch
- the sewing computer will stitch the first stitch first, then switch automatically to connecting stitches, and stop automatically at the end of the second stitch
- ❖ since the sideways motion stitches are secured automatically, the connecting stitches can be cut away when the stitching is completed



Correcting a Combination



Inserting Stitches

- stitches are always inserted above the cursor
- to insert a stitch at the beginning of a stitch combination, move the cursor upwards, using the scrolling arrow
- ❖ activate desired place by selecting the desired stitch in the Stitch Altering Area or scroll to it
- ❖ select new stitch
- the stitch will be inserted above the cursor

Deleting Stitches

- stitches are always deleted above the cursor
- ❖ activate desired place by selecting desired stitch in the Stitch Altering Area or scroll to it
- ❖ touch «Delete»
- stitch is deleted



- «Saving Combinations» see page 158 ●●●●●●●●



- For more information on Preview of Combination see page 160 ●●●●●●●●



Automatic Thread Cutter

Since threads are secured automatically when sewing sideways motion stitches, it is particularly convenient after stitching to cut off threads directly using the Automatic Thread Cutter function.

16 Directional Sewing

- Stitch: **Straight stitch No. 39 / Zig-zag stitch No. 40**
Needle: **size and type suitable for the fabric selected**
Thread: **cotton or decorative**
Feed dog: **up (sewing position)**
Presser foot: **Sideways motion foot No. 40C**



16 Directional Sewing

- sew automatically in 16 directions without turning fabric
- for many decorative projects
- for quilting without turning the fabric



Screen Display

- ❖ select «16 Directional Sewing» screen display
- ❖ touch straight stitch or zig-zag
- ❖ a presser foot symbol with the 16 sewing directions all around it appears in the middle of the screen
- ❖ use the right or left arrow on-screen button to change direction one step at a time

Straight Stitch No. 39

- ❖ Straight stitch No. 39 sews only every third stitch
- the default setting for stitch length is 1 (= 3mm) and is infinitely variable from 0 - 1 (= 0 - 3mm)



- ❖ activate Long Stitch function in addition: the sewing computer sews every 9th stitch (stitch length default setting 1 is 9mm)

Zig-zag Stitch No. 40

- stitch length is preprogrammed for satin stitching and is infinitely variable from 0 - 1mm
- stitch width is adjustable from 0 - 9mm

Sewing

- ❖ select desired stitch
- adjust stitch width and length if required
- ❖ touch arrow on-screen button to set sewing direction
- the sewing computer will sew the selected stitch in the selected direction displayed

Changing Direction

- ❖ stop the sewing computer when the desired length has been stitched
- ❖ touch arrow on-screen button to change sewing direction
- ❖ stitch

Connecting Stitches

Stitch: **Straight stitch No. 39**
 Needle: **size and type suitable for the fabric selected**
 Thread: **cotton or decorative**
 Feed dog: **up (sewing position)**
 Presser foot: **Sideways motion foot No. 40C**

16 Directional Straight Stitches as Connecting Stitches

- particularly suitable for scattering motifs over large areas
- connecting individual motifs, sideways motion stitches, or monogrammed letters
- connecting threads are removed after sewing



Straight Stitch With Long Stitch Function

- straight stitch with stitch length 1 default setting sews only every third stitch (= 3mm)
- ❖ if Long Stitch function added, the sewing computer will sew every 9th stitch (= 9mm)
- stitch length is infinitely variable



Sewing and Freely Combining

- ❖ select decorative stitch and sew once (first touch Pattern Repeat 1-9x function once)
- ❖ select Straight stitch No. 39
- ❖ use the arrow on-screen buttons to determine sewing direction
- ❖ touch Long Stitch function
- ❖ sew connecting stitches (sewing computer will sew the selected long straight stitch in the direction shown)
- ❖ touch «Pattern End» button on head frame
- sewing computer stops automatically once the stitch has been completed
- ❖ do not forget to delete Long Stitch function!

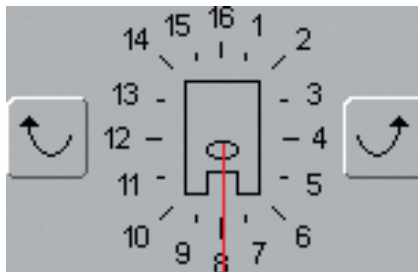

- ❖ select decorative stitch and sew once (first touch «Pattern Repeat 1-9x» once)
- ❖ select straight stitch, determine new sewing direction using the arrow on-screen buttons, reactivate Long Stitch function, and sew connecting stitches again, etc.



Creating a Combination in Combi Mode

- instead of freely connecting stitches, the stitches may be programmed with the connecting stitches in Combi Mode
- the programming of connected stitches is the same as for connecting sideways motion stitches or monogrammed letters

Note:

Activate Securing function to secure motifs at beginning and end. This will ensure that the motif stays in place once the connecting threads are clipped.



more information on:

- Connecting Sideways Motion Stitches on page 92
- Connecting Monogrammed Letters on page 105
- Saving Combinations on page 158

4 Directional Sewing

Stitch: **Stitch Nos. 41 - 48**
 Needle: **size and type suitable for the fabric selected**
 Thread: **cotton or decorative up (sewing position)**
 Feed dog: **up (sewing position)**
 Presser foot: **Sideways motion foot No. 40C**



4 Sewing directions

- 4 directional automatic sewing without turning fabric
- sewing decorative squares
- appliquéing squares
- sewing patches on garments, especially on pants legs, sleeves, etc.

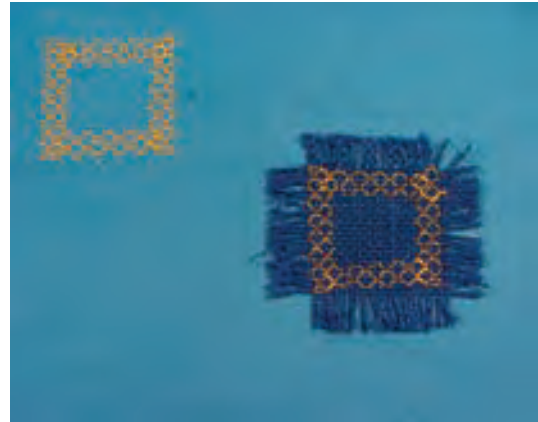

Screen Display

- ❖ select «4 Directional Sewing» screen display
- 8 different stitches are available to you:
 - No. 41 Straight stitch
 - No. 42 Zig-zag stitch
 - No. 43 Jersey stitch
 - No. 44 Running stitch
 - No. 45 Double overlock
 - No. 46 Blanket stitch
 - No. 47 Super stretch
 - No. 48 Honeycomb

- a presser foot symbol with the 4 sewing directions arranged around it appears in the middle of the screen
- use the right or left arrow on-screen button to change direction one step at a time
- stitch length can only be altered for forward and reverse stitching

Preparation

- ❖ place square on fabric, pin and baste if required
- ❖ first place double-sided fusible stabilizer under square, then press onto fabric

• for more information on preparation with double-sided fusible stabilizer see «Preparation of Appliqué» on page 143

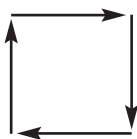

Sewing on a Square

- ❖ select desired stitch
- it is easiest to sew the square on clockwise
- ❖ sew one side with the needle swing stitching alternately into the square and just off the square into the fabric
- ❖ touch arrow on-screen buttons to change sewing direction
- ❖ sew next side, etc.



BERNINO

Alphabet Summary **98**

Important Lettering
Information **99**

Combining Lettering (9mm) **100**

General Monogramming
Information (Sideways Motion) **103**

Monogram Size 1 **104**

Monogram Sizes 2 and 3 **107**



G



Lettering

Alphabet Summary



Alphabets

❖ press Alphabet button

A

Summary



Alphabet Summary

- Alphabet summary appears



Block



Double Block



Script (Italics)



Monograms 30/20/15mm
(sideways motion)

• for more information on Full Stitch Summary
see page 272-273

Important Lettering Information

Lettering – Alphabets, Numbers, Punctuation Marks

- 4 different alphabets are available
- each of the alphabets can be sewn in two different sizes as well as in lower case (apart from the monograms)
- the monogram letters alphabet is available in three different sizes

Application

- for names, monograms and addresses
- for words and texts
- for labeling quilts (quilt labels)
- for labeling (labels)



A



Selecting Alphabets

- ❖ press Alphabet button
- Alphabet folders appear on screen:
 - Block (9mm)
 - Double Block (9mm)
 - Script (Italics) (9mm)
 - Monograms 30/20/15mm (sideways motion)
- ❖ touch one of the buttons to select
- desired alphabet is activated



On-screen Letter Selection

- scroll up and down to view all capital letters, numbers, punctuation marks and special characters
- ❖ touching the «A/a» on-screen button changes to lower case

Perfect Stitch Formation

- ❖ use the same color for upper and bobbin threads
- ❖ use stabilizer on the wrong side to reinforce sewing project
- ❖ use additional water soluble stabilizer on the right size on pile and long fiber fabric (e. g. wool, velvet, etc.)
- ❖ use simpler letters, programmed with straight stitches (like Double Block lettering), on lightweight fabrics, and satin stitch programmed lettering (like monograms) on heavyweight fabrics for decorative accents

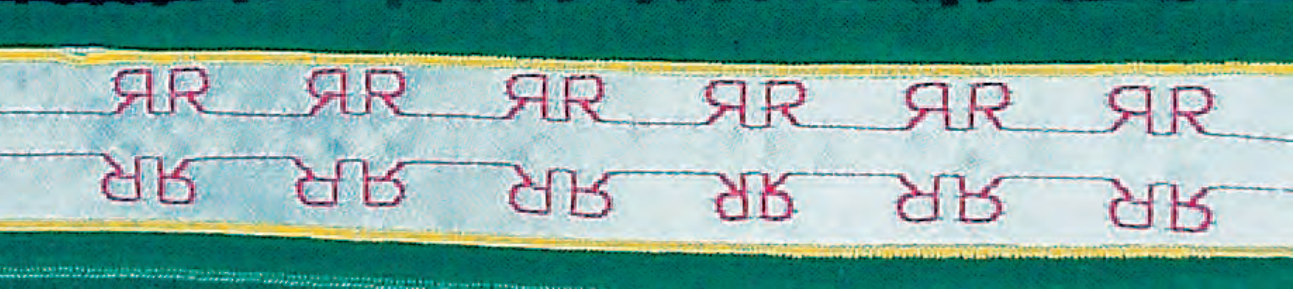

Combining Lettering and Functions



Change Size

- ❖ touch Alphabet Size button: the field with number «2» is blue
 - the letter size is reduced to 6mm
- ❖ touch «Alphabet Size» again to reactivate the larger size (field with number «1» is blue)



Select Lower Case

- ❖ select function before programming the lettering
- ❖ touch Lower Case/Upper Case button
 - the field is blue, meaning that Lower Case is active
- ❖ touch Lower Case/Upper Case button again
 - Upper Case is reactivated



Mirroring Lettering

- ❖ touch «Horizontal Mirror Image (left/right)»
 - the letter is mirrored horizontally
- for special effects «Vertical Mirror Image» can be selected



• for more information on Mirror Combination left/right see page 162



Using Pattern Extend to Stretch Lettering

- ❖ touch «Pattern Extend» one time
 - selected stitch or pattern is stretched by 2 times its original size



Sample of Combination of Lettering and Functions

- ❖ open «Combi Mode»
- ❖ select Script, and touch capital **B**
 - capital **B** is displayed in Stitch Altering Area
- ❖ select Lower Case function
- ❖ select the letters **e, r, n, i, n, a** in lower case and in that order
 - «Bernina» is displayed in Stitch Altering Area



Pattern Combination as Single or Multiple Repeat

- ❖ create pattern combination
- ❖ touch «Pattern Repeat 1-9x» button one or more times (numbers 1-9 appear)
 - sewing computer stops automatically after completing selected number of patterns



Combination Sub-divider

- Combination Sub-divider is used to stitch a text, e.g. an address, in subsequent lines instead of in one continuous line
- ❖ insert «Combination Sub-divider» at the desired places
- ❖ stitch, the sewing computer stops automatically at the end of the first combination part
- ❖ place fabric again
- ❖ continue to stitch, the sewing computer stops automatically at the end of the second combination part
- ❖ repeat as often as required

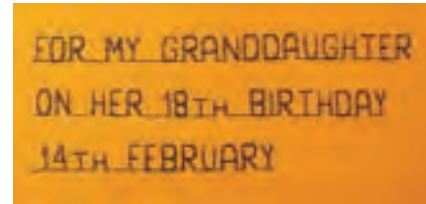

Note:

For accurate placement of the lettering in equally spaced lines, draw a guide line on the fabric. For centered texts, sew it out first to measure it, then draw the guide lines.

A

Correcting Combinations



Inserting Letters

- a letter is always inserted above the cursor
- cursor must be scrolled up (arrow) to insert an additional letter at the beginning of lettering
- ❖ activate desired place by selecting required letter in Stitch Altering Area or scroll to it
- ❖ select new letter
- letter is inserted above cursor

Deleting Letters

- ❖ a letter is always deleted above the cursor
- ❖ activate desired place by selecting required letter in Stitch Altering Area, or scroll to it
- ❖ touch «Delete»
- letter is deleted



- «Saving Combinations» see page 158

TIP



Adding Securing function (4 small securing stitches)

There are different ways to automatically secure stitching:

1. touch function button before starting to sew to secure stitching at the beginning
2. program function within a combination to secure accordingly

General Monogramming Information

Sideways Motion



Monograms (sideways motion)

- sideways motion stitches are large stitches or patterns which are sewn with the fabric being fed sideways, as well as forward and backward
- monograms (sideways motion) are represented by 4 arrows top left in the Stitch Altering Area
- start (green point) and end (red cross) are visible in the Stitch Altering Area



Monogram Sizes

- lettering size 1 is 30mm
- when starting the monogramming program, lettering size 1 is normally activated
- monograms in size 1 are individual letters, which means that the sewing computer secures and stops after each letter
- the templates included with the owner's manual contain size 1 monograms

- lettering size 2 is 20mm
- ❖ touch Alphabet Size button: the field with number «2» is blue
- size 2 monograms are sewn in a continuous horizontal row on the fabric

- lettering size 3 is 15mm
- ❖ touch Alphabet Size button: the field with number «3» is blue
- size 3 monograms are sewn in a continuous horizontal row on the fabric



A

Note:

Size 1 monograms are dealt with differently than sizes 2 and 3. See pages 104-106 (size 1) 107-108 (size 2 and 3).

Sewing Sideways Motion Stitches

- ❖ use slide-on table to enlarge sewing area
- ❖ when sewing, ensure that fabric feeds smoothly and easily, without bumping into anything or dragging
- ❖ it is important to let the sewing computer do the stitching freely; do not pull, push, or hold the fabric back



Balance

- depending on type of fabric, stabilizer and thread quality, the stitched patterns may differ slightly from the original
- use the Balance function to match the selected stitch to the fabric used

TIP

Test sewing

It is always a good idea to test sew with the materials you intend to use – fabric, stabilizer, and threads.

Size 1 Monograms

Stitch: **Size 1 monograms**
 Needle: **size and type suitable for the fabric selected**
 Thread: **cotton, decorative**
 Feed dog: **up (sewing position)**
 Presser foot: **Sideways motion foot No. 40C**



Size 1 Monograms

- size 1 monograms are individual letters, which means that the sewing computer secures and stops
- ❖ templates are used to position monograms
- ❖ monograms can be positioned and combined manually, using templates, or connected automatically with the 16 sewing directions

A



Templates as Sewing Help

- the templates included with the owner's manual are helpful when positioning patterns on the fabric
- all size 1 monograms are printed in their original size on the templates
- the starting point of the individual pattern is marked with a green circle, the end with a red cross. The beginning and end are also provided with a hole (for accurate transfer and marking on the fabric)
- the sewing direction is shown with the presser foot symbol and thin guiding lines
- the presser foot must always run parallel to the guiding lines when sewing

Combining Monogram Letters Manually With Templates

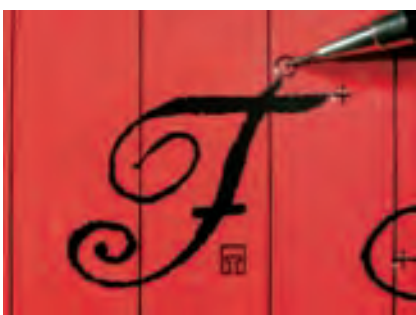

Combining Monogram Letters With Templates

- ❖ using the template, position letter at desired place on fabric
- ❖ transfer starting point (circle) of letter to fabric



Sewing

- ❖ select letter in Single Mode
- ❖ place sideways motion presser foot on the fabric as shown on the template so that needle will go through starting point on letter
- ❖ stitch letter



Adding Letter Using the Template

- ❖ use template to add letter on fabric.
- Again: mark starting point, select letter, place presser foot as shown on template, and stitch letter



Connecting Monogram Combinations Automatically With 16 Directional Sewing

Instead of combining monogram letters manually, they can be combined automatically using the template and the 16 Directional Sewing function.

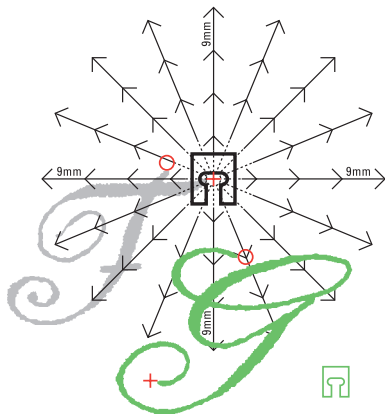

Determining Spacings Using Templates

- ❖ place template with first letter of monogram (e. g. «F») on fabric
- ❖ mark start and end point of letter
- ❖ using the 16 directional sewing template, place second letter of monogram (same sewing direction as first pattern (letter)
 - the foot icon, pointing in the sewing direction, is placed on the end point of the first pattern
- ❖ the start point of the second letter (e. g. «G») must be placed on one of the 16 directions and a spacing mark (arrow point)
- ❖ read the direction to the start point of the next sideways motion stitches (letter), and count the number of spaces (9mm each)

A



Programming Monograms and Spaces

- ❖ select desired letter in Combi Mode (e. g. «F»)
- ❖ select 16 Directional Sewing in Decorative Stitches Category
- ❖ select Straight stitch No. 39 with stitch length basic setting 1 (sews only every 3rd stitch, and is 3mm)
- ❖ enter desired direction
- ❖ activate Long Stitch function (sews only every 9th stitch)
 - one Straight stitch No. 39 (stitch length 1) in combination with the Long Stitch function leads to a spacing of 9mm length
- ❖ program the number of required straight stitches (connecting stitches) according to the counted spacings
- ❖ **Do not forget to delete the Long Stitch function!**
- ❖ select second letter (e. g. «G»)
- ❖ to sew a single repeat activate «Pattern Repeat 1-9x» (number «1» appears)



Sewing Monograms

- ❖ place sideways motion presser foot on the fabric as shown on the template so that needle will go through starting point on letter
- sewing computer will first stitch first letter («F»), sews automatically the connecting stitches, and stops automatically at end of second letter («G»)
- since the monogrammed letters are secured automatically, the connecting stitches can be cut away after completing the stitching



A

Correcting Combinations



Inserting Stitches

- a stitch is always inserted above the cursor
- to insert a stitch at the beginning of a stitch combination, move the cursor up, using the scrolling arrow
- ❖ activate desired place by selecting the required stitch in the Stitch Altering Area or scroll to it
- ❖ select new stitch
- ❖ the stitch will be inserted above the cursor



Deleting Stitches

- stitches are always deleted above the cursor
- ❖ activate desired place by selecting required stitch in the Stitch Altering Area or scroll to it
- ❖ touch «Delete»
- stitch is deleted



• For more information on Preview of Combination see page 160 ●●●●●●

• «Saving Combinations» see page 158 ●●●●●●



Automatic Thread Cutter

Since threads are secured automatically when sewing sideways motion stitches, it is particularly convenient after stitching to cut off threads directly using the Automatic Thread Cutter function.

Size 2 and 3 Monograms

- Stitch: **Size 2 and 3 monograms**
- Needle: **size and type suitable for the fabric selected**
- Thread: **cotton, decorative**
- Feed dog: **up (sewing position)**
- Presser foot: **Sideways motion foot No. 40C**



Size 2 and 3 Monograms

- size 2 and 3 monograms are sewn in a continuous horizontal line
- size 2 and 3 monograms are dealt with similarly to 9mm lettering



A

Size 2 and 3 Monograms in Combi Mode



Combining Size 2 and 3 Monograms

- ❖ open Combi Mode
- ❖ select desired letter
 - letter appears in Stitch Altering Area
 - cursor is behind the letter



- ❖ select next letter, and touch corresponding button
- second letter appears in Stitch Altering Area, etc.



- for more information on Preview of Combination see page 160



Combining Size 2 and 3 Monograms and Functions

Combining Lettering and Functions – An Example

- ❖ open Combi Mode
- ❖ touch letter «B»
 - letter «B» appears in Stitch Altering Area
- ❖ select size 2 monograms
- ❖ touch letter «E»
- ❖ select size 3 monograms
- ❖ select the letters **R, N, I, N, A** in that order
 - the Stitch Altering Area now displays the word «BERNINA»

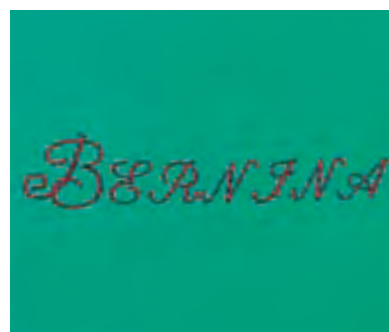

A



Pattern Combination in Single or Multiple Repeat

- ❖ touch Pattern Repeat 1–9x button one or more times (numbers 1–9 appear) after creating a combination
- the sewing computer stops automatically on completion of the entered number of combinations

Correcting Combinations



Inserting Stitches

- a stitch is always inserted above the cursor
- to insert a stitch at the beginning of a stitch combination, move the cursor up, using the scrolling arrow
- ❖ activate desired place by selecting the required stitch in the Stitch Altering Area or scroll to it
- ❖ select new stitch
- the stitch will be inserted above the cursor



Deleting Stitches

- stitches are always deleted above the cursor
- ❖ activate desired place by selecting required stitch in the Stitch Altering Area or scroll to it
- ❖ touch «Delete»
- stitch is deleted

• «Saving Combinations» see page 158



• for more information on Preview of Combination see page 160

Buttonhole Summary **110**

Buttonhole Functions **111**

Important Information **112**

Corded Buttonholes **114**

Automatic Buttonhole **116**

- all types with Direct Entry Length
- Standard and stretch with length calculated from button

Buttonhole in Long Term Memory **118**

Automatic Buttonholes (Standard and Stretch) **119**

- without stitch counter buttonhole

Automatic Round, Keyhole and Hand-look Buttonholes **121**

- without stitch counter buttonhole

Stitch Counter Buttonhole **123**

Manual 4 or 6 Step Buttonhole **125**

- all types of buttonholes
- Round and keyhole buttonhole

Straight Stitch Buttonhole **127**

Bound Buttonhole **129**

Decorative Buttonholes **131**

Button Sew-on Program **132**

Eyelets **133**

Buttonholes

Stitch Summary



Summary

Application of Buttonholes



Standard Buttonhole

Light- to mediumweight fabrics. Blouses, dresses, bedding, etc.



Narrow buttonhole (heirloom sewing)

Light- to mediumweight fabrics. Blouses, dresses, children's and baby clothes, dolls' clothes, crafts



Stretch buttonhole

All stretch fabrics made from cotton, wool, silk and synthetic fibers



Round buttonhole with normal bartack

For medium- to heavyweight fabrics of all types. Clothing, jackets, coats, rainwear



Round buttonhole with horizontal bartack

For medium- to heavyweight fabrics of all types. Clothing, jackets, coats, rainwear



Keyhole buttonhole with normal bartack

Heavyweight non-stretch fabrics. Jackets, coats, leisure wear



Keyhole buttonhole with pointed bartack

Heavyweight non-stretch fabrics. Jackets, coats, leisure wear



Keyhole buttonhole with horizontal bartack

For firm non-stretch fabrics. Jackets, coats, leisure wear



Hand-look buttonhole

Light- to mediumweight woven fabrics. Blouses, dresses, leisure wear, bedding



Straight stitch buttonhole

For reinforcing buttonholes, pocket edges, especially for stitching buttonholes in leather or imitation suede



Button sew-on program

For buttons with 2 and 4 holes



Narrow zig-zag eyelet

Opening for cords and narrow ribbons/bands, decorative work



Straight stitch eyelet

Opening for cords and narrow ribbons/bands, decorative work

In General

Buttonholes are practical closures which can also be used for a decorative effect. The **artista 730** provides a very versatile selection. All buttonholes can be sewn and programmed in a variety of ways.

Buttonholes/Button Sew-on Program/Eyelets



- ❖ press Buttonhole button
- a summary of the different buttonholes and eyelets appears on the screen display



Select Buttonhole/Buttonhole Sew-on Program/Eyelet

- ❖ touch desired stitch
- the selected buttonhole, eyelet or button sew-on program is activated
- if one of the stitches (51-63) is activated, all functions that can be used are on the function toolbar

- for more information on Application see pages 116-133

Buttonhole Program Functions

The functions below appear on the function toolbar at the lower edge of the screen display when any buttonhole (51-59 + 63) is selected.



Programming Buttonhole Length

- the symbol is automatically highlighted in blue (active) when a buttonhole is selected
- using the Quick Reverse button on head frame a buttonhole length can be determined directly



- when the buttonhole is programmed the symbol is turned off (inactive, yellow)
- if a new length is to be programmed the symbol has to be reselected



Buttonhole Length – Direct Entry Length (in mm) or On-screen Button Measurement

- ❖ touch symbol to open special screen display
- ❖ enter the buttonhole length (stitch length in mm) directly with the stitch length or stitch width knob
- ❖ to measure hold button to bottom lower left corner of screen
- ❖ the buttonhole length is obtained by adjusting blue circle to button size (with stitch length or stitch width knob)
- 2mm for the button thickness will be added automatically (with on-screen button measurement only)

Application:

- simple method to determine buttonhole size by direct entry of the length in mm or by measuring button on the screen



Manual Buttonhole

- ❖ touch symbol to open special screen display
- ❖ sew manual buttonhole in 4 or 6 steps (according to buttonhole type)

Application:

- for individual manually sewn buttonholes
- to repair existing buttonholes



Stitch Counter Buttonhole

- ❖ select buttonhole
- ❖ touch symbol
- the stitch counter buttonhole is activated
- ❖ when the desired length is reached (first buttonhole bead), press the external Quick Reverse button
- after length of second bead is determined by pressing the Quick Reverse button, the screen display changes to «auto Stitch Counter»
- the selected buttonhole is programmed

Important Buttonhole Information

Marking Buttonholes

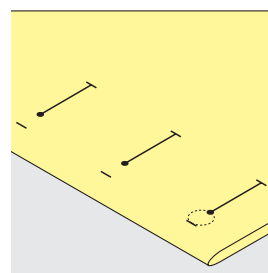
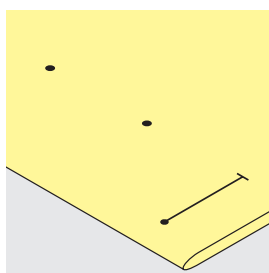
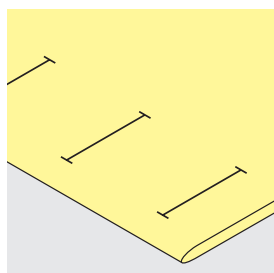

Manual Buttonholes

- Buttonhole foot No. 3C
- ❖ the buttonhole length of manually stitched buttonholes must be marked on the fabric in the appropriate position

Automatic Buttonholes

- Automatic buttonhole foot No. 3A
- ❖ mark the length of the first buttonhole
- after sewing the first buttonhole, the length for all subsequent buttonholes is automatically programmed
- ❖ mark the starting point of all subsequent buttonholes
- the buttonhole length indicates the buttonhole opening in mm

Keyhole Buttonholes

- mark the bead length only
- the correct length eye will be added when the buttonhole is sewn

Correct Interfacing/Stabilizers for Buttonholes



Automatic Buttonholes

- ❖ always use an interfacing (1) so that the buttonholes turn out well
 - the interfacing should suit the fabric type
- ❖ for thick and fluffy fabrics an embroidery stabilizer can be used (2). The fabric feeds better.

Sewing Buttonholes

Test Sewing

- ❖ always sew a test on the fabric(s) you will use with the same interlining and stabilizers
- ❖ select the same buttonhole type
- ❖ sew all buttonholes in the same direction on the fabric (with or against the grain)



Corrections

- to adjust the bead width, alter the stitch width
- to adjust the density of the beads, alter the stitch length
- any alterations to the stitch length with automatic and manual buttonholes affect both beads (making them more or less dense)

Thread Tension

- the tension is set automatically when a buttonhole is selected
- the upper tension is slightly looser than normal
- this gives a slightly rounded appearance to the beads, making the buttonhole more attractive

Balance for Buttonholes



Balance for Direct Entry Length Standard Buttonhole

- any Balance alterations affect both beads

Note:

With Direct Entry Length and Manual buttonholes each individual buttonhole sequence can be balanced separately.

With the Stitch Counter buttonholes any Balance alteration affects both beads differently (left and right): by adjusting the beads the keyhole or eye will be altered as well.

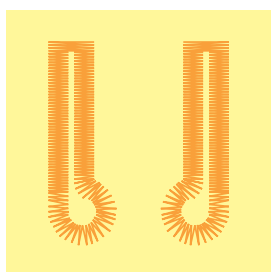

Balance for Direct Entry Length Keyhole or Round Buttonholes

- any Balance alterations affect both beads
- the keyhole or eye is balanced as follows:
 - ❖ 1. sew straight stitches until the sewing computer changes to the keyhole or eye, then stop the sewing computer
 - ❖ 2. touch «Balance» and now adjust the picture in the right portion of the Balance screen with the stitch length knob to suit the sewn buttonhole
 - if keyhole is distorted to the right (picture A)
 - ❖ turn stitch length knob counter clockwise
 - if keyhole is distorted to the left (picture B)
 - ❖ turn stitch length knob clockwise
- ❖ 3. touch «OK» and complete buttonhole



A



B

Balance for Stitch Counter Buttonhole

- any Balance alterations affect both beads differently:
 - if left bead is too dense (picture A)
 - ❖ turn stitch length knob counter clockwise - left bead will be longer, right bead will be shorter
 - if left bead not dense enough (picture B)
 - ❖ turn stitch length knob clockwise - left bead will be shorter, right bead will be longer
- ❖ reprogram buttonhole after each Balance alteration
- ❖ after any Balance changes are made, reprogram the buttonhole

Balance for Manual Standard Buttonhole

- any Balance alterations affect both beads

Balance for Manual Round or Keyhole Buttonhole

- any Balance alterations affect both beads differently (see picture for stitch counter buttonhole)
- the keyhole or eye is balanced as follows:
 - if keyhole is distorted to the left (picture B)
 - ❖ turn stitch length knob counter clockwise
 - if keyhole is distorted to the right (picture A)
 - ❖ turn stitch length knob clockwise

Recommendation

- ❖ sew a test on the fabric(s) you will use



clr

Clear Balance

- ❖ touch «Reset» in the special Balance screen or press external «clr» button («clr» deletes the programmed buttonhole as well!)

Corded Buttonhole

Cords

- gimp cord reinforces buttonholes and enhances their appearance
- the loop of the cord should be at the end of the buttonhole most subject to wear
- position the work accordingly under the presser foot

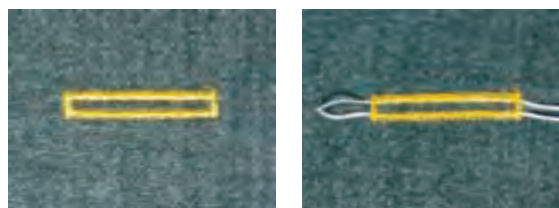

Suitable Cords:

- Perle cotton No. 8
- strong hand-sewing thread
- fine crochet yarn

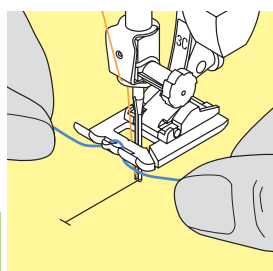

Attaching the Cord Onto Presser Foot No. 3C

- ❖ insert the needle at the beginning of the buttonhole
- ❖ raise the presser foot
- ❖ hook the cord over the center toe of the foot

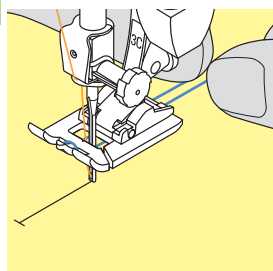

- ❖ place both ends of the cord in the grooves on the sole of the foot and pull them to the back
- ❖ lower the presser foot

Sewing

- ❖ sew the buttonhole in the usual manner, do not hold the cord tightly
- ❖ the buttonhole will form over the cord, covering it

TIP

With presser foot No. 3C also round and keyhole buttonholes can be reinforced with cord.

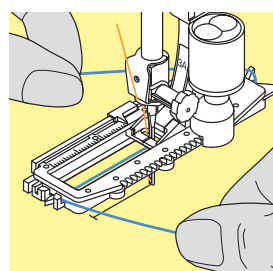

Attaching Cord in Automatic Buttonhole Foot No. 3A

- ❖ insert the needle at the beginning of the buttonhole
- ❖ raise the presser foot
- ❖ guide the cord under the foot to the right
- ❖ hook the cord over the pin at the back of the foot

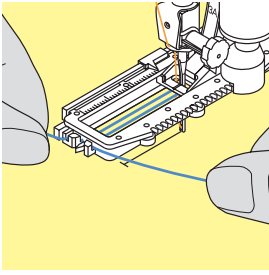

- ❖ bring the cords to the front of the foot
- ❖ pull each end into one of the notches at the front of the foot

Sewing

- ❖ sew the buttonhole in the usual manner
- ❖ do not hold the cord
- ❖ the buttonhole will form over the cord, covering it

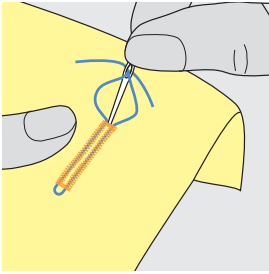

Securing Cord

- ❖ pull the cord through the buttonhole until the loop disappears into the end of it
- ❖ pull the ends of the cord through to wrong side of the fabric, knot or secure with stitches

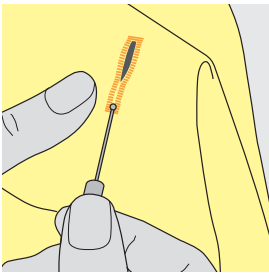

Cutting Buttonholes Open

- ❖ using the seam ripper or buttonhole cutter and block, cut from both ends towards the middle
- ❖ in order not to cut the ends of short buttonholes by mistake, place a pin at the end of the buttonhole for additional security

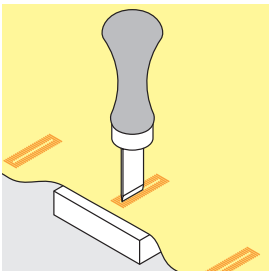

Buttonhole Cutter and Block (optional accessory)

- ❖ place the fabric on a piece of wood
- ❖ place the cutter in the center of the buttonhole
- ❖ press the handle of the cutter (either by hand or with a hammer) to open the buttonhole

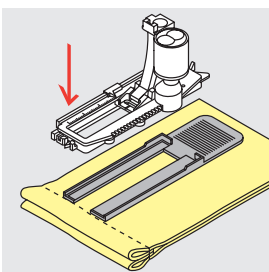

Sewing Buttonhole Diagonal to Edge

Height Compensating Plates for Buttonholes (optional accessory)

- when sewing a buttonhole using Automatic buttonhole foot No. 3A on an uneven area (such as over a seam allowance), use the height compensating plates for buttonholes
- ❖ place the plates from the back between fabric and slide foot bottom up to the thick part of the fabric and push to front
- this accessory will create a smooth surface for the foot and help make a perfect buttonhole

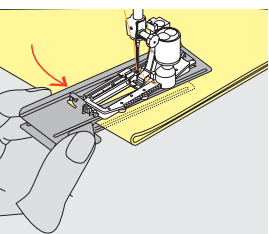

Using the compensation plate (in some countries only available as optional accessory) is recommended when sewing buttonholes in difficult fabrics. It can only be used with the Automatic buttonhole foot No. 3A.



Automatic Buttonhole (All Types) Direct Entry Length



- enter the buttonhole length (buttonhole opening in mm) directly with the stitch length or stitch width knob
- suitable for all buttonhole lengths of 4mm up to the maximum length



Entering Buttonhole Length

- buttonholes can be sewn to a specific length with the Automatic buttonhole foot No. 3A
- ❖ select type of buttonhole
- ❖ touch the Direct Entry Length function

Applications



Determining Buttonhole Length

- a special screen display appears
- ❖ enter buttonhole length with the stitch width or stitch length knob
- the programmed length is shown between the two arrows



- ❖ confirm the desired length with «OK», the screen changes automatically
- «auto» and the programmed length in mm appear on the screen
- the buttonhole length indicates the buttonhole opening in mm

Corrections

- ❖ enter new length as described above

Back to Buttonhole Menu

- ❖ touch «ESC» to return to Buttonhole screen



Deleting Saved Buttonholes

- ❖ press external «clr» button or touch «recording»
- «auto» disappears and «recording» appears
- a new buttonhole length can be programmed

Automatic Buttonhole (Standard and Stretch) Button Measuring on Screen



The buttonhole size can be determined by holding a button on the screen. The length will be determined by the stitch width or stitch length knob.



Opening Button Measurement

- ❖ select buttonhole
- ❖ touch the «Direct Entry Length» function



Determining Button Size

- a special screen appears
- ❖ hold the button against the bottom left corner of the screen
- ❖ use the external stitch width or stitch length knob to adjust the colored circle to fit around the button
- the button size is shown in mm between the two arrows (e.g. 16mm)
- confirm the correct size with «OK», the screen changes automatically

Back to Buttonhole Menu

- ❖ touch «ESC» to confirm and return to Buttonhole screen, the original settings remain

Buttonhole Size

- the sewing computer calculates the buttonhole size from the button diameter
- 2mm are added automatically to take the thickness of the button into account

Corrections for Thick Buttons

- ❖ for buttons which are particularly thick, e.g. raised buttons, etc. make the colored circle 1 – 4mm larger than the button held on the screen

Test Buttonhole

- ❖ sew a test buttonhole on a scrap of the fabric and interfacing
- ❖ cut buttonhole open
- ❖ push button through hole
- ❖ correct the size if necessary



Deleting Saved Buttonholes

- ❖ press external «clr» button or touch «recording»
- «auto» disappears and «recording» appears
- a new buttonhole length can be programmed



Buttonhole in Long Term Memory



Long term saving of buttonhole programs is only possible for buttonholes originally stitched as «auto» length buttonholes.

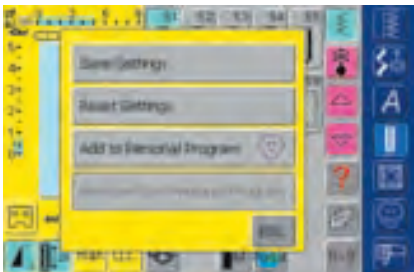

Saving Buttonhole (Save)

- ❖ touch the displayed buttonhole in the Stitch Altering Area (left portion of screen)
- an additional message appears
- ❖ touch the Save function and the buttonhole is saved in the long term Memory

• for more information on programming the desired Automatic Buttonhole see pages 116-117



Recalling Saved Buttonhole

- ❖ select the desired buttonhole type
- the buttonhole length appears on the Direct Entry Length on-screen button
- ❖ touch the Direct Entry Length function and confirm the saved length on the screen that appears with «OK»
- «auto» and the length in mm appear on the screen

Changing Saved Buttonhole

- ❖ select the desired buttonhole type
- ❖ touch the Direct Entry Length function
- change the length of the saved buttonhole on the screen that appears and confirm with «OK»
- ❖ save buttonhole as described above
- programming a new length overrides the existing saved one

Deleting Saved Buttonhole

- ❖ select the desired buttonhole type
- ❖ touch the Direct Entry Length function and program a new length or touch the displayed buttonhole in the Stitch Altering Area
- an additional message appears
- ❖ touch «Reset» and the saved buttonhole is deleted
- a new buttonhole length can be programmed

Automatic Buttonholes (Standard and Stretch)

Without Stitch Counter Buttonhole



- Stitch: **Standard and Stretch buttonholes No. 51, 52 and 53**
- Needle: **size and type suitable for the fabric selected**
- Thread: **cotton or polyester**
- Feed dog: **up (sewing position)**
- Presser foot: **Automatic buttonhole foot No. 3A**



Automatic Buttonhole

- the lens on the Automatic buttonhole foot No. 3A automatically registers the length of the buttonhole (for exact duplication) and automatically completes the buttonhole, when reaching the maximum length
- suitable for all buttonhole lengths of 4mm up to the maximum length, which can be set with stitch width or stitch length knob

Note:

Both beads are sewn in the same direction. The buttonhole length indicates the buttonhole opening in mm.



Sewing Standard and Stretch Buttonholes



Sewing First Bead

- the stitching sequence is displayed in the Stitch Altering Area
- ❖ sew the first bead forwards, stopping at the required length



Programming Buttonhole

- ❖ press the Quick Reverse button on head frame
- «auto» and the programmed length (in mm) appear on the screen to indicate that the buttonhole length is programmed

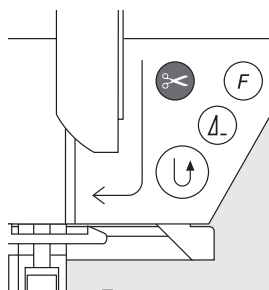

Auto Buttonhole

the sewing computer sews the following automatically:

- straight stitches in reverse
- the first bartack
- the second bead forwards
- the second bartack
- the securing stitches. The sewing computer stops and automatically changes to the beginning of the buttonhole

All subsequent buttonholes will be sewn automatically to the same length (without pressing the Quick Reverse button)



Important: How to Correct Mistakes

- ❖ touch the Pattern Begin function
- the sewing computer reverts to the beginning of the buttonhole



clr

Deleting Saved Buttonholes

- ❖ press external «clr» button or touch «recording»
- «auto» disappears and «recording» appears
- a new buttonhole length can be programmed



TIP

Exact duplicates

The «auto» function ensures that each buttonhole will be exactly the same length as the previous one.

Marking

Due to the «auto» function only the beginning of the buttonholes have to be marked – a real time saver.

TIP

Beautiful buttonholes

Keep the speed consistent for each buttonhole (reduce speed with Motor Speed function if necessary). This results in equal density of the buttonhole beads.

Automatic Round, Keyhole and Hand-look Buttonholes

Without Stitch Counter Buttonhole



- Stitch: **Round and Hand-look buttonholes No. 54 + 55 + 63 and Keyhole buttonholes No. 56–58 size and type suitable for the fabric selected**
- Needle: **size and type suitable for the fabric selected**
- Thread: **cotton or polyester**
- Feed dog: **up (sewing position)**
- Presser foot: **Automatic buttonhole foot No. 3A**



Automatic Buttonhole

- the lens on the Automatic buttonhole foot No. 3A automatically registers the length of the buttonhole (for exact duplication) and automatically completes the buttonhole, when reaching the maximum length

Note:

Both beads are sewn in the same direction. The buttonhole length indicates the buttonhole opening in mm.



Sewing Round and Keyhole Buttonholes

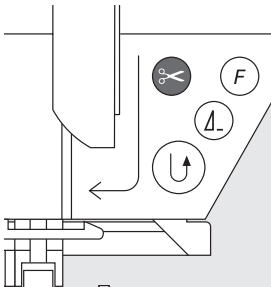

Sewing Straight Stitches

- the stitching sequence is displayed in the Stitch Altering Area
- sew straight stitches forwards, stopping at the desired length



Programming Buttonhole

- press the Quick Reverse button on head frame
- «auto» and the programmed length (in mm) appear on the screen to indicate that the buttonhole length is programmed



Auto Buttonhole

the sewing computer sews the following automatically:

- the eye or the keyhole
- the first bead in reverse
- straight stitches forwards
- the second bead in reverse
- the bartack
- the securing stitches. The sewing computer stops and changes automatically to the beginning of the buttonhole

All subsequent buttonholes will be sewn automatically to the same length (without pressing the Quick Reverse button)



Important: How to Correct Mistakes

- touch the Pattern Begin function
- the sewing computer reverts to the beginning of the buttonhole

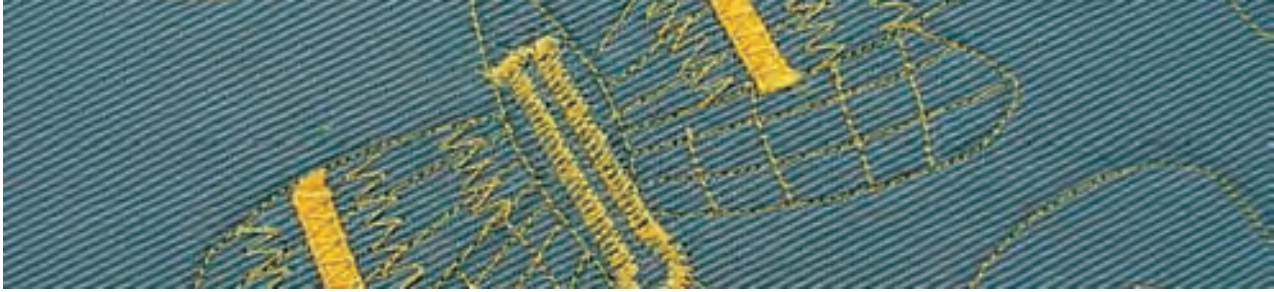

Sewing Hand-look Buttonhole No. 63



Length of the First Bead

- ❖ sew bead to desired length
- ❖ stop sewing computer



Programming the Buttonhole

- ❖ press Quick Reverse button on head frame
- «auto» and the programmed length (in mm) appear on the screen to indicate that the buttonhole length is programmed

Auto Buttonhole

the sewing computer sews the following automatically:



- the eye
 - the second bead in reverse
 - the bartack, the securing stitches and stops automatically
- All subsequent buttonholes will be sewn automatically to the same length (without pressing the Quick Reverse button)



Deleting Saved Buttonholes

- ❖ press external «clr» button or touch «recording»
- «auto» disappears and «recording» appears
- a new buttonhole length can be programmed



TIP

Double sewn keyhole buttonholes

- keyhole buttonholes can be sewn twice on thick fabrics and the stitches are made longer when sewing the first time (without keyhole and pointed bartack)
- ❖ after sewing the first buttonhole, do not move the work, simply tap the foot control once to begin sewing again

TIP

Beautiful buttonholes

- ❖ for successful sewing of buttonholes always use a suitable stabilizer or interfacing
- using a gimp cord enhances the appearance of the buttonholes

Stitch Counter Buttonholes for All Buttonhole Types

Stitch: **Buttonholes (all types)**
 Needle: **size and type suitable for the fabric selected**
 Thread: **cotton or polyester**
 Feed dog: **up (sewing position)**
 Presser foot: **Buttonhole foot No. 3C or Automatic buttonhole foot No. 3A**

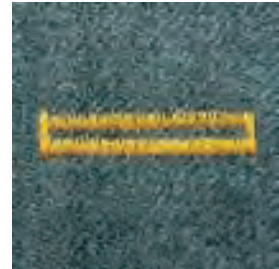

Stitch Counter Buttonholes

- ❖ select buttonhole
- ❖  touch the Stitch Counter function, the sewing computer recognizes the Stitch Counter buttonhole program
- the length of the buttonhole is now determined by the Stitch Counter

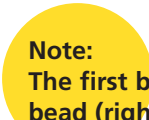

Note:
 The first bead (left) is sewn forwards, the second bead (right) is sewn in reverse.
 The stitch counter buttonhole cannot be saved in the long term Memory.

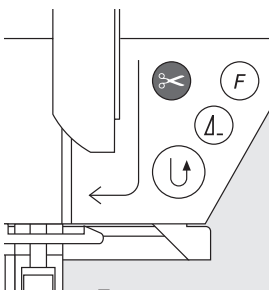

Sewing Stitch Counter Buttonhole

- ❖ sew with consistent speed



Length of First Bead

- ❖ sew the first bead the desired length
- ❖ stop the sewing computer



- ❖ press Quick Reverse button on head frame

Bartack, Second Bead in Reverse



- ❖ bottom bartack and second bead are sewn in reverse
- ❖ stop sewing computer at the first stitch
- ❖ press Quick Reverse button on head frame

Bartack, Securing Stitches



- the sewing computer sews the top bartack, securing stitches and stops automatically
- «auto» and «Stitch Counter» appear on the screen
- the buttonhole is saved
- each subsequent buttonhole will be sewn identically



clr

Deleting Saved Buttonholes

- ❖ press external «clr» button or touch «recording»
- «auto» disappears and «recording» appears
- a new buttonhole length can be programmed



Corrections

- ❖ reprogram the buttonhole if any alterations to the stitch width, length or Balance have been made

Note:

Programmed buttonhole on a different fabric:

- different fabrics and interfacings can affect the look of a stitch counter buttonhole
- if you are using a different fabric, program the buttonhole again
- it is recommended to sew a test on the fabric(s) you will use



TIP

More buttonholes with presser foot No. 3C

Ideal for buttonholes where the Automatic buttonhole foot No. 3A cannot be used.

TIP

Beautiful buttonholes

- always keep the speed consistent for beads of equal density
- sew at a moderate speed for best results (reduce speed with Motor Speed function if necessary)

TIP

Marking

Due to the «auto» function only the beginning of the buttonholes have to be marked – a real time saver.

Manual 4 or 6 Step Buttonholes

(All Types)

Stitch: **any Buttonhole**
Needle: **size and type suitable for the fabric selected**
Thread: **cotton or polyester**
Feed dog: **up (sewing position)**
Presser foot: **Buttonhole foot No. 3C**

Note:

Sewing buttonholes manually is ideal if you only need to sew one; also for repairing existing buttonholes. The number of steps depends on the type of buttonhole.



A manually sewn buttonhole cannot be saved.

man

Opening Manual Buttonhole

- ❖ select the type of buttonhole desired
- ❖ touch «man» for the Manual Buttonhole function



Step Symbols

- the step sequence of the selected buttonhole is shown on the screen
- «1» is activated
- standard buttonhole has 6 steps
- round, keyhole and hand-look buttonholes have 4 steps
- the active step is shown in the center

TIP

Repairing buttonholes

- omit or bypass the unneeded steps
- use only the steps which are necessary to repair the worn sections

Sewing 4 or 6 Step Buttonholes

Round and Keyhole Buttonholes



Note:
The graphic on the screen is the same for the round and keyhole buttonholes.

Sewing a 4 Step Buttonhole

- «1» is activated
- ❖ sew the first bead
- ❖ stop the sewing computer at the desired length
- ❖ touch «2» on the screen
- the sewing computer sews the eye or the keyhole
- ❖ touch «3»
- the sewing computer sews the second bead in reverse
- ❖ stop the sewing computer at the first stitch
- ❖ touch «4»
- the sewing computer sews the top bartack and secures stitches automatically
- the length of the beads is determined manually when sewing
- bartack, eye and securing stitches are preprogrammed

Leave Program

- ❖ touch «ESC»
- screen reverts to the original Buttonhole screen

Sewing a 6 Step Buttonhole



- «1» is activated
- ❖ sew first bead
- ❖ stop sewing computer at the desired bead length
- ❖ touch «2»
- the sewing computer sews straight stitches in reverse
- ❖ stop sewing computer at the first stitch of the first bead
- ❖ touch «3»
- the sewing computer sews the top bartack and stops automatically
- ❖ touch «4»
- the sewing computer sews the second bead
- ❖ stop sewing computer
- ❖ touch «5»
- the sewing computer sews the bottom bead and stops automatically
- ❖ touch «6»
- the sewing computer secures the stitches and stops automatically
- ❖ the bead length is determined by the user
- the bartack and the securing stitches are preprogrammed

Note :
6 bartack stitches are sewn and the sewing computer stops automatically.
If more than 6 bartack stitches are to be sewn, simply tap the foot control once to begin sewing again.

Straight Stitch Buttonhole



- Stitch: **Straight stitch buttonhole No. 59**
Needle: **size and type suitable for the fabric selected**
Thread: **cotton or polyester**
Feed dog: **up (sewing position)**
Presser foot: **Buttonhole foot No. 3C or Automatic buttonhole foot No. 3A**



Automatic Program With Automatic Buttonhole Foot No. 3A

The lens on the Automatic buttonhole foot No. 3A automatically registers the length of the buttonhole (so it can be duplicated exactly).

Note:

Straight stitched buttonholes are particularly useful for reinforcing buttonholes on all soft and loosely woven fabrics such as wool, or for buttonholes which are subject to extreme wear. They are also useful for reinforcing buttonhole openings in leather, vinyl or felt.



Straight Stitch

- ❖ select stitch No. 59 on the screen



Altering the Distance

- ❖ alter the stitch width if the distance between the rows of stitching is too wide or too narrow

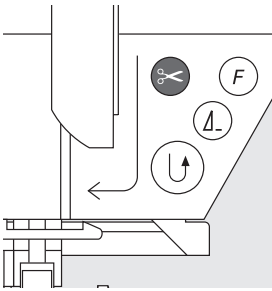

Sewing Straight Stitch Buttonhole

Sewing the Automatic Buttonhole Program

- ❖ sew the first row of straight stitches forwards until the desired length is reached
- ❖ press the Quick Reverse button
 - «auto» and the programmed length (in mm) appear which means the length is programmed
 - the sewing computer completes the buttonhole program automatically
 - all subsequent buttonholes will be stitched to the same length (without pressing the Quick Reverse button)
 - the distance between the stitched rows can be adjusted with the stitch width



Sewing With Foot No. 3C (Stitch Counter)

- ❖ select the Stitch Counter function for stitch counter buttonholes
- Buttonhole foot No. 3C will register the number of stitches in the buttonhole

Sewing Stitch Counter Straight Stitch Buttonhole

- ❖ sew the first bead, stop stitching at the desired length
- ❖ press the Quick Reverse button on head frame
- ❖ sew the end of the buttonhole and then the second bead in reverse
- ❖ stop sewing computer at the first stitch
- ❖ press the Quick Reverse button on head frame
 - the sewing computer sews the horizontal bar and securing stitches and stops automatically
 - «auto» and the programmed length (in mm) appear on the screen
 - each subsequent stitched buttonhole will be sewn to the same length as the programmed buttonhole

TIP

Straight stitched buttonholes are also useful for reinforcing buttonhole openings in leather, synthetic leather, vinyl or felt.

Bound Buttonhole



- Stitch: **Straight stitch buttonhole No. 59**
Needle: **80 – 100 H**
Thread: **cotton or polyester**
Feed dog: **up (sewing position)**
Presser foot: **Buttonhole foot No. 3C or Automatic buttonhole foot No. 3A**
For topstitching: Straight stitch foot with sliding sole No. 53 (optional accessory)

Suitable Material for Bound Buttonholes

- synthetic leather
- leather
- Alcantara
- plastic coated fabrics

Sewing Bound Buttonhole

1. Determining Buttonhole Size

- ❖ cut a rectangular piece of fabric 1 1/4" (3cm) longer and 1 1/2" (4cm) wider than the buttonhole. This will create the welts.
- ❖ place it on the leather (right sides together) and allow for facing if necessary
- ❖ sew Straight stitch buttonhole No. 59 (stitch width being 9mm)

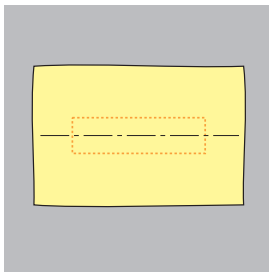

2. Cutting Buttonhole Open

- ❖ cut buttonhole open in the center with pointed scissors about 5mm away from the end
- ❖ at the corners cut diagonally to the seam – make sure not to cut into the seam!

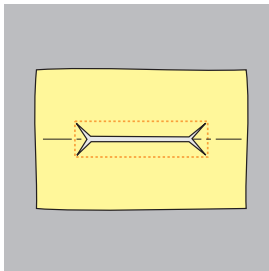

3. Turning Buttonhole Through

- ❖ turn the buttonhole through to the wrong side
- ❖ press edges outwards

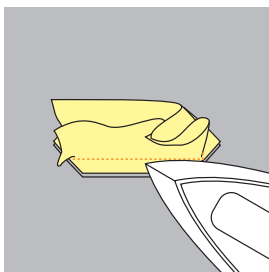

TIP

Press synthetic leather or leather carefully on medium heat and with a cloth.

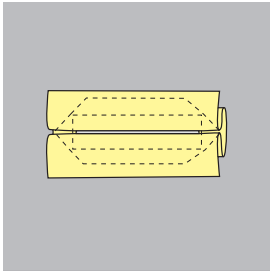
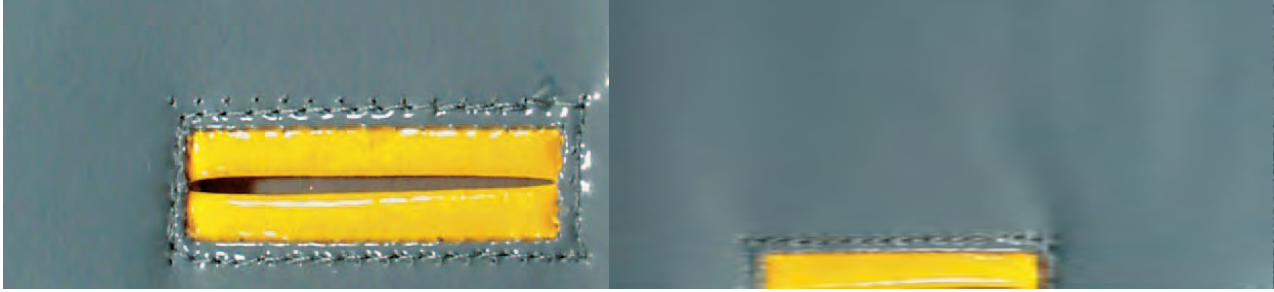

4. Pressing Welts

- ❖ press welts on the wrong side of the fabric or baste, so that two equally big strips are formed on the right side

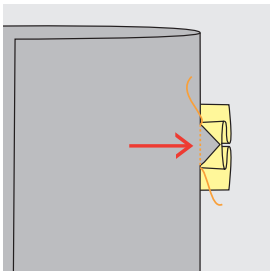

5. Edgestitching

- ❖ edgestitch the buttonhole (see picture)
- ❖ place facing on the wrong side

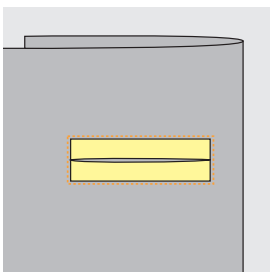

6. Topstitching Buttonhole

- ❖ topstitch buttonhole with the Straight stitch foot with sliding sole No. 53 on the right side (including facing)

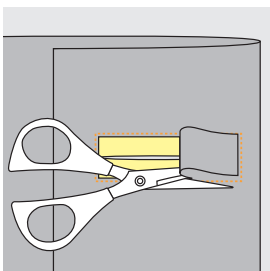

7. Trimming Leather

- ❖ cut leather of facing on the wrong side inside the sewn rectangle and trim away slightly

TIP

Bound buttonhole in other materials

- ❖ sew buttonhole as described under 1. – 7.
- ❖ at the end, finish edges by hand and secure

Decorative Buttonholes

- Stitch: **Buttonholes (all types)**
Needle: **size and type suitable for the fabric selected**
Thread: **cotton, polyester or embroidery threads**
Feed dog: **up (sewing position)**
Presser foot: **Reverse pattern foot No. 1C (for topstitching)
Buttonhole foot No. 3A or No. 3C**

Decorative Buttonholes

- suitable for all buttonholes
- for decorating buttonholes as a creative element

Sewing



Topstitched Lizard

- ❖ copy sketched lizard onto fabric or draw with a fine pencil, tailor's chalk or an air or water soluble marker (test first on fabric remnant)
- ❖ topstitch lizard along the drawn outlines and create the inner part with a zig-zag stitch (see picture)
- ❖ sew buttonhole either with foot No. 3A or 3C



Buttonhole With Decorative Stitches

- ❖ sew buttonhole either with Buttonhole foot No. 3A or 3C
- ❖ embellish buttonhole with Decorative stitch No. 107 and placket with Decorative stitch No. 708

TIP

Buttonhole with embroidery

Create buttonhole and combine with your personal embroidery from the artista PC software.



Button Sew-on Program



Stitch: **Button sew-on program No. 60**
Stitch width: **depends on the distance between the holes**
Needle: **size and type suitable for the fabric selected**
Thread: **cotton or polyester**
Feed dog: **down (darning position)**
Presser foot: **Button sew-on foot No. 18**



Note:

Buttons with 2 and 4 holes can be attached with presser foot No. 18. The shank (thread length between button and fabric) can be made shorter or longer as desired. Buttons sewn on for decorative purposes only are stitched without a thread shank.



Button Sew-on Program

- ❖ select stitch No. 60 on the screen

Sewing 2 Hole Button

- ❖ check distance between holes with the handwheel and adjust stitch width if necessary
- ❖ hold the threads when starting to sew
- ❖ sew on button
 - the sewing computer stops automatically when program is completed and is immediately ready for the next button

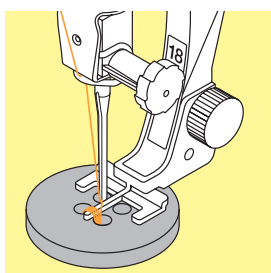

Sewing 4 Hole Button

- ❖ sew the front holes first
- ❖ carefully move the button forward
- ❖ sew the back holes with the same program

Beginning and Ending Threads

- ❖ the threads are secured and can be trimmed

For Secure Results

- ❖ pull both bobbin threads until the ends of the upper thread are visible on the wrong side (knot if required)
- ❖ trim threads

TIPS

Sewing on buttons

A real time saver, especially when several of the same type buttons must be sewn on, e.g. blouses, bedding, etc.

For work which is subject to heavy wear or washing, sew Button sew-on program twice.

Zig-zag or Straight Stitch Eyelets



- Stitch: **Narrow zig-zag eyelet No. 61 or Straight stitch eyelet No. 62**
Needle: **size and type suitable for the fabric selected**
Thread: **cotton or polyester**
Feed dog: **up (sewing position)**
Presser foot: **Reverse pattern foot No. 1C**

Note:

Eyelets are ideal openings for cords and narrow ribbons, attractive decorative elements, ideal for children's clothing, and crafts. They cannot be programmed in stitch combinations.



Eyelet Programs

- ❖ select desired eyelet
No. 61 = zig-zag eyelet
No. 62 = straight stitch eyelet

Sewing Eyelets

- ❖ position fabric under the presser foot and sew
- the sewing computer stops automatically when finished and is immediately ready for the next eyelet
- sew twice for a more filled in satin stitch eyelet

Punching Eyelets

- ❖ use an awl or punch to cut open the eyelet



TIP

Decorative eyelets

Ideal for eyes on soft toys, dolls or use decorative thread to introduce an attractive element.



Stitch Summary **136**

Important Information on
Different Techniques **137**

Quilters Securing Program **138**
• Stitch No. 324

Quilting Straight Stitch **139**
• Stitch No. 325

Piecing Stitch/Straight Stitch **140**
• Straight stitch No. 326

Hand-look Quilt Stitch **141**
• Stitches No. 328, 346–350

Decorative Quilt Stitches **142**
• Stitches No. 327, 332–345, 351

Satin Stitch **143**
• Stitch No. 354

Blanket Stitches **145**
• Stitches No. 329, 330, 352, 353

Turned-edge Appliqués **146**
• Blindstitch No. 331

Freehand Quilting **148**
• Stitch No. 325

Freehand Quilting With BSR **149**
(Bernina Stitch Regulator)
Straight Stitch No. 1 or
Zig-Zag Stitch No. 2

Quilt Stitches

Quilt Stitches



Summary

Quilt Stitches

Different stitches can be selected which can be used especially for quilting, patchwork or for appliqué:

- No. 324 Quilters securing program
- No. 325 Quilting straight stitch
- No. 326 Piecing stitch / Straight stitch
- No. 327 Stippling stitch
- No. 328 Hand-look quilt stitch
- No. 329 Blanket stitch
- No. 330 Double blanket stitch
- No. 331 Blindstitch
- No. 332 Feather stitch
- No. 333 - 338 Feather stitch variations
- No. 339 - 345, 351 Decorative quilt stitches
- No. 346 - 350 Quilt stitch / Hand-look quilt stitch variations
- No. 352 Blanket stitch (dual)
- No. 353 Double blanket stitch (dual)
- No. 354 Satin stitch

- ❖ touch the stitch of your choice
 - the stitch is activated
 - all information on-screen is visible
 - stitch widths/stitch lengths can be altered and customized



Important Information on Different Techniques

Patchwork, Appliqué and Quilting

Patchwork

- with this technique fabric of different colors, forms and patterns are sewn together to make blankets, wall hangings and garments
- for the design of patchwork basic geometric forms are most suitable, e.g. different rectangular and triangular forms as well as squares

Stitch for patchwork:

- No. 326 Piecing stitch / Straight stitch



Appliqué

- to appliqué is to apply patches of fabric by sewing or embroidering on the base fabric
- apart from creative and artistic designing the appliqué technique also makes it possible to cover damaged areas in a clever way

Following stitches can be used:

- No. 354 Satin stitch
- No. 329, 330, 352, 353 Blanket stitches
- No. 331 Blindstitch



Quilting

Quilts consist of three layers:

- decorative top layer of fabric (usually patchwork)
- middle layer - batting
- bottom layer in plain fabric used as lining

After these three layers, which result in a «quilt sandwich», have been pinned and basted they are sewn together with different stitches. This is called quilting.

Following stitches are suitable for quilting:

- Nr. 324 Quilters securing program
- Nr. 325 Quilting straight stitch
- Nr. 328, 346–350 Hand-look quilt stitches
- Nr. 327, 331–345, 351 Decorative quilt stitches
- freehand quilting with or without BSR (optional accessory)



Quilters Securing Program



- Stitch: **Quilters securing program No. 324**
Needle: **size and type suitable for the fabric selected**
Thread: **cotton, decorative or monofilament**
Feed dog: **up (sewing position)**
Presser foot: **Reverse pattern foot No. 1C or
Walking foot No. 50 (optional accessory)**

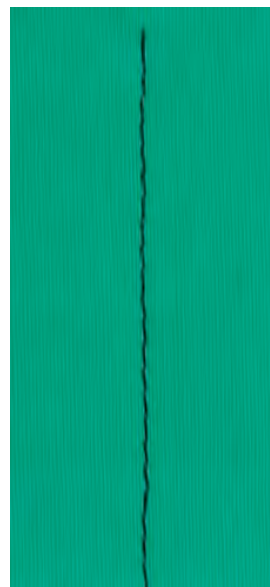

Applications

Quilters Securing Program

- suitable for all fabrics and quilting
- secures beginning and end of seam

Preparation

- ❖ prepare a «quilt sandwich» by placing the batting between the lining and the top layer
- ❖ pin and base the «quilt sandwich»

Beginning the Seam

- the sewing computer automatically secures at the beginning (six small stitches forwards)
- ❖ continue sewing until shortly before the end

Ending the Seam

- ❖ press and release the Quick Reverse button on head frame. The sewing computer secures automatically (six small stitches forwards) and stops automatically.



Note:

For work which is subject to heavy wear or washing, use Securing stitch No. 5.



TIP

Perfect stitch formation

When using thick fabric lengthen the stitch length.

TIP

Needle stop down

A great help when quilting.

Quilting Straight Stitch

- Stitch: **Quilting straight stitch No. 325**
Needle: **size and type suitable for the fabric selected**
Thread: **cotton, decorative or monofilament**
Feed dog: **up (sewing position)**
Presser foot: **Reverse pattern foot No. 1C or Walking foot No. 50 (optional accessory)**

Quilting Straight Stitch

- this quilt stitch is a straight stitch with a longer basic setting for machine quilting
- suitable for all fabrics and quilting

Preparation

- ❖ prepare a «quilt sandwich» by placing the batting between the lining and the top layer
- ❖ pin and base the «quilt sandwich»

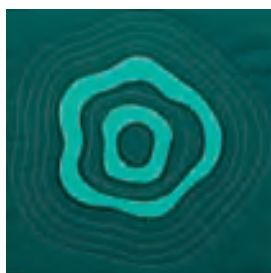
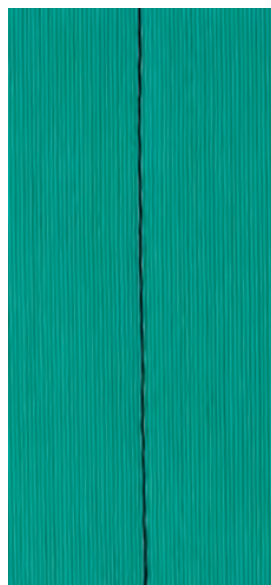

Outline Quilting (Echo Quilting)

- allows you to add decorative elements
- ❖ echo quilt in regular distances from the patchwork seams or around the form of the applied motif



Pattern Quilting

- allows you to add decorative elements
- ❖ allows you to sew as many lines and forms on the work as desired



Shadow Quilting

- suitable for work where no additional effect is desired apart from the effect of the fabric strips sewn together
- ❖ sew with the quilt stitch directly on the seam lines of the work

TIPS

Perfect stitch formation

When using thick fabric lengthen the stitch length.

Invisible quilt effect

If a monofilament thread is used the quilted seam looks invisible.

Needle stop down

A great help when quilting.



Piecing Stitch / Straight Stitch



Stitch: **Piecing stitch / Straight stitch No. 326**
Needle: **size and type suitable for the fabric selected**
Thread: **cotton**
Feed dog: **up (sewing position)**
Presser foot: **Reverse pattern foot No. 1C,
Patchwork foot No. 37 or Patchwork foot with
guide No. 57 (optional accessory)**

Piecing Stitch / Straight Stitch

- this piecing stitch is a short straight stitch
- suitable for piecing all patchwork

Sewing

- ❖ pin fabric strips and sew them together

1,2,3...

Sewing With Stitch Counter Function

For patchwork which consists of several strips of the same size, it helps to use the Stitch Counter function as well.

- ❖ touch symbol, the Stitch Counter function is activated
- ❖ sew until the desired length is reached
- ❖ press external Quick Reverse button
- the number of sewn stitches is programmed (temporarily)
- further fabric patches can be sewn together with the same programmed length (the sewing computer automatically stops at the end)

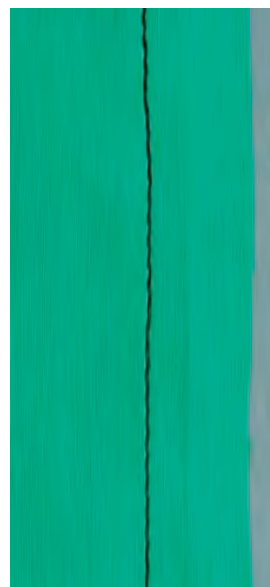



Hand-look Quilt Stitch

Stitch: **Hand-look quilt stitches No. 328, 346–350**
Needle: **size and type suitable for the fabric selected**
Needle thread: **monofilament**
Bobbin thread: **50 or 30 weight cotton**
Feed dog: **up (sewing position)**
Presser foot: **Reverse pattern foot No. 1C or Walking foot No. 50 (optional accessory)**

Hand-look Quilt Stitch

- suitable for all fabrics and work which should look «hand sewn»

Sewing a Test

- the bobbin thread has to be brought up; one stitch is visible (bobbin thread) and one stitch is invisible (monofilament thread), which results in the hand-look effect

Upper Thread Tension

- the upper thread tension is automatically set
- increase upper thread tension to suit fabric if necessary

Balance

- adjust stitch with the Balance if necessary

Sewing

- the hand-look quilt stitch can be sewn in any needle position

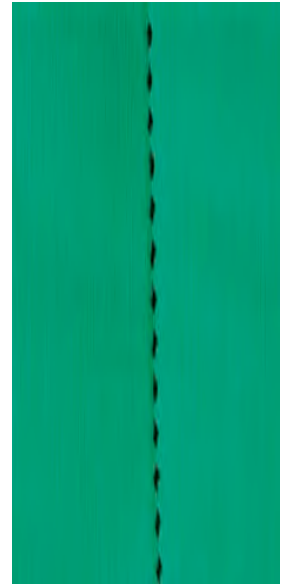

TIP

Perfect corners

- ❖ activate Pattern End and Needle Stop (the sewing computer automatically stops with the needle down) and pivot the work
- ❖ when pivoting make sure that the needle ends in a down position, pivot and begin stitching

TIP

Monofilament thread breaks

If the monofilament thread breaks, sew more slowly and/or reduce the upper thread tension slightly.

Decorative Quilt Stitches

Stitch: **Decorative quilt stitches No. 327, 332–345, 351**
Needle: **size and type suitable for the fabric selected**
Thread: **cotton or decorative**
Feed dog: **up (sewing position)**
Presser foot: **Reverse pattern foot No. 1C or
Open embroidery foot No. 20C**

Decorative Quilt Stitches

- suitable for all fabrics and quilting
- especially applicable for crazy quilting

Preparation

- ❖ prepare a «quilt sandwich» by placing the batting between the lining and the top layer
- ❖ pin and base the «quilt sandwich»

Sewing

- ❖ select quilt stitches and sew
- when applying crazy quilting the decorative quilt stitches are sewn over the patches as required
- all quilt stitches can be combined in the Combi Mode

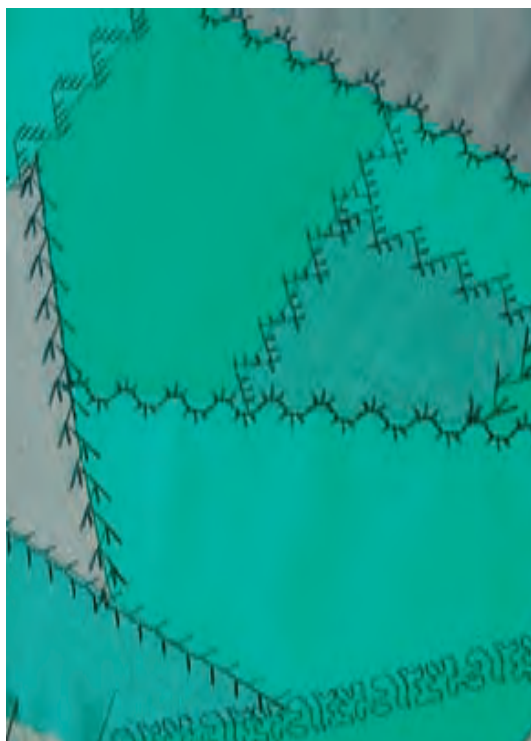

TIP

Perfect stitch formation

- ❖ when using thick fabric lengthen the stitch length
- ❖ adjust stitch with the Balance if necessary

TIP

Perfect corners

Activate Pattern End and Needle Stop (the sewing computer automatically stops with the needle down) and pivot the work.

TIP

Stippling stitch No. 327

The stippling stitch can be enlarged by using the Sideways motion stitch No. 515 or stitch No. 516.

Satin Stitch



Stitch: **Satin Stitch No. 354**
Needle: **size and type suitable for the fabric selected**
Thread: **cotton, polyester, decorative**
Feed dog: **up (sewing position)**
Presser foot: **Appliqué foot No. 23 (optional accessory),
Reverse pattern foot No. 1C or
Open embroidery foot No. 20C**



Satin Stitch

- applying decorative appliqués
- suitable for many fabrics

Note:

Instead of double-sided adhesive stabilizer use fabric spray adhesive.



1



2



3

Preparation of Appliqué

- double-sided adhesive stabilizer helps to fix the motif on the base fabric and prevents it from creasing when sewing
- ❖ design the motif in original size
- ❖ copy a mirror image of the motif onto the paper side of the stabilizer and cut out roughly
- ❖ press the stabilizer onto the wrong side of the appliqué fabric (coated side lies on the fabric, see picture 1)

- ❖ cut exactly along the motif (see picture 2)
- ❖ tear off paper side (see picture 2)

- ❖ place motif on base fabric (see picture 3)
- ❖ if necessary place additional stabilizer under the base fabric (e.g. embroidery stabilizer) to give fabric extra stability

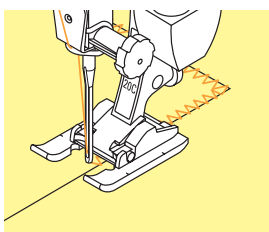

Sewing Appliqué

- ❖ secure the motif by oversewing the edge of the appliqué
- ❖ the stitch goes slightly over the edge of the motif into the base fabric on the right swing of the needle (if required alter the needle position accordingly)





Sewing Rectangular Corners (90°)

- ❖ sew 3-4 stitches over the outer fabric edge
- ❖ stitch over edge of the motif, needle position down and turn sewing
- ❖ continue sewing, the corner will be oversewn twice

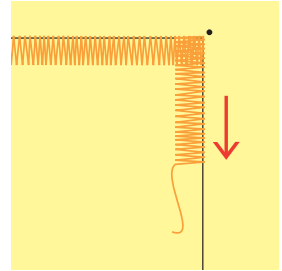

Sewing Obtuse Inside Corners (100°)

- ❖ sew until the needle is down in the middle of the angle inside the motif
- ❖ sew the corner in form of sun rays, i.e. needle down always at the same point on the motif, turn sewing slightly, sew two stitches, etc.

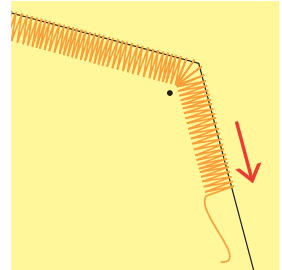

Sewing Mitered Corners

- ❖ sew up to about 3/8" (1cm) before the corner
- ❖ when continuing to sew reduce the stitch width slightly (almost 0)
- ❖ stitch right into the middle of the corner, needle position down (outside the motif) and turn sewing
- ❖ continue sewing and set the stitch width to its original setting in the first 3/8" (1cm)

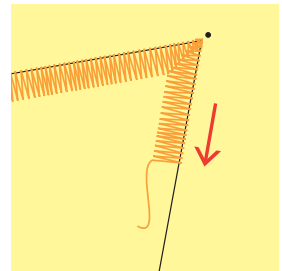

Sewing Curves

- ❖ sew slowly and stop often:
- ❖ inner curves (1): needle position down inside the curve
- ❖ outer curves (2): needle position down outside the curve
- ❖ turn sewing slightly and continue sewing
- ❖ repeat several times so that a nice and regular curve is obtained

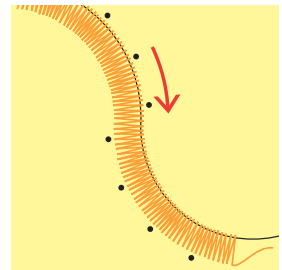

TIP

Securing

Sew a few straight stitches within the satin stitch

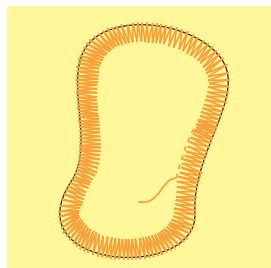

TIPS

Needle stop down

Needle stays in fabric when pivoting and turning.

Sewing speed

Reduced sewing speed allows better precision.

Perfect stitch formation

Different fabric types may make it necessary to alter the stitch length and width.

Blanket Stitches

- Stitch: **Blanket stitches No. 329, 330, 352, 353**
Needle: **size and type suitable for the fabric selected**
Thread: **cotton, decorative**
Feed dog: **up (sewing position)**
Presser foot: **Reverse pattern foot No. 1C or
Open embroidery foot No. 20C**

Blanket Stitches

- stitches No. 329 and No. 352 are for light- to mediumweight fabrics
- stitches No. 330 and No. 353 are for medium- to heavyweight fabrics

Sewing With Blanket Stitch No. 329 or No. 330 (Double Blanket Stitch)

- particularly suitable for appliqué
- ❖ prepare motifs for appliqué and place on fabric
- ❖ sew along the appliqué
- make sure that the vertical parts of the stitch are sewn on the outside edge next to the appliqué on the base fabric and the horizontal parts of the stitch are placed on the appliqué

- For more information on «Sewing Appliqués» see pages 146-147

Sewing With Blanket Stitch No. 352 (dual) or No. 353 (Double Blanket Stitch (dual))

- suitable for appliqué, attaching ribbons and sewing fabric strips, couching decorative threads or yarns
- ❖ prepare work
- ❖ sew exactly on the edge between the appliqués or ribbons
- make sure that the vertical parts of the stitch are sewn directly between the appliqué or strips and the horizontal parts of the stitch are placed on the appliqué or strips to the left and right of both edges

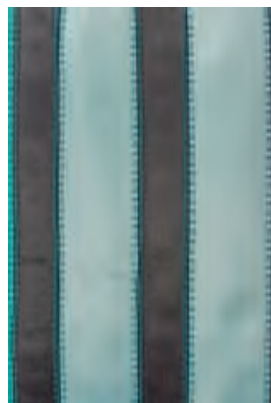
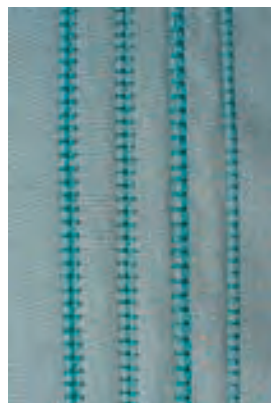

TIP

Hand-stitched effect

- for a hand-stitched effect increase the stitch length and width according to the fabric
- for single blanket stitch, thread a 90 needle with two threads (using two spools and threading as one) for a hand-stitched effect

Turned-edge Appliqués



Stitch: **Blindstitch No. 331**
Needle: **size and type suitable for the fabric selected**
Thread: **monofilament**
Feed dog: **up (sewing position)**
Presser foot: **Reverse pattern foot No. 1C**



Turned-edge Appliqué

- the motifs with turned edges are sewn on the base fabric
- with monofilament thread the seam is hardly visible



Preparation

- ❖ draw a mirror image of the motif on the non adhesive side of a slightly stronger press-on stabilizer
- ❖ cut out stabilizer along the outline with scissors or rotary cutter
- ❖ press the stabilizer onto the wrong side of the appliqué fabric (make sure that the stabilizer sticks well)
- ❖ cut all around the fabric with an allowance of approximately 6mm
- ❖ snip allowance every 5mm (closer together in narrow curves)



- ❖ fold allowance over the stabilizer edge to the wrong side. The form is determined by the pressed on stabilizer. Smooth edges with finger.
- ❖ press and if necessary correct form irregularities

Sewing

- ❖ place motif on base fabric and pin or use spray adhesive
- ❖ sew appliqué with the blindstitch clockwise all around
- ❖ sew that only the tips of the stitch (left points of stitch) are placed in the appliqué motif





Variations

Use Paper Template Instead of Press-on Stabilizer

- ❖ use thicker paper as template instead of press-on stabilizer
- by removing the paper before sewing, the appliqué will be softer (covers, cushions, etc.)
- ❖ draw motif on the thicker paper and prepare the appliqué as described (press the allowance around the paper template)
- ❖ remove paper after pressing
- ❖ pin motif and sew

Freezer Paper



- freezer paper is well known in quilter circles and is used instead of press-on stabilizer
- ❖ work on appliqué as described using spray adhesive on freezer paper to attach it to the appliqué fabric
- ❖ press allowance onto the shiny side
- ❖ sew the motif, however stop shortly before the end and pull out the freezer paper through the opening



Freehand Quilting

- Stitch: **Quilting straight stitch No. 325**
Needle: **size and type suitable for the fabric selected**
Thread: **monofilament, cotton or decorative**
Feed dog: **down (darning position)**
Presser foot: **Darning foot No. 9 or Quilting foot No. 29 (optional accessory)**

Freehand Quilting

- for all freehand quilt work

Preparation

- pin and baste top layer, batting, and lining together
- attach the slide-on table

Holding the Work

- ❖ hold the fabric with both hands like an embroidery frame
- ❖ start quilting in the center and work out towards the edges

Quilting a Design

- ❖ turn the work using smooth, round movements to form the design of your choice (either freehand or following a template)

Stipple Quilting

- this technique covers the entire surface of the fabric
- the lines of stitching are rounded without any sharp corners; they never cross or touch one another

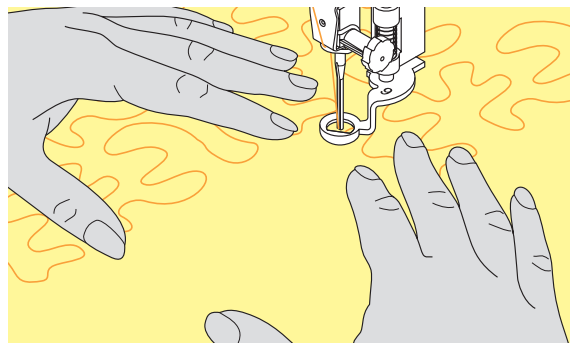

TIP

Freehand quilting and darning

Both techniques are based on the same free-motion principles.

TIP

Monofilament thread breaks

If the monofilament thread breaks, sew more slowly and/or reduce the upper thread tension slightly.

TIP

Poor stitch formation

- if the thread forms loops, the work is being moved too quickly
- if knots are forming on the wrong side, the work is being moved too slowly
- place fabric in a hoop for easier guiding

TIP

Thread breaks

Usually as a result of sudden or jerky movements – move the fabric smoothly and at an even pace.

Freehand Quilting With BSR (BERNINA Stitch Regulator) optional

- Stitch: **Straight stitch No. 1 or Zig-zag stitch No. 2**
 Needle: **size and type suitable for the fabric selected**
 Thread: **monofilament or cotton, embroidery thread, polyester**
 Feed dog: **down (darning position)**
 Presser foot: **BSR foot No. 42 incl. interchangeable soles (closed, open, transparent)**



BSR (BERNINA Stitch Regulator) Function

The BSR presser foot reacts to the movement of the fabric under the foot and controls the speed of the sewing computer up to the maximum speed possible. The following applies: the faster the fabric is moved the higher the

speed of the sewing computer. If the fabric is moved too fast an acoustic signal (beep) is heard. The beeper can be turned on or off on the «BSR» screen.

BSR Function With Straight Stitch No. 1

This function using a special presser foot allows for free-motion quilting (sewing) using the straight stitch and a pre-selected stitch length (up to 5mm).

A regulated set stitch length is maintained within a certain speed, independent of the movement of the fabric.

BSR Function With Zig-zag Stitch No. 2

The zig-zag stitch can be used for thread painting or fabric embellishment for example.

The set stitch length will NOT be maintained when sewing with the zig-zag stitch, but the BSR function simplifies the application.

Warning!

By activating the BSR function the sewing computer sews either continuously at a reduced motor speed (mode 1, standard) or one single stitch (mode 2).

As long as the BSR presser foot is illuminated red, adjustments like threading and changing the needle, for example must not be carried out, as the needle will engage while fabric is moved unintentionally! Without fabric feed the BSR mode is turned off after approx. 7 seconds and the red light goes off.

Please refer to the Safety Instructions!

BSR function can be sewn in 2 separate modes of

BSR operation 1

- BSR mode 1 is the active standard
- the sewing computer runs continuously at a reduced motor speed, as soon as the foot control or the Quick Reverse button is pressed
- moving the fabric under the foot will engage the sewing computer to accelerate
- through the continuous needle movement securing in the same position is possible without pressing an additional button

BSR 2

- touch the button «BSR2» to engage BSR mode 2
- the sewing computer will only engage if the foot control or the Quick Reverse button is pressed and the fabric is moved simultaneously
- the movement of the fabric determines the sewing speed
- for securing, the «Securing Function» button must be pressed
- touch the button «BSR1» to engage BSR mode 1

For an even sewing start (one single stitch) the foot control must be pressed and the fabric moved simultaneously. This also applies for sewing points and straight stitching within a round form.

If the BSR function is deactivated and later re-activated without the sewing computer being switched off in between, the last selected BSR mode is active.



Preparation

Securing Function (only Mode 2)

- lower the feed dog
- the presser foot pressure must be reduced

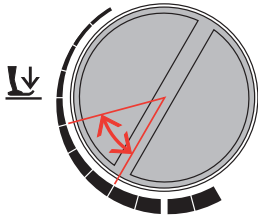

- use slide-on table
- attach the desired presser foot sole to the BSR presser foot
- removing sole: press both buttons (see arrows) on each side of the foot
- slide the sole down the groove at an angle
- attaching the sole: slide the sole up in the groove until it clicks into place

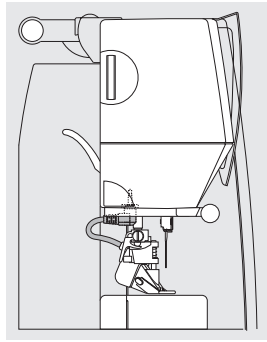

- attach the BSR presser foot to the sewing computer and plug the cable into the green socket until it clicks into place

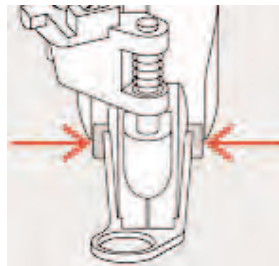

- the «BSR» screen opens automatically
- the BSR mode 1 is activated (BSR1 is standard)
- the basic stitch length setting is 2mm
- set the desired stitch length
- when sewing small forms and stippling, stitch length of 1mm - 1.5mm is suggested

Using the following functions in the BSR mode:

Needle Stop Down (Default)

- the arrow points down on the display = the sewing computer stops with needle down, when taking foot off foot control

- re-start the BSR mode by pressing the Quick Reverse button to continue the stitching process

Needle Stop Up

- press "Needlestop up/down" function. The arrow points up = the sewing/embroidery computer stops with the needle up on releasing the foot control

Raise or Lower the Needle

- by pressing the heel on the foot control, the needle can be lowered or raised

Securing With the Quick Reverse Button (only Mode 1)

- unplug the foot control
- place the fabric under the presser foot, lower presser foot
- hold upper and lower thread tight and press Quick Reverse button to start BSR mode
- sew 5 to 6 securing stitches
- stop the BSR mode by pressing the Quick Reverse button
- cut threads

Securing Function (only Mode 2)

- press the «Securing Function» button
- press the foot control or the Quick Reverse button
- short securing stitch sequence will be sewn as soon as the fabric is moved under the presser foot. After the sequence is sewn the set stitch length will be activated and the securing function will be automatically deactivated



Free Hand Quilting Without BSR Activation

- touch the BSR button (on the left side on the display)
- the BSR mode is deactivated, the buttons «BSR1» and «BSR2» on the left side on the display go off
- normal free hand quilting **can now be sewn with the BSR foot, without automatic regular stitch length**

When exceeding a certain speed, adhering to regular stitch length cannot be guaranteed.

Make sure that the lens on the bottom of the BSR foot is not dirty (fingerprints, etc.). Clean lens periodically with soft, slightly damp cloth.

Beeper (Acoustic Signal) Deactivation/Activation



Beeper Deactivation/Activation

- touch the bar with the speaker symbol for BSR one time
- if the bar is blue, the sound for the beeper is active
- if the bar is gray and the speaker is red, the sound for the beeper is inactive

Activating the BSR Sewing Function:

With the Foot Control

1. With the Foot Control

- plug in the foot control
- lower the presser foot
- start the BSR mode by pressing the foot control
- a red light appears on the presser foot
- the foot control must be pressed continuously during sewing
- the speed of the sewing computer will be regulated by the movement of the fabric
- by releasing the foot control the BSR mode will be stopped

2. With the Quick Reverse Button

- remove the foot control
- lower the presser foot
- start the BSR mode by pressing the Quick Reverse button

- a red light appears on the presser foot
- the speed of the sewing computer will be regulated by the movement of the fabric
- by re-pressing the Quick Reverse button the BSR mode will be stopped

Deactivating the BSR Sewing Function:

Mode 1:

- if the fabric is not moved for approx. 7 seconds, the BSR mode will be deactivated and the red light on the presser foot goes off

Mode 2:

- if the stitching process is ended by no longer moving the fabric, one additional stitch is made depending on the needle position. The sewing computer always stops with the needle up, even if the arrow on the display points down



Holding the Work

- hold and guide the taut fabric with both hands
- abrupt movements of the fabric (slowing down, speeding up respectively) can result in slightly too short or too long stitches
- continuous movement of the fabric (no abrupt movements) under the foot will provide best results
- move the fabric in one direction for best results

Application Example:

BSR With Zig-zag Stitch No. 2

- the zig-zag stitch can be used for thread painting or fabric embellishment for example
- areas can be filled and forms or pictures created



BSR Function Deactivation

- pull out the plug of the BSR presser foot connection cable on the sewing computer. The previously selected stitch is active again
- remove the BSR foot



Programming Screen 154

Selecting Motifs 155

Deleting Motifs 155

Altering Motifs 156

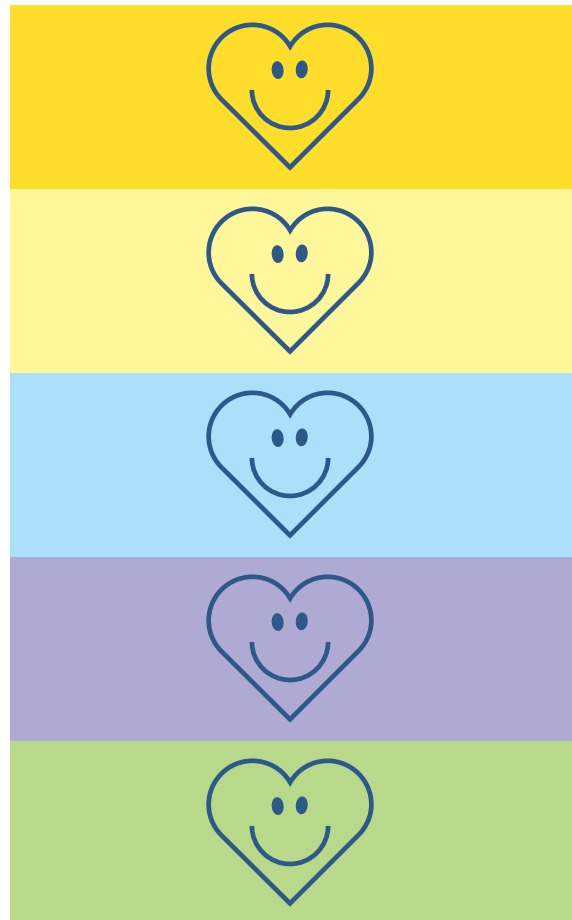

Personal Program

Programming Screen With Personal Stitches

Use the Personal Program to design a screen with the stitches you use most.

Whether it is made up of stitches for a certain type of sewing, such as heirloom or garment, or just your favorite practical and decorative stitches or alphabets, this screen will make it easy and quick to sew any project.

When inserting stitches into the Personal Program, variations of all stitches may be entered into the Personal Program.

Note:

Following alterations may be entered:

- **stitch width**
- **stitch length**
- **Needle Position**
- **Thread Tension**
- **Mirror Image**
- **Pattern Extend**
- **Long Stitch**
- **Balance**
- **Pattern Repeat 1–9**



Programming First Stitch

- ❖ select the zig-zag stitch from the Practical Stitch program (make alterations if necessary)
- ❖ touch the Stitch Altering Area (light blue)

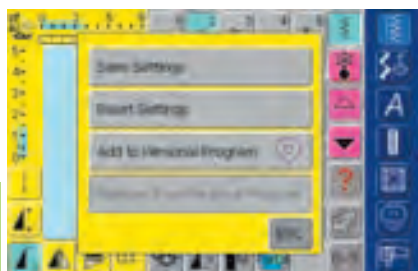

- a special screen appears
- ❖ touch the bar «Add to Personal Program»
- the zig-zag stitch is saved in the Personal Program (including any alterations), the screen closes



Programming Second Stitch

- ❖ press the Buttonhole button
- ❖ select Standard buttonhole (No. 51)
- ❖ touch the Stitch Altering Area (light blue)
- ❖ save the stitch as described above
- ❖ insert further stitches in the same manner

Selecting Stitches in Personal Program



Activating Personal Program

- ❖ press the Personal Program button



Personal Screen

- in the personal screen the programmed stitches are visible (progressive stitch numbers)
- when more than 15 stitches are programmed, use arrow to scroll for viewing additional stitches

Deleting Personal Stitches



Activating Personal Program

- ❖ press the Personal Program button



Personal Program Screen

- ❖ select the stitch to be deleted
- ❖ touch the Stitch Altering Area (light blue)

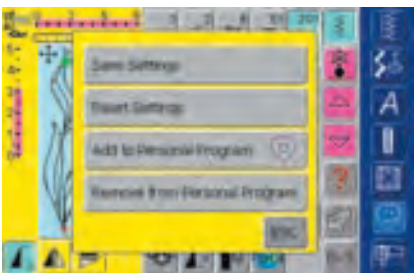

- a special screen appears
- ❖ touch the bar «Remove from Personal Program»



Stitch Deleted

- the special screen closes
- the selected stitch is deleted, all remaining stitches will move along to fill the space



Altering Stitches



Activating Personal Program

- ❖ press the Personal Program button



Personal Program Screen

- ❖ select the stitch to be altered (e.g. zig-zag)
- ❖ alter stitch width and length with the external stitch width and stitch length knobs
 - the alterations as well as the basic settings are indicated
- ❖ touch the Stitch Altering Area (light blue)

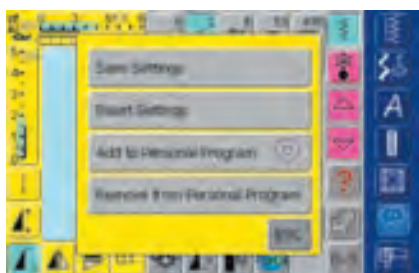

- a special screen appears
- ❖ touch the bar «Save Settings» and all alterations are saved, the special screen closes

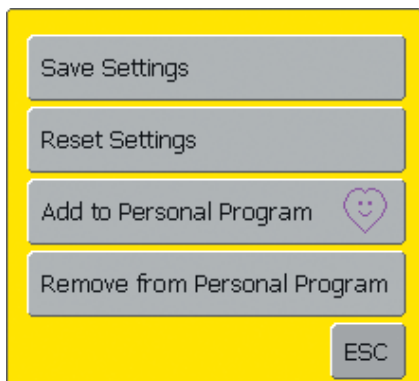

Special Screen

- «Save Settings»: all alterations (stitch length and width, etc.) of the selected stitch are saved
- «Reset Settings»: all alterations of the selected stitch are reset to basic settings
- «Add to Personal Program»: a selected stitch (with possible alterations) is saved in the Personal Program
- «Remove from Personal Program»: a selected stitch is deleted from the Personal Program
- touch «ESC» – the screen closes without anything being saved



TIP

The possible alterations of the original stitch setting can also be altered permanently in each category.

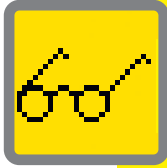

Programming and Saving **158**

- In general
- Stitch combinations
- Opening saved combinations

Corrections and Alterations **161**

- Deleting
- Inserting stitch combinations
- Sub-dividing combinations

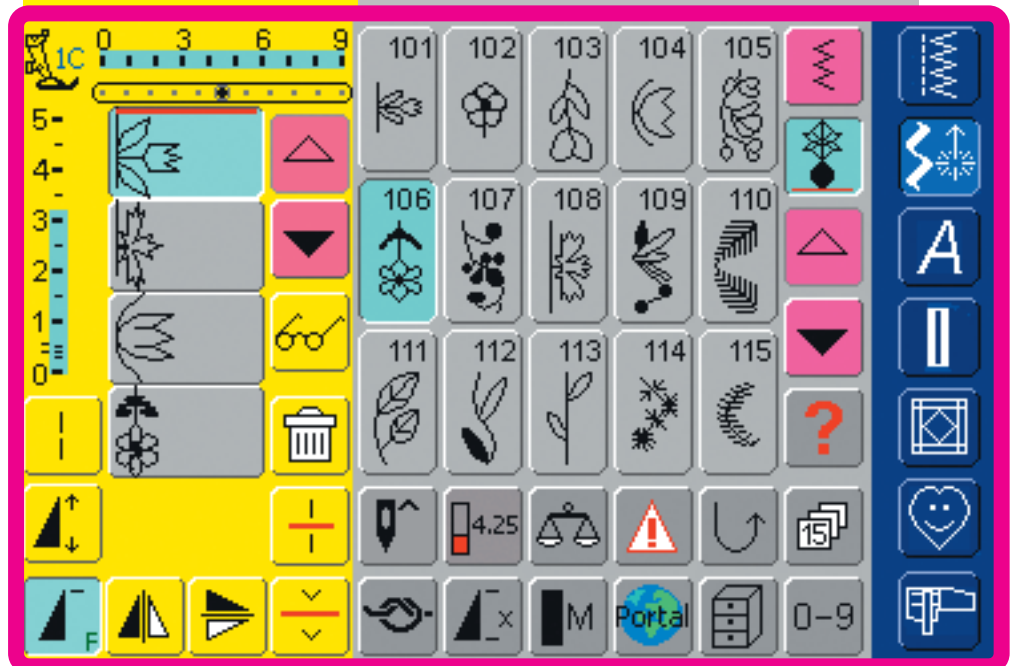

Saving and Deleting Stitches and Stitch Combinations

In General

Stitches, letters, and numbers can be combined and stored in the memory system. The sewing computer has a memory system, in which the two memories – sewing and embroidery – can be stored. The storage space is not sub-divided into fixed spaces, i.e. any number of stitch combinations can be stored in the Drawers as long as there is free storage space (capacity) available.

It may well be, however, that not all Drawers can be filled, due to the saving of many stitches or stitch combinations.

The memory is a long term memory, i.e. the contents remain in it until deliberately deleted. A power cut, or switching off («0») the sewing computer do not affect the saved program.

Programming and Saving

Programming and Saving Stitch Combinations



Programming and Saving Stitches



- ❖ select Combi Mode
 - the Stitch Altering Area appears with its functions
- ❖ select desired stitch
- ❖ alter stitch length, stitch width, needle position or functions such as mirroring, etc. if necessary
- ❖ select further stitches



- ❖ touch the Multifunction button
- ❖ touch «Save Combination» to save the combination

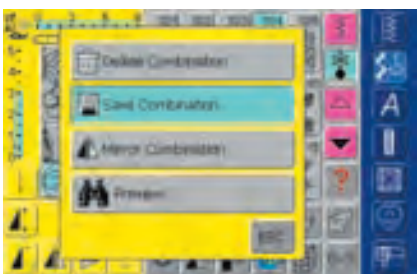

- ❖ select the Drawer where you wish to save the stitch combination
 - the System Memory Capacity (Free Capacity) is shown in percentage (%) in a bar above the Drawers screen

Programming and Saving Stitches by Number



- ❖ select Combi Mode
- ❖ touch «0-9» button
- ❖ enter number of desired stitch
- ❖ touch arrow to delete individual numbers
- ❖ touch field above the numeric pad to delete all numbers
- ❖ touch «Add» to select further stitches by number
- ❖ touch «OK» if selection is complete
- ❖ touch the Multifunction button
- ❖ touch the function «Save Combination»
- ❖ select the Drawer where you wish to save the stitch combination

Empty Stitch Altering Area

- if the Combi Mode has already been in use and the sewing computer has not been switched off («0») since, the last programmed or selected stitch combination appears in the Stitch Altering Area
- ❖ empty the Stitch Altering Area by deleting combination or open an empty Drawer to program a new combination



Emptying the Stitch Altering Area in Steps

- the stitch above the cursor is deleted
- ❖ touch the Delete function until the Stitch Altering Area is empty



Emptying the Stitch Altering Area in a Single Step

- ❖ touch the Multifunction button
- ❖ select «Delete Combination»
- ❖ touch «Yes» to confirm the message
- the Stitch Altering Area is now empty, and a new stitch combination can be programmed



Note:
This procedure does not affect stitch combinations already saved, which remain intact.





Opening Empty Drawer

- ❖ touch the «File Drawers» button
- Drawers screen appears
- ❖ select an empty Drawer
- the System Memory Capacity (Free Capacity) is shown in percentage (%) in a bar above the Drawers screen



- the Stitch Altering Area is now empty, and a new stitch combination can be programmed
- ❖ if desired, save the stitch combination

Drawer Content at a Glance



- ❖ program a stitch combination
- the corresponding stitch combination is visible in the Stitch Altering Area
- ❖ touch the Multifunction button
- ❖ select «Preview»
- the stitch combination is displayed on screen
- each stitch can be selected directly, e.g. to alter it:
 - ❖ select stitch, SAA appears automatically to alter selected stitch
- ❖ use the arrows to scroll through the stitch combinations
- ❖ use the Binocular icon to switch to the Preview screen (sewing view)
- ❖ touch «ESC» to close the Preview screen



Opening Saved Combination



Opening a Saved Combination

- ❖ touch «File Drawers»
- a summary of the saved combinations appears
- ❖ scroll to the desired Drawer if necessary
- ❖ touch the desired Drawer
- the saved combination appears in the Stitch Altering Area



Correcting Stitch Combinations



Deleting the Stitch Last Programmed

- ❖ touch «Delete»
- the stitch last entered is deleted

Note:
All alterations always affect the area above the cursor.



Deleting a Stitch Within the Combination

- ❖ use the scroll arrows to move the cursor below the stitch to be deleted, or select the stitch directly
- ❖ touch «Delete»
- the stitch above the cursor is deleted
- the stitches are automatically recombined

Corrections and Alterations



Inserting Stitches

- ❖ to activate the desired place, scroll the cursor or select appropriate stitch directly
- ❖ select new stitch
- the new stitch is inserted after the selected stitch



- to insert a stitch at the very beginning of a combination, move the cursor right to the top using the scroll arrow
- ❖ select new stitch
- the new stitch is inserted above the cursor



Altering Stitch Combinations

- ❖ to activate the desired place, scroll the cursor or select the appropriate stitch directly
- ❖ select desired function (e.g. mirroring)

Note:
Already saved stitch combinations can be altered or corrected in the same way. To save corrections and alterations permanently, the combination must be resaved afterwards.



Mirroring Entire Combinations

- ❖ touch Multifunction button
- ❖ touch «Mirror Combination»
- the entire combination is mirrored horizontally (left/right)



Sub-dividing Combinations

- a combination can be divided into different parts with the function «Combination Sub-Divider (2)» (e.g. name, street, place, etc.)
- ❖ sew the first part, the sewing computer stops automatically when reaching the Sub-divider function
- ❖ reposition the fabric: press the foot control and the next part is sewn, etc.
- when using the «Combination Sub-Divider (1)», only that particular part of the sub-division is sewn where the cursor is placed allowing you to program many stitches in one file, but use the «Combination Sub-Divider (1)» to treat each segment as its own file



Deleting Drawer

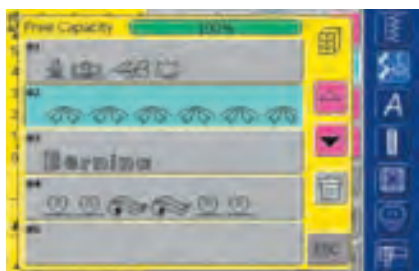

Option 1: Overwriting

- ❖ program new stitch combination
- ❖ touch Multifunction button
- ❖ touch the «Save» button (Drawers screen appears)
- ❖ select the Drawer you wish to overwrite
- ❖ confirm message with «Yes»
- the new stitch combination is now saved in this Drawer

Option 2: Deleting

- ❖ touch the button «File Drawers»
- saved combinations appear
- ❖ touch «Delete»
- a message appears: select the combination you wish to delete
- ❖ touch desired Drawer
- ❖ press "Yes" to confirm the appearing message = the combination will be deleted
- ❖ touch «ESC» to close Drawers screen

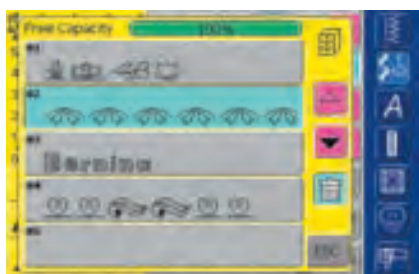

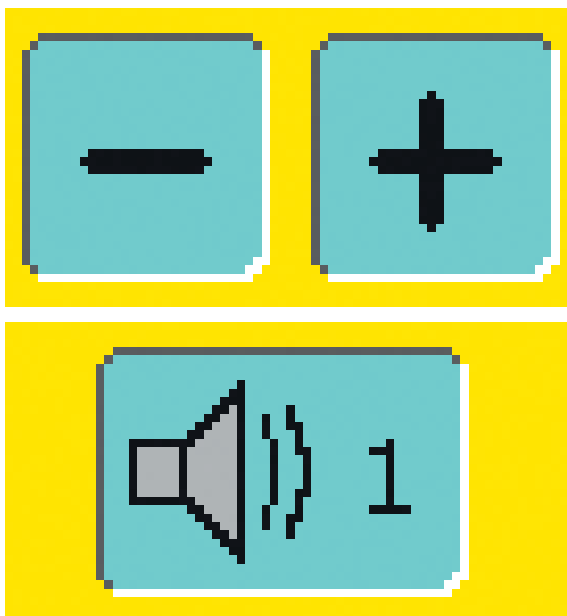

- In General **164**
 - Display **165**
 - Sewing Settings **166**
 - Embroidery Settings **167**
 - Touch (Screen Sensitivity) **169**
- Customize Favorite Function Button **170**
- Information **170**
- Messages and Audio Settings **172**
- Portal Provider Settings **174**
- Hardware **175**
 - Reset to Factory **175**

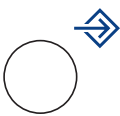
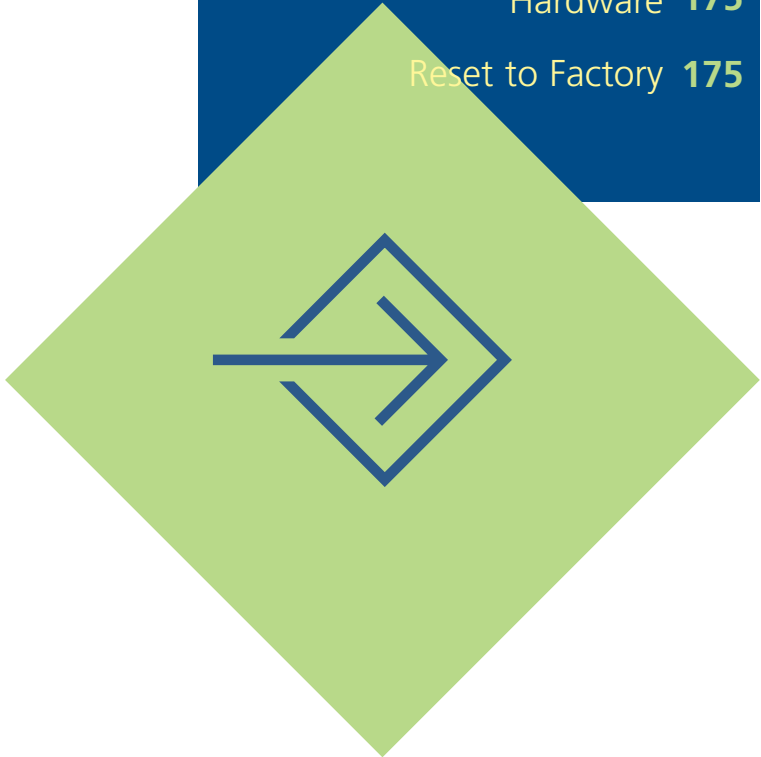

Setup Program

In General

The Setup Program allows you to personalize the touch screen to suit your own requirements and preferences. For example, you can change the setting of the thread tension or reprogram the Favorite Function button on the head frame. After setting the sewing computer to your personal requirements all changes made in the Setup Program will be saved, even when the sewing computer is turned off («0»). The sewing computer can be reset and returned to the factory settings at any time.

Note:

If stock embroidery designs that came with the sewing computer are deleted, use the enclosed USB stick to reload them to the sewing computer.



Opening Setup Program

- ❖ press the external Setup button
- menu with Setup options appears



Menu

- the menu lists all features in the sewing computer which can be altered to suit your requirements:
 - Display (screen)
 - Sewing Settings
 - Embroidery Settings
 - Touch (screen sensitivity)
 - Customize Favorite Function button
 - Information
 - Messages and Audio Settings
 - Portal Provider Settings
 - Hardware
 - Reset to Factory
- the customized alterations remain saved even when the sewing computer is turned off («0»)
- the alterations can be reprogrammed at any time



Leaving Setup Program

- ❖ touch «ESC»
- the Setup Program closes
- returns to previous screen



To Next Page

- ❖ touch «To Next Page»
- the next screen appears



Saving and Closing

- ❖ touch «OK»
- changes are saved, the screen closes and the menu appears



To Previous Page

- ❖ touch «To Previous Page»
- the previous screen appears



Closing Screen

- ❖ touch «ESC»
- the screen display closes, the original settings remain saved and the menu appears

Display

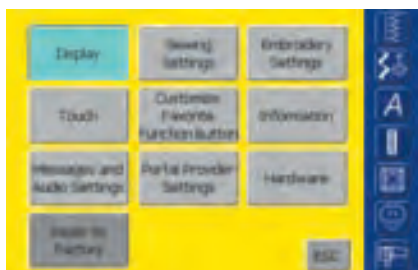

Opening Setup Program

- ❖ press the external Setup button
- menu appears
- ❖ touch «Display»
- the screen «Display Settings» appears

Display Settings



Contrast

- ❖ touch «+» or «-»
- the contrast of the screen changes

Brightness

- ❖ touch «+» or «-»
- the brightness of the screen changes
- the changes are indicated by the number in the bar and the blue background of the «+» and «-»
- the «Default» on-screen button returns you to the basic settings

Welcome Screen

- ❖ touch Text bar
- a screen with a keyboard appears



Text in Welcome Screen

- text for the Welcome screen can be written
- the «ABC» on-screen button (upper case) is automatically active (blue)
- the «abc» on-screen button changes to lower case
- the «ÄÄÄ», «äää» and «@#» on-screen buttons activate special characters in the upper and lower case
- «1,2,3» activates numbers and mathematical characters
- the bar below the keyboard is a space bar and produces spaces between the words or letters
- the programmed text appears in the Text bar above the keyboard
- ❖ by touching this Text bar the programmed text will be completely deleted
- ❖ by touching the arrow on the right of the Text bar, entered text is deleted from right to left



Saving and Closing

- ❖ touch «OK»
- changes are saved, the screen closes and the menu appears



Closing Screen

- ❖ touch «ESC»
- the screen display closes, the original settings remain saved and the menu appears



Sewing Settings



Opening Setup Program

- ❖ press the external Setup button
 - menu appears
- ❖ touch «Sewing Settings»
 - the screen «Sewing Settings 1» appears

Sewing Settings 1



Sewing Light

- when the bar is active (blue) the sewing light will be on continuously when the sewing computer is turned on
- when the bar is inactive (x) the sewing light will not come on when the sewing computer is turned on

Motor Speed

- ❖ touching «+» or «-» changes the maximum speed (4/4). It increases or reduces the speed by 10 stitches
- the number in the bar reflects the stitches per minute
- any change of the maximum speed affects all 4 speeds (1/4 – 4/4), i.e. slower or faster at all four levels
- the «Default» on-screen button returns you to the basic settings

Thread Tension Correction

- ❖ touching «+» or «-» changes the basic setting (0) of the upper Thread Tension by plus or minus 20%
 - 0 = basic settings (factory settings)
 - 1 = + 10%
 - 2 = + 20%
 - 1 = - 10%
 - 2 = - 20%
- this correction fine tunes the basic tension setting on your sewing computer, which may be affected by variables such as thread weight, etc.
- the number in the bar and the blue background of the «+» and «-» reflect the changes
- the «Default» on-screen button returns you to the basic settings
- the tension alteration affects all stitches and remains saved when the sewing computer is turned off («0»)



Embroidery Settings

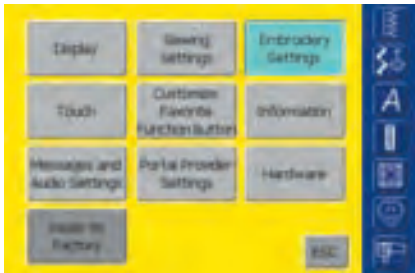

Opening Setup Program

- ❖ press the external Setup button
- menu appears
- ❖ touch «Embroidery Settings»
- the screen «Embroidery Settings 1» appears for adjusting the embroidery hoop

Embroidery Settings 1

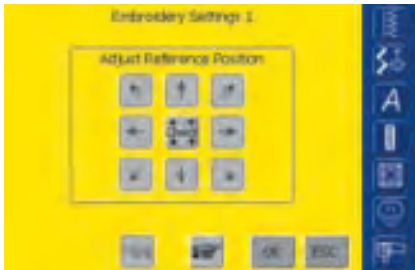

«Adjust Reference Position» calibrates the needle to the center of the embroidery hoop. Adjusting can only be activated if the embroidery module and the oval embroidery hoop are attached. It is only necessary to adjust the Reference Position once as the same setting changes will apply to all the hoops.

- ❖ insert the embroidery template into the hoop
- ❖ touch «Check»
- the hoop position is read and the needle positioned in the middle (the hoop position should now be positioned exactly over the center point of the template)
- ❖ if it is not, adjust with the arrows
- ❖ touch «OK»
- the adjustment will be saved, the screen display closes and the menu appears

Embroidery Settings 2

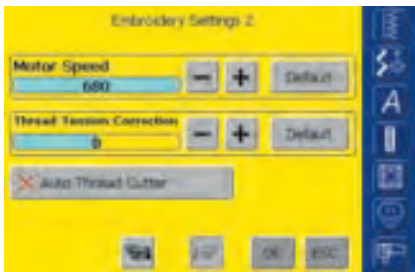

- ❖ touch «To Next Page»
- the screen «Embroidery Settings 2» appears

Motor Speed

- touching «+» or «-» changes the basic settings of the speed by 10 stitches
- the number in the bar reflects the stitches per minute
- any change of the speed affects all 4 speeds (1/4 – 4/4), i.e. slower or faster at all four levels

Auto Thread Cutter

- when the bar is active (blue) the upper thread and bobbin thread are automatically cut
- when the bar is inactive (x) the Automatic Thread Cutter is off
- ❖ touching the bar «Auto Thread Cutter» activates or deactivates the function

Thread Tension Correction

- ❖ touching «+» or «-» changes the basic setting (0) of the upper Thread Tension by plus or minus 20%
 - 0 = basic settings (factory settings)
 - 1 = + 10%
 - 2 = + 20%
 - 1 = - 10%
 - 2 = - 20%
- this correction fine tunes the basic tension setting on your sewing computer, which may be affected by variables such as thread weight, etc.
- the number in the bar and the blue background of the «+» and «-» reflect the changes
- the «Default» on-screen button returns you to the basic settings
- the tension alteration affects all motifs and remains saved when the embroidery computer is turned off («0»)





To Next Page

- ❖ touch «To Next Page»
- the next screen appears



To Previous Page

- ❖ touch «To Previous Page»
- the previous screen appears



Saving and Closing

- ❖ touch «OK»
- changes are saved, the screen closes and the menu appears



Closing Screen

- ❖ touch «ESC»
- the screen display closes, the original settings remain saved and the menu appears



Touch (Screen Sensibility)



Opening Setup Program

- ❖ press the external Setup button
- menu appears
- ❖ touch «Touch»
- the screen «Touch Setup» appears



Touch Setup

- ❖ touch «+» or «-»
- the touch sensitivity changes
- the changes are indicated by the number in the bar and the blue background of the «+» and «-»
- the «Default» on-screen button returns you to the basic settings
- ❖ after having changed the sensitivity touch the «Calibrate» bar
- a further screen display appears

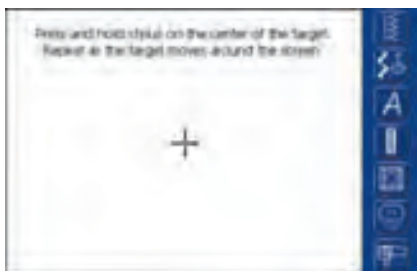

Touch 2

- to activate the new data follow the instructions on the screen
- an additional screen display appears

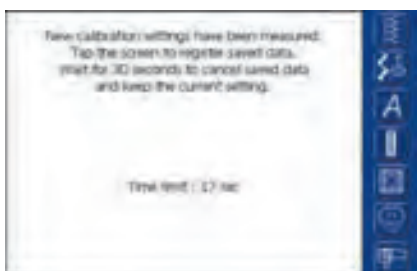

Touch 3

- to save the new data follow the instructions on the screen
- the screen «Touch Setup» appears again



Saving and Closing

- ❖ touch «OK»
- changes are saved, the screen closes and the menu appears



Closing Screen

- ❖ touch «ESC»
- the screen display closes, the original settings remain saved and the menu appears



Customize Favorite Function Button

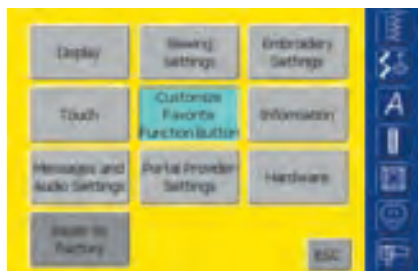

Opening Setup Program

- ❖ press the external Setup button
 - menu appears
- ❖ touch «Customize Favorite Function Button»
 - the screen «Customize Favorite Function Button» appears



Customize Favorite Function Button

- the basic setting on the Favorite Function button is «Pattern Begin», which is visible as active function in the «F» bar
- ❖ from the on-screen function button summary another desired function can be selected, e.g. «Motor Speed»



- the selected function is immediately visible as active function in the «F» bar
- the programmed function is shown with an «F» in the display



Saving and Closing

- ❖ touch «OK»
 - changes are saved, the screen closes and the menu appears



Closing Screen

- ❖ touch «ESC»
 - the screen display closes, the original settings remain saved and the menu appears

Information

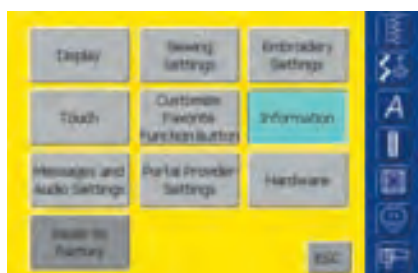

Opening Setup Program

- ❖ press the external Setup button
 - menu appears
- ❖ touch «Information»
 - the screen «Software and Language» appears with information on software version and active language

Software Version

- the current version of the sewing computer and the embroidery module (has to be attached to the sewing computer) can be seen

Language

- the active language is displayed

- ❖ touch «To Next Page»



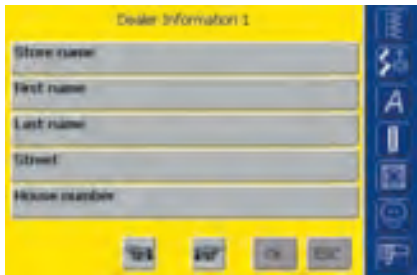

- the screen «Dealer Information 1» appears
- ❖ Press the respective gray fields to enter the following dealer-related data:
 - Store name
 - First name
 - Last name
 - Street
 - House number
- ❖ touch «To Next Page»

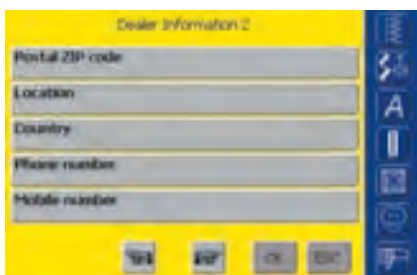

- the screen «Dealer Information 2» appears
- ❖ Press the respective gray fields to enter the following dealer-related data:
 - Postal ZIP code
 - Location
 - Country
 - Phone number
 - Mobile number
- ❖ touch «To Next Page»



- the screen «Dealer Information 3» appears
- ❖ Press the respective gray fields to enter the following dealer-related data:
 - FAX number
 - E-mail address
 - Website
- ❖ touch «To Next Page»

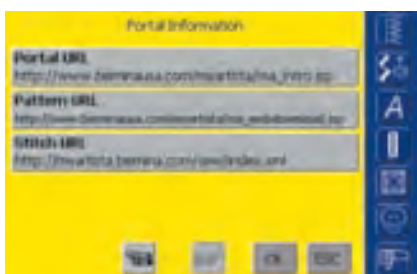

- the screen «Portal Information» appears
- these three Internet addresses are required and checked by the sewing/embroidery computer when connecting to the «myartista» portal
- if any of these addresses are changed by BERNINA, the others can be corrected by pressing the respective gray field
- these Internet addresses can not be used on the personal computer



Note
 These three Internet addresses must not be changed in any way unless BERNINA provides new respective data.

Messages and Audio Settings

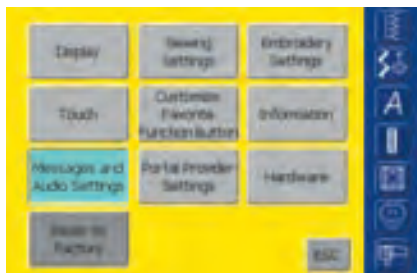

Opening Setup Program

- ❖ press the external Setup button
 - menu appears
- ❖ touch «Messages and Audio Settings»
 - the screen «Messages and Audio Settings Page 1» appears

Messages and Audio Settings Page 1



Audio System

- with this bar the sound can be activated or deactivated
- blue background and gray speaker means that the bar is active
- gray background and red speaker means that the bar is inactive

Test Speaker

- with this on-screen button the speaker function can be checked
- ❖ touch and release the button
 - a sound must be heard to indicate Audio System is active

Volume

- ❖ touching «+» or «-» changes the volume
- the number in the bar and the blue background of the «+» and «-» reflect the changes
- the «Default» on-screen button returns you to the basic settings

Selecting Stitch / Selecting Function

- the selection of stitches and functions can be indicated acoustically
- ❖ touch either the bar «Select Function» or the Sound button for selection of sounds
- 1-6 sound choices will be activated, both bar and Sound button are blue and the choice of selected sounds is indicated in the on-screen Sound button by a number (1-6)
- ❖ touch the Sound button one or more times and the six possible sounds can be heard (number changes from 1-6)
- ❖ the sounds can be turned off as follows:
- ❖ touch the bar «Select Stitch» and «Select Function» one or more times
- the bars will be inactive (gray) and the speaker symbols in the on-screen button «Sound» will be red

Messages and Audio Settings Page 2

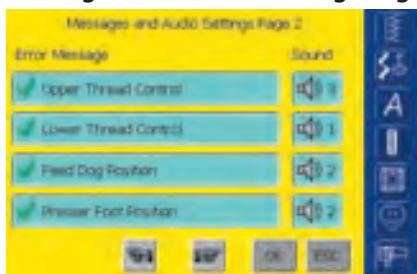

- ❖ touch «To Next Page»
 - the screen «Messages and Audio Settings Page 2» appears
- following messages can be turned on or off as well as indicated acoustically with the desired choice of sounds (1-6):
 - Upper Thread Control
 - Lower Thread Control
 - Feed Dog Position
 - Presser Foot Position
- the messages and choice of sounds can be turned on or off independently (i.e. a message can be turned on without any acoustic sound)
- blue background means that the bar or button is activated
- gray background means that the bar or button is deactivated

Messages and Audio Settings Page 3

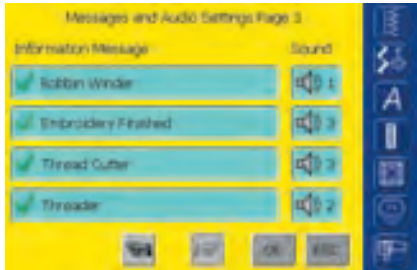

- ❖ touch «To Next Page»
- the screen «Messages and Audio Settings Page 3» appears
- following messages can be turned on or off as well as indicated acoustically with the desired choice of sounds (1-6):
 - Bobbin Winder
 - Embroidery Finished
 - Thread Cutter
 - Threader
- the messages and choice of sounds can be turned on or off independently (i.e. a message can be turned on without any acoustic sound)
- blue background means that the bar or button is activated
- gray background means that the bar or button is deactivated



To Next Page

- ❖ touch «To Next Page»
- the next screen appears



To Previous Page

- ❖ touch «To Previous Page»
- the previous page appears



Saving and Closing

- ❖ touch «OK»
- changes are saved, the screen closes and the menu appears



Closing Screen

- ❖ touch «ESC»
- the screen display closes, the original settings remain saved and the menu appears



Portal Provider Settings

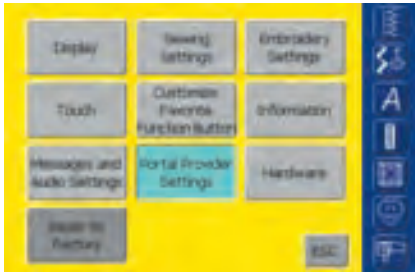

Opening Setup Program

- ❖ press the external Setup button
- menu appears
- ❖ touch «Portal Provider Settings»
- the screen «Portal Provider Settings» appears

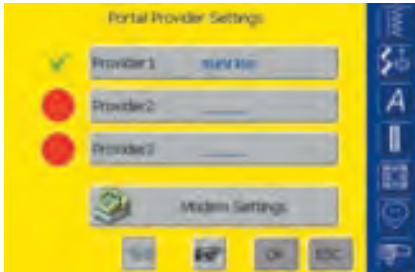

Portal Provider Settings

- the screen display contains the summary of the set providers (your provider's address)
- up to three different providers can be set - selection of provider may be made by touching the red circle, circle becomes a ✓
- ❖ touch the bar of the selected provider or «To Next Page»

Note:
For Modem settings see separate Modem instruction manual.

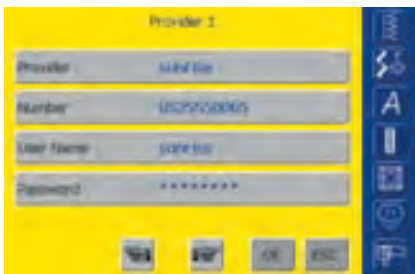

Provider 1

- the screen e.g. «Provider 1» appears, the provider settings are displayed
- the provider settings are made as follows:
- ❖ select an empty provider space on the screen «Portal Provider Settings», (e.g. Provider 3)



Provider 3

- the screen «Provider 3» appears
- ❖ touch the bar «Provider»

Note:
How to establish a connection from the Modem to a Portal provider see page 193.



- a screen with a keyboard appears
- ❖ the necessary information for this bar can be entered
- ❖ touch «OK»
- the entered information will be saved, the screen display closes and the screen «Portal Provider 3» appears again
- fill in all bars in this manner



Saving and Closing

- ❖ touch «OK»
- changes are saved, the screen closes and the menu appears

Hardware

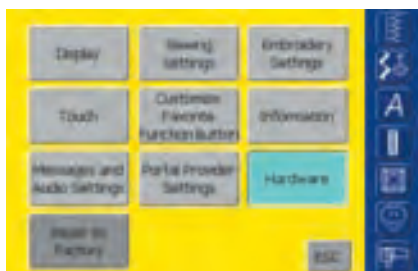

Opening Setup Program

- ❖ press the external Setup button
- menu appears
- ❖ touch «Hardware»
- the screen «SSID» appears

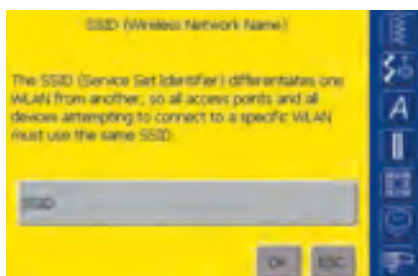

SSID (Service Set Identifier)

- ❖ touch SSID bar
- a screen with a keyboard appears
- ❖ enter SSID from your access point
- only necessary with a wireless application

Reset to Factory



Opening Setup Program

- ❖ press the external Setup button
- menu appears
- ❖ touch «Reset to Factory»
- a summary of the screen «Reset to Factory» appears

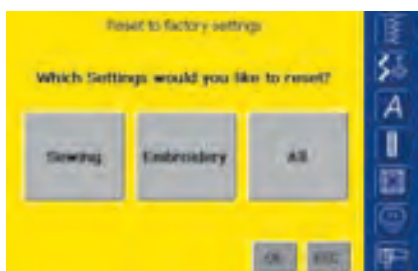

Reset to Factory

- three choices are possible:
 - Sewing
 - Embroidery
 - All
- ❖ touch the on-screen button which you want to «Reset to Factory»



Saving and Closing

- ❖ touch «OK»
- changes are saved, the screen closes and the menu appears



Closing Screen

- ❖ touch «ESC»
- the screen display closes, the original settings remain saved and the menu appears

Note:

If stock embroidery designs that came with the sewing computer are deleted, use the enclosed USB data stick to reload them to the sewing computer.





Help **178**

Tutorial **179**

Creative Consultant **181**

Balance **183**

- Balance for practical and decorative stitches
- Balance for sideways motion stitches

Cleaning and Maintenance **185**

Trouble Shooting **186**

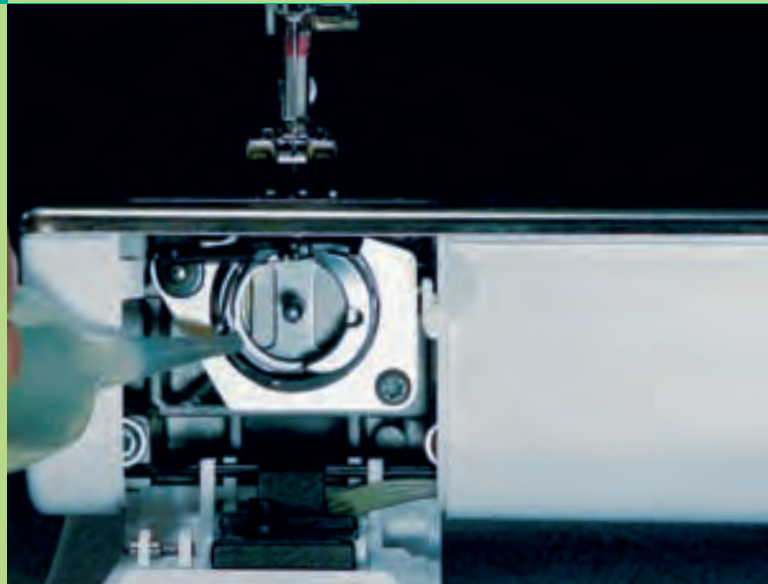

Sewing and Sewing Computer Support

Help Program

The Help program provides on-screen information on individual stitches and all functions on the screen, eliminating the need to regularly refer to the instruction manual. The information shown corresponds to information in the instruction manual, but is quicker and easier to find electronically.

No matter which screen is displayed, the help feature for stitches and functions of the screen can be opened. Touch «ESC» to return to the previous screen.

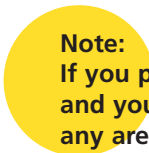

Note:
If you press the question mark symbol in sewing or embroidery mode, the motor stops and you can leave your sewing/embroidery computer. When resuming work, simply press any area in the display. This activates the motor and you can resume the sewing. The question mark symbol is now a multifunctional button which enables you to leave your sewing/embroidery computer without actually turning the machine off and on again. It also provides information on stitch patterns, embroidery designs and functions.



Opening Help

- ❖ touch Help «?» on the screen
- ❖ touch desired stitch or function

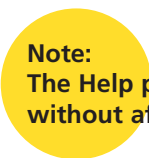

Note:
The Help program can be opened at any time without affecting the work at hand.

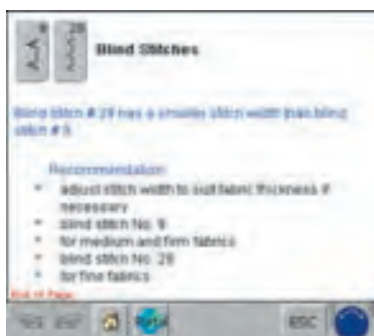

Help Screen/Stitches

the screen offers the following information:

- name of the stitch
- suitable fabrics
- brief listing of main applications

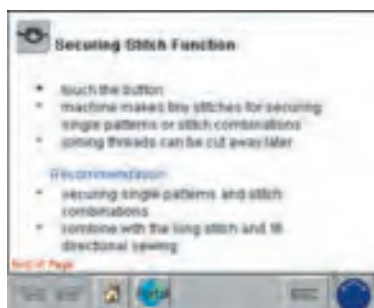

Help Screen/Functions

the screen offers the following information:

- name of the function
- explanation of the function
- brief listing of main applications

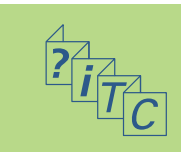

Text Scrolling

- this symbol indicates that text scrolling on screen can be activated with the stitch width or stitch length knob



Back to Previous Screen

- ❖ touch «ESC»
- Help is closed
- the previous screen appears

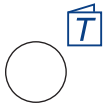

Opening Tutorial

- ❖ press external «Tutorial» button

Note:

In computer language, tutorial means self-help. The Tutorial provides concentrated on-screen information about various aspects of the sewing computer, eliminating the need to refer regularly to the instruction manual.



Subjects

- Main subjects appear:
 - Important facts about threading the sewing computer
 - Sewing techniques
 - Bernina-Stitch-Regulator BSR
 - Buttonholes
 - Peripherals
 - Embroidery module
 - FHS
 - Trouble Shooting
 - Presser Feet
 - Needles
- ❖ touch symbol (e.g. Presser Feet)



- Presser Feet subjects appear
- ❖ Select the desired subject (e.g. Change Presser Foot)

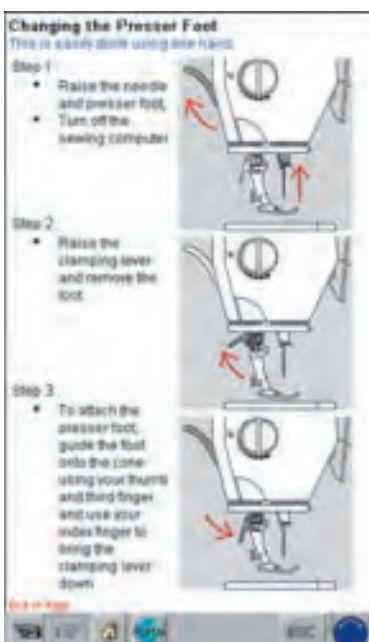

- Information on the desired subject appears

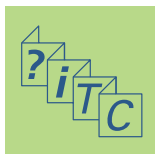



To Previous Page / To Next Page

- with the scroll arrows the previous or next page can be viewed



Back to Subjects

- ❖ touch the «Home» symbol
- the first screen (Subjects) of Tutorial appears



myartista Portal

- ❖ connect modem or Ethernet card
 - ❖ touch symbol
- Modem:
- ❖ confirm first message with «Yes» and second message with «OK»
 - the connection to the myartista Portal is made
- Ethernet Card:
- the sewing computer tries to find an active Internet connection
 - is the connection made, the «myartista Portal» site appears automatically



Video Tutorials

- ❖ touch the «Video» symbol
- the selected subject is demonstrated clearly by the aid of a video sequence

Note:
The Tutorial program can be opened at any time without affecting the work at hand.



Back to Previous Screen

- ❖ touch «ESC»
- Tutorial is closed
- the previous screen appears



Text Scrolling

- this symbol indicates that text scrolling on screen can be resumed with the stitch width or stitch length knob



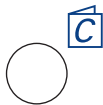

Opening Creative Consultant

- ❖ press external Creative Consultant button

The Creative Consultant provides information and help for a variety of sewing needs. After entering the type of fabric and technique you wish to use, the Creative Consultant provides suggestions regarding needles, presser feet, feed dog, stabilizers, presser foot pressure, etc. The suggested presser feet are not necessarily standard with the sewing computer but may be special accessories which can be obtained from your BERNINA dealer.

The Creative Consultant automatically sets the correct settings for the type of work selected:

- Thread Tension
- stitch width
- stitch length
- Balance
- Needle Position
- Needle Stop up/down
- the maximum sewing speed is adjusted according to the selected technique

Creative Consultant



Fabric Menu

- three columns of fabric types are displayed:
 - lightweight fabrics
 - mediumweight fabrics
 - heavyweight fabrics
- the most commonly used fabrics are listed in the three columns
- if the fabric you wish to use is not listed, select a similar type of fabric
- ❖ touch to select the desired fabric (e.g. jersey)

Techniques Menu

- several common sewing techniques appear on-screen:

Seaming

Blind hem

Invisible zipper

Freemotion machine quilting

Sideways motion patterns

Overcasting

Buttonhole

Decorative work (decorative stitches)

Hemstitching

Edgestitching

Visible Zipper

Machine quilting

Appliqué

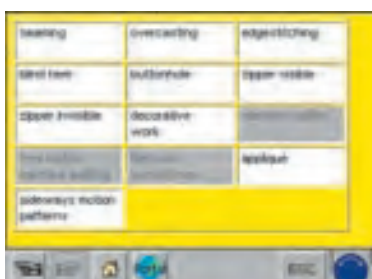

- ❖ touch to select the desired technique (e.g. buttonhole)
- ❖ if the technique you want to use is not listed, select a similar technique
- if a technique for the selected fabric is not recommended, the field becomes inactive (light gray)

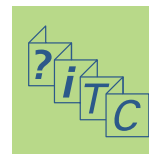



Information, Special Suggestions

- the third screen displays settings and suggestions for the type of fabric and technique you have chosen
 - Presser foot number(s)
 - Needle (size and type)
 - Presser foot pressure
 - Stabilizer needed
 - Feed dog position
 - Buttonhole cord (gimp)
- there may be several suggestions for the «Presser Foot» and «Needle» type
- the most suitable presser foot for the chosen technique is shown first
- further recommended presser feet are shown in brackets
- some presser feet suggested may be special accessories which are particularly suitable for the chosen technique (they may not be standard accessories, but can be purchased separately from your authorized BERNINA dealer)
- select the presser foot and needle according to your particular wishes and preferences
- a stabilizer will be suggested if it is required to suit the technique and fabric
- provides a reminder to use «Buttonhole Cord» (gimp) if necessary to reinforce a buttonhole
- further notes can be found under «Recommendation»
- «Tutorial Connections»: with these functions detailed information for further subjects can be opened directly in the Tutorial
- «Stitches»: programmed and alternative stitches with notes are listed here



To Previous Page / To Next Page

- with the scroll arrows the previous or next page can be viewed



Programmed Stitch

- ❖ touch «OK»
- the appropriate screen with the programmed stitch appears automatically



Back to Fabric Menu

- ❖ touch the «Home» symbol
- the first screen (Fabric Menu) of Creative Consultant appears



Back to Previous Screen

- ❖ touch «ESC»
- Creative Consultant is closed
- the previous screen appears



myartista Portal

- ❖ connect Modem or Ethernet Card
- ❖ touch symbol

Modem:

- ❖ confirm first message with «Yes» and second message with «OK»
- the connection to the myartista Portal is made

Ethernet Card:

- the sewing/embroidery computer tries to find an active Internet connection
- is the connection made, the «myartista Portal» site appears automatically



Text Scrolling

- this symbol indicates that text scrolling on screen can be resumed with the stitch width or stitch length knob

Note:

The Creative Consultant program can be opened at any time without affecting the work at hand.

All stitches are checked and fully adjusted before the sewing computer leaves the factory.

Different fabrics, threads, stabilizers and interfacings can affect programmed stitches so that they are not sewn out properly.

These effects can be corrected with the electronic Balance so that the stitch formation can be adjusted where necessary to suit the fabric.

Balance for Practical and Decorative Stitches 9mm

When sewing soft fabrics such as jersey or tricot, the fabric tends to stretch under the presser foot which also stretches the stitch being sewn. For example, the Honeycomb stitch opens up and is too long. Thicker fabrics might cause the stitch to overlap, making it too short. Correcting with the Balance is very easy.



Opening Balance

- ❖ touch the function «Balance»

Balance

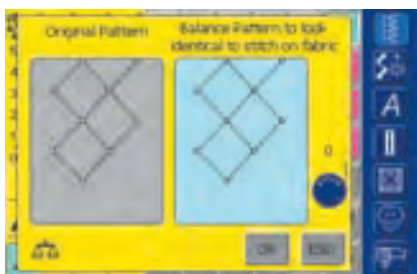

Balance Screen

- the special Balance screen opens
- in the left portion of the screen the stitch is displayed in its original form
- in the right portion of the screen the alterations made are directly visible
- the corrections can be made while sewing (with opened screen)



Corrections

- the stitch sewn on the fabric (e.g. the Honeycomb stitch) opens up and it does not look correct:
- ❖ turn the stitch length knob (displayed by a blue symbol on the screen) until the stitch in the right portion of the screen is identical with the stitch on the fabric

OK

Saving and Closing Screen

- ❖ touch «OK»
- the corrections will be saved and the Balance screen will close

Reset

Deleting Corrections

- ❖ touch «Reset»
- the corrections of the selected stitches will be deleted

ESC

Closing Screen

- ❖ touch «ESC»
- the Balance screen closes; returns to previous screen



Balance for Sideways Motion Stitches

Fabric, thread, stabilizers and interfacings can affect sideways motion stitches, so correcting with the Balance will sometimes be necessary.



Opening Balance

- ❖ touch the function button «Balance»



Balance Screen

- the special Balance screen opens
- in the left portion of the screen the stitch is displayed in its original form
- in the right portion of the screen the alterations made are directly visible
- the corrections can be made while sewing (with opened screen)

The stitch sewn on the fabric (e.g. stitch No. 201) is vertically and horizontally distorted:

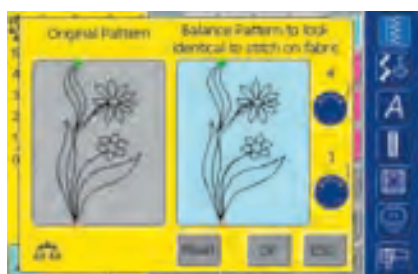

Vertical Corrections

- ❖ turn the stitch length knob (displayed by a blue symbol on the screen) until the stitch on the right portion of the screen is identical with the stitch on the fabric

Horizontal Corrections

- ❖ turn the stitch width knob (displayed by a blue symbol on the screen) until the stitch on the right portion of the screen is identical with the stitch on the fabric



Saving and Closing Screen

- ❖ touch «OK»
- the corrections will be saved and the Balance screen will close



Closing Screen

- ❖ touch «ESC»
- the Balance screen closes; returns to previous screen



Deleting Corrections

- ❖ touch «Reset»
- the corrections of the selected stitches will be deleted



Cleaning

If the sewing computer is stored in a cold room, it should be brought to a warm room about 1 hour before use.



Cleaning the Stitch Plate Area

Periodically remove thread lint and remnants which collect under the stitch plate and the hook.

- ❖ turn power switch to «0» (off) and pull out plug from electric outlet
- ❖ remove presser foot and needle
- ❖ open the free arm cover
- ❖ press the stitch plate down at the back right corner
- ❖ lift and remove stitch plate
- ❖ clean the area with the lint brush
- ❖ replace the stitch plate

! Refer to the safety instructions!

Cleaning the Screen

- ❖ wipe with a soft, damp cloth

Note:

BERNINA is committed to the protection of the environment. We strive to minimize the environmental impact of our products by continuously improving product design and our technology of manufacturing.

At end of life please dispose of this product in an environmentally responsible way according to the national directives. Do not throw away this product with your household waste. In case of doubt, please contact your dealer.

Cleaning and Maintenance

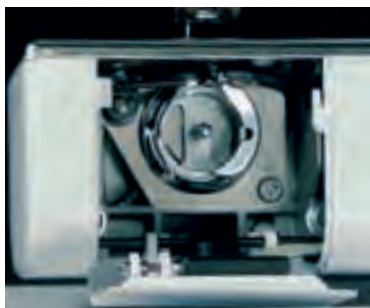

Cleaning the Hook

- ❖ turn power switch to «0» (off) and pull out plug from electric outlet
- ❖ remove the bobbin case
- ❖ clean the hook race using the brush provided or a cotton swab. The use of any sharp instrument could damage the hook
- ❖ insert the bobbin case

Cleaning the Sewing Computer

- ❖ wipe with a soft, damp cloth
- ❖ if very soiled, wipe with a solution of water and a few drops of liquid soap on a damp (not wet) cloth

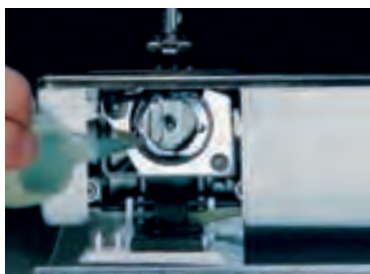

Lubricating

- ❖ turn power switch to «0» (off) and pull out plug from electric outlet
- ❖ squeeze 1 drop of oil into the hook race
- ❖ run the sewing computer for a short time without thread to prevent oil soiling your work

Important:

Never use alcohol or solvents of any kind to clean the sewing computer!

Replacing the Sewing Light



Contrary to an ordinary bulb, the CFL sewing light has a better illumination and a longer life.

Caution:

Please note that a defective CFL sewing light must ONLY be replaced by an authorized technician. The sewing computer must be brought to an authorized BERNINA dealer!



Prevention and Remedy of Failures

In most cases you will be able to identify and remedy faults by checking the following.

Check whether:

- the upper and lower threads are threaded correctly
- the needle is inserted as far up as possible with the flat side of the shank to the back
- the needle size is correct – check the needle/thread chart on page 18
- the sewing computer is clean – brush out any thread lint
- the hook race is clean
- any threads are trapped between the tension discs or under the bobbin case spring

Trouble Shooting

Upper Thread Breaks

Possible Faults:

- upper thread tension is too tight
- needle is of inferior quality; purchase needles at your authorized BERNINA dealer
- needle has been inserted incorrectly – the flat side of the shank must be to the back
- needle is bent or blunt
- poor quality, knotted, old or dried out thread has been used

Possible Solutions:

- use the correct spool disc
- stitch plate hole or hook tip damaged – take your sewing computer to your BERNINA dealer

Lower Thread Breaks

- the lower thread tension is too tight
- the bobbin is jammed in the bobbin case:
 - Remove and replace the bobbin
- the hole in the stitch plate has been damaged by the needle:
 - this must be polished by an authorized BERNINA service technician
- the needle is blunt or bent

Calibration of the Display

To open the calibration screen directly, proceed as follows:

- press both needle position buttons on the body simultaneously and keep them pressed
- turn on the sewing and embroidery computer
- as soon as the calibration screen is opened, release the two buttons
- Calibration of the Display see page 169

Skipped Stitches

- wrong needles used:
 - use only 130/705H system
- Needle is blunt, bent or incorrectly inserted:
 - Push right to the top when inserting
- needle is of inferior quality or badly polished
- the needle point does not suit the fabric being sewn; if necessary, use a ball point for knitted fabrics and a cutting point for hard leather
- for narrower stitches use a stitch plate with smaller stitch plate hole (5.5mm, optional accessory)

Needle Breaks

- needle clamp screw loose
- fabric pulled to the front instead of behind the presser foot
- when sewing over thick area, the fabric was pushed with the needle still in the fabric; use Jeans foot No. 18
- for more information regarding Needle see page 19

Faulty Stitching

- remnants of thread between the tension discs:
- pull folded, thin fabric (do not use fabric edge) between the tension discs and clean them by moving the fabric forwards and backwards on the left and right side of the thread tension
- remove remnants of thread under the bobbin case spring
- incorrect threading. Check upper and lower threads
- use the correct spool disc
- clean and lubricate hook (use only original oiler; see Cleaning and Lubricating page 185)

Cannot Sew Thick Fabric

- needle/thread combination is not correct (the thread is too thick for the inserted needle)
- use height compensating tool, when sewing over a thick seam

Sewing Computer Fails to Run or Runs Slowly

- plug not fully inserted
- turn power switch off («0»)
- sewing computer has been standing in a cold room
- restart sewing computer

Sewing Computer Sews in Reverse

- Continuous Reverse Sewing function is activated



Defective Sewing Light

- the sewing computer must be brought to a local BERNINA dealer

Problems With Peripherals

- plug not completely inserted
- restart sewing computer

Lower Thread Indicator Sensor

- bobbin cover is not closed
- not activated in the Setup Program
- remove any thread lint and remnants from the bobbin case

Upper Thread Indicator Sensor

- not activated in the Setup Program

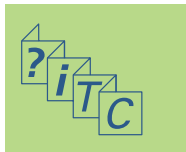

Messages

In special cases messages may appear on the screen. They serve as a reminder, warning, or confirmation of selected applications and functions.

Messages

- Security Program active.
Please deactivate before sewing.
- This number is not available in the sewing computer!
- Combi Mode does not support this pattern!
- Please switch feed dog to sewing position.
- Please check the upper and lower thread for thread breakage or empty bobbin.
- Please check lower thread. Please clean bobbin area of lint or stray thread. If bobbin is empty, please rewind bobbin.
- Please lower presser foot.
- Please raise the presser foot.
- For easier threading it is recommended that the presser foot is lowered.
- Needle will penetrate stitch plate or presser foot.
- The sewing/embroidery computer is not functioning correctly. Please contact your BERNINA dealer.
- During start-up an error occurred. Please restart the sewing/embroidery computer. If the problem persists please contact your BERNINA dealer.
- The BERNINA Modem cannot be identified. Please insert the Modem and try again.
- Cannot dial, please check the phone line and then dial number.

Notes

- Deactivate if required.
- Put in another stitch number.
- Inactive stitch patterns (gray stitch number) can not be selected in Combination mode. The sewing/embroidery computer does not respond when selecting one of those stitch patterns.
- Press the button «Drop feed dog». The message disappears automatically if the feed dog position was changed.
- Check upper and/or lower thread.
- Follow the instructions on the screen.
- The message disappears automatically if the presser foot was lowered.
- The message disappears automatically if the presser foot was raised.
- Lower presser foot.
- Check the settings in the Security screen.
- Contact your BERNINA dealer to solve the problem.
- Turn sewing/embroidery computer off and on again.
- The modem has not been recognised. Disconnect and reconnect modem.
- Check the settings in the Setup Program and try again.



Messages

- The authentication for the provider failed. Please check the username and the password.
- The communication with the provider was interrupted. Please try later or use another provider.
- An unknown error occurred with the Modem. Please try again.
- You cannot save or delete files on the myartista Portal.
- A problem occurred in communicating with the myartista Portal. Please try again.
- To keep your sewing/embroidery computer performing at its best, it's time to complete the following tasks. Remove thread and lint from beneath the stitch plate, as well as from the feed dog area. These instructions can be found on page 185 of the manual.
- It's time for your regular service check. Please contact your BERNINA dealer for an appointment.
- You have opted not to take your sewing/embroidery computer to your BERNINA dealer for its service check. This message will not appear until it's time for the next regular service.
- Please insert USB data stick that includes the video-film tutorials and press «OK».
- Main Motor failed. Please check hook system.

Notes

- Check the settings in the Setup Program and try again.
- Connecting problems occurred. Try to enter another provider if possible, or try again.
- Remove modem, then reconnect.
- The «myartista» portal provides tips and news.
- Try to connect to the «myartista» portal again. Remove and reconnect modem if necessary.
- This notification will appear after approx. 180,000 stitches. After cleaning/oiling clear the display by touching «OK». The display can be cleared temporarily by touching «ESC», but will appear again when restarting the sewing computer. After clearing with «ESC» for the third time, the cleaning notification will only appear again after a further approx. 180,000 stitches.
- The sewing computer must be taken for a service to a BERNINA dealer. The notification will appear after approx. 2,000,000 stitches. If the service was done by the BERNINA dealer, the stitch counter will be on «0» again and the display does not appear anymore. The display can be cleared temporarily by touching «ESC», but will appear again when restarting the sewing computer. After clearing with «ESC» for the third time, the notification will appear again at approx. 4,000,000 stitches.
- Flawless functioning of the sewing/embroidery computer can not be guaranteed if the servicing is not carried out at the recommended regular intervals.
- Connect the USB data stick to sewing/embroidery computer that includes video-film tutorials on various sewing techniques and topics.
- Open the bobbin cover. Remove any thread lint from the hook area/bobbin case.

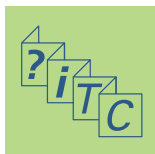

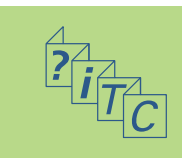

BERNINA Computer System **192**

Peripherals **192**

Connecting Peripherals **194**

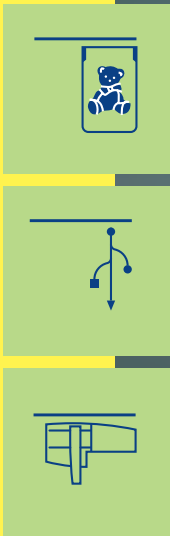

Connecting Peripherals

BERNINA Computer System

Connect peripherals (special accessories) to turn your **artista 730** embroidery computer into an embroidery computer system, and take your hobby to unsuspected heights of creativity.

In addition to a direct connection with the myartista Portal (information source) which takes you to the Portal site specially created for the embroidery computer, it is also possible, for instance, to watch additional video tutorials from a BERNINA USB Stick, or to turn your sewing computer into an embroidery computer by connecting the embroidery module.

Ask your BERNINA dealer for more information.

Peripherals

The following external devices can be connected to the artista 730 sewing computer:

- embroidery module
- BERNINA Modem
- BERNINA Ethernet Card
- BERNINA-USB Stick

Note:

All peripherals are special accessories, depending on country. Ask your BERNINA dealer for information!

Embroidery Module

The embroidery module is a great addition to the sewing computer. It provides unlimited scope for turning your creative ideas into reality.

Note:

Please note that the back section of this manual contains user instructions for the embroidery computer.

Modem / Ethernet Card (for access to myartista Portal)



The BERNINA Modem or Ethernet Card enables direct access to the myartista Portal (information source) where the special Portal pages, programmed for the sewing computer alone, can be called up onto the artista 730 screen.





Connecting via Modem

- ❖ connect Modem
- ❖ touch «Portal»
- ❖ confirm message about connecting with «Yes»
- ❖ when the connection to the Provider is made, then confirm the message that appears with «OK»
 - an overview of the myartista Portal site appears
- ❖ select desired page

Connecting via Ethernet Card

- ❖ connect Ethernet Card
- ❖ touch «Portal»
 - the sewing computer tries to find an active Internet connection
 - is the connection made, the «myartista Portal» site appears automatically

The content of the myartista Portal is continuously updated.

Note:

The BERNINA-Modem or the BERNINA-Ethernet Card includes user instructions!

Tutorial USB Stick



Open and view tutorial video-films from the Tutorial USB data stick on your sewing computer's screen.



When this function is visible in the toolbar on a selected Tutorial page, the application described can be viewed in a Video Tutorial.

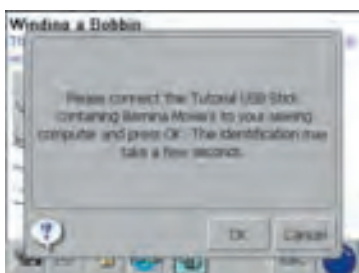

- ❖ touch symbol
 - if the desired Video Tutorial is not in the sewing computer, the message shown on the left appears
- ❖ connect Tutorial USB Stick
- ❖ touch «OK» and the Video Tutorial will start
- ❖ touch «ESC» and the Video Tutorial screen closes



Connecting Peripherals (Sewing Computer Compatible)



Connecting Peripherals

- ❖ plug external device into socket provided on the right hand side of sewing computer (look for symbol)

Caution:

You must only use BERNINA external devices with the BERNINA artista 730 sewing computer.

1 BERNINA Modem



Ask your BERNINA dealer!

2 BERNINA USB Stick



3 BERNINA embroidery module



Instructional/Presentations CD-ROM (for your PC)

This BERNINA CD-ROM is the presentation and instructional tool that takes you on a virtual journey around the highlights of the new BERNINA artista 730 sewing and embroidery system. Please insert it into your PC and enjoy using it to learn all about your artista 730.



Embroidery – Content

The Embroidery Computer

195–214

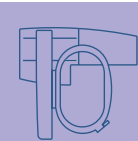

Important Embroidery Information

215–222



Embroidery

223–246



Saving and Deleting Motifs

247–252



Embroidery Support

253–258



Peripherals and Accessories

259–264





Setting up the Embroidery Computer **196**

- Details
- Standard accessories
- Special accessories

Attaching the Embroidery Module **199**

- Attaching the embroidery module to the sewing computer
- Protecting the embroidery computer from dust
- Connecting the adapter for free arm embroidery

General Operating Instructions **201**

- Preparing embroidery computer for embroidery
- Threading upper and bobbin thread

Selecting Embroidery Motifs **202**

- Welcome screen
- Embroidery motifs from the embroidery computer
 - Embroidery motifs from an embroidery card
 - Embroidery motifs from a CD-ROM
 - Embroidery motifs from the myartista Portal

Starting to Embroider **204**

- Selecting the embroidery hoop
- Attaching the embroidery hoop
 - Embroidering motifs

On-screen Functions and Displays **206**

- Selection menu
- Common functions and displays of Design Menu Edit 1 and Edit 2
 - Design Menu Edit 1
 - Design Menu Edit 2
- Embroidery Menu (Ready)

External Functions **213**

The Embroidery Computer

Details

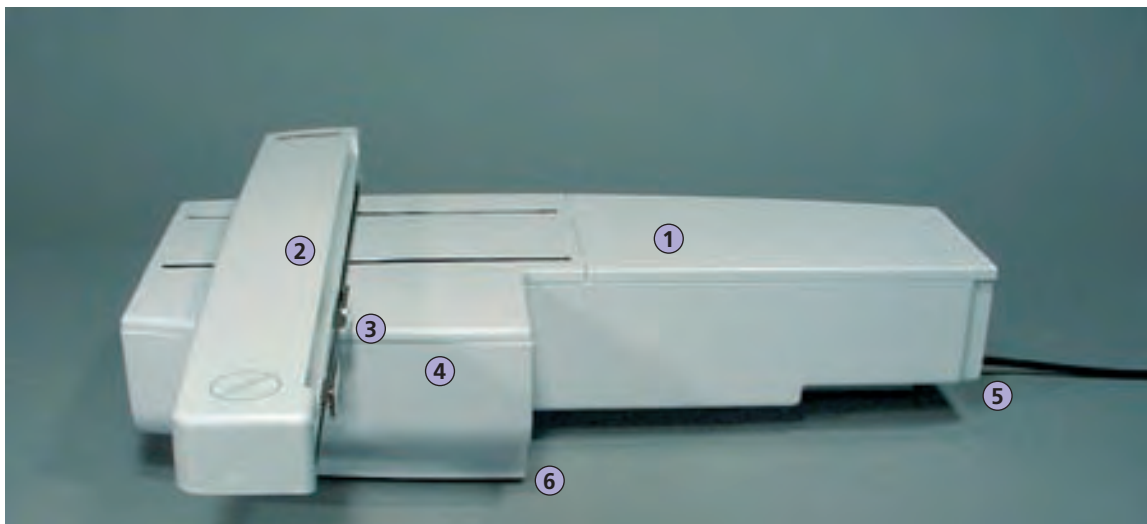
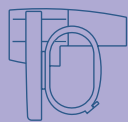

Front view

Setting up the Embroidery Computer

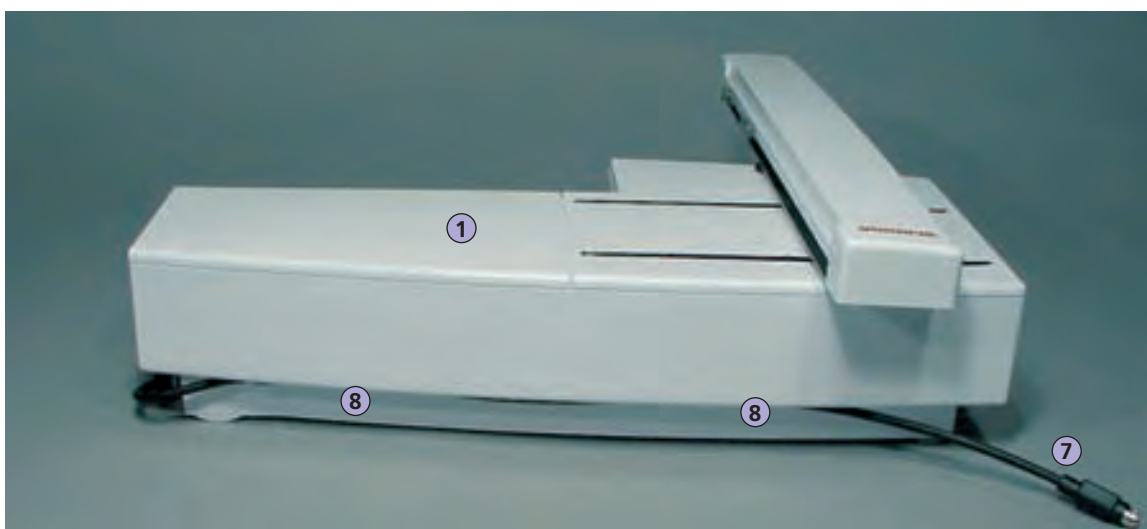

Back view

Note:

The side view (handwheel) of the sewing and embroidery computer with the connecting slot for embroidery cards and Modem, and the cable connections are shown on page 9 of the sewing computer instruction manual.

- 1 Embroidery surface
- 2 Embroidery arm
- 3 Embroidery hoop connection
- 4 Accessory box
- 5 Connecting lug right
- 6 Connecting lug center
- 7 Sewing computer connecting cable
- 8 Cable holder

Standard Accessories*



Large oval embroidery hoop (145x255mm) Template for large oval embroidery hoop
VAR. 00 for a730



Medium embroidery hoop (100x130mm) Template for medium embroidery hoop

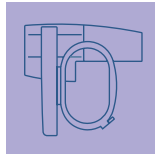

Small embroidery hoop (72x50mm) (for normal use and free arm embroidery). Blue template for normal embroidery. Red template for free arm embroidery



Adapter for free arm embroidery



Embroidery needle range



Embroidery presser foot No. 26. Net for upper thread spools - pull over upper thread spool for even spoling



Embroidery bobbin case



BERNINA Personal USB Memory Stick



Soft cover with pocket



USB connecting cable for PC embroidery software



Embroidery software Editor Lite

* can vary from market to market

Special (Optional) Accessories*

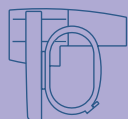

Suitcase system for sewing computer and embroidery module



Embroidery Mega-Hoop (150x400mm)
Template for Mega-Hoop
VAR. 00 for a730



Straight stitch plate



BERNINA embroidery cards



OESD Embroidery motif Stick



BERNINA Modem



BERNINA embroidery cards / Magic Box



BERNINA artista software



Ethernet Card



Multi Spool holder

* can vary from market to market

Attaching the Module to the Sewing Computer

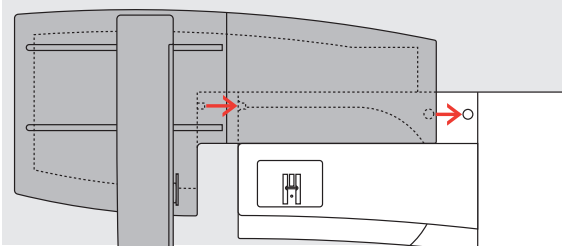

Attaching the Module to the Sewing Computer

- ❖ place the module on the sewing computer behind the free arm
- ❖ push the module from the left towards the sewing computer so that the connecting lugs engage in the base plate

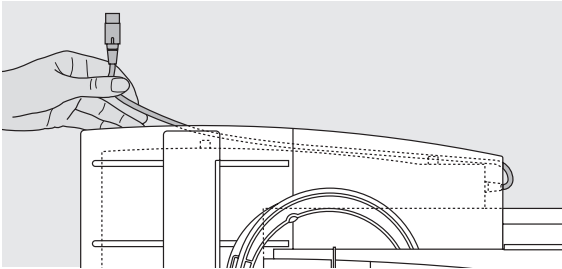
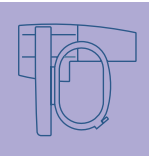

Releasing the Cable

- the cable connects the module to the sewing computer
- ❖ pull the cable out of the holder on the back of the module

Attaching the Embroidery Module

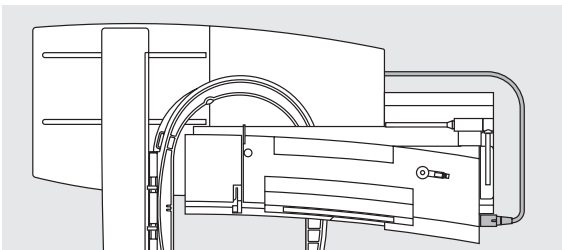

Connecting the Cable

- ❖ plug with flat side to the front
- ❖ insert the plug into the socket on the right hand side of the sewing computer (look for symbol)

Releasing the Cable

- ❖ pull out the plug

Storing the Cable on the Module

- ❖ insert the cable into both cable holders
- ❖ press cable gently to secure

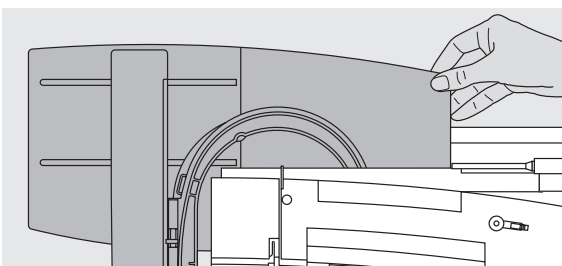

Removing the Module

- ❖ grip the back right corner to lift the module and remove to the left

Caution!
When connecting the embroidery module and/or the free-arm adapter, attention must be paid that all items are on a flat and even surface!

Caution!
Always separate the module and sewing computer for transportation. Never transport them attached.

Connecting the Adapter for Free Arm Embroidery

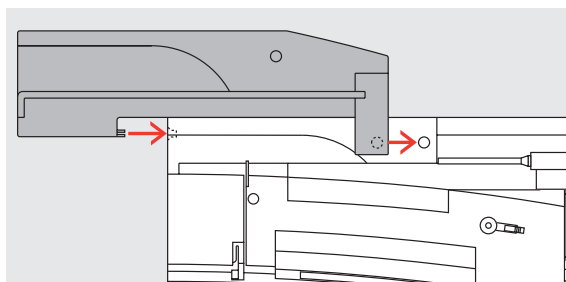
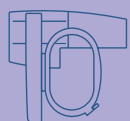

The adapter is used for embroidering tubular items (sleeves, trousers, infant items, socks, etc.) on the free arm of the sewing computer.

Attaching the Adapter to the Sewing Computer

- ❖ push the adapter behind the free arm towards the sewing computer so that the connecting lugs engage in the base plate of the sewing computer

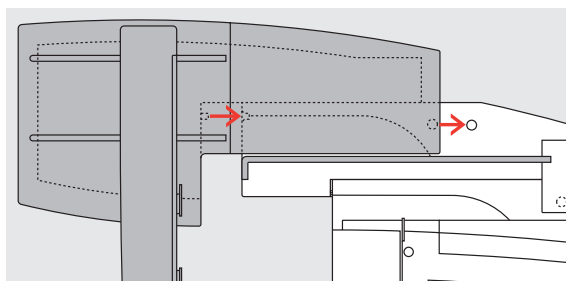

Attaching the Module to the Adapter

- ❖ place the module on the adapter with the front edge of the module as close as possible to the L-shaped guide on the adapter
- ❖ push the module towards the guide from the left until the connecting lugs engage in the base plate of the adapter

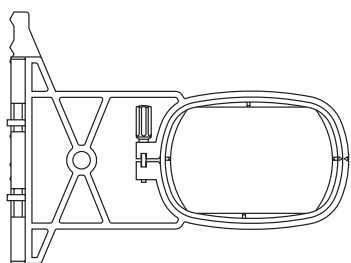

Free Arm Embroidery Hoop

- the small, oval embroidery hoop is specially designed for free arm embroidery

Caution!
Only the small hoop can be used for free arm embroidery.

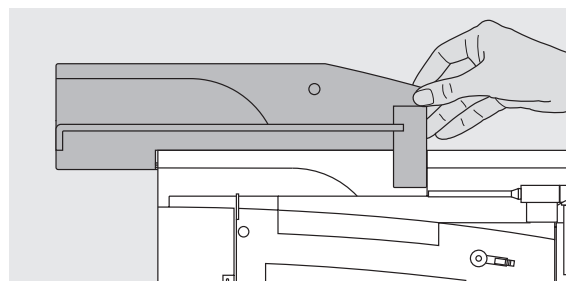

Removing the Adapter

- ❖ remove the module from the adapter
- ❖ the rear right corner of the adapter is designed to be used as a grip
- ❖ hold the adapter with this grip and remove from the base plate of the sewing computer

Preparing the Embroidery Computer for Embroidery



Embroidery Presser Foot No. 26

- ❖ attach the Embroidery presser foot No. 26
- ❖ raise the presser foot so that the embroidery hoop can be attached



Needles for Embroidery

- ❖ raise the needle so that the embroidery hoop can be attached

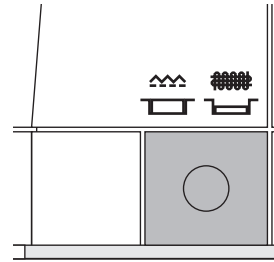

Lower the Feed Dog

- ❖ press the button on the right side of the sewing computer to lower the feed dog

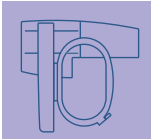

• for more information on Needles see pages 17-19

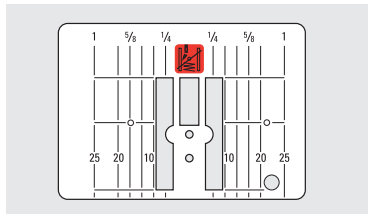

Straight Stitch Plate (optional accessory)

- the straight stitch plate has a small needle hole. The needle insertion points (upper and lower thread stitching) are limited, which produces a better embroidery result
- ❖ remove the standard stitch plate and replace it with the straight stitch plate

• for more information on Stitch Plates see page 17

General Operating Instructions

Threading Upper and Bobbin Thread

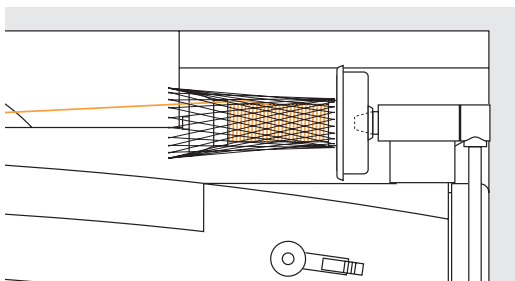

Threading the Upper Thread

- ❖ attach foam pad and place the upper thread spool
- ❖ when using Rayon or slippery embroidery threads, slip the net over the upper thread spool
 - this prevents the upper thread from slipping and gives an even thread feed

Threading the Bobbin Thread

- ❖ for embroidery, thread the bobbin thread through the pigtail tensioner of the embroidery bobbin case



Note:

Lower thread indicator sensor will only work when the bobbin cover is closed, after inserting the embroidery bobbin case. (Sensor has to be activated in the Setup Program.)

TIP

Spool pin

When using metallic or specialty threads, using the vertical spool pin and the supplementary thread guide (special accessory) may also help avoid problems.

Note:

While embroidering the bobbin can also be wound, just like in sewing (see page 13).

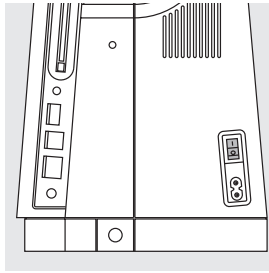
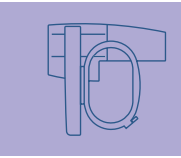

Switching the Embroidery Computer on

The **artista** embroidery system is operated with a combination of external buttons and knobs and a touch screen.

- ❖ turn power switch to «1» (on)



Welcome Screen

- after turning the embroidery computer on, the Welcome screen appears for a few seconds
- a message appears after the Welcome screen
- ❖ to close the message touch «OK»

Note:
The Welcome screen can be personalized in the Setup Program.

Selecting Embroidery Motifs

Selection Menu

- the Selection menu offers different sources to select motifs

Embroidery Motifs from the Embroidery Computer

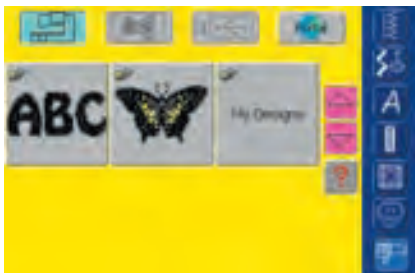

«Embroidery Computer» On-screen Button

- ❖ touch «Embroidery Computer» in the Selection menu
- built-in embroidery motifs can be selected with the on-screen buttons «Alphabets», «Motifs» and «My Designs»



Selecting Alphabets

- ❖ touch «Alphabets» in the Selection menu
- the different alphabets are visible on the display
- ❖ select one of the alphabets
- a screen with a keyboard appears

• for more information on Lettering see page 234



Selecting Motifs

- ❖ touch «Motifs» in the Selection menu
- the motifs appear in color on the display
- ❖ select a motif by touching the appropriate on-screen button



Selecting My Designs

- ❖ touch «My Designs» in the Selection menu
- the saved personal motifs appear in color on the display
- ❖ select a motif by touching the appropriate on-screen button

Embroidery Motifs from an Embroidery Card



«Embroidery Card» On-screen Button

- ❖ touch «Embroidery Card»
- the motifs of the embroidery design card (optional accessory) appear in color on the display (provided that a card is inserted)
- ❖ select a motif by touching the appropriate on-screen button

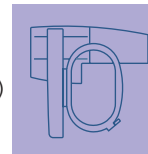

- for more information on Embroidery Cards see page 263

Embroidery Motifs from an USB Stick



«USB Stick» On-screen Button

- ❖ touch «USB Stick»
- the motifs on the USB stick (special accessory) appear on the screen in colour (provided that the USB stick is actually connected)
- ❖ select a motif by touching the appropriate on-screen button

Embroidery Motifs from myartista Portal



«Portal» On-screen Button

- ❖ touch «Portal»
- a special screen appears for the Modem connection (provided that the Modem is connected and you are connected to your service provider)
- if an Ethernet card (special accessory) is connected, the connection is made directly
- as soon as the Modem (optional) is connected, the motifs of the myartista Portal (information source) appear on the display
- ❖ select a motif by touching the appropriate on-screen button



- for more information on the myartista Portal see page 260

Selecting the Embroidery Hoop

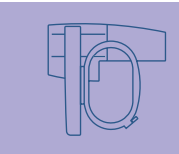

Screen Edit 1

- ❖ select an embroidery motif from the various choices of motifs
- the screen «Edit 1» appears



- the selected embroidery motif is shown in the most appropriate (smallest possible) hoop
- the «Hoop» on-screen button shows which hoop should be attached
- ❖ attach the recommended hoop

Note:

The last selected embroidery motif is always positioned in the center of the hoop.

Attaching the Embroidery Hoop

Raising Needle and Embroidery Presser Foot

- ❖ raise needle and embroidery presser foot
- ❖ hold the hoop with the right side of the fabric up and the attaching mechanism to the left

Starting to Embroider

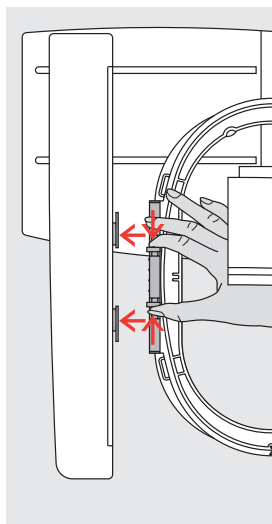

Attaching the Hoop

- ❖ pass the hoop under the embroidery presser foot
- ❖ squeeze the ends of the attaching mechanism on the side of the hoop
- ❖ position the center points of the hoop (small attachment clamps) over the bracket of the embroidery arm
- ❖ push the hoop down until it engages
- ❖ release the attaching mechanism of the hoop

Removing the Hoop

- ❖ press both ends on the hoop attaching mechanism towards each other
- ❖ pull up to remove the hoop

Embroidering Motifs



- ❖ touch «OK» in the screen Edit 1 or press the Quick Reverse button on head frame
- embroidery computer moves to check if hoop is attached



Embroidery Menu (Ready)

- the Embroidery menu (Ready) opens with the embroidery motif
- the embroidery motif is ready to be embroidered

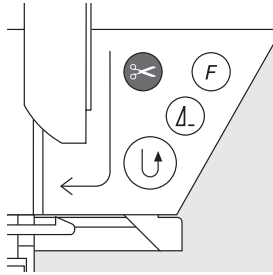

Starting to Embroider With the Quick Reverse Button on Head Frame

- ❖ lower the presser foot
- ❖ keep the Quick Reverse button on the head frame depressed until the embroidery computer starts
 - the embroidery computer will sew approximately 6 stitches and stop automatically
- ❖ raise the presser foot
- ❖ cut the thread tail at the beginning of motif
- ❖ lower the presser foot
- ❖ press the Quick Reverse button to resume embroidering

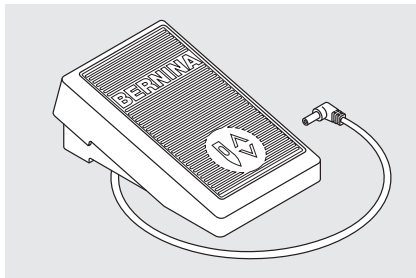
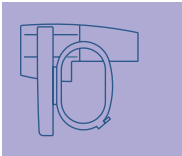

Starting to Embroider With Foot Control

- ❖ lower the presser foot
- ❖ press the foot control
 - the embroidery computer will stop automatically after approx. 6 stitches
- ❖ release the foot control
- ❖ raise the presser foot
- ❖ cut the thread tail at the beginning of motif
- ❖ lower the presser foot
- ❖ when embroidering using the foot control, it must continuously be pressed



Embroidery Screen

- after starting to embroider the Embroidery screen appears

Interrupting Embroidery

- ❖ when the embroidery computer is embroidering, press Quick Reverse button on head frame or tap the foot control lightly
- the embroidery computer will stop immediately

Completing the Color

- ❖ lower the presser foot again
- ❖ press Quick Reverse button or the foot control again
 - the embroidery computer embroiders all the sections in the color activated
 - the embroidery computer stops automatically when complete
 - both threads are automatically cut with the Automatic Thread Cutter
 - message appears "Color finished attach new thread"
 - acknowledge by touching «OK»

Changing Color

- the embroidery computer is automatically ready to embroider the next color
- ❖ change color of the upper thread accordingly
- ❖ embroider with the new color as described above

Cutting Thread Ends After Embroidery

- ❖ raise the presser foot
- ❖ remove the embroidery hoop from the embroidery arm
- ❖ cut away any remaining excess threads and connecting threads
- ❖ take care that the bobbin thread is not cut too closely to the stitch plate when removing the embroidery hoop

Selection Menu

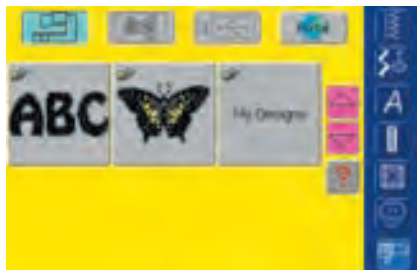
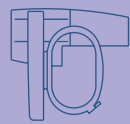

After turning on the embroidery computer or changing from Sewing to Embroidery Mode, the Selection menu appears. This happens when a motif is selected or combined with an existing motif.



Return to Selection Menu

- this function appears after selecting one of the following functions: «Alphabets», «Motifs» or «My Design»
- ❖ touch symbol
- Selection menu appears

On-screen Functions and Displays



Scroll Up

- ❖ touch symbol one or more times
- the screen content scrolls up to show more options
- ❖ touch the symbol continuously to scroll quickly



Scroll Down

- ❖ touch symbol one or more times
- the screen content scrolls down to show more options
- ❖ touch the symbol continuously to scroll quickly



«?» (Help) (double function)

- Question/Help about a function:
- ❖ touch symbol and select a function
 - a description of the selected function appears
 - ❖ close with «ESC»

Question/Help about a motif:

- ❖ touch symbol and select a motif
- a special screen appears which shows the following information on the respective motif:
 - name and motif format
 - width, height, embroidery time, stitch count and color number (can vary according to motif)
- ❖ from this screen the motif can be opened or deleted directly (or with «ESC» back to the Selection menu)



Closing Special Applications

- this function appears if changing from screen Edit 1 back to the Selection menu
- ❖ touch symbol
- the special application closes
- returns to previous screen



Spinning Spool

- the spinning spool shows that the embroidery computer is calculating
- no operations are possible during the calculation process

Note:

If you press the question mark the machine is «locked». If you touch the screen (anywhere) the machine will sew again.

Common Functions and Displays of Screens

Edit 1 and Edit 2

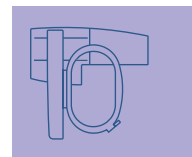

Screen Edit 1

After selecting a motif the screen Edit 1 appears. In this menu for example new motifs can be selected or combinations made by adding or duplicating.

Screen Edit 2

The screen Edit 1 has a sub menu called Edit 2 which is used to alter motifs (e.g. Rescale Motif Proportionally, Mirror Image, Rotate Motif, etc.).



Select Hoop

- display of the most appropriate hoop for the selected motif
- ❖ touch on-screen button
- the display «Select Hoop» appears
- each hoop size is displayed with maximum stitch field in mm



Possible Hoop Selections (display «Select Hoop»)

- ❖ select hoop (Small, Medium, Large Oval or Mega)
 - the display closes and the selected hoop is visible on the «Hoop» on-screen button
- ❖ press «Check Module» to calibrate the embroidery module (travelling to the reference points). **The embroidery hoop must not be attached when calibrating!**
- ❖ the display can be closed by touching the «ESC» on-screen button, without selecting a hoop



Check

- ❖ touch symbol
- the hoop moves vertically so that the size of the attached hoop may be read in the embroidery computer
- if only the hoop should be read, touch «Cancel»
- motif stitching area is read next with 4 stops
 - lower left
 - upper right
 - lower right
 - upper left
- ❖ acknowledge each stop with «OK»
- attached hoop is displayed
- if no hoop or a too small hoop is attached, an error message will appear



Motif Information

- ❖ touch symbol
- a screen appears which shows the following information on the activated motif:
 - width, height, embroidery time, color number and stitch count, thread colors and thread brand
- because of the complete overview on colors needed (scroll if necessary), the threads can be laid out ready before beginning embroidery

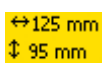

Motif Size

- display of motif width and height in mm



Motif Center

- ❖ touch symbol
- the center of the motif is displayed by the cursor
- the hoop will be moved until the needle is in the center of the motif
- ❖ touch symbol again
- on the display the first stitch of the motif will be marked again by the cursor



Embroidery Time

- display in minutes of the total embroidery time of the motif selected



Color Numbers

- display of the motif color numbers
- ❖ touch symbol
- the Color Motif display appears (the display closes by touching the symbol again)



Color Motif Display

- ❖ the color sequence can be scrolled with the arrows
- the display of the selected color is indicated in the Color Information bar as well as on the screen
- ❖ touch the Color Information bar
- the screen «Change Color/Brand to» appears
- the current thread color or brand can be changed

• for more information on Changing the Current Thread Color see page 240 ●●●●●●●●●●



Zoom

- ❖ touch symbol
- displays the motif enlarged by one step (zoomed in)
- ❖ touch symbol a second time
- displays the motif enlarged by a further step
- ❖ touch symbol «Scroll Zoomed Motif»
- ❖ with the stitch width or stitch length knob the motif can be scrolled to view
- ❖ touch symbol a third time
- reverts motif back to original size



Show Grid

- ❖ touch symbol
- a large cross hair indicates the hoop center
- ❖ touch symbol again
- because the grid now visible the motif can be positioned much better
- ❖ touch symbol again and the grid is switched off



Retrieve

- this function appears only when combining designs
- ❖ touch symbol
- switches between motifs when combining designs
- active motif is shown in color
- depending on how many times the function was touched, a motif or motif combination is shown active



«?» (Help)

- ❖ touch symbol and select a function
- the explanation of the selected function appears
- ❖ close with «ESC»



Embroidery Menu (Ready)

- ❖ touch «OK»
- the display changes from the screen Edit 1 or Edit 2 to Embroidery menu (Ready)
- the motif is ready for embroidery

Screen Edit 1



New Motif

- ❖ touch «New Motif»
- Selection menu appears
- ❖ select new motif or close display with «ESC»



Add Motif

- ❖ touch «Add Motif»
- Selection menu appears
- ❖ select new motif or lettering of your choice or close display with «ESC»
- motif is added to motif on screen



Duplicate Motif

- ❖ touch «Duplicate»
- the selected motif on screen will be duplicated automatically



Delete

- this function only appears when combining designs
- ❖ touch symbol
- deletes the activated motif, the next one appears in color



Save

- ❖ touch symbol
- the "Save" screen appears



To Next Page - Edit 2

- ❖ touch symbol
- the screen Edit 1 changes to the screen Edit 2

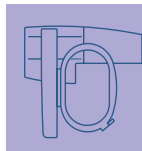

- for more information on Saving see pages 248-251

Screen Edit 2



Move Motif

- ❖ touch symbol
- the purple knob icons for operating the stitch width and length knob appear
- ❖ to move the motif horizontally, turn the stitch width knob - to move right turn knob clockwise - to move left turn knob counter clockwise
- ❖ to move the motif vertically, turn the stitch length knob - to move up, turn knob counter clockwise - to move down, turn knob clockwise
- in the purple knob icon the alteration is displayed in 1/10 millimeter (mm)
- ❖ to move the motif diagonally turn the stitch width and length knob (the number in both purple knob icon is the same)
- ❖ to re-center the motif touch the purple knob icon or touch «Move Motif» again
- ❖ touch «Move Motif» twice and a duplicated motif is centered



Rotate Motif

- ❖ touch symbol
- the purple knob icon for operating the stitch width knob appears
- ❖ to rotate the motif clockwise, turn stitch width knob clockwise
- ❖ to rotate the motif counter clockwise, turn the stitch width knob counter clockwise
- display of the position in degrees (°)
- ❖ to reactivate the default setting (0°/360°) touch the purple knob icon
- ❖ touch «rotate motif» several times and rotate motif clockwise in 90° steps (0°/90°/180°/270°/360°)



Rescale Motif Height or Width

- ❖ touch symbol
- the purple knob icons for operating the stitch width and length knob appear
- ❖ to adjust the width of the motif (horizontally), turn stitch width knob clockwise to increase width and counter clockwise to decrease width
- ❖ to adjust the height of the motif (vertically), turn stitch length knob clockwise to increase height and counter clockwise to decrease height
- display of the adjustment in percent (%)
- ❖ to reactivate the default setting (100%) of the motif touch the purple knob icon



Rescale Motif Proportionally

- ❖ touch symbol
- the purple knob icon for operating the stitch width knob appears
- ❖ to enlarge the motif turn stitch width knob clockwise
- ❖ to reduce the motif turn stitch width knob counter clockwise
- display of the alteration in percent (%)
- ❖ to reactivate the default setting (100%) of the motif touch the purple knob icon



Horizontal Mirror Image (left/right)

- ❖ touch symbol
- the motif will be mirrored vertically (left/right)



Vertical Mirror Image (up/down)

- ❖ touch symbol
- the motif will be mirrored horizontally (up/down)



Motif Properties

- with the Motif Properties function the following is possible:
 - altering the stitch density of stitch types
 - Pull Compensation: adjusting excessive spacing/overlap of motif
 - Run Length: altering outline length
- ❖ touch symbol
- a special display appears



- ❖ alter stitch density (satin stitch, step stitch, decorative stitch fills (Fancy Fill))
 - touching «+» increases the stitch density
 - touching «-» reduces the stitch density
 - display of the alteration in percent (%)
- ❖ adjusting Pull Compensation
 - touching «+» increases the Pull Compensation value to decrease excessive spacing between objects and/or outlines caused by the push and pull effect of fill stitches
 - touching «-» decreases the Pull Compensation value to eliminate excessive overlap of objects and/or outlines caused by the push and pull effect of fill stitches
 - display of the alteration in 1/10 millimeter (mm)
- ❖ altering Run Length (outline)
 - lengthen Run Length by touching «+»
 - shorten Run Length by touching «-»
- ❖ confirm entry by touching «OK»
 - display of the alteration in 1/10 millimeter (mm)

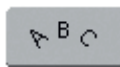

Letter Manipulation

- ❖ touch symbol
- a special display appears



- ❖ to insert lettering touch the Text bar
 - a screen with a keyboard appears
- ❖ to change the alphabet type scroll next to the Alphabet symbol
 - the alphabet type changes in the display
- ❖ to alter lettering size scroll with arrows next to the Height box
 - alteration is shown in millimeter (mm)
- ❖ to change the baseline type of lettering touch the desired on-screen button
 - horizontal baseline
 - circle counter clockwise produces lettering below the curved baseline (three different forms of arched lettering are possible, the larger the green circle the less the arch)
 - circle clockwise produces lettering above the curved baseline (three different forms of arched lettering are possible, the larger the green circle the less the arch)
 - vertical baseline
- ❖ use up or down arrows to change letter spacing in mm steps between letters



To Next Page - Edit 1

- ❖ touch symbol
 - Screen Edit 1 appears

Note:

The last activated function in Edit 2 (Move Motif, Rotate Motif, Rescale Motif Height or Width and Rescale Motif Proportionally) can still be changed when switching back to screen Edit 1.

Embroidery Menu (Ready)



In the Embroidery menu (Ready) the motif can be embroidered and embroidery related alterations made (e.g. adjusting thread tension, reducing motor speed, etc.).

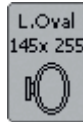

Hoop Display

- display of the attached embroidery hoop with stitch field dimensions in mm

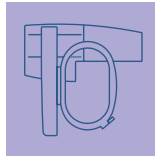

Hoop Relocator

- this function makes threading easier if the thread has to be changed when the needle is very close to the left edge of the hoop
- ❖ touch symbol
- the hoop moves horizontally to the center, a message appears
- ❖ rethread
- ❖ touch «OK» and the message will close
- the hoop moves back to the previous position
- ❖ touch the Quick Reverse button
- the embroidery computer continues to embroider

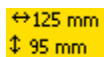

Motif Size

- display of the motif width and height in millimeters (mm)



Embroidery Time

- display in minutes of the total embroidery time of the motif selected

Embroidery Time



- display of the total (and remaining) embroidery time of the motifs on the upper bar
- Number in upper bar:
- the left number indicates how many stitches there are in the active motif/motif combination
- the right number indicates the total stitch count of the active motif/motif combination
- display of the embroidery time of the active color in the lower bar
- stitch time on both bars counts down as embroidery progresses

Color Information Bar



- information on the current thread color:
 - display of the current thread color
 - position of the current thread color (1st number)
 - number (2nd number)
 - color number of the selected thread brand
- ❖ right and left arrow change the current thread color
- ❖ touch the Color Information bar
- the hoop moves to first stitch of current thread color (a cursor icon appears in the Color Information bar)
- the current (active) color can also be individually embroidered by touching the Color Information bar



Thread Tension (Alteration)

- ❖ touch symbol
- the Thread Tension screen appears
- the Thread Tension can be altered as desired
- the selected setting is visible in the on-screen button



To Screen Edit 1

- ❖ touch symbol
- the screen changes from the Embroidery menu (Ready) to the screen Edit 1

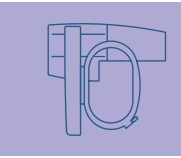

Embroidery Speed $1/4$, $1/2$, $3/4$, $4/4$

- ❖ touch symbol one or more times
 - the desired speed will be selected
 - the bar on the symbol shows the alteration
 - reduces or increases the Embroidery Speed proportionally
- ❖ touch the symbol longer and the default speed ($4/4$) is set again



«?» (Help)

- ❖ touch symbol and select a function
 - the explanation for the selected function appears
- ❖ close with «ESC»



Single/Multi Color Motif

- ❖ touch symbol
 - if the symbol is active, the complete motif will be embroidered in one color (without stopping)
 - if the symbol is inactive, the colors will be embroidered individually



Embroidery Sequence Control (i.e. thread breakage)

- ❖ touch symbol
 - the Information Area for operating the stitch width knob appears
- ❖ to check the embroidery sequence of the motif in stages turn stitch width knob
 - the needle follows the embroidery sequence in small steps
- ❖ to follow the embroidery sequence forwards, turn the stitch width knob clockwise
 - the number in the Information Area shows the stitch count of the embroidery sequence
- ❖ to follow the embroidery sequence backwards, turn the stitch width knob counter clockwise
- ❖ to reactivate the default setting touch the purple knob icon



Move Hoop

- ❖ touch symbol
 - the Information Areas for operating the stitch width and stitch length knob appear
- if the fabric of a large motif has to be rehooped (e.g. lettering, border, etc.), the hoop can be moved to the last stitch of the already embroidered part of the motif by turning the knobs



Starting Embroidery With Quick Reverse Button on Head Frame

- ❖ touch Quick Reverse button on head frame to start embroidery
- ❖ to enter the Embroidery menu directly from the Design menu touch the Quick Reverse button on head frame

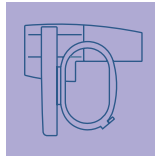

Automatic Thread Cutter

- when a color finished embroidering, upper and lower threads are automatically cut

External Functions



Stitch Width / Stitch Length Knobs

- ❖ with different functions such as Thread Tension, Alter Size, Rotate Motif, etc. the external knobs are used to work on the motifs
- an Information Area appears if the knobs can be operated



Embroidery Mode/ Sewing Mode Button

- ❖ changing from Embroidery Mode to Sewing Mode and vice versa



In General **216**

Embroidery Threads **218**

Embroidery Stabilizers **219**

Hoopings the Fabric **221**

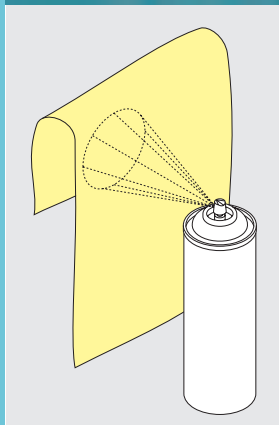

Important Embroidery Information



Choosing an Embroidery Motif

- simple motifs with a low stitch count are suitable for embroidery on fine fabric
- large-scale, densely embroidered motifs (e.g. with multiple color and embroidery direction changes) are suitable for medium- and heavyweight fabrics

Embroidery Test

- ❖ always stitch an embroidery test on a sample fabric. Adjust color, thread quality, needle, stitch density, tension, etc. to suit the motif if necessary
- ❖ for the test use the same fabric and stabilizer that you will use on the project

Scaling/Sizing Motifs

- motifs can be scaled/sized with artista software either on the embroidery computer or on the PC
- to get good results, the motifs should be scaled within the limits of 75% to 150%

In General

Different Stitch Types

Underlay Stitches

Underlay stitches are the foundation of a motif and are used to stabilize the base fabric and hold it in shape. They also prevent the covering stitches of the motif from sinking into the knit or the nap of the fabric. They are accomplished automatically in the built-in designs for **artista 730** and in artista Design cards.



Fill Stitches

Satin Stitch

- this stitch sews a dense zig-zag so the thread covers the motif
- satin stitches are suitable for filling small and narrow areas. They are not suitable for filling large areas, as long stitches are too loose and do not cover the fabric properly. In addition there is the danger that with too long stitches the threads could catch on something which would damage the embroidery



Step Stitch

- a fill stitch with stitches of specified length sewn in rows used primarily to fill large areas quickly



Fancy-Fill Stitches

- to give areas a special effect
- stitches that create a motif with an area to be filled



Outline Stitches

- usually straight or satin stitches
- used to define a specific area or areas
- examples are: straight stitch, double run, triple run, satin



Jump Stitches

- long stitches that skip over fabric after one part of the motif finishes and the next begins
- before and after the jump stitch securing stitches are sewn
- jump stitches are trimmed before the next color starts to embroider



Embroidery Threads

One of the most important elements in successful embroidery is the quality of the thread. We strongly recommend that you purchase thread from a reputable BERNINA dealer in order to avoid irregularities, thread breakage, etc. which so often occur with poor quality threads.



Polyester Threads

Polyester with a brilliant sheen is a hard wearing colorfast thread and has a high tensile strength. It is suitable for all types of embroidery, especially children's clothing and items which will be washed often or subject to much wear and tear.

Embroidery is particularly effective if you use glossy rayon or polyester embroidery threads as upper threads. They are available in a wide range of colors for beautiful embroidery.



Embroidery Threads

Rayon Threads

Rayon is a soft viscose fiber with a brilliant sheen and suitable for fine, delicate embroidery, or items that will not receive excessive wear and tear.

Metallic Wrapped Polyester Thread

Metallic thread is a light- to mediumweight thread suitable for special effects in embroidery. Preferably use with a Metafil 130/705 H-MET needle or Organ needle of varying sizes.

Embroidery Needle

- ❖ correct size thread must correspond with correct size needle
- ❖ replace needle regularly

Bobbin Threads

Bobbin-Fil (Special Bobbin Thread)

Bobbin-Fil is an especially soft and light polyester thread suitable for bobbin thread. This special bobbin thread ensures a steady thread tension and an optimal intertwining of the upper and bobbin thread.

Darning and Embroidery Thread

Fine mercerized cotton thread suitable for embroidery (Mettler 60 weight suggested), which is embroidered on cotton fabric.

TIP

When using metallic threads or other specialty threads we recommend to use the vertical spool pin for smooth unwinding.

- for more information on Needles see pages 17-19



TIP

Use white bobbin thread or match color with fabric.

Tear-away Stabilizers

- similar to interfacing; tears like paper
- one or more layers can be used
- comes in different weights
- ❖ for more stability, apply to the wrong side of the fabric with temporary spray adhesive before hooping
- ❖ carefully tear away excessive stabilizer from the back of the embroidery after stitching
- stabilizer will remain under larger embroidered areas

Application:

- for all woven fabrics and fabrics which are not elastic

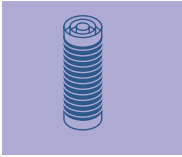
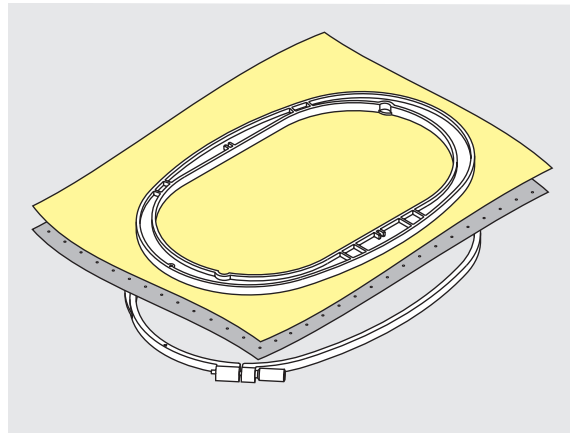

Cut-away Stabilizers

- one or more layers can be used
- comes in light- and heavyweight
- ❖ for more stability, apply to the wrong side of the fabric with temporary spray adhesive before hooping
- ❖ carefully cut away from the back of the embroidery after stitching
- stabilizer will remain under larger embroidered areas

Application:

- for all elastic fabrics, especially suited for knits

Iron-on Interfacing

- ❖ must be preshrunk by soaking in warm water
- this is pressed (fused) to the wrong side of the fabric
- iron-on interfacings are available in a variety of weights and should be selected to suit the fabric being used
- removable iron-on interfacing is also available

Application:

- to provide body and shape for fabrics onto which motifs will be placed
- use in conjunction with appropriate stabilizer

Embroidery Stabilizers

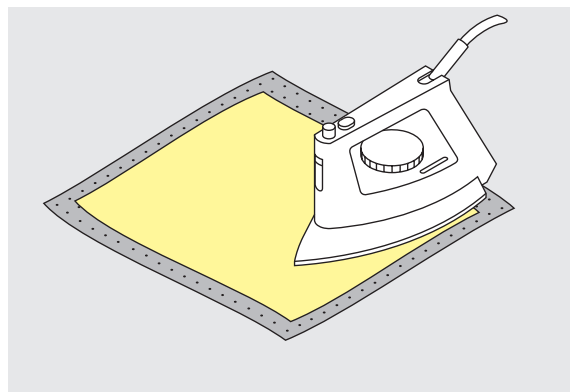

Paper Backed Adhesive Stabilizer

- ❖ place stabilizer in hoop, paper side up
- ❖ use a pointed object (e.g. scissors) to score the paper and remove it to reveal the self-adhesive surface
- ❖ position the piece of fabric to be embroidered on the stabilizer

Application:

- intended for delicate fabrics such as jersey or silk
- for hard to hoop sections and fabrics such as velvets

Note:

When using paper backed adhesive stabilizer make sure that the adhesive residue on needle, stitch plate and hook area is removed.

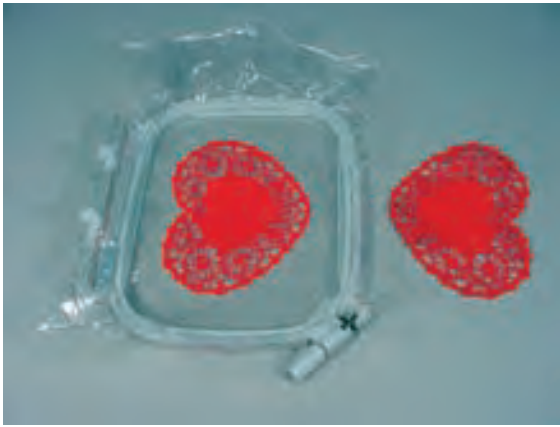

Water Soluble Stabilizer for Fabric With a Pile and Lace Embroidery

- water soluble stabilizer looks like plastic wrap
- dissolve stabilizer in warm water when embroidery is complete
- water soluble stabilizers are ideal protection for fabrics with a thick or looped pile such as toweling
- ❖ place on top of toweling and high nap fabrics backed by appropriate stabilizer for fabric and motif. This also prevents the threads from sinking into the fabric and prevents fabric from showing between embroidery stitches
- ❖ use spray adhesive to fix stabilizer if necessary
- ❖ for fabric with a pile, reinforce with additional, suitable stabilizer on the wrong side if necessary
- ❖ for lace embroidery place one or two layers of water soluble stabilizer in hoop (as the motif is not embroidered on any fabric, only the thread embroidered motif is left)
- ❖ after dissolving lay the motif down flat and let dry
- ❖ water soluble stabilizer can also be removed by gently tearing it away when used as a topping on non-washable fabrics like velvet

Application:

- ideal for toweling, velvet, bouclé knits, etc.
- ideal for fine, sheer fabrics such as organdy, batiste, etc.
- recommended for use as a stabilizer with low stitch count motifs
- use heavier water soluble stabilizer to stitch lace motifs

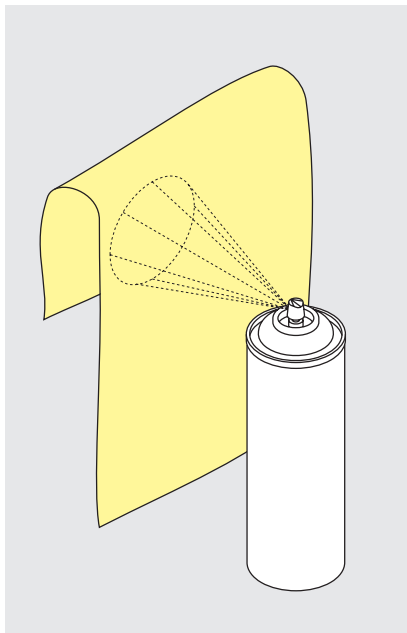

Adhesive Spray

- Please avoid using adhesive spray next to your embroidery system
- for more stability, spray the stabilizer and adhere to the wrong side of the fabric carefully smoothing fabric so there are no puckers
- Use adhesive carefully and spray from a distance of 25cm - 30cm (9.8 inches to 11.8 inches)

Usage:

- Stretch and knitted material: to retain shape
- Appliqué: position appliqués perfectly
- Two or more pieces of fabric: avoid slipping of fabric layers
- Fabric pieces: position fabric pieces on stabilizer, i.e. pocket flaps
- Napped fabrics (i.e. velvet) that should not be clamped in the hoop because of the possibility of getting hoop marks

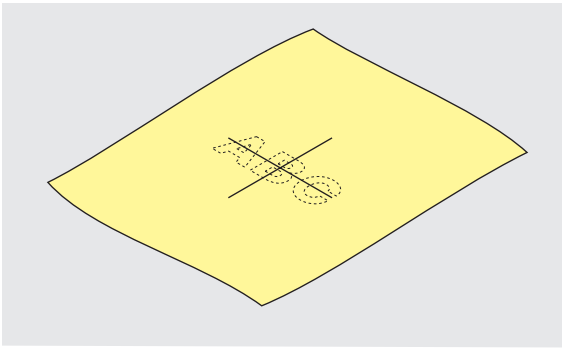

Centering

- ❖ determine the center of the fabric to be embroidered
- ❖ mark with a fabric marker or chalk

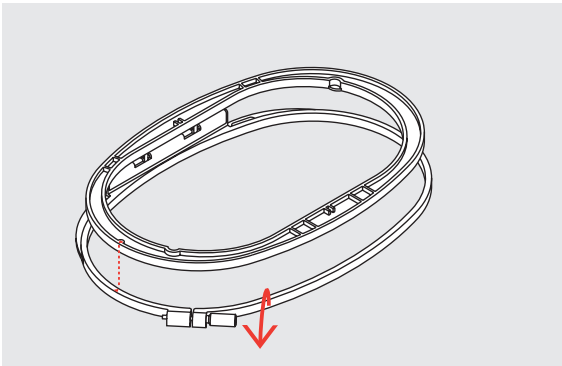

Using the Embroidery Hoop

- ❖ loosen the screw(s)
- ❖ remove the inner hoop
 - the arrows on both hoops should match
 - the arrows on the medium, large and Mega hoops are at the center front and on the right hand side of the small hoop

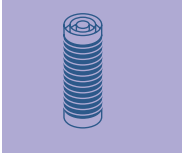

Hooping the Fabric

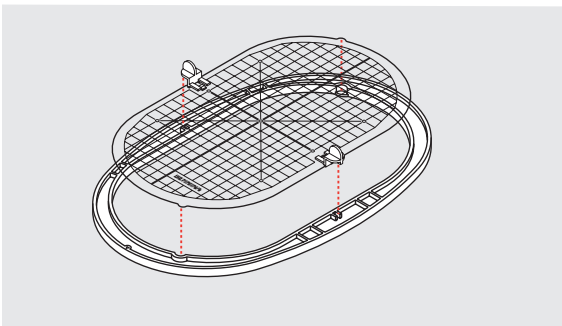

Embroidery Template

- there is a template for each embroidery hoop, the small hoop has two
- the embroidery surface is marked in 3/8" (1 cm) squares
- the center and corners are marked with holes for transferring marks to fabric
- ❖ place the template in the inner hoop so that the word BERNINA is at the front (by the arrows) and can be read
- the template will engage automatically in the inner hoop
- there are finger holes for removing the template from the small and medium hoops, and special attachment clips for the large and Mega hoop templates

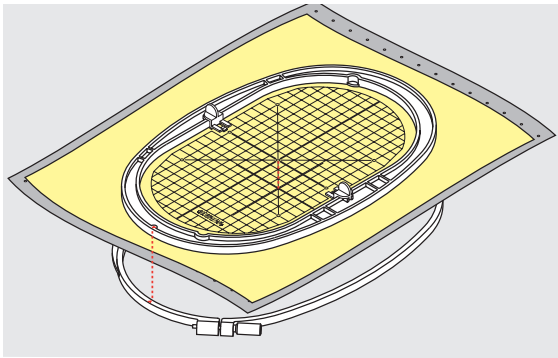

Hooping the Fabric

- ❖ place fabric on top of the outer hoop
- ❖ place the marked center point in the center of the template on inner hoop
 - match the arrows of inner and outer hoops
- ❖ place inner hoop on top of fabric and outer hoop and press into place, loosening screws to accommodate fabric. Tighten screws
- ❖ remove template

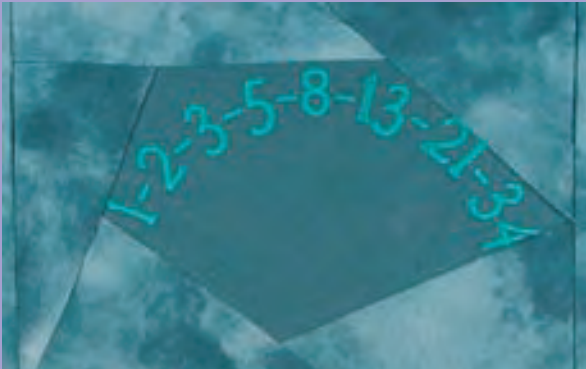

Motifs 224

- Embroidering
- Positioning
- Altering: mirroring, size
- Combining

Alphabets – Lettering 234

- In general
- Combining lettering

Adjustments 240

- Motif colors
- Adjusting motifs

Applications 243

- Free arm embroidery
- Lace
- Borders
- Shadow Embroidery

Embroidery

In General

All motifs can be either embroidered directly or can be combined with the different functions offered by the embroidery computer.

Apart from combining designs, it is also possible to rotate the motifs, to alter the stitch density, to allocate another thread color, etc.



Motifs

Basic Information on Embroidering Motifs With no Alterations

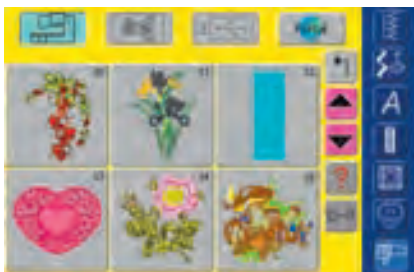

Motif Information

Valuable information about the desired motif is available in the Motif Selection menu:

- ❖ touch the function «?» (Help) and select desired motif



- in the opened special screen «Design Information», the following information on the selected motif is available:

- Name
- Width
- Height
- Embroidery Time
- No. Stitches
- No. Colors

- ❖ touch «Open»

- the motif appears in the screen Edit 1



Select Hoop

The most appropriate (smallest possible) hoop is automatically chosen for the selected embroidery motif:

- the motif is shown on the display in the center of the most appropriate hoop
- «Select Hoop» also shows the most appropriate hoop



View Motif in Detail (Zoom)

A detailed viewing of the motif is possible with the Zoom function:

- ❖ touch symbol once
 - displays the motif enlarged by one step (zoomed in)
- ❖ touch symbol a second time
 - displays the motif enlarged by a further step, in addition the function «Scroll Zoomed Motif» appears



- ❖ touch symbol «Scroll Zoomed Motif»
 - the Information Areas for operating the stitch width and length knob appear
- ❖ detailed viewing of the individual parts: scroll zoomed motifs horizontally or vertically by turning the appropriate knob
 - stitch width scrolls right/left
 - stitch length scrolls up/down
- ❖ by touching symbol a third time, reverts motif back to original size

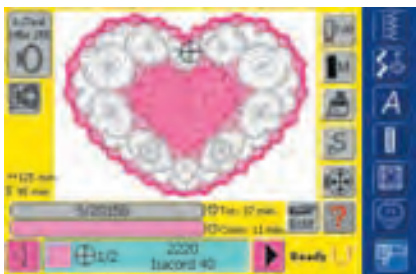

Embroidering Motif

To change to the Embroidery menu (Ready) touch «OK» in screen Edit 1 or press the external Quick Reverse button on head frame

- ❖ embroider motif

• for more information on Starting to Embroider see pages 204-205



TIP

Hoop Relocater

- this function makes threading easier when the needle is very close to the left edge of the hoop
- ❖ touch symbol and the hoop will move horizontally to the center, which makes threading easier



Positioning Motif

Positioning Motif in Desired Location

By moving or rotating the motif can be moved to another position within the hoop.

Preparation

- ❖ select desired motif from the Selection menu
- the motif appears in the screen Edit 1
- ❖ use the «To Next Page» symbol to change to the screen Edit 2

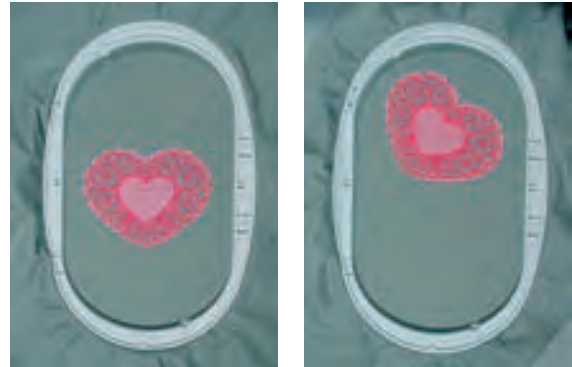

Move Motif

Move motif as desired:

- ❖ touch symbol
- the Information Areas for operating the stitch width and length knob appear
- ❖ to move the motif horizontally turn the stitch width knob
- ❖ turn stitch width knob to right to move motif to right
- ❖ turn stitch width knob to left to move motif to left
- in the Information Area the alteration is displayed in 1/10 mm
- ❖ to move the motif vertically turn the stitch length knob
- ❖ turn stitch length knob clockwise (down) to move motif downwards
- ❖ turn stitch length knob counter clockwise (up) to move motif up
- in the Information Area the alteration is displayed in 1/10 mm
- ❖ to move the motif diagonally turn the stitch width and length knob
- the motif is moved diagonally when the same number appears in both Information Areas
- ❖ to move the motif back to the middle touch the Information Areas or touch «Move Motif» again
- If a stitch happens to fall outside the embroidery area, the outline of the hoop is displayed in red.

Note:

If the knobs are turned slowly the motif can be moved step by step (step length = 1/10mm).



Rotate Motif

Rotate motif as desired:

- ❖ touch symbol
- the Information Area for operating the stitch width knob appears
- ❖ to rotate the motif clockwise turn stitch width knob clockwise
- in the Information Area the position is shown in degrees (°)
- ❖ to rotate the motif counter clockwise turn the stitch width knob counter clockwise
- in the Information Area the position is shown in degrees (°)
- ❖ to reactivate the default setting (0°/360°) touch the purple knob icon
- ❖ touch «rotate motif» several times and the motif is rotated clockwise in 90° steps (0°/90°/180°/270°/360°)

Note:

If the knobs are turned slowly the motif can be moved in 1° steps.



Checking the Motif Position

With the functions «Check» and «Motif Center» the motif position can be checked before embroidering.



Check

The function «Check» reads the attached hoop size and stitching area:

- ❖ touch symbol
- the hoop size is read causing the hoop to move
- ❖ «Check» then confirms placement by moving hoop to reflect stitching area of selected motif
- ❖ «Check» moves hoop 4 steps so that stitching area of selected motif can be confirmed
 - hoop moves to lower left corner
 - hoop moves to lower right corner
 - hoop moves to upper right corner
 - hoop moves to upper left corner
- ❖ confirm each position by touching «OK»
- if no hoop or a too small hoop was attached, an error message will appear



Checking Motif Center

- ❖ touch symbol
- the exact center of the motif is indicated on the display
- the hoop will be moved until the needle is in the center of the motif
- ❖ touch symbol again and on the display the first stitch of the motif will be marked once more



Altering Motifs

Mirroring Motifs

Each motif can be mirrored left/right or up/down.

Preparation

- ❖ select desired motif from the Selection menu
- motif appears in the screen Edit 1
- ❖ use the «To Next Page» symbol to change to the screen Edit 2



Mirroring Motifs Horizontally (left/right)

- ❖ touch symbol «Horizontal Mirror Image (left/right)»
- the motif will be mirrored horizontally



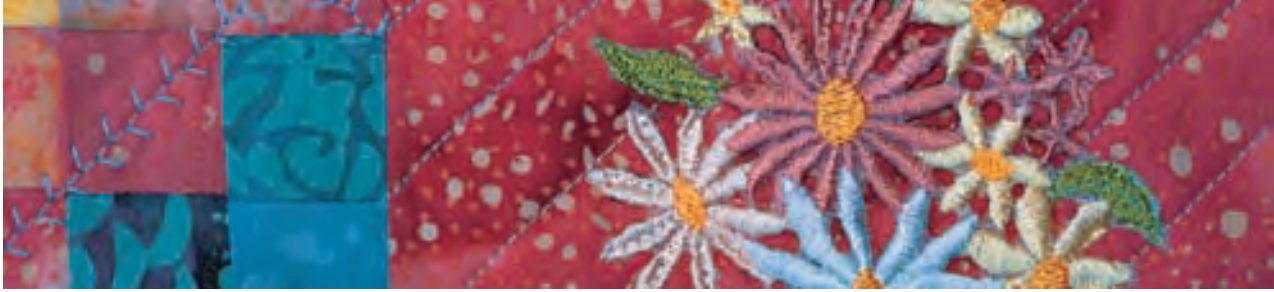

Mirroring Motifs Vertically (up/down)

- ❖ touch symbol «Vertical Mirror Image (up/down)»
- the motif will be mirrored vertically



Mirroring Motifs Horizontally and Vertically

- ❖ touch symbols «Horizontal Mirror Image (left/right)» and «Vertical Mirror Image (up/down)»
- the motif will be mirrored horizontally and vertically



Calculating New Embroidery Data

- I** After changing from screen Edit 2 to Embroidery menu (Ready)
- ❖ touch Recalculation to have best Quality - may be time consuming!
 - ❖ touch Resizing for fastest calculation. Quality may be not the best (only suitable for motifs which were altered between 90% and 120%).
 - the spinning thread spool indicates that an altered motif is being recalculated. At the same time the motif is being saved for recovery if necessary
 - depending on the size of the pattern, the saving might take a while
 - each alteration made will appear in the Embroidery menu (Ready)

Note:
No operations are possible during the calculation process!

TIP

Rotating mirrored motifs
A wonderful variety of combinations are possible together with the function «Rotate Motif».

TIP

Combining designs
If mirrored and unmirrored designs are combined, particularly attractive effects and borders can be designed.

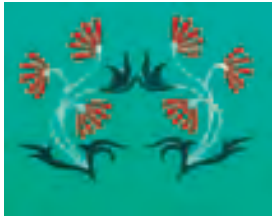

• for more information on Combining Motifs see pages 231-233

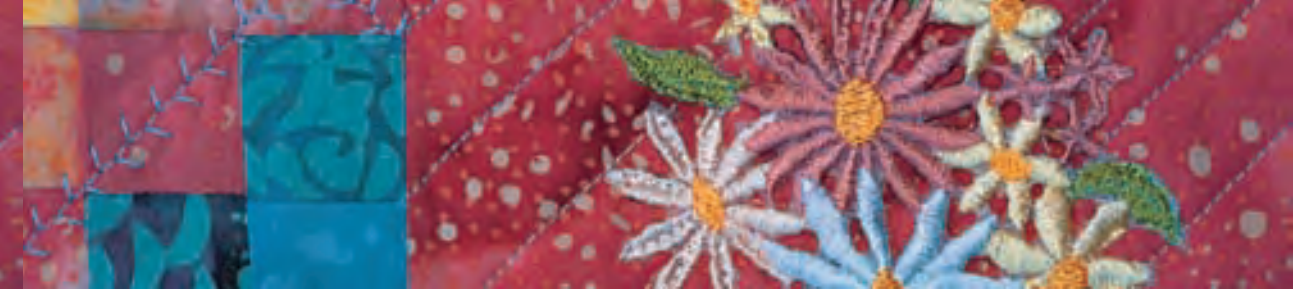

Altering Motif Size

Each motif can be proportionally enlarged or reduced as well as rescaled horizontally or vertically.

Preparation

- ❖ select desired motif from the Selection menu
- the motif appears in the screen Edit 1
- ❖ use the «To Next Page» symbol to change to the screen Edit 2

Note:

To get good results, the motifs should be scaled within the limits of 75% to 150%.



Enlarging or Reducing Motif Proportionally

Altering the motif as desired:

- ❖ touch symbol
 - the Information Area for operating the stitch width knob appears
- ❖ to enlarge the motif turn stitch width knob clockwise
- ❖ to reduce the motif turn stitch width knob counter clockwise
- in the Information Area the alteration is displayed in percent (%)
- ❖ to reactivate the default setting (100%) of the motif touch the Information Area

Note:

If the knobs are turned slowly the motif size can be altered in 1% steps.





Adjust the Motif Height or Width

Motifs can be widened or reduced horizontally or lengthened and reduced vertically as desired:

- ❖ touch symbol
 - the Information Areas for operating the stitch width and length knob appear
 - ❖ to adjust the width (widen or reduce the motif horizontally) turn stitch width knob clockwise to widen or counter clockwise to reduce motif
 - in the Information Area the adjustment is displayed in percent (%)
 - ❖ to adjust the height (lengthen or reduce the motif vertically) turn stitch length knob clockwise to enlarge or counter clockwise to reduce motif
- in the Information Area the adjustment is displayed in percent (%)
- ❖ to reactivate the default setting (100%) of the motif touch the Information Area



Note:
If the knobs are turned slowly the motif size can be altered in 1% steps.

Display of the Motif Size

↔ 139 mm
↓ 124 mm

The motif width and height is displayed in millimeters (mm) on screen.

Selecting the Most Appropriate Hoop for Adjusted Motif Size



The most appropriate hoop should be chosen for the motif size:

- ❖ touch «Select Hoop»
- a special screen appears with possible choices of hoops
- by selecting a hoop (Small, Middle, Large Oval or Mega) the motif is shown in the appropriate hoop after the special screen closes

Calculating New Embroidery Data

After changing from the screen Edit 2 to Embroidery menu (Ready) the new embroidery data is recalculated according to the changes made.

- for more information on Calculating New Embroidery Data see page 228

Combining Motifs

Motifs can be combined as desired with the embroidery computer to create completely new designs. A combination can consist of several identical motifs or of different ones. It is also possible to combine motifs with lettering.

Application

- combining motif variations
- creating new designs
- embroidering borders
- creating logos, crests, badges, labels, etc.

Preparation

- ❖ select desired motif from the Selection menu
- the motif appears in the screen Edit 1



Creating Combinations



Adding Another Motif

With the function «Add Motif» another motif or letter from the Selection menu is added to the existing one:

- ❖ touch «Add Motif»
- Selection menu appears
- ❖ select motif or letter of your choice from the Selection menu



- for more information on Lettering see pages 234-239



Duplicating Existing Motif

The duplicating function simplifies combining different variations of the same motif:

- ❖ touch «Duplicate»
- the active motif will be duplicated automatically and displayed slightly offset above the other motif



Note:

Moving motifs in multiple combinations may result in a delay of on-screen information.



Creating Motif Combination

With functions such as «Move Motif», «Rotate Motif» «Mirror Image», etc. the motif combination can be created as desired.



Selecting Motif Within the Motif Combination

- ❖ touch the symbol «Retrieve» once or more
- switches between different motifs when combining designs
- active motif is shown in color
- ❖ touch «Retrieve» until the desired motif is activated

Note:
Depending on how many times the symbol was touched, one motif or the complete motif combination is active.



Creating / Altering Motif Combination

- ❖ use the «To Next Page» symbol to change to the screen Edit 2 and create combination by altering the active motif (= in color):
- ❖ with «Move Motif» move the motif to the desired position
- in addition other alterations are possible: scaling, rotating, mirroring, etc.

• for more information on different Functions see pages 206-213

- the screen displays all changes directly
- ❖ to alter another motif of the motif combination, activate the desired motif with «Retrieve»
- ❖ alter selected motif as desired



Note:
With the function «Move Motif» (touch twice) a duplicated motif can be centered.



Note:
If the indicated hoop offers too little space, select a larger one with the function «Select Hoop».



Corrections and Alterations in the Motif Combination

Inserting New Motif

- to add another motif or duplicate an existing motif see «Creating Combinations»

Altering Motif

- ❖ touch the symbol «Retrieve» in the screen Edit 1 or Edit 2 once or more until the desired motif is activated (in color)
- ❖ alter the activated motif in the screen Edit 2 as desired



Deleting Motifs

- ❖ touch the symbol «Retrieve» in the screen Edit 1 or Edit 2 once or more until the desired motif is activated (in color)
- ❖ touch «Delete» in the screen Edit 1 and the activated motif will be automatically deleted

Selecting the Most Appropriate Hoop for Adjusted Motif Size

The best embroidery results are achieved by selecting the most appropriate hoop for the motif size.

- for more information on Selecting the Most Appropriate Hoop see pages 204/207 ●●●●●●●●

Calculating New Embroidery Data

After changing from the screen Edit 1 or Edit 2 to Embroidery menu (Ready) the new embroidery data is recalculated according to the changes made.

- for more information on Calculating New Embroidery Data see page 228 ●●●●●●●●●●

- for more information on Saving Motifs see pages 248-250 ●●●●●●●●



Letters can be combined with other letters or motifs and embroidered with the embroidery computer. The artista 730 embroidery computer's screen Edit 2 offers a large variety of alteration possibilities:

Apart from altering the letter size, the baseline type amongst other things, can be altered. For instance arched letters can be made from horizontally arranged letters.

Application

- names, monograms and addresses
- words and text
- creating logos, crests, badges, labels, etc.
- labeling quilts (quilt labels)



Alphabets - Lettering



Combining Letters

- ❖ select desired alphabet from the Selection menu
 - a special screen with a keyboard appears
 - the «ABC» on-screen button (upper case) is automatically active
 - in the special screen there are different functions which take you to the appropriate lettering:
 - «Capital Letters» function
 - «Lower Case Letters» function
 - «Special Capital Letters» function
 - «Special Lower Case Letters» function
 - «Numbers» function
 - «Special Characters» function
- ❖ select desired letters
- ❖ spaces can be added by touching the blank space bar
- the letters appear in the Text bar

Note:

If your edited lettering does not fit in the hoop, rotate lettering by 90° (a large number of letters can fit into the lengthwise stitch area of the hoop).

Should this not be of any help then change size of lettering or reduce number.

Correcting Letters

- ❖ to delete individual letters touch the arrow on the right of the Text bar
- letters are deleted from right to left
- ❖ to delete letters touch the Text bar

Confirming Letters

- ❖ confirm combined letters with «OK» and the letters appear in the screen Edit 1

Embroidering Letters With or Without Alterations

The combined letters are ready to be embroidered or can be altered with the different functions as desired.

- for more information on Embroidering With no Alterations see pages 204-205 (Basic Information on Embroidering Motifs With no Alterations)

Altering Lettering



The letters are altered in the screen Edit 2:



Rescaling the Letters Height or Width

- ❖ touch symbol and the Information Areas for operating the stitch width and length knob appear
- ❖ to adjust the motif horizontally turn stitch width knob
- ❖ to adjust the motif vertically turn stitch length knob
- in the Information Area the adjustment is displayed in percent
- ❖ to reactivate the default setting (100%) of the motif touch the Information Area



Mirroring Lettering

- ❖ touch symbol «Horizontal Mirror Image (left/right)» and the motif will be mirrored horizontally
- ❖ touch symbol «Vertical Mirror Image (up/down)» and the motif will be mirrored vertically

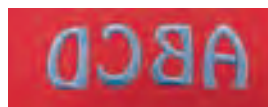

Enlarging or Reducing Lettering Proportionally

- ❖ touch symbol and the Information Area for operating the stitch width knob appears
- ❖ to enlarge the motif turn stitch width knob clockwise
- ❖ to reduce the motif turn stitch width knob counter clockwise
- in the Information Area the alteration is displayed in percent
- ❖ to reactivate the default setting (100%) of the motif touch the Information Area



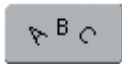
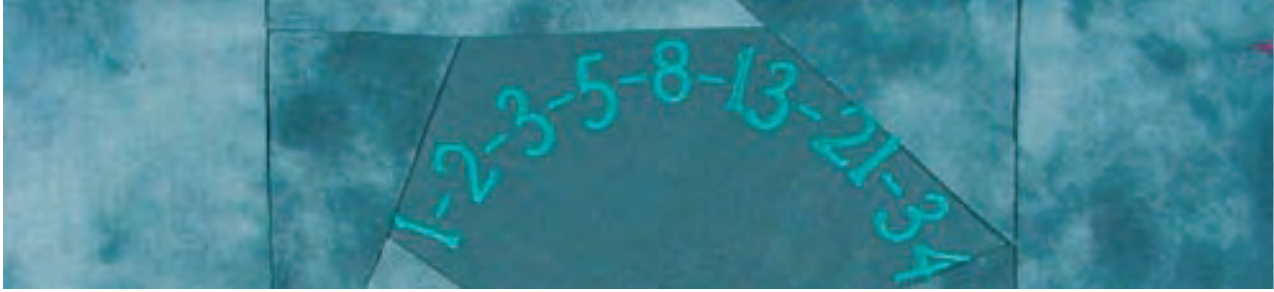

Creating Arched Lettering

- ❖ touch symbol and a special screen appears
- ❖ select desired arched lettering style:
 - lettering below the curved baseline (lettering counter clockwise)
 - lettering above the curved baseline (lettering clockwise)
 - three forms each of arched lettering are possible (the larger the green circle the less the arch)
- ❖ confirm with «OK»
- the special screen closes and the lettering is displayed, formed in the selected arch



Lettering With Vertical or Horizontal Baseline

- ❖ touch symbol and a special screen appears
- ❖ select vertical or horizontal baseline
- ❖ confirm with «OK»
- the special screen closes and the lettering is displayed, formed in the selected baseline



Moving Letters

- after altering the baseline it is possible that the programmed text is no longer in the center of the hoop
- ❖ touch symbol twice to move text to the center of the hoop



Altering Lettering Size With Direct Input

- ❖ touch the Letter Manipulation button
- ❖ height can be changed in mm steps for selected lettering by using arrows at right end of Height box
 - up arrow increases lettering size
 - down arrow decreases lettering size



Changing Letter Spacing

- ❖ use up or down arrows to change spaces in mm steps between letters



Changing Fonts

- ❖ touch the Letter Manipulation button
- ❖ new font can be selected for entered text
- ❖ use up or down arrows at right end of Font bar to change font style

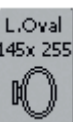

Selecting the Most Appropriate Hoop for Adjusted Motif Size

The best embroidery results are achieved by selecting the most appropriate hoop for the motif size.

- for more information on Selecting the Most Appropriate Hoop see pages 204/207



Calculating New Embroidery Data

After changing from the screen Edit 2 to Embroidery menu (Ready) the new embroidery data is recalculated according to the changes made.

- for more information on Calculating New Embroidery Data see page 228

- for more information on Saving Altered Lettering see pages 248-250

Combining Lettering

Letters (for example words) can be combined with other letters or motifs.

Combining Different Words

The words (for example Nothing Sews Like A Bernina. Nothing.) are put together by the line and positioned individually:

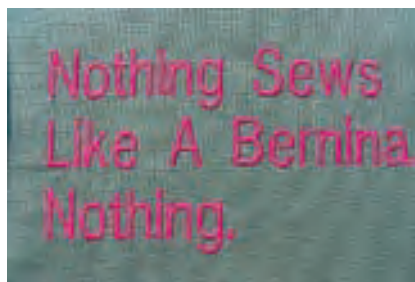

Putting Together the First Text Line

- ❖ select desired alphabet type from the Selection menu
 - a special screen with a keyboard appears
- ❖ enter for example «Nothing Sews»
 - select letters by using the Upper Case/Lower Case button and touch space bar to insert spaces where needed
- ❖ confirm combined letters with «OK» and the letters appear in the screen Edit 1
- ❖ use the «To Next Page» symbol to change to the screen Edit 2

Note:
Moving motifs in multiple combinations may result in a delay of on-screen information.



Positioning First Text Line

- ❖ select large hoop (Large Oval) with the function «Hoop Select»
- ❖ rotate text by 90° (more space for text in hoop) with the Rotate Motif function
- ❖ position text with the function «Move Motif»
- ❖ if a stitch happens to be placed outside the embroidery area, the motif outline is displayed in red



Combining and Positioning Further Text Lines

- ❖ select «Add Motif» in the screen Edit 1
 - further text lines will also be combined and positioned individually as described above
- ❖ for even line spacings: align lines with the help of the values displayed in the «Move Motif» function and switch guiding lines function on



Combining Motifs and Lettering

After selecting a motif the lettering is added according to the work at hand (e.g. text in a motif). Or the lettering is created first and the motif added afterwards (e.g. embellished text).



Combining Example

- ❖ select desired motif in the embroidery computer
 - the motif appears in the screen Edit 1
- ❖ select «Add Motif» in the screen Edit 1
- ❖ select desired alphabet type from the Selection menu
 - a special screen with keyboard appears
- ❖ enter text (e.g. «Flowers»)
- ❖ select lettering using Upper Case/Lower Case button
- ❖ confirm combined lettering with «OK» and the lettering is displayed in the screen Edit 1 slightly offset above the motif



Note:
Moving motifs in multiple combinations may result in a delay of on-screen information.



Altering Text to Suit Motif

- ❖ use the «To Next Page» symbol to change to the screen Edit 2
- ❖ position the text as desired with the function «Move Motif»
- ❖ alter text size to suit motif with the functions «Rescale Motif Proportionally» or «Rescale Motif Height or Width»

Calculating New Embroidery Data

After changing from the screen Edit 2 to Embroidery menu (Ready) the new embroidery data is recalculated according to the changes made.



• for more information on Saving Lettering see pages 248-250

• for more information on Calculating New Embroidery Data see page 228

Motif Colors

The motif colors can be changed as well as embroidered in different ways.

Preparation

- ❖ select desired motif from the Selection menu
- the motif is displayed in the screen Edit 1



Adjustments

Reallocating Motif Colors



- ❖ touch the function «Color Number» in the screen Edit 1 or Edit 2
- the Color Motif display opens
- following information on color is available: display of current color, current color position (first number), number of all colors (second number) and color number of chosen thread brand
- ❖ scroll with the arrows until the color to be changed appears
- ❖ touch Color Information bar



- a special screen for changing the current thread color appears
- ❖ to change the thread brand scroll with the arrows next to the color brand, until the desired brand appears
- ❖ to change the thread color scroll with the arrows next to the thread color, until the desired color appears, then touch Color bar
- touched Color bar is active (highlighted in blue)



Note:
For a quick selection of a certain color number, use the function «Color Selection by Number».

- ❖ touch «OK» , selected thread color and changed thread brand are displayed in the Color Information bar



Embroidering Motifs in One Color



- ❖ touch the brush symbol in the Embroidery menu (Ready)
- brush symbol is activated (highlighted in blue)
- embroidery computer stops only when motif is complete



Embroidering Lettering in Multi Colors



- lettering is embroidered in one color and the brush symbol is not visible
- to embroider each letter of a word or each word of a word combination in a different color, each letter or word must be programmed and placed separately
- the embroidery computer stops after each letter or word, the thread color can be changed
- the Embroidery Time is displayed for each color
- to embroider the complete lettering combination in one color, touch the brush symbol now visible

• for more information on Combining Motifs see page 231 ●●●●●●

Embroidering Individual Color Sections and Manual Adjustment of Color Sequence



- special effects can be acquired according to the motif, only when individual color sections are embroidered (e.g. embroider only the outlines of the motif)
- ❖ scroll Embroidery menu (Ready) for color sequence until desired color area is displayed
- ❖ to confirm touch the Color Information bar (the cursor symbol appears). This positions the needle in the start of the color sequence selected
- ❖ embroider color (embroidery computer stops automatically at the end of color)

Adjusting Motifs



Special fabrics (e.g. toweling, velvet, etc.), thinner or thicker threads can influence the embroidery result. If the embroidery test is not satisfactory, the motif can be adjusted accordingly with the Motif Properties function in the screen Edit 2:

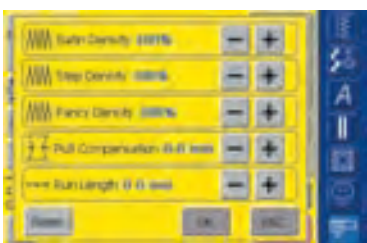

- ❖ touch Motif Properties function
- a special screen with the following functions appears:
 - Satin Density: altering stitch density of satin stitch
 - Step Density: altering stitch density of step stitch
 - Fancy Density: altering stitch density of Fancy-Fill
 - Pull Compensation: adjusting excessive spacing/overlap of motif
 - Run Length: altering outline length

Altering Stitch Density



- ❖ determining stitch type: satin stitch, step stitch or decorative stitches (Fancy-Fill)
- ❖ increase desired stitch density by touching «+»
- ❖ reduce desired stitch density by touching «-»
- ❖ confirm entry by touching «OK»
- the spinning spool shows that the new motif is being recalculated
- the spinning spool disappears and the screen Edit 2 reappears

• for more information on Stitch Types see pages 216-217 ●●●●●●

Adjusting Pull Compensation



- is used for example when the outline is not correct or the motif is distorted
- ❖ touching «+» increases the Pull Compensation value to decrease excessive spacing between objects and/or outlines caused by the push and pull effect of fill stitches
- ❖ touching «-» decreases the Pull Compensation value to eliminate excessive overlap of objects and/or outlines caused by the push and pull effect of fill stitches
- ❖ confirm entry by touching «OK»
- the spinning spool shows that the new motif is being recalculated
- the spinning spool disappears and the screen Edit 2 reappears



Altering Run Length (Outline)

- ❖ lengthen Run Length by touching «+»
- ❖ shorten Run Length by touching «-»
- ❖ confirm entry by touching «OK»
- the spinning spool shows that the new motif is being recalculated
- the spinning spool disappears and the screen Edit 2 reappears

Free Arm Embroidery



Free arm embroidery is suitable for lettering and small motifs (not larger than 72x50mm).

Application

- embroidering closed items such as sleeves, trousers, socks, etc.
- embroidering tubular items



- for more information on Attaching Adapter see page 200

Preparation

- ❖ insert the adapter between the sewing computer and the embroidery module

Applications

Selecting Motif

- ❖ select motif, stitching field of small hoop is 72x50 mm
- ❖ rescale motif if necessary
- ❖ check motif size with the function «?» (Help) from the Selection menu if necessary



Note:

Not only small motifs are suitable for free arm embroidery, but also lettering and letter combinations.



- ❖ select motif or letter
- the desired motif is displayed in the small hoop in the screen Edit 1
- ❖ alter motif or lettering if desired
- ❖ when altering pay attention that maximum size does not exceed 72x50 mm

Embroidering

- ❖ when changing from the screen Edit 1 or Edit 2 to Embroidery menu (Ready) the «adapter recognition» takes place
- the embroidery computer recognizes that the adapter as well as the small hoop are attached
- ❖ embroider motif

Embroidering Lace



- lace motifs can be embroidered directly onto fabric. For a true lace effect, however, embroider the motif on water soluble stabilizer, and then use it as lace
- use fine thread for fine embroidery. Use thick thread for crochet style effects



Embroidering

- ❖ place two or three layers of water soluble stabilizer in embroidery hoop (depending on thickness of stabilizer)
- ❖ embroider motif
- ❖ rinse stabilizer away and place lace flat on paper towels to dry

Note:
In the two lace motifs already programmed in the embroidery computer, only the Heart is suitable for the technique described above.

TIP

For lace motifs (e.g. Lace Border) place a piece of organza, netting or tulle underneath water soluble stabilizer when using one layer, and in between when using two layers. Trim excess organza or tulle closely along motif after rinsing and drying.



Embroidering Borders

- embroidered borders can be made either from several small motifs or from long rows of aligned motifs
- borders are perfect for decorative embellishment of table and bedlinen, drapery and skirt hems, etc.

Preparation

- ❖ use basting stitch (stitch No. 21) on sewing computer or an air or water soluble marker (test first on fabric remnant) to mark the center of the border
- ❖ sub-divide border: measure length of the whole border as well as of one single motif or repeat (the size of one motif is displayed on the embroidery computer)
- ❖ divide the whole length of border by the length of one motif or repeat to get the number of motifs or repeats that can be stitched on the border
- the remaining length is the distance between the individual motifs (divide length by one motif less than calculated, e.g. 8 motifs or repeats: divide total length by 7)
- for a wider distance between the individual motifs, stitch fewer motifs
- ❖ mark individual motif center
- in continuous motifs, the end point of one motif is often the start point of the next one, so the positioning of the individual motifs is done automatically

Embroidering

- ❖ use template to place fabric in hoop (use center point and marked center line as a guide)
- ❖ embroider motif, unhoop fabric and rehoop at next mark



TIP

Positioning motifs

Use BERNINA's software to print motif in original size for use as a template. Use print to arrange and place motif directly on fabric (mark center or start point of design).

Alternatively, use a scrap of original fabric to embroider motif. Use motif instead of print for placements.

TIP

Checking first stitch before completing embroidery

Touch the Color Information bar in Embroidery menu (Ready) to move the hoop to first stitch of current thread color (a cursor symbol appears in the Color Information bar).

TIP

Embroidery Mega-Hoop (special accessory)

Use the embroidery Mega-Hoop for particularly easy embroidering of borders: fabric need not be hooped as often as when using normal hoops.

Shadow Embroidery



A shadow effect is acquired if the same embroidered lettering or word in another color is placed slightly offset on top of an already embroidered lettering or word.



Creating Lettering

- ❖ create lettering

- for more information on Lettering see page 234

Reducing Stitch Density

- since the lettering is embroidered on top of each other, reduce the stitch density to obtain best possible embroidery results
- ❖ select Motif Properties function in the screen Edit 2
- a special screen with stitch types altering applications appears
- ❖ reduce stitch density of lettering stitch by touching «-» and confirm with «OK»
- according to the amount of reduction, embroidered lettering appears more airy

Duplicating Lettering

- ❖ copy lettering with the function «Duplicate» in the screen Edit 1
- the alteration of the stitch density remains in the lettering copy



Moving Copied Lettering

- ❖ move lettering copy to the desired position in the screen Edit2
- the created lettering shadow can appear smaller or larger according to how the copied lettering was moved



Allocating Motif Colors

- ❖ allocate the desired lettering colors in the screen Edit 1 or Edit 2

- for more information on Allocating Motif Colors see page 240

Embroidering Lettering With Shadow

- ❖ embroider lettering

TIP

For good embroidery results

Reduce embroidery speed according to stitch density if necessary.

Saving Motifs 248

- Saving to the embroidery computer
 - Saving on Personal design card
 - Overwriting motifs
- Saving on BERNINA Memory Stick

Deleting Saved Motifs 251

- Deleting one saved motif
- Deleting all saved motifs

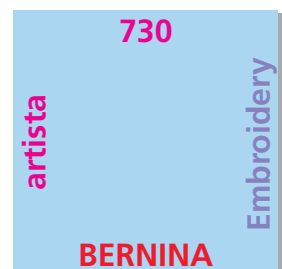
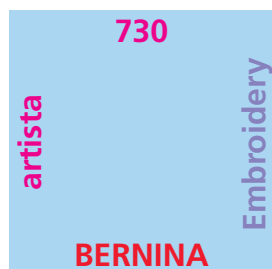
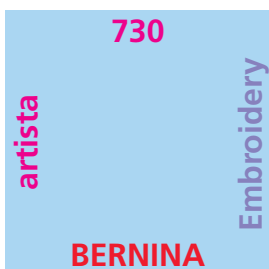
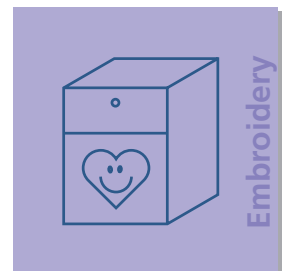
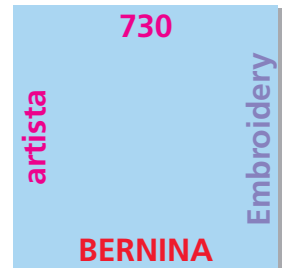
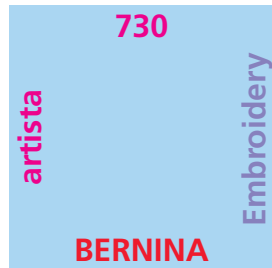
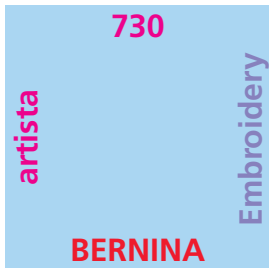

Saving and Deleting Motifs

In General

Motifs from the embroidery computer, personal design cards, Sticks or the myartista Portal, as well as motifs created in the BERNINA artista software, can be combined, rearranged, and altered in different ways, then saved. Motifs can either be saved to the embroidery computer, on a personal design card or on a Personal USB Memory Stick.

The embroidery computer has a memory system, i.e. both the sewing stitch combinations and embroidery «My Designs» are saved in this system. Since the memory space is not sub-divided into fixed spaces, any desired number of motifs can be stored as long as enough free memory is still available. If there is not enough memory space, other motifs and/or stitch information must first be deleted.



Saving Motifs

Saving to the Embroidery Computer

Note:

In a saved stitch combination, individual stitches can be altered after being selected.

Note:

Motifs which have been altered in terms of size, stitch density, etc. and saved, will be regarded as a new motif when subsequently selected and placed in the center of the hoop. That is why all percentages say 100%, and the original alteration(s) is/are no longer visible.



- ❖ open desired motif from embroidery computer, personal design card or peripheral source
- ❖ alter or combine motif if desired
- ❖ touch «Save» in the screen Edit 1

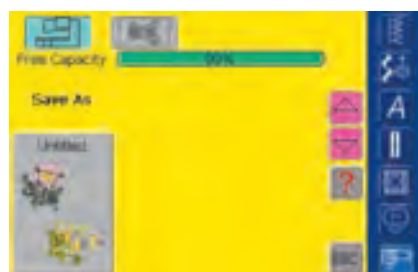

- motif to be saved is displayed as «untitled» on left of screen
- the Embroidery Computer button from the Selection menu is activated
- the folder My Designs will open automatically
- the System Memory Capacity (Free Capacity) is shown in percentage (%) in a bar above the folders
- ❖ select motif to be saved



- screen with keyboard appears
- ❖ name the motif folder
- ❖ touch «OK»
- the motif is now saved under this name in the My Designs folder (in alphabetical order)

Saving to a Personal Design Card



- personal design cards are available as optional accessories from your BERNINA dealer
- ❖ open desired motif from embroidery computer, personal design card or peripheral source
- ❖ alter or combine motif if desired
- ❖ touch «Save» in the screen Edit 1



• for more information on Embroidery Cards see page 263



- motif to be saved is displayed as «untitled» on left side of screen
- ❖ insert personal design card
- ❖ select Design Card button from the Selection menu
- ❖ the System Memory Capacity (Free Capacity) is shown in percentage (%) in a bar above the folders
- ❖ select the motif to be saved



- screen with keyboard appears
- ❖ enter name of motif
- ❖ touch «OK»
- motif is now saved on personal design card in alphabetical order with this name

Saving to a Memory Stick (BERNINA Personal Memory Stick)



- blank memory sticks are available as optional accessories from your BERNINA dealer
- ❖ select motif from the embroidery computer, an embroidery card or other data storage devices
- ❖ edit or combine motif if wished
- ❖ press «Save» in Edit 1 screen



- the motif to be saved is displayed as «Untitled» on the left in the screen
- ❖ connect memory stick
- ❖ select «USB Stick»
- A green bar above the designs shows the used memory as percentage
- ❖ chose the design to be saved



- key pad screen opens
- ❖ enter name of motif
- ❖ press «OK»
- motif is now saved under the given name in alphabetical order on memory stick

Overwriting Motifs



- motifs saved in «My Designs», on a personal design card or on a personal USB memory stick can be directly overwritten with a new motif
- ❖ open desired motif from embroidery computer, personal design card or peripheral source
- ❖ alter or combine motif if desired
- ❖ touch «Save» in the Design Menu Edit 1



- motif to be saved is displayed as «untitled» on left of screen
- ❖ select «Memory Card» (if memory card is inserted) or «USB Stick» (if memory stick is connected) or «Embroidery Computer» in the Selection menu
- ❖ touch the motif you wish to overwrite

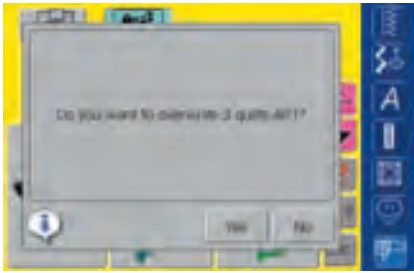

- a message appears asking «Do you want to overwrite 3 quilts.ART?»
- ❖ touch «Yes» to confirm
- ❖ select the motif to be saved
- ❖ the motif is now saved with the name of the overwritten one

Deleting a Saved Motif



- ❖ in the Selection menu, select «Memory Card» (if memory card is inserted) or «USB Stick» (if memory stick is connected) or «Embroidery Computer» and respective file
- ❖ touch the «?» (Help) button in the motif overview
- ❖ select appropriate motif



Deleting Saved Motifs



- a special screen opens which, in addition to information on the motif selected, displays the Delete button at the bottom left
- ❖ touch «Delete»



- special screen opens
- ❖ touch «I want to delete this design»
- message «Do you really want to delete this design?» appears
- ❖ confirm with «Yes»
- motif is deleted

Note:

If stock embroidery designs that came with the sewing computer are deleted, use the enclosed USB data stick to reload them to the sewing computer.

Deleting All Saved Motifs

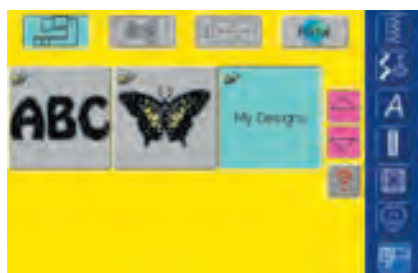

- it is possible to delete the content of a personal design card, of a personal USB memory stick or a folder that has been saved on the embroidery computer all at once
 - ❖ to delete the content of a personal design card, activate Design Card (personal design card inserted) in the menu
 - ❖ select «USB stick» (if a memory stick is connected) in the main menu to delete the contents of a memory stick
 - ❖ to delete the content of a folder in the embroidery computer, select Embroidery Computer in the menu, then the appropriate folder (Alphabets, Motif, My Designs)



- ❖ touch the «?» (Help) button
- ❖ select any desired motif



- a special screen opens which, in addition to information on the motif selected, displays the Delete button at the bottom left
- ❖ touch «Delete»



- special screen opens
- ❖ touch «I want to delete ALL designs»



- message «Do you really want to delete all designs in the folder/personal design card?» appears
- ❖ confirm with «Yes»
- all motifs which were in the appropriate folder, on the personal design card or on the personal USB memory stick are now deleted

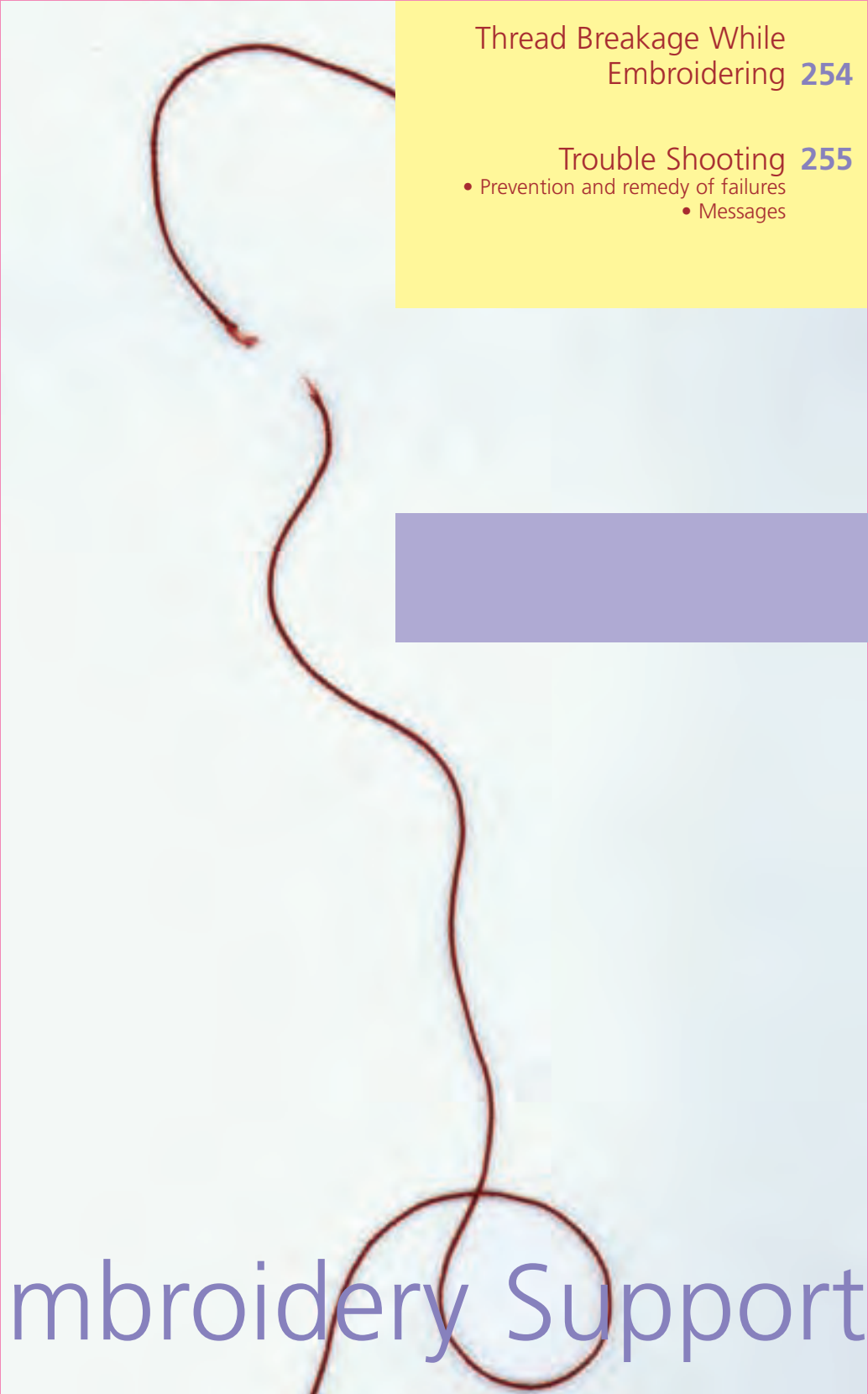

Thread Breakage While
Embroidering **254**

Trouble Shooting **255**

- Prevention and remedy of failures
- Messages



Embroidery Support

It is possible that the upper or lower thread may run out or break while embroidering. In this case the embroidery computer stops automatically provided that the upper and lower thread sensors are activated.

- how to activate Upper and Lower Thread Sensors in Setup see page 172



Upper Thread Breaks

- the embroidery computer stops automatically when the upper thread runs out or has broken
- a message appears on the screen
- ❖ check upper thread and lower thread if necessary and rethread
- ❖ touch «OK» to go back to the Embroidery screen

Thread Breakage While Embroidering

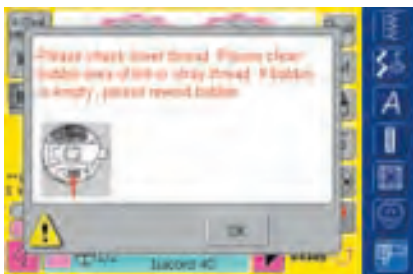

Lower Thread Runs Out

- the embroidery computer stops automatically when the lower thread runs out
- a message appears on the screen
- ❖ check lower thread and refill if necessary
- ❖ touch «OK» to go back to the Embroidery screen



Embroidery Sequence Control for Thread Breakage

- ❖ touch symbol «Embroidery Sequence Control»
- the motif is enlarged for a better view of the exact place of the thread breakage
- an Information Area for the use of the stitch width knob appears
- ❖ turn the stitch width knob counter clockwise (or clockwise) to move the embroidery hoop backwards (or forwards) in the embroidery sequence
- ❖ turn the stitch width knob slowly to move the hoop stitch by stitch
- ❖ go back stitch by stitch to a position several stitches before thread breakage occurred to resume stitching



Resuming Embroidery

- ❖ press foot control or Quick Reverse button on head frame to resume stitching
- Embroidery screen reappears again
- ❖ complete motif

Prevention and Remedy of Failures

Note the following advice to recognize the causes of most of the operation failures in the embroidery computer that might occur.

Check First Whether:

- upper and lower threads are threaded correctly
- the needle is inserted correctly - flat part of the shank to the back
- the needle is the correct size (see Needle/Thread Chart on pages 17-19)
- the embroidery computer is clean - remove any thread lint
- the hook race is clean
- bits of thread are trapped between the tension disks and under the bobbin case spring

Removing Trapped Thread

If the lower thread breaks and the thread is trapped in the area of the take-up lever, proceed as follows:

- power switch to «0» (off)
- remove the screw on the head frame with the angular Torx key
- pull head frame to the left
- remove remnants of thread
- attach head frame and tighten screw

Upper Thread Breaks

Possible Faults:

- upper thread tension is too tight
- use of low quality needle. It is best to buy needles in a BERNINA store
- needle has been inserted incorrectly. The flat part of the shank must be to the back
- needle is blunt or bent
- use of poor quality thread, thread with knots, thread too old or dried out

Possible Solutions:

- attach foam pad
- use appropriate spool disc
- use net for even unwinding of thread (pull over upper thread spool)
- stitch plate hole or hook tip is damaged: take the embroidery computer to an authorized BERNINA dealer
- reduce embroidery speed

Lower Thread Breaks

- lower thread tension is too tight
- lower thread is trapped in the bobbin case:
 - Replace bobbin
- needle is blunt or bent
- the stitch plate hole has been damaged by the needle:
 - It must be polished by a BERNINA Technician

Skipped Stitches

- incorrect needle used

- Use only 130/705H needle system
- Needle is bent or blunt
- Needle is not correctly inserted
- Push all the way to the top when inserting
- low quality, badly polished needle used

Needle Breaks

- needle clamp screw is too loose
- defective stitch plate

Unsatisfactory Stitch Formation

- remnants of thread between tension disks:
- pull folded thin fabric (use the fold, not an outer edge) back and forth between the tension disks to clean the left and right side of the thread tension

Trouble Shooting



- remove any remnants of thread from under the bobbin case spring
- adjust thread tension
- used wrong or no stabilizer at all
- incorrectly threaded;
 - check upper and lower thread
- when embroidering, thread pigtail tensioner with lower thread
- use appropriate spool disc
- clean and oil hook (use original oiler only. See Cleaning and Lubricating on page 185)

Embroidery Computer Fails to Run or Runs Slowly

- plug not fully inserted
- power switch in «0» (off) position
- embroidery computer requires normal room temperature for operation

Defective Sewing Light

- take the embroidery computer to an authorized BERNINA dealer

Lower Thread Indicator Sensor

- bobbin cover is not closed
- not activated in the Setup Program
- remove any thread lint and remnants from the bobbin case

Upper Thread Indicator Sensor

- not activated in the Setup Program

Messages

In special cases messages may appear on the screen. They serve as a reminder, warning, or confirmation of selected applications and functions.

• Possible Messages regarding the sewing computer see page 189 ●●●●●●●●

Below, the embroidery module messages are listed.

Message

- The embroidery computer cannot change to sewing. Please finish the layer and press the «Edit» button to return to previous screen. You may now safely change to sewing.
- Hoop cannot be parked because the presser foot or needle is in the wrong position.
- Please lower the feed dog.
- Please use a larger embroidery hoop.
- Card exchange was not accepted. Possible loss of data! Please refer to your manual before exchanging cards.
- The point lies outside the embroidery area.
- The next stitch lies outside the embroidery area. Please rehoop fabric and relocate the design.
- Please reposition the Mega-Hoop to Upper (1) position, raise presser foot and press OK to start calibration.
- Please reposition the Mega-Hoop to Middle (2) position, raise presser foot and press OK to start calibration.
- Please reposition the Mega-Hoop to Lower (3) position, raise presser foot and press OK to start calibration.
- Please change the needle to the highest position.
- Please attach embroidery module.
- Embroidery module communication NOT working!
- Embroidery design card NOT working.

Note

- It is not possible to switch from Embroidery Menu (Ready) to Sewing mode. Press «Edit» to return to Edit screen first.
- Check presser foot and needle position.
- Press the feed-dog drop key. The message disappears automatically when the feed-dog position was changed.
- The embroidery design does not fit into the attached hoop.
- Do not remove embroidery card from embroidery computer when in process.
- Reposition design to fit into embroidery area before starting to stitch.
- Follow the instructions in the message.
- Move Mega-Hoop to position 1 (top).
- Move Mega-Hoop to position 2 (center).
- Move Mega-Hoop to position 3 (bottom).
- Place needle into highest position by hand.
- The embroidery module must be attached.
- Check embroidery module/embroidery computer connection.
- Remove embroidery card and insert again. Try other card if necessary.



Message

- You have selected embroidery. Please attach the embroidery module and foot No. 26 or No. 15, lift the presser foot and lower the feed dog. Please remove hoop (if attached). Press OK to start module detection, the Module Arm will MOVE.
- The attached hoop is too small for this design. Please press ‚Edit‘ button to return to previous screen, change hoop and press ‚OK‘ for hoop detection.
- You have changed the hoop attachment. (from ‚normal‘ to ‚free-arm‘ or vice-versa) Please press ‚check‘ button to start module calibration
- ADX: Please switch to Embroidery Mode to stitch out the file.
- Not enough free Space to save Design!
- Design does not fit into hoop!
- Bottom Left Position lies outside of hoop!
- Bottom Right Position lies outside of hoop!
- Top Right Position lies outside of hoop!
- Top Left Position lies outside of hoop!
- Design Successfully Finished.
- Please check the upper and lower thread for thread breakage or empty bobbin.
- Please check lower thread. Please clean bobbin area of lint or stray thread. If bobbin is empty, please rewind bobbin.
- Please lower presser foot.
- Please raise the presser foot.
- For easier threading it is recommended that the presser foot is lowered.
- The sewing/embroidery computer is not functioning correctly. Please contact your BERNINA dealer.
- During start-up an error occurred. Please restart the sewing/embroidery computer. If the problem persists please contact your BERNINA dealer.
- The BERNINA Modem cannot be identified. Please insert the Modem and try again.

Note

- Follow the instructions in the message.
- Follow the instructions in the message.
- Embroidery designs can only be stitched in Embroidery mode.
- Embroidery designs can only be stitched in Embroidery mode.
- Scale design down or use larger hoop.
- Scale design down or use larger hoop.
- Position design within hoop.
- Position design within hoop.
- Position design within hoop.
- Unhoop fabric.
- Unhoop fabric.
- Check the upper thread and lower thread if necessary.
- Follow the instructions in the message.
- The message will automatically disappear when the presser foot is lowered.
- The message will automatically disappear when the presser foot is raised.
- Lower the presser foot
- Contact your BERNINA dealer ato check on the problem.
- Switch sewing/embroidery computer off and on again..
- The modem has not been recognized. Remove modem and reconnect.



Message

- Cannot dial, please check the phone line and then dial number.
- The authentication for the provider failed. Please check the username and the password.
- The communication with the provider was interrupted. Please try later or use another provider.
- An unknown error occurred with the Modem. Please try again.
- You cannot save or delete files on the myartista Portal.
- A problem occurred in communicating with the myartista Portal. Please try again.
- Your sewing/embroidery computer has now reached the time limit, where in order to guarantee continuous satisfactory work, the following small tasks should be carried out. Remove thread and lint and remnants from beneath the stitch plate, as well as from the feed dog area. These instructions can be found on page 185 of the manual.
- Your sewing/embroidery computer has now reached the time limit, where your BERNINA dealer will be pleased to give it a service check.
- You have opted for the possibility not to take your sewing/embroidery computer to your BERNINA dealer. This message will therefore only come on again after the next period of sewing/embroidering has been accomplished.
- Main Motor failed. Please check hook system.



Note

Check the settings in the Setup Program and try again.

Check the settings in the Setup Program and try again.

Connecting problems. Enter another provider if possible or try again.

Remove modem, then reconnect.

The myartista portal provides tips and news.

Try to connect to myartista portal again. Remove modem and reconnect in necessary.

This message appears at approx. 180'000 stitches. Press «OK» to close message after cleaning and oiling. Press «ESC» to temporarily «delete» the message. It will, however, reappear after restarting the sewing/embroidery computer. After «deleting» it three times by pressing «ESC», the message will not appear again before another approx. 180'000 stitches will have been stitched.

Take the sewing/embroidery computer to the BERNINA dealer for servicing. This message appears at approx. 2'000'000 stitches. After servicing, the stitch counter is reset to «0» by the Bernina servicing staff. Press «ESC» to temporarily «delete» the message. It will, however, reappear after restarting the sewing/embroidery computer. After «deleting» it three times by pressing «ESC», the message will not appear again before another approx. 2'000'000 stitches will have been stitched (i.e. at 4'000'000 stitches).

Flawless functioning of the sewing/embroidery computer can not be guaranteed if the servicing is not carried out at the recommended regular intervals.

Open bobbin cover. Remove lint and thread remnants and clean hook system.

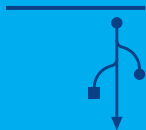

Peripherals 260

- BERNINA computer system
- Connecting peripherals

Accessories 262

- Suitcase system
- Embroidery Mega-Hoop
- Embroidery cards
- BERNINA artista software
- USB Stick



Peripherals and Accessories

BERNINA Computer System

Connect peripherals (special accessories) to turn your **artista 730** embroidery computer into an embroidery computer system, and take your hobby to unlimited heights of creativity. In addition to a direct connection with the myartista Portal (information source), which takes you to the Portal site especially created for the embroidery computer, it is also possible, for instance, to get extra motifs from a OESD USB Stick.

Ask your BERNINA dealer for more information.

Peripherals

The following external devices can be connected to the artista 730 embroidery computer:

- BERNINA Modem
- BERNINA-Ethernet Card

Note:
All peripherals are special accessories, depending on country. Ask your BERNINA dealer for information!

External Devices



Modem / Ethernet Card (for access to myartista Portal)

It is possible to directly connect to the myartista portal (= information platform) and access the sites that have been especially programmed for the embroidery computer via screen on your artista 730. Simply connect the BERNINA modem or Ethernet Card. The myartista portal provides embroidery designs – grouped by hoop size – to be downloaded to the embroidery computer.



Connecting via Modem

- ❖ connect Modem
- ❖ touch «Portal»
- ❖ confirm message about connecting with «Yes»
- ❖ when the connection to the Provider is made, then confirm the message that appears with «OK»
- ❖ select the desired hoop from the now opened screen
- ❖ the embroidery motif overview for the corresponding hoop size appears



Connecting via Ethernet Card

- ❖ Connecting the Ethernet Card
- ❖ press "Portal"
- the embroidery computer tries to find an active Internet connection
- connection established, the hoop overview screen appears
- ❖ select the required hoop
- ❖ a collection with motifs to fit into the selected hoop appears

The content of the myartista Portal is continuously updated.

Connecting Peripherals (Embroidery Computer Compatible)



Connecting Peripherals

- ❖ plug external device into socket provided on the right hand side of embroidery computer (look for symbol)

Note:

The external devices include user instructions!

Caution:

You must only use BERNINA external devices with the BERNINA artista 730 embroidery computer.

- 1 BERNINA Modem
BERNINA Ethernet Card
BERNINA Embroidery Card



- 2 USB Stick



- 3 PC connection



Ask your BERNINA dealer!

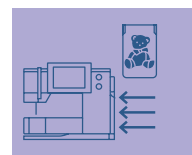

BERNINA provides a variety of extra accessories to go with the **artista 730** sewing/embroidery system for new and unlimited opportunities in your sewing and embroidery. Ask your BERNINA dealer for detailed information.



Suitcase System

Thanks to the suitcase system with integrated wheels especially developed for the sewing and embroidery computer, you will be able to carry the latter with particular ease and elegance. The case houses both standard and special accessories in conveniently arranged compartments and bags.

Accessories

Note:

The suitcase system protects the computers from dust and dirt, as well as humidity, for short distances.



Suitcase for Sewing Computer

- ❖ simply remove bags and compartments to place the sewing computer in the suitcase for storage (screen faces front)
- ❖ load compartments and bags with standard accessories and replace
- ❖ the bags provide space for additional special accessories



Suitcase for Embroidery Computer

- ❖ simply remove bags and compartments to place the embroidery module in the suitcase for storage (embroidery arm faces front)
- ❖ load compartments and bags with standard accessories and replace
- ❖ the bags provide space for additional special accessories

Caution:

When travelling by plane, coach or train, the suitcase system must be transported as carry-on luggage only, or «fragile goods»! The suitcase system must not be transported as normal luggage!

Embroidery Mega-Hoop



Use the embroidery Mega-Hoop to stitch extra large motifs, large design combinations, or long borders with ease. With the Mega-Hoop three embroidery positions are possible. If the Mega-Hoop has been repositioned, the embroidery computer stops and a message indicates, to which embroidery position (1, 2 or 3) the Mega-Hoop has to be moved. Use the VAR.00 template with the artista 730.



Extra large motifs for use with the Mega-Hoop can, for example, be downloaded from myartista Portal if your embroidery computer is connected to the BERNINA Modem or the BERNINA Ethernet Card.

Note:
The embroidery Mega-Hoop includes user instructions!

Embroidery Cards



1 Embroidery card



In addition to the preprogrammed BERNINA embroidery cards available as a supplement to the designs already in the embroidery computer, there are «empty» personal design cards available to save embroidery designs or embroidery design combinations.

The preprogrammed BERNINA embroidery cards contain a number of embroidery designs on a specific theme. The subject areas are continually supplemented and extended.

With this embroidery computer also older preprogrammed BERNINA embroidery cards can be used.

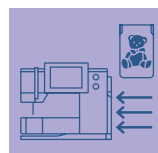

Caution:
Do not remove embroidery cards when the computer is in use!

Note:
When using older BERNINA embroidery cards (e. g. artista 180) please refer to the color chart (enclosed with card) for color details!

Inserting Embroidery Cards

- ❖ slide design card into the slot provided on the right hand side of the embroidery computer (look for symbol)
- designs can now be opened and displayed on screen

Removing Embroidery Cards

- ❖ touch Embroidery Card Removal button
 - button extension appears
- ❖ touch button again
 - embroidery card appears in card inserting slot on embroidery computer
- ❖ remove embroidery card

USB Sticks



2 USB Stick



In addition to the preprogrammed OESD embroidery designs data sticks for extra embroidery designs, there are also blank memory sticks (BERNINA Personal Memory Stick) to save embroidery designs or design combinations.

The preprogrammed OESD sticks contain a number of topic-related embroidery designs. The topics are continuously added to and the collections extended. A large selection of all topics is available at www.embroideryonline.com or at your BERNINA dealer's.

Connecting the USB embroidery designs stick

- ❖ plug stick into provided port on embroidery computer (note symbol) the contents can be accessed via screen

Removing the USB embroidery designs stick

- ❖ pull stick out

Note:

If you want to combine designs from different embroidery designs sticks, you will **have to** save the individual motifs into the memory of the embroidery computer first (refer to pages 248-249). Then the motifs can be taken from the memory to combine them.

Caution:

Do not remove the embroidery designs stick from the embroidery computer when in process.

BERNINA artista Embroidery Software



3 PC connection



Use the BERNINA artista PC software to combine, extend, and change existing motifs on a personal computer (PC). The software even allows you to create motifs all on your own. The whole design process lies in your hands: from first draft, to final transformation into embroidery stitching, the choices are all yours!

The finished designs you have created are transferred via a USB connecting cable directly to the embroidery computer, where you can embroider them. The USB connecting cable comes with the embroidery module.

Plugging USB Connecting Cable from the PC into the Embroidery Computer

- ❖ plug USB connecting cable into socket provided on the right hand side of embroidery computer (look for symbol)

Embroidery Design (PC) Saving Options

- on PC
- on artista 730 embroidery computer
- on a personal design card
- on a BERNINA USB Memory Stick

Note:

The BERNINA artista embroidery software includes user instructions!

Ask your BERNINA dealer for other accessories for your embroidery computer!

Glossary

Add

- to add means to combine by addition, to join, to increase
- adding a new motif

auto

- for example in connection with sewing buttonholes:
- if the length is preprogrammed «auto» appears, i.e. the buttonhole is stitched in the programmed length automatically (by itself)

auto/repeat

- to repeat means to redo, hence auto repeat redoing something by itself
- keeping the external needle position button pressed leads to rapid automatic moving of the needle position (by itself)

Balance

- to balance a stitch or motif means to alter a stitch or sideways motion stitch to correct distortions

Calibrate

- to calibrate, to gauge, to measure
- calibrating means determining measures, setting the screen or the embroidery module

Check

- to check, to examine, to inspect
- when embroidering, the computer checks which embroidery hoop is mounted, and «travels» the fabric to check on the position of the motif

clr (clear)

- to clear, to delete
- functions or commands can be deleted and reset to the original position

Duplicate

- to duplicate means to double, to copy, to multiply (making exact copies)
- duplicating a motif means that the active motif is copied exactly

Edit

- to edit, to write
- motifs are edited in the screen (Edit 1 or Edit 2, for example mirrored, scaled, etc.)

ESC

- closing a function, going back to original position (e.g. to original screen settings)

Fall

- autumn
- the artista 730 embroidery designs are divided into the four seasons – spring, summer, **fall** and winter

Help

- help, to help, to assist
- a program that is built into the sewing and embroidery computer which gives e.g. information (help) on stitches, functions, etc.

History

- history, record, development
- artista 730 displays a maximum of 15 most recently selected and sewn stitches in the «History» function

manual

- a manual buttonhole is sewn in four or six steps (depending on the type of buttonhole). The sewer manually changes the positions on screen.

Mega-Hoop

- mega means very large, hoop means frame
- extra large embroidery hoop for stitching very large motifs or long borders

Memory

- store
- programs and data are saved and prepared for processing
- the memory of the sewing and embroidery computer can be used to save e.g. stitch combinations or motifs

Menu

- summary, overview, selection of functions
- z.B. Alphabetauswahl

Modem / Ethernet Card

- a Modem or Ethernet Card is used to transfer data to the artista 730 sewing and embroidery computer via the phone network

New

- opening a new motif

OK

- confirming the command entered or change that has been made

PC

- Personal Computer

Peripheral

- device that is not part of the central unit of a computer system
- artista 730 for example features a Modem or a Ethernet Card as peripherals

pop-up

- pop-up menu («pops up» or opens suddenly)
- special screen that opens, listing entries from which to select, when touching the arrow next to an entry bar

Portal

- door, gate, entrance
- special information source for artista 730
- the Portal especially designed for artista 730 is myartista Portal. On connecting the BERNINA Modem or Ethernet Card and selecting the function «Portal» your artista 730 sewing computer connects with myartista Portal, from where you can e.g. download motifs

Provider

- someone who offers communication services (e.g. access to the Internet)
- the Provider opens access to the myartista Portal for artista 730. There are various Providers. You are free to choose any of them. Enter Provider name, Provider number, user name and password to make the connection

Pull Compensation

- adjusting excessive spacing/overlap of motif
- is used for example when the outline is not correct or the motif is distorted

Ready

- prepared, waiting to begin
- «ready» in the Embroidery menu (Ready) means that the motif can be stitched immediately

recording

- to record, to preserve, to tape
- the stitch counter records or programs the number of stitches used
- the stitch counter records the stitched length of a buttonhole

Reset

- to set again, to put back, to restore
- a change made is undone, i.e. reset to the original settings

scroll

- to browse
- if a comprehensive file (e.g. selection of stitches) cannot be displayed in full, the «scroll» tool can be used to display further sections on screen

sensor

- signal receiver, measuring sensor

Setup

- to determine, to begin
- structure
- in the Setup Program you can for example adjust your personal requirements

software

- generic term for programs (i.e. computer programs)
- as opposed to hardware, which is the term used to describe any physical or tangible components of a computer (e.g. the casing, motor, etc.)

Spring

- spring (the season)
- the artista 730 motifs are divided into the four seasons **spring**, summer, fall and winter

Summer

- the artista 730 motifs are divided into the four seasons spring, **summer**, fall and winter

touch screen

- sensor screen
- touch-sensitive surface. Touch the symbols/keys on the screen with a finger or pen

Tutorial

- self-help program for learning about various sewing and embroidery computer features

Update

- latest version
- updating the sewing and embroidery computer software: installing a new version

Upgrade

- to take to a higher level
- upgrading the sewing and embroidery computer means improving or extending its functions

USB

- Universal Serial Bus
- the sewing and embroidery computer provides for USB connections

Windows CE

- CE stands for Consumer Electronic
- the operating system used with artista 730 sewing and embroidery computers

Winter

- winter
- the artista 730 motifs are divided into the four seasons spring, summer, fall and **winter**

Zoom

- to focus on, to enlarge, to rescale
- motifs can be 'zoomed' (enlarged or reduced view of motif)

Practical Stitches



Buttonholes



16 Directions Sewing



4 Directions Sewing



Decorative Stitches 9mm / 40mm

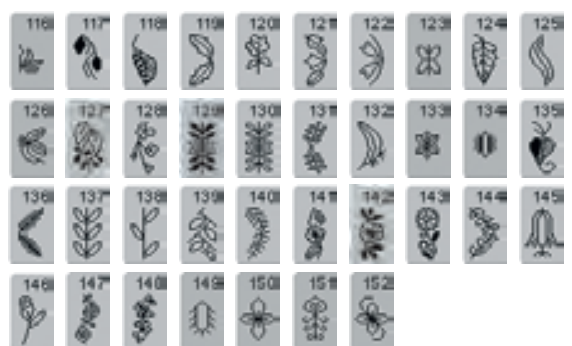

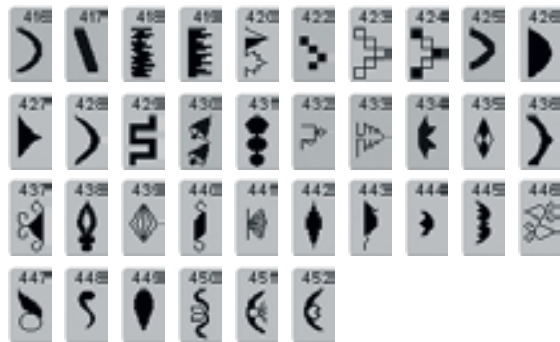





Zodiacs



Quilt Stitches

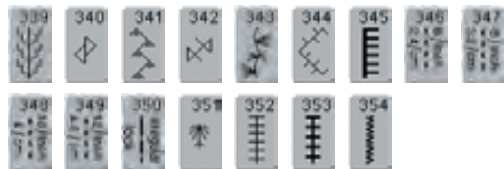

Alphabets



T	U	V	W	X	Y	Z	Ä	Ö	Ü
Å	Æ	Œ	Ø	Ñ	È	É	Ê	À	Â
1	2	3	4	5	6	7	8	9	0
-	-	·	·	!	+	=	&	÷	?
%	ç	@	()	[]			



t	u	v	w	x	y	z	ä	ö	ü
å	æ	œ	ø	ñ	è	é	ê	à	â



T	U	V	W	X	Y	Z	Ä	Ü	Ü
Å	Æ	Œ	Ø	Ñ	È	É	Ê	À	Â
1	2	3	4	5	6	7	8	9	0
-	·	·	·	!	?	%	@	(
)	[]							



t	u	v	w	x	y	z	ä	ö	ü
å	æ	œ	ø	ñ	è	é	ê	à	â



7 2 7 7 2 2 2 2 2 2
 2 2 2 2 N 8 8 8 2 2
 1 2 3 4 5 6 7 8 9 0
 - - . ' / + = & ÷ ?
 % £ @ () []



t u v w x y z a o u
 à œ œ ø ñ è é ê à à



U V W X Y Z A O A A
 O X

Spring



Daffodils

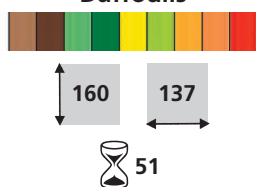

Iris

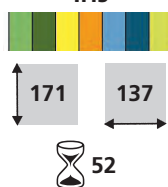

Little pansies

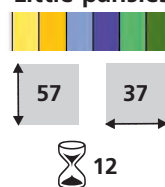

Floral wreath

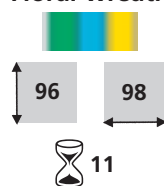

Butterfly

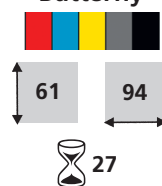

88 Width in mm

127 Length in mm

51 Embroidery time in minutes

Summer



Little wild rose



62 58



White rose



196 119



Fuchsia



216 134



Flowers with butterfly



61 127



Lace border



52 148



Daisy



50 36



Fall



3 Quilts

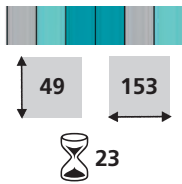

Quiltoutline

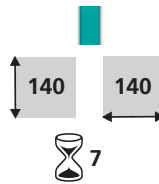

Mushrooms

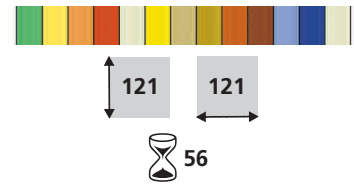

Sunflower

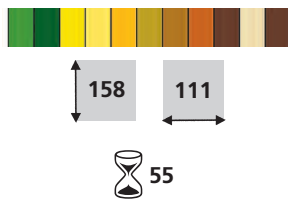

Grape leaf

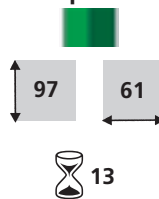

Winter



Sprig of pine

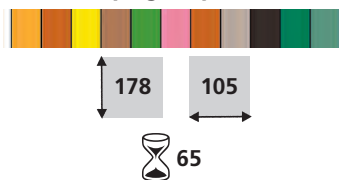

Holly and bird

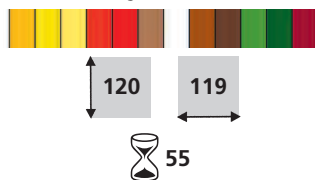

Holly and heart

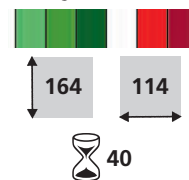

Royal fdl

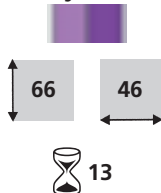

Lace heart

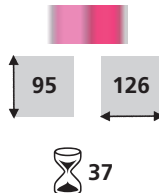

Alphabets



Alice

Font height: min. 8mm / max. 50mm



Blackboard

Font height: min. 8mm / max. 50mm



Childs Play

Font height: min. 13mm / max. 30mm

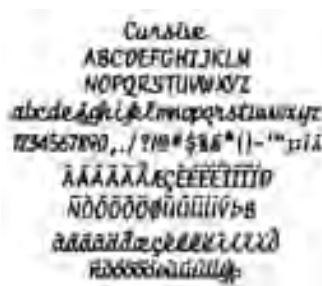

Cursive

Font height: min. 7mm / max. 60mm

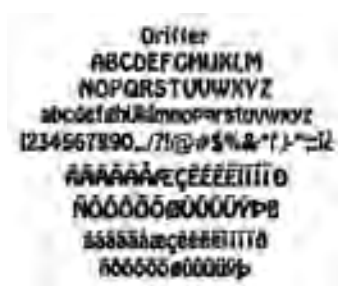

Drifter

Font height: min. 6mm / max. 40mm



King Charles

Font height: min. 8mm / max. 50mm



Lisa

Font height: min. 13mm / max. 75mm

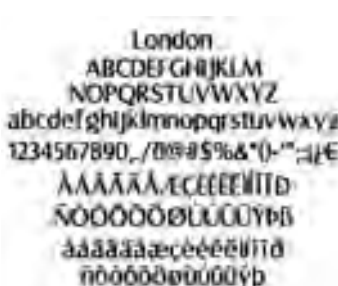

London

Font height: min. 8mm / max. 50mm



Swiss block

Font height: min. 6mm / max. 60mm

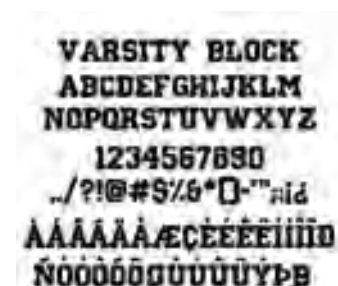

Varsity block

Font height: min. 6mm / max. 35mm

Index

A

- 4 Directional Sewing **96**
- 16 Directional Sewing **94**
 - Connecting Stitches **95**
- Accessories **262-264**
 - artista Embroidery Software **264**
 - Embroidery Cards **263**
 - Embroidery Mega-Hoop **263**
 - Embroidery USB Sticks **264**
 - Suitcase System **262**
- Accessory Box **10**
- Accessories Embroidery **197-198**
- Accessories Sewing **10**
- Adjusting Motifs **242**
- Alphabets, Lettering for Embroidery **234-239**
 - Altering Lettering **235-237**
 - Combining Lettering **237-238**
 - Combining Letters **234**
 - Combining Motifs and Lettering **238-239**
 - Correcting Letters **234**
- Alphabets, Lettering for Sewing **97-108**
 - Change Size **101**
 - Combining Lettering **100**
 - Combining Lettering and Functions **101-102**
 - Correcting Combinations **102, 108**
 - Monogramming Information **103**
 - Monogram Size 1 **104-106**
 - Monogram Size 2 **107-108**
 - Selecting **99**
 - Select Lower Case **101**
 - Summary **98**
- Altering Motifs **227-230**
 - Adjust the Motif Height or Width **230**
 - Enlarging or Reducing Motif Proportionally **229**
 - Mirroring Motifs **227-228**
- Altering Needle Position **24**
- Altering Stitch Length **23**
- Altering Stitch Width **23**
- Attaching the Embroidery Hoop **204**
- Attaching the Embroidery Module **199**

B

- Balance
 - Buttonholes **113**
 - Practical and Decorative Stitches **183**
 - Sideways Motion Stitches **184**
- Bartack Program **71**
- Basting Stitch **49**
- Blind Hem **52**
- Bobbin case:
 - removing/inserting **13**
- Bringing up the Lower Thread **15**
- Buttonholes **109-133**

- Automatic Buttonhole Standard and Stretch **119-120**
 - Automatic Buttonhole with Direct Entry Length **116**
 - Automatic Buttonhole with Button Measuring on Screen **117**
 - Automatic Round, Keyhole and Hand-look Buttonhole **121-122**
 - Balance for Buttonholes **113**
 - Bound Buttonhole **129-130**
 - Buttonhole in Long Term Memory **118**
 - Buttonhole Program Functions **111**
 - Corded Buttonhole **114-115**
 - Decorative Buttonholes **131**
 - Height Compensating Plate for Buttonholes **115**
 - Important Information **112**
 - In General **111**
 - Manual 4 or 6 Step Buttonhole **125-126**
 - Stitch Counter Buttonhole **123-124**
 - Straight Stitch Buttonhole **127-128**
 - Summary **110**
- Button Sew-on Program **132**

C

- Calculating New Embroidery Data **228**
- Changing the Needle **15**
- Changing the Presser Foot **21**
- Cleaning and Maintenance **185**
- Combining Motifs **231-233**
 - Adding Another Motif **231**
 - Corrections and Alterations in the Motif Combination **233**
 - Creating Motif Combination **232**
 - Duplicating Existing Motif **231**
- Connecting Peripherals **194, 261**
- Connecting the Adapter for Free Arm Embroidery **200**
- Creative Consultant **181-182**
- Cross Stitches **81**

D

- Darning Manual **68**
- Darning Program **67**
- Decorative Stitches **73-96**
 - Applications **75-76**
 - Combining Decorative Stitches and Functions **77-78**
 - Decorative Stitches in the Combi Mode **79-80**
 - Selecting **75**
 - Summary **74**
- Details of the Embroidery Module **196**
- Details of the Sewing Computer **8-9**
- Different Stitch Types **216-217**
 - Fancy-Fill Stitches **217**

- Jump Stitches **217**
 - Outline Stitches **217**
 - Satin Stitch **216**
 - Step Stitch **216**
 - Underlay Stitches **216**
- Double Overlock Seam **55**

E

- Edgestitching **43-44**
- Elastic Edges **66**
- Embroidering Borders **245**
- Embroidering Lace **244**
- Embroidery Design Collection **274-277**
- Embroidery Motifs **224-225**
 - Embroidering Motif **225**
 - Motif Information **224**
 - Select Hoop **224**
 - View Motif in Detail (Zoom) **225**
- Embroidery Stabilizers **219-220**
- Embroidery Test **216**
- Embroidery Threads **218**
- Ethernet Card **192-193, 260**
- External Functions
 - Embroidery/ Sewing Mode Switch **213**
 - Stitch Width/ Stitch Length Knobs **213**
- External Function Buttons
 - Altering Needle Position **28**
 - Automatic Thread Cutter **28, 213**
 - Creative Consultant **28**
 - Clr (Clear) Button **28**
 - Favorite Function Button **28**
 - Pattern End (on head frame) **28**
 - Quick Reverse Button on Head Frame **28, 213**
 - Setup Button **28**
 - Tutorial **28**
- Eyelet Programs **133**

F

- Fabric, Needle, Threads **17**
- Feed Dog
 - Feed Dog and Fabric Feed **22**
 - Feed Dog Up/Down **21**
 - Lowered Feed Dog **33**
 - Sewing Corners **22**
- FHS (Free Hand System) **11**
- Flat Joining Seam **57**
- Fly Stitches **72**
- Foot Control **11**
- Free Arm Embroidery **243**
- Freehand Embroidery **70**
- Functions and Displays for Embroidery
 - Add Motif **208**
 - Check **207**
 - Color Information Bar **211**
 - Color Motif Display **208**
 - Color Numbers **207**
 - Delete **208**
 - Duplicate Motif **208**

- Embroidery Menu (Ready) **208**
- Embroidery Sequence Control **212**
- Embroidery Speed **212**
- Embroidery Time **207, 211**
- Help («?») **208, 212**
- Hoop Display **211**
- Hoop Relocator **211**
- Horizontal Mirror Image (left/right) **209**
- Letter Manipulation **210**
- Motif Center **207**
- Motif Information **207**
- Motif Properties **210**
- Motif Size **207, 211**
- Move Hoop **212**
- Move Motif **209**
- New Motif **208**
- Retrieve **208**
- Rescale Motif Height or Width **209**
- Rescale Motif Proportionally **209**
- Rotate Motif **209**
- Save **209**
- Screen Edit 1 **207**
- Screen Edit 2 **207**
- Select Hoop **207**
- Single/Multi Color Motif **212**
- Show Grid **208**
- Thread Tension **211**
- To Next Page – Edit 1 **210**
- To Next Page – Edit 2 **209**
- To Screen Edit 1 **211**
- Vertical Mirror Image (up/down) **209**
- Zoom **208**

Functions General

- Combi Mode **29**
- ESC **29, 206**
- Help («?») **29, 206**
- OK **29**
- Return to Selection Menu **206**
- Scroll Down **29, 206**
- Scroll Up **29, 206**
- Single Mode **29**
- Spinning Spool **206**

Functions Special

- Alphabet Size **31**
- Balance **32**
- Combination Sub-divider (1) **31**
- Combination Sub-divider (2) **31**
- Continuous Reverse Sewing **33**
- Delete **31**
- Direct Entry Length (in mm) or On-screen Button Measurement **31**
- File Drawers **33**
- History **33**
- Horizontal Mirror Image (left/right) **30**
- Indication of the Altered Stitch Width or Stitch Length **30**
- Long Stitch **30**
- Lowered Feed Dog **33**
- Manual 4 or 6 Step Buttonhole **31**
- Monogram Size **31**

- Motor Speed **32**
- Multifunction Button **31**
- myartista Portal **33**
- Needle Stop Adjustment **31**
- Pattern Begin **30**
- Pattern Extend 2-5x **30**
- Pattern Repeat 1-9x **32**
- Presser Foot Indicator **30**
- Programming Buttonhole Length **31**
- Save **31**
- Securing Function (with 4 stitches) **32**
- Security Program **32**
- Stitch Counter **31**
- Stitch Selection by Number **33**
- Thread Tension **32**
- Upper Case/Lower Case **31**
- Vertical Mirror Image (up/down) **30**

G

- Gathering Stitch **63**
- Glossary **265-267**

H

- Heirloom Techniques **82-88**
- Corded Scallops **88**
- Hemstitching **83**
- Pintucks **84-86**
- Scallops Off the Edge **87**
- Sewing Lace **82**
- Help Program **178**
- Hems With Double Needle **60**
- Hoopng the Fabric **221-222**
- Honeycomb Stitch Edges **54**

I

- Important Embroidery Information **215-218**
- Important Facts about Thread and Needles **17**
- Important Safety Instructions **1-2**
- Inserting the Bobbin **14**

J

- Jersey Overlock Seam **55**

L

- Long Stitch **40**

M

- Messages **188-190, 256-258**
- Modem **192-193, 260**
- Motif Colors **240-241**
- Embroidering Individual Color Sections **241**
- Embroidering Lettering in Multi Colors **241**
- Embroidering Motifs in One Color **241**
- Reallocating Motif Colors or Thread Brands **240**
- Motif Information **224**
- Needle Summary **18-19**
- Needle/Thread Combination **18**
- Needle, Thread, Fabric **17**

- Needle Threader **15**

P

- Patching Knits and Jersey **69**
- Peripherals **192-194**
- Personal Program **153-156**
- Altering Stitches **156**
- Deleting Stitches **155**
- Programming Screen **154**
- Selecting Stitches **155**
- Positioning Motif **226-227**
- Check the Motif Position **227**
- Checking Motif Center **227**
- Move Motif **226**
- Rotate Motif **226**
- Power Cable **11**
- Power Switch **11**
- Practical Stitches **35-72**
- Adjusting Individual Practical Stitches **38**
- Practical Stitches in the Combi Mode **79-80**
- Practical Stitch Seams **38**
- Sewing Knit Fabrics **53**
- Summary **36-37**
- Preparing the Embroidery Computer for Embroidery **201**
- Presser Feet **20**
- Presser Foot Indicator **24**
- Presser Foot Pressure **21**
- Pull Compensation **242**

Q

- Quilt Stitches **135-152**
- Blanket Stitches **145**
- Decorative Quilt Stitches **142**
- Different Techniques **137**
- Freehand Quilting **148**
- Hand-look Quilt Stitch **141**
- Piecing Stitch/Straight Stitch **140**
- Quilters Securing Program **138**
- Quilting Straight Stitch **139**
- Satin Stitch **143-144**
- Summary **136**
- Turned-edge Appliqués **146-147**
- Quilting with BSR **149-152**
- Activating the BSR Sewing Function **151**
- Application with Straight Stitch or Zig-zag **151**
- Beeper Deactivation/Activation **151**
- BSR Function Deactivation **151**
- BSR Mode 1 **149**
- BSR Mode 2 **149**
- Deactivating the BSR Sewing Function **151**
- In General **149**
- Preparation **150**
- Using Function in the BSR Mode **150**

R

- Reinforced Edges on Woven Fabric **62**
- Reinforced Overlock Seam **56**
- Restoring the Basic Settings **24**
- Ribbing Finish **61**
- Ribbing With Overlock Seam **59**
- Run Length **242**

S

- Saving Altered Settings Permanently **24-25**
- Saving and Deleting Motifs **247-252**
 - Deleting a Saved Motif **251**
 - Deleting All Saved Motifs **252**
 - Overwriting Motifs **250-251**
 - Saving to a Personal Design Card **249**
 - Saving to a Personal Memory Stick **250**
 - Saving to the Embroidery Computer **248-249**
- Saving and Deleting Stitches and Stitch Combinations **157-162**
 - Correcting Stitch Combinations **161**
 - Deleting Drawer **162**
 - Drawer Content at a Glance **160**
 - Empty Stitch Altering Area **159**
 - In General **158**
 - Mirroring Entire Combination **162**
 - Opening Empty Drawer **160**
 - Opening Saved Combination **160**
 - Programming and Saving Stitch Combinations **158-159**
 - Sub-dividing Combinations **162**
- Screen **12**
- Securing Stitch **42**
- Selecting Embroidery Motifs **202-203**
- Selecting Functions **24**
- Selecting the Embroidery Hoop **204, 207**
- Setup Program **163-175**
 - Customize Favorite Function Button **170**
 - Display Settings **165**
 - Embroidery Settings **167-168**
 - Hardware **175**
 - Information **170-171**
 - In General **164**
 - Messages and Audio Settings **172-173**
 - Portal Provider Settings **174**
 - Reset to Factory **175**
 - Sewing Settings **166**
 - Text in Welcome Screen **165**
 - Touch (Screen Sensibility) **169**
- Sewing Knit Fabrics **53**
- Sewing on Narrow Elastic With Universal Stitch **64**

- Sewing on Wide Elastic **65**
- Shadow Embroidery **246**
- Sideways Motion Stitches **89-93**
 - Automatic Connection With 16 Directional Sewing **92-93**
 - Combining Manually With Templates **91**
 - In General **89-90**
- Simple Menu Selection **26-27**
- Slide-on Table **12**
- Spool Pin
 - horizontal **13, 14, 16, 201**
 - vertical **16**
- Starting to Embroider **204-205**
- Stitch Density **242**
- Stitch Plates **17**
- Stitch Selection **23, 25**
- Stitch Summary **268-273**
- Straight Stitch **41**
- Stretch Overlock Seam **56**
- Summary of the Contents **5**
- Super Stretch/Stretch Seam **56**

T

- Temporary Altered Stitch Memory **24, 39**
- Thread Breakage **254**
- Thread Cutter
 - Automatic Thread Cutter **28, 213**
 - on Bobbin Winder **13**
 - on Head Frame **15**
- Thread Tension **34**
- Thread, Needle, Fabric **17**
- Threading the Bobbin Thread **201**
- Threading the Upper Thread **14, 201**
 - Double Needle, Triple Needle **16**
- Triple Straight Stitch **48**
- Trouble Shooting **186, 255**
- Tutorial **179-180**
- Tutorial USB Stick **193**

V

- Vari-Overlock Seam **55**
- Visible Hem With Jersey Stitch **58**
- Visible Hem With Triple Zig-zag **51**

W

- Winding the Bobbin **13**

Z

- Zig-zag Stitch **50**
- Zippers **45-47**
- Zoom (View Motif in Detail) **225**