

LONGARM QUILTING

QUILTING

REIMAGINED

SWISS
ENGINEERING



made to create **BERNINA**

MORE FEATURES. MORE FREEDOM.

A whole new world of possibilities.

Every longarm machine lets you sew larger quilts, but only one takes quilting to places it's never been before. From the moment you first drive a BERNINA Q Series Longarm, you'll appreciate the ergonomics, the smooth glide of the machine on the fabric, and the impeccable stitch quality. That's because every machine in the BERNINA Q Series is synonymous with Swiss engineering, awe-inspiring precision, and unrivalled innovation.

BERNINA has combined its 130-plus years of innovation with the wisdom of longarm quilters to create the amazing Q Series. Thanks to the many exclusive features, quilters can now experience a whole new level of creativity. The result is a series of longarm machines that deliver outstanding performance.

Whether you select a Q Series on Frame or a Q Series Sit-down, you'll enjoy exceptional features – from the customisable interface to the generous throat space to the ease of threading and the innovative BERNINA Stitch Regulator.

Once you take any of our BERNINA Longarm machines for a test drive, you'll see why ordinary longarm machines simply can't compare.

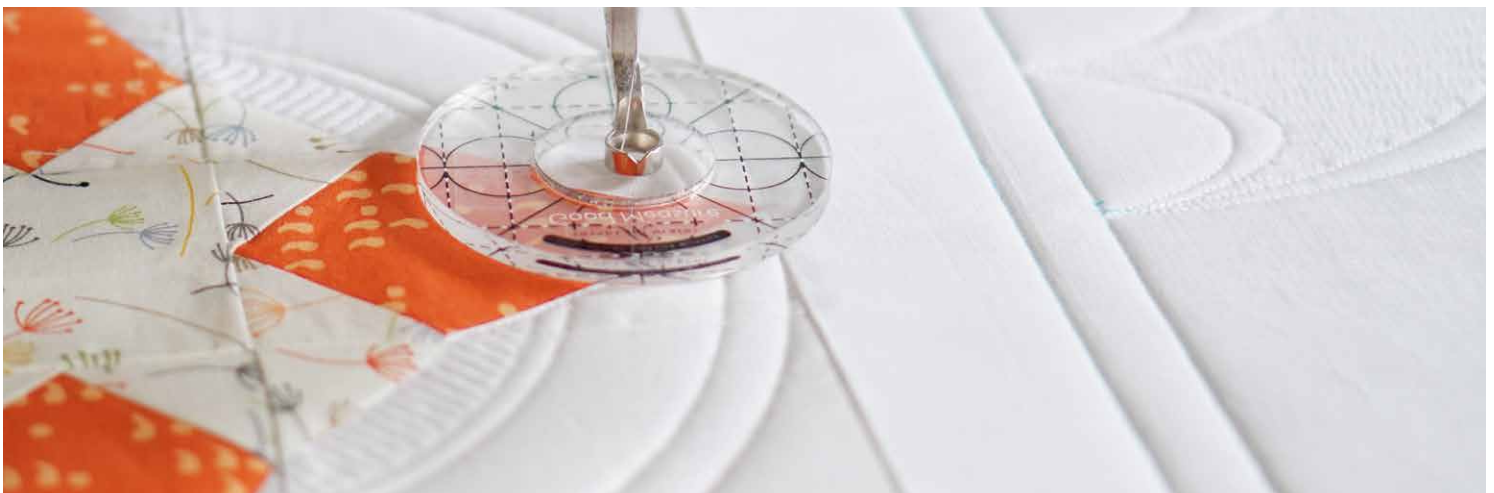



BERNINA Stitch Regulator (BSR)

Equipped with two optical sensors, this innovative system offers superior stitch quality and maximum flexibility. There are three modes, which result in impeccable stitches at any length, regardless of how fast or slow you move the fabric or machine. A manual mode with no stitch regulation is also available.



Unique Threading Path

The spool holders are positioned towards the front of the machine with a threading path that's simple to follow. The short thread path supports optimum thread tension.



Upper Thread Tension Control

BERNINA delivers electronically adjustable and numeric thread tension control. With just a few easy clicks, you can digitally adjust thread tension, and track the settings for your favourite thread types and combinations.



Integrated Bobbin Winder

This on-board bobbin winder (M Class bobbin) conveniently winds coordinating bobbin threads for your projects, independent of machine operation.



Optional Quilting Automation*

Compatible with the Q 16 PLUS, Q 20 and Q 24 on frame, the BERNINA Longarm Quilting Automation System (Q-matic) perfects the art of automation. You have to see it, to believe it!

*Not available in all markets.



“Quilting for me is about making a beautiful top even more beautiful. By quilting, I can add design elements that perfectly support the patchwork. Thanks to my BERNINA Q 24, mastering this challenge is easy.”

IVA STEINER, LONGARM QUILT ARTIST

Bobbin winder

lets you quickly prepare the exclusive, large, M-class bobbins from the front of the machine. You can also adjust winding speed on-screen, independent of machine operation.

4.3" colour touch screen

is easy to navigate and customisable, giving you optimum control over your quilting.

Upper thread tension control

adjusts thread tension digitally and tracks settings for your favourite thread types. You can save tension and machine settings in User Profile.

Fully operated from front

Dual hand wheels (front and back) control the needle, offering function and convenience regardless of operating position.

Programmable ergonomic handles

can be used on frame to maximise comfort and control, customisable in position and length.

Standard sewing needles

that are compatible with domestic machines can be used on our longarm; the flat-back needles are easy to insert in the correct position.

Dual BERNINA Stitch Regulator (BSR)

keeps stitches even and consistent regardless of quilting speed and quilt design complexity; comes with three BSR modes, including one for basting.

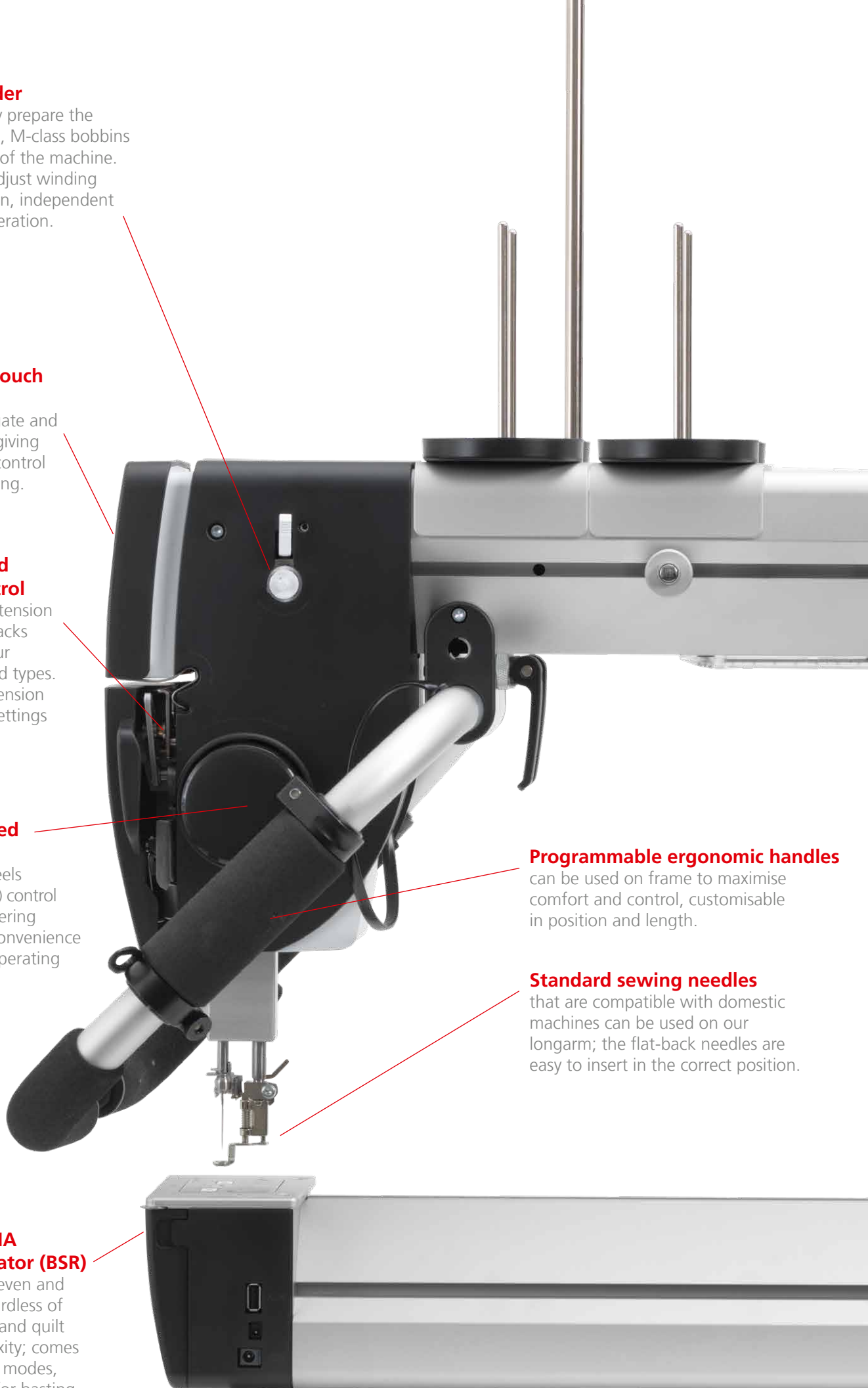

INTRODUCE YOURSELF TO THE BERNINA Q SERIES AND RE-THINK POSSIBLE.

Once you drive a BERNINA, nothing else will do.

Used to quilting on a domestic sewing machine? Imagine how much easier it would be if you had more space to manage and move big, heavy quilts. The BERNINA Q Series gives you that space. Lots of it. And that's not all. You'll also enjoy stitch regulation perfection,

easy free-motion quilting and a whole lot of exclusive features and capabilities you won't find in other machines. Of course, the only way to experience just how superior BERNINA is; come in and take one for a test drive. Your neck and shoulders will thank you.



LED Lighting

50 LED lights give you a variety of lighting options for the tasks that you're doing.

DIFFERENT QUILTERS HAVE DIFFERENT NEEDS.

Have the space to dream really big?

The Q 24 and Q 20 will take you where you want to be.

In addition to the BERNINA features mentioned earlier, the Q 24 and Q 20 on a frame have ergonomic handles that are adjustable, with toggles that can be programmed to your preference, giving you ultimate operating control.

Both the Q 20 & Q 24 are compatible with the BERNINA PRO Frame, which comes in three sizes: "Small", "Classic" and "Large." The Q 20 is also compatible with the BERNINA Studio Frame, allowing you to start small and upgrade to the PRO Frame later.

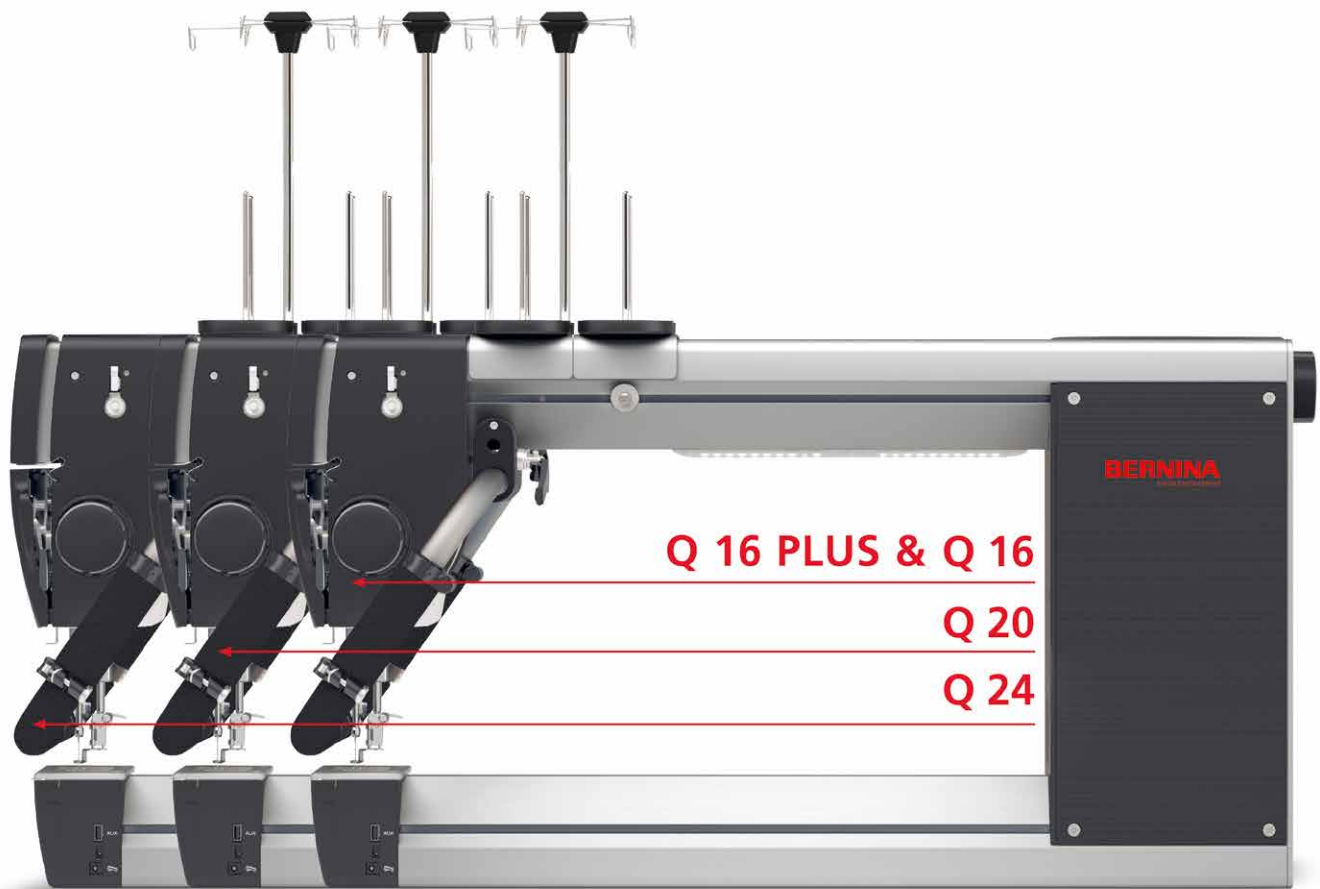

Have big ideas but not a lot of space?

Try a BERNINA Q 16, Q 16 PLUS or Q 20 on for size.

All three machines can be paired with the Adjustable Foldable Table or with the Q Series Lift Table. If you think you may want to upgrade to a frame, the BERNINA Q 16 PLUS and Q 20 pair with the BERNINA Studio Frame.

With 16" of throat space, both the Q 16 & Q 16 PLUS have more throat space than your domestic machine.

Meanwhile, the Q 20 gives you 20" of throat space and a little extra space to create.

Whatever you decide, you'll enjoy the exceptional benefits discussed on the previous page. The BERNINA Q Series gives you the freedom of control, and the confidence that comes with knowing your creativity doesn't have to be limited by the size of your space.





LOOK AT ALL THE GREAT FEATURES YOU'LL FIND ON EVERY BERNINA Q SERIES MACHINE:

- Conveniently Located 4.3" Colour Touch Screen
- 50 LED Lights for Optimum Freearm Illumination
- On-Screen Help, Animations & Tutorials
- Front Handwheel
- Back Handwheel
- Integrated Needle Threader
- Digital Upper Thread Tension Control
- Upper Thread Sensor
- M Class BERNINA Rotary Hook System
- On-board Bobbin Winder
- Bobbin Thread Indicator
- BERNINA Stitch Regulator (BSR)
- Maximum Stitch Length in BSR Mode (one stitch per inch)
- Minimum Stitch Length in BSR Mode (24 stitches per inch)
- Automatic Presser Foot Lift
- Five User Profiles
- Presser Foot System
Standard Foot: #9
- Optional Feet: #15, #24, #26, #29, #43, #44C, #72, #72S, #73, #74, #96
- Bobbin Thread Tension Gauge
- Machine Needle System is compatible with domestic machine needles
- Twin Needle compatible with optional Twin Needle Stitch Plate Accessory

Distinct Machine Features

BERNINA Longarm Model	Q 24 Frame	Q 20 Sit-down	Q 20 Frame	Q 16 PLUS Sit-down	Q 16 PLUS Frame	Q 16 Sit-down	Q 16 Frame
Throat Space (length and height)	24" L 11" H	20" L 11" H	20" L 11" H	16 ½" L 11" H	16 ½" L 11" H	16 ½" L 11" H	16 ½" L 11" H
Programmable Foot Control		✓		✓		✓	
Programmable Front Handles	✓		✓		✓		✓
USB Ports	2	2	2	1	1	1	1
Maximum Sewing Speed (stitches per minute)	2,200 SPM	2,200 SPM	2,200 SPM	2,200 SPM	2,200 SPM	2,000 SPM	2,000 SPM
Optional Accessory Connections	✓	✓	✓	✓	✓	✓	✓
Optional Q-matic* (automation)	✓		✓		✓		
Optional Pantograph	✓		✓		✓		

*Not available in all markets.

SIT DOWN, MAKE YOURSELF COMFORTABLE AND GET READY TO CREATE.

Big ideas. Small spaces.

When you combine the large throat space of the Q Series with our exclusive tables, you'll start to see how BERNINA is redefining the quilting experience. So get ready to bring your big ideas to life – even if you only have a small space.

High-speed precision. Exceptional ergonomics. Total customisation.

In a word, BERNINA. Whether you're sitting down at the Q 16, Q 16 PLUS or Q 20, you'll experience unrivalled freedom – from the roomy quilting space to the exclusive BERNINA Stitch Regulator to the ease of free-motion quilting. And with everything you need to operate the Q Series at the front of the machine, creating is easier and dreamier than ever before.

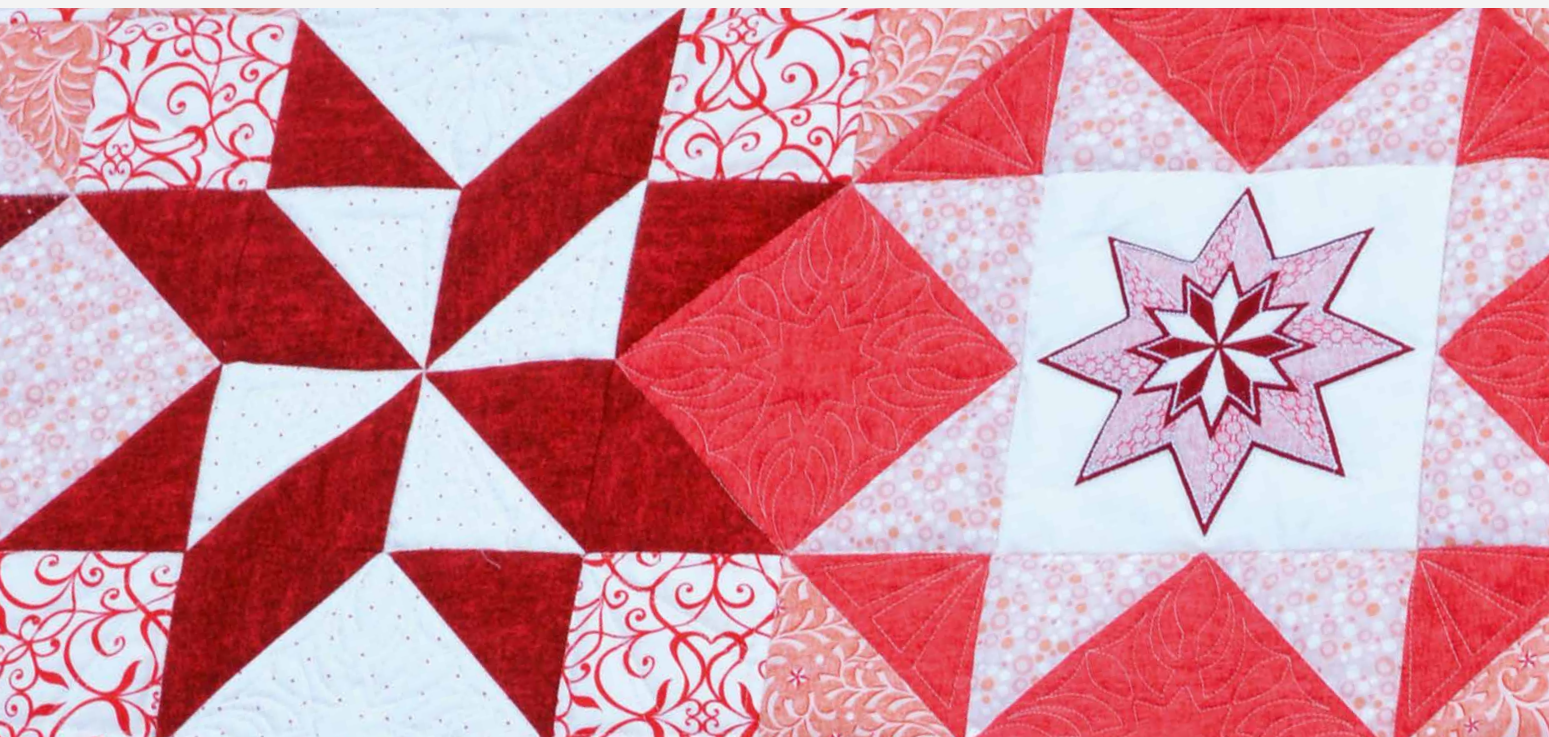

"I'm no longer limited to perfect stitches just on my sewing machine, now I get them on my Longarm."

RON STEINBACHER, QUILTING ENTHUSIAST



When it comes to comfort and choice, no one offers you more flexibility than BERNINA.

Our Q 16, Q 16 PLUS and Q 20 can be paired with sit-down options specifically to fit your needs. From our height-adjustable Q Series Lift Table with a generous work area to a foldable version for optimal storage, you're sure to find your perfect set up. Plus, our Q 16 PLUS and Q 20 can grow with you because they also work on our frames and are automation ready.



“The perfect match for longarm lovers like me.”

AMANDA MURPHY, QUILT AND PATTERN DESIGNER

WHEN IT COMES TO SIT-DOWN QUILTING, EVERY CHOICE IS Q-PERFECT.

HOW YOU SUPPORT YOUR QUILTING VISION IS UP TO YOU.

BERNINA tables are designed to fit the Q 20, Q 16 PLUS, and Q 16 longarm machines. The variety of sizes, options, and features ensures you'll find the one that works best for your space and specific quilting needs.

POWER UP YOUR QUILTING WITH OUR Q SERIES LIFT TABLE.*

This powered, height-adjusted table is a favourite choice. Not only does it make it easy to adjust your quilting position, the hinged side leaves also provide extra quilting space that extends out, which is really great for larger, bulky quilts. Whether you're sitting or standing, it's just one more way BERNINA powers up your quilting potential.

- Easy Adjustable Height from 72 to 121 cm / 28" to 48"
- Size tabletop: 125 x 100 cm / 49" x 39"
- Size tabletop expanded: 200 x 100 cm / 79" x 39"
- Electrical height adjustment
- Casters included
- Integrated storage solutions
- Intuitive, easy, and fast set-up

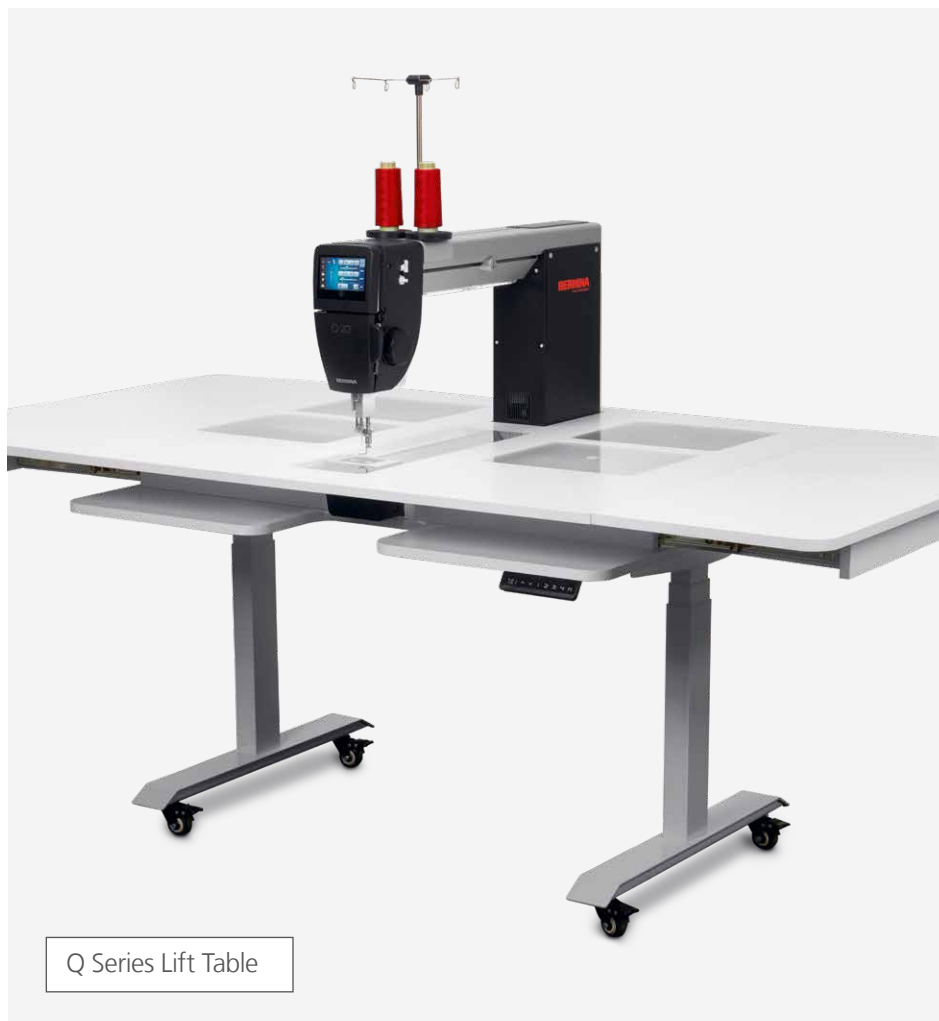

* Not all tables are available in all countries. Please check with your local dealer for available table options.



THINK BIG IN SMALL SPACES WITH OUR FOLDABLE TABLE.

Space-saving design. Affordable price. Superior quality. With this super-compact table, space is no barrier to bringing your big ideas to life. It can be set to three different heights and gives you a surprising amount of working surface. Once you're done, remove the machine, and the table folds down to a width of 9 inches for easy storage.

- For small space requirements
- Height positions: 71, 76 and 81 cm / 28", 30" and 32"
- Size tabletop: 90 x 120 cm / 36" x 47"
- Fast and comfortable set up
- Easy store away
- No tools required



Adjustable Foldable Table



ERGONOMIC
OPERATION,
FULLY FROM
THE FRONT



TAKE THE WEIGHT OFF YOUR SHOULDERS AND LET A BERNINA PRO FRAME CARRY IT FOR YOU.

Take your creations to a whole new level of "WOW!"

When you drive the Q 20 or Q 24 on a quilt frame, you create from the top down; mastering your large creations as you go and taking them places you never imagined possible. Available in "Small", "Classic" and "Large" sizes, the exceptional BERNINA PRO Frames showcase your personal quilting style while accommodating your unique floor space needs.

Whatever masterpiece you're creating, the frame's strong, robust design readily handles the high speeds of longarm quilting. Constructed from anodised aluminum, this lightweight yet sturdy frame can handle the weight, size, and speed of the BERNINA longarm machines with ease.

Another great thing about an on-frame machine is that you can add automation, so the belts drive the machine. Talk about the power of creativity!*

*Q-matic is not available in all markets.

8'10" / 11'11" / 12'11"



PRO FRAME FOOTPRINT

Give your creativity a little elbow room

Remember to allow 2 feet of space beyond the specs listed here for the pantograph kit. Ask your dealer about a Q Series rollout mat. This mat is an actual sized picture for you to see what it could look like in your dream room.



SMALL SPACES. **BIG IDEAS.**

SMALL SPACE. BIG IDEAS. HUGE POSSIBILITIES.

Ever feel like your quilting aspirations are bigger than your space? Now they don't have to be. The BERNINA Studio Frame is a modular frame and can be assembled as small as 5 ft or to its full size of 10 ft. The Studio Frame is spacious enough for your biggest projects and sturdy enough to handle all the performance features of the Q 16 PLUS and Q 20 Longarm.

Big on quality, the Studio Frame is the more affordable option in our selection of quilting frames and has the flexibility to size up or down depending upon your needs.

At 10-ft, you can create a quilt or larger piece of quilted art. Create small. Create big. Create to your heart's content.

BERNINA Studio Frame: Quick, easy to assemble and perfect for the Q 20 or Q 16 PLUS

- Modular frame
- For quilts up to 104"
- Also works with the Q 16
- Q-matic automation* available

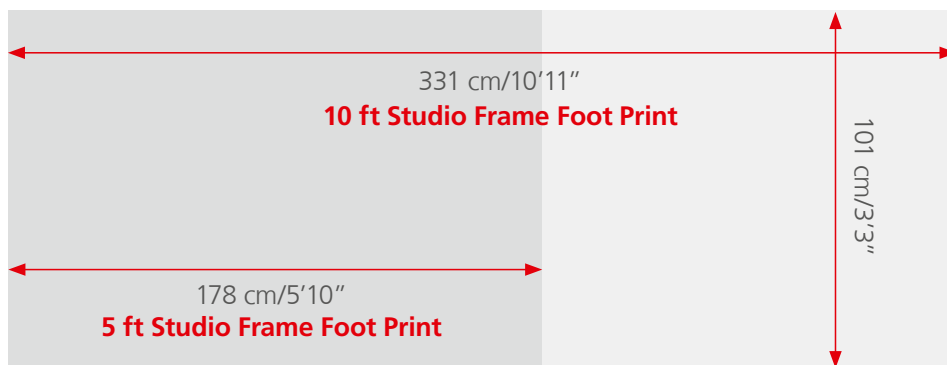

Dimensions

- Frame length (10 ft): 10'11"
- 10 ft frame can be set up as a 5 ft frame if desired
- Frame width: 3'3"
- Adjustable working height 35" to 44"
- Wide range of optional accessories

*Not available in all markets.



SET YOUR IMAGINATION FREE, BIG-TIME.

The BERNINA PRO Frame is ideal for larger projects because there are virtually no limits to what you can do. Not only are you freed up from having the weight of the quilt on your shoulders, you also have the option of automation*, which opens up a whole new world of possibilities. You have pantograph as a possibility. You have the Q-matic* as a possibility. You have a hydraulic lift as a possibility. The possibilities are virtually endless. All you need is the space to make it happen.

A BERNINA frame also frees you from all that pin basting. Seriously. As you move down the frame, the rollers are keeping the quilt straight, basting the sides as you approach a new area. The result? You can complete your project faster, and with the greatest of ease. You just mount the quilt on, make sure it's square and start quilting. Once you test drive a Q 20 or Q 24 on frame, you'll see just how freeing it is.

Big projects. Big Possibilities.

PRO Frame	Large PRO	Classic PRO	Small PRO
Size (length & depth)	12'11" x 3'11" 3.93 x 1.2 m	11'11" x 3'11" 3.63 x 1.2 m	8'10" x 3'11" 2.7 x 1.2 m
Maximum quilt size	ca. 120" ca. 3.05 m	ca. 108" ca. 2.74 m	ca. 71" ca. 1.8 m
Leaders	132" / 11' 3.36 m	120" / 10' 3.07 m	83" / 6'11" 2.12 m
Adjustable frame height	35" - 47" 0.9 - 1.2 m	35" - 47" 0.9 - 1.2 m	35" - 47" 0.9 - 1.2 m
Number of legs	6	6	4
Hydraulic Lift	optional	optional	optional

*Not available in all markets.



WHICHEVER SIZE YOU CHOOSE, THIS FRAME HAS IT ALL:

- Adjustable foot pads for perfect levelling
- Continuous X- and Y-axis track system with no joints
- Angled tracks and wheel axles for accurate and smooth movement of the sewhead to allow even quilting
- Friction-free 16-wheel system
- Leg system for maximum stability
- Multi-step ratchet system for perfect fabric tension
- Integrated latch system for maximum fabric holding power, yet easy release
- Pivot pick-up of magnetically secured top rail to smooth batting
- Dead bar for perfect fabric height no matter the length of your quilt
- Large diameter rails eliminate rail flex when tensioning the quilt
- Heavy duty canvas leaders with positioning markings for years of quilt loading ease
- Spacious pantograph tabletop to easily align your rolled patterns
- 4 bungee clamps to align every quilt to perfection
- Convenient trays for your longarm quilting tools

Spread your wings and fly! BERNINA designed the Q 24 and Q 20 on the BERNINA PRO Frame to provide optimum flexibility when working on larger projects.



READY, SET, AUTOMATE.

All it takes is a few simple steps, and the BERNINA Q-matic Longarm Quilting Automation System* is set into motion. A BERNINA exclusive, this state-of-the-art system for automated quilting performs all the tedious tasks, freeing you up to bring your creative vision to life. It's the perfect accompaniment to the Q 24, Q 20, and Q 16 PLUS on frames.

Not only can you work on any pattern of any size at any angle, the Q-matic also delivers a perfect design

first time, every time. Now planning out every detail of your quilt is a breeze. You can stitch out simple edge-to-edge designs or intricate custom patterns. And you can do automated or free-motion quilting. You can also combine digitized designs with free-hand work. The multiple on-demand help functions will assist you in every step of creating and placing your quilting designs. The power to create what you want, how you want is in your hands.

So many features. So many ways to create.

- One-touch quick belt release system
- Simple switch between automated and free-motion quilting
- Compact belt drive system
- All-in-one touch screen with WiFi connectivity
- Sewhead interaction functions
- More than 650 designs included
- Import .bqm and .dxf file formats
- Art & Stitch quilt design and digitizing software included
- Q-matic available for both the BERNINA Studio and PRO Frames

*Not available in all markets.

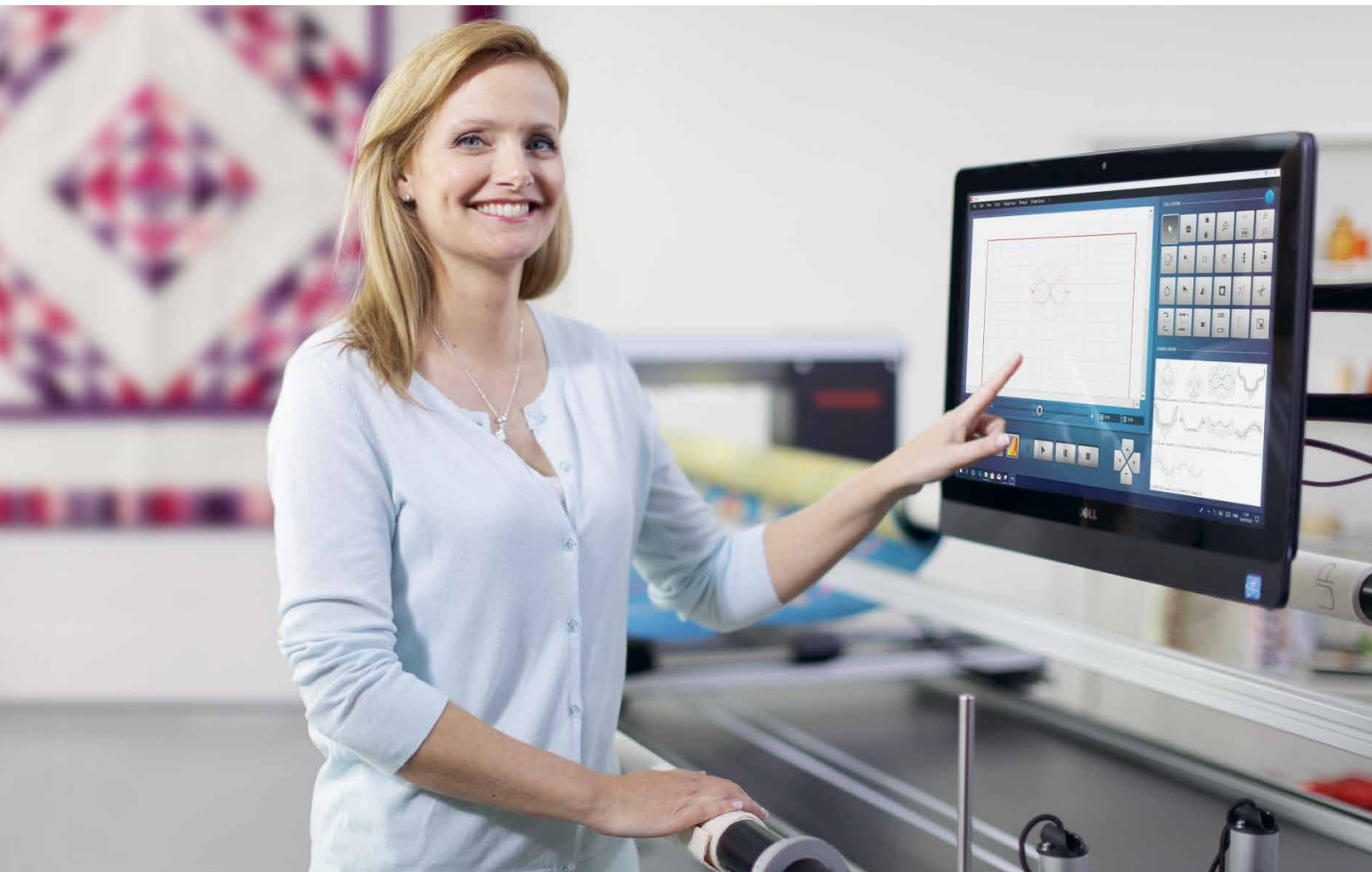

MAXIMISE THE MAGIC WITH THESE AMAZING Q SERIES FRAME ACCESSORIES.

From enhancing ergonomics to preparing and positioning your quilt to mastering creative designs, the right accessories can take a quilting project from great to A-M-A-Z-I-N-G. And since BERNINA accessories can be added whenever you're ready, you can continue to take your quilted creations to new and exciting places.



Pantograph Kit

Includes everything you need to easily stitch beautiful edge-to-edge designs.



Ruler Work Kit

Use with a wide range of rulers for precise straight quilting & specialty shapes.



BERNINA Ruler Kits

Used with Adjustable Ruler Foot #72, #72S and #96.



Frame Casters

Use with BERNINA PRO Frames for easy moving and repositioning of the frame.



Mechanical Channel Locks

Mounted directly to the frame and carriage so it's easier for you to sew straighter, more precise lines.



Zippered Leaders Supplementary Kit

Contains three additional zipper parts for the take up, back, and top rails.



Hydraulic Lift

Adjusts frame height with just the touch of a button.



Additional Shelving

Extra storage for accessories underneath PRO Frame.



Batting Rail/Roll Holder

Can be used on BERNINA Frames to conveniently store batting.



Leaders for 5-foot Studio Frame

Made to attach the quilt to the 5-ft setup of the BERNINA Studio Frame.



Zippered Leaders

Allows to pin or baste fabric to the removed leader edge from another location, making it easy to switch projects.



Palm Precision Handles

Mounted directly onto head for comfortable, controlled handling of the machine. Perfect for micro stippling.

GET THE MOST OUT OF YOUR Q SERIES LONGARM MACHINE. ACCESSORIES FOR THE LONGARM QUILTING MACHINE

These exceptional BERNINA Accessories work beautifully with your Q Series Frame or Sit-down machine.



Darning Foot #9 **Multi-purpose hopping foot**

Perfect for free-motion quilting, this foot comes standard with all BERNINA Q Series machines.



Embroidery Foot #15

Slight upward sole is recommended for appliqué and free-motion quilting.



Free Motion Embroidery Foot #24

The open sole design is great for appliqué and free-motion quilting.



Drop-Shaped Embroidery Foot #26

Recommended for dense quilting such as thread painting.



Quilting Foot #29

Perfect for free-motion quilting where there's filler designs and embellishments.



Free-Motion Couching Foot #43

Designed for appliqué with cords, yarn and ribbon up to 2mm in diameter.



Echo Quilting and CutWork Foot #44C

Good for echo & shadow quilting, free-motion quilting, thread painting and automated quilting.



Adjustable Ruler Foot #72

Lets you sew along rulers.



Adjustable Ruler Foot with Slit #72S

Lets you sew along rulers and quickly change to an open free-motion foot.



Adjustable Stippling Foot #73

Open toe simplifies free-motion quilting for small designs and detail work.



Adjustable Gliding Cup Foot #74

For free-motion, echo and shadow quilting, it aids in quilting around dimensional elements.



Ruler Foot #96

Free-motion foot used primarily in combination with ¼" templates of acrylic glass.



Echo Quilting Clips

Use with Adjustable Ruler Foot #72S and #96 to create echo quilting patterns.



Couching Inserts

Use with Adjustable Ruler Foot #72S for yarn, cord, wool and felt couching & metallics.



Twin Needle Stitch Plate

Easily clips into place for decorative sewing with size 3 mm or 4 mm twin needles.



Cup Clip

Use with Foot #96 for quilting over thicker seams, embroidery motifs or appliqués, it's ideal for pantograph and Q-matic.

Silicone Fluid Thread Lubrication Unit

is recommended when working with metallic and loosely twisted threads.



Needle Point Laser

Enables you to accurately place the needle without guesswork or using the handwheel.

Oil Pen Use regularly to ensure your longarm quilting machine runs smoothly.

USB Stick For storing data, quilt patterns and updated files.



Vertical Spool Holder

Gives you extra space for your favourite threads.

ACCESSORIES FOR THE Q SERIES TABLES

Gripper Rings give you more control while quilting, and help provide precise guiding.

- Flat and wrinkle-free quilting
- Set includes 8" and 11" gripper ring



Dust Cover

Ideal for protecting your machine from dust when not in use.

- Compatible with Q 20, Q 16 PLUS and Q 16



Ruler Kits

Contain rulers with different templates that vary in size and style.

- Easy and accurate ruler work
- Use with Adjustable Ruler Foot #72, #72S and Ruler Foot #96





FROM THE VERY FIRST STITCH, YOU WILL APPRECIATE THE THOUGHT BEHIND EVERY DETAIL.

We know the decision to own a longarm is no small thing. That's why we take the creating, engineering and manufacturing of each and every one of our longarm machines very seriously. We aren't just selling longarms. We're adding members to our family. A family that's been dedicated to making perfect stitches since 1893.

made to create **BERNINA**

Not all models and accessories are available in all countries. We reserve the right to make changes to machine features, equipment and design. Additional information available at your local BERNINA store.

BERNINA recommends threads from

Mettler[®]