

SEWING, EMBROIDERY & QUILTING 2019/2020

THE ENTIRE RANGE OF SEWING MACHINES AT A GLANCE



TIFFANY PRATT
DESIGNER



made to create **BERNINA**

1893

Karl Friedrich Gegauf, the founding father of BERNINA, invented the hemstitch sewing machine. This machine could sew 100 stitches a minute, causing a great sensation.

1928

His son Fritz Gegauf took over the factory in Steckborn in Switzerland. He was an engineer through and through whose ideas shaped the company and whose inventions are still in use today.

1932

Fritz invented the first household sewing machine and named it after his favourite mountain in the Eastern Alps in Switzerland – Bernina. And not only that! He then changed the name of the whole company from Gegauf & Co. to BERNINA.

1938

Under Fritz's direction, the first zigzag sewing machine from BERNINA came onto the market.

1954

Another important milestone occurred: BERNINA launched the first machine with the patented clip-on presser foot and buttonhole sewing function onto the market.

1963

Fritz's daughter, Odette Ueltschi-Gegauf, took over the company and brought out a sewing machine with a novel presser foot lifter. The Free Hand System, which raises the presser foot via a knee lifter, is still an important feature of almost every BERNINA today.

1971

A BERNINA with electric foot control followed, and in 1982 the first model with the stretch stitch function came out.

1988

Hanspeter Ueltschi, great-grandson of the company's founder, took over the company from his mother Odette and still manages BERNINA today. Under his leadership, BERNINA has developed into an iconic brand among passionate quilters throughout the world.

1990s

BERNINA made further important innovative leaps, culminating in the launch of the world's first sewing computer with a Microsoft Windows operating system in 2002.

2012

The patented BERNINA Hook was born – an amazing innovation from our Swiss engineers. It combines all the advantages of the world's previous two best hook technologies and is currently part of the new 4, 5 and 7 Series.

2015

BERNINA went into a new line of business, with two completely new longarm quilting machines including frames.

2017

New embroidery functions were launched by BERNINA on the new 5 Series, the B 790 PLUS and the B 880 PLUS. And BERNINA will continue to be a family-run business in the future as the 5th generation are already at work.

2018

BERNINA celebrated an important anniversary. It was 125 years since the company was founded by Karl Friedrich Gegauf – a very special year! To celebrate, BERNINA brought special limited-edition models with a gold faceplate on to the market, as well as two real gold-plated presser feet and a golden anniversary box.

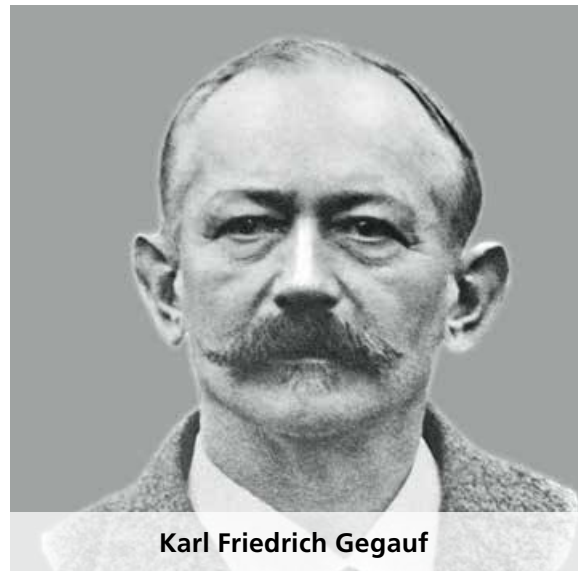

WE ARE A SWISS FAMILY BUSINESS

BERNINA has stood for Swiss tradition since 1893. BERNINA was founded by my great-grandfather, the inventor of the hemstitch sewing machine. The corporate philosophy has remained the same over the years: we strive for the highest quality workmanship and want to offer our customers an incomparably good sewing experience.

Sewing is about making something individual, something beautiful. The focus is on individuality, regardless of whether sewing, embroidering or quilting. But the do-it-yourself trend is also a trend towards sustainability, as many people see sewing as a conscious alternative to buying cheap clothes. This is in line with our philosophy, because BERNINA sewing machines are high-quality products that can be used to make equally high-quality items.

With our products, we appeal to sewing experts and novices alike, because both groups have high quality standards and a passion for textiles. Caring for our customers is a top priority for us. Training our retailers is therefore very important to us, so that they can provide expert advice and information about new products and maintain our machines.

Around the globe, there is great enthusiasm for BERNINA, and the feedback is positive. For me, this enjoyment and loyalty is the most beautiful incentive and the greatest motivation.



Sincerely,
Hanspeter Ueltschi,
Owner of BERNINA



CONTENTS

The entire BERNINA product range at a glance	4-5
Exclusive Features and Innovations	6-7
BERNINA Hook	8-9
BERNINA 880 PLUS	10-15
BERNINA 7 Series	16-23
BERNINA 5 Series	24-29
BERNINA 4 Series – NEW	30-33
BERNINA 3 Series – NEW	34-37
BERNINA 1008	38-39
BERNINA Embroidery Software 8	40-43
BERNINA Toolbox embroidery software	44-47
BERNINA DesignWorks	48-51
BERNINA Q20/Q24 Longarm Quilting Machines	52-53
Features	54

ULTIMATE SEWING, EMBROIDERING AND QUILTING



CUTTING EDGE OF SEWING AND EMBROIDERY







THE CLEVER SEWING EXPERTS



THE CREATIVE PARTNERS



THE ENTIRE BERNINA PRODUCT RANGE AT A GLANCE

 Embroidery  Embroidery-enabled  Quilting  Sewing



THE STYLISH, COMPACT MACHINES



EXCLUSIVE FEATURES AND INNOVATIONS

The BERNINA name has always been synonymous with robustness and durability. Quality is evident in the precision of the stitches and the high needle penetration power when sewing thick fabrics. A wealth of exclusive and innovative functions and features and simple, intuitive operation sets BERNINA sewing machines apart from all others.

TYPICALLY BERNINA

SMART SCREENS

Almost all BERNINA models feature a touch screen or an LCD display that lets you keep track of your settings at a glance.

LARGE SEWING AREA

Attaching the freearm slide-on table to any model increases your sewing area, making it significantly easier to sew projects such as curtains, evening dresses, trouser hems and pockets.

FREEARM EMBROIDERY

Closed items, such as T-shirts, can also be embroidered. Different sizes of embroidery hoops are available for different garments.

PERSONAL PROGRAM

The default settings of the stitches can be customised and saved, making it easy to select your favourite settings whenever you want.

PERSONAL MEMORY

The current stitch settings in each case are retained when switching between different applications.

ON-SCREEN BUTTONHOLE MEASURING SYSTEM

Simply hold the button to the screen and measure its diameter. The length of the buttonhole is automatically set and the buttonhole can be sewn as many times as wished.

BERNINA HOOK

The centrepiece of the BERNINA 4 Series, 5 Series and 7 Series allows you to sew precisely and quietly with a stitch width of up to 9 mm, for even longer stretches without interruption.

BERNINA ADAPTIVE THREAD TENSION

This innovation from BERNINA on the 4, 5 and 7 Series ensures the ideal thread tension as you sew, helping you to achieve

outstanding stitch quality on both sides of the fabric. After you set the thread tension for the thread and fabric, the BERNINA Adaptive Thread Tension continuously checks it as you sew, adjusting it unobtrusively and automatically whenever necessary. The result: the finest sewing and embroidery quality, with no need to even press a button!

STITCH DESIGNER

The BERNINA 880 PLUS and 790 PLUS come with the BERNINA Stitch Designer – an exceptional, innovative feature that lets you create your own stitches by drawing your ideas right on the touch screen. At the touch of a button, your design is converted into a stitch pattern. Built-in stitches can also be changed as desired. Add your custom-made stitch patterns to the stitch library for an even wider selection.

BERNINA DUAL FEED

The BERNINA Dual Feed is especially helpful when sewing delicate materials. When activated, the Dual Feed feeds the material from both the top and bottom, letting you sew difficult fabrics evenly and carefully.

TOTAL STITCH CONTROL

Permanent or temporary altering of length, width and needle position of all stitches – even while sewing.

BERNINA STITCH REGULATOR (BSR)

The revolutionary presser foot for even stitch length in free-motion sewing. Effortlessly create beautiful, consistent straight or zigzag stitches.

CREATIVE CONSULTANT

The Creative Consultant displays the appropriate presser foot, presser foot pressure, needle, and feed-dog position, as well as automatically setting thread tension and the desired stitch.

EMBROIDERY CONSULTANT

The embroidery consultant chooses a sample motif for the desired application and helps with the choice of needle, foot, hoop and backing.

BERNINA PRESSER FEET

BERNINA feet are unique as both the shafts and soles of BERNINA presser feet are made of solid metal. Sitting firmly in their mounting and thus remaining absolutely still during sewing, they contribute decisively to BERNINA's outstanding stitch quality. More than 70 feet, including some for special applications such as the BSR foot or the punching set, make the process of sewing, embroidery and quilting easier and open up new creative opportunities.

BERNINA FREE HAND SYSTEM (FHS)

The knee lever lowers the feed dog and raises the presser foot simultaneously so that both hands are free to guide and manoeuvre the fabric.

PINPOINT PLACEMENT

Accurately place embroidery designs with Pinpoint Placement, a great new feature for easy positioning and alignment.

INVISIBLE & SMART SECURE WITH INDIVIDUAL CUTTING

The Smart Secure function conveniently adds tie-on/off stitches to a design if none are pre-programmed. And the Invisible Secure makes the tie-on/off formation completely invisible. The cutting of jump stitches at every length can be set individually.

BERNINA DESIGNWORKS

Consisting of three modules, this software suite makes it easy to design and cut out patterns and shapes, paint colourful designs, and create custom designs with crystals.

AUTOMATIC HOOP RECOGNITION

Automatically recognises the embroidery hoop used as soon as it is fitted onto the embroidery module on the sewing machine, and adjusts the maximum embroidery area accordingly.

AUTOMATIC FOOT LIFTER

The automatic foot lifter automatically lowers the foot when you start sewing and raises it at the touch of a button.

AUTOMATIC PRESSER FOOT PRESSURE

The automatic presser foot pressure feature ensures that the presser foot has the ideal pressure for the selected stitch. The default setting can be adjusted for specific materials.

AUTOMATIC THREAD CUTTER

The automatic thread cutter trims the thread and lifts the needle and presser foot with just the touch of a button.



BERNINA HOOK

THE BERNINA **INNOVATION**

With up to 9 mm stitch width, the patented BERNINA Hook makes it possible to sew even longer segments without stopping. It has a centrally positioned driver which allows it to run especially quietly and evenly. It sews and embroiders with highly precise stitches and with a speed of up to 1000 stitches per minute. The BERNINA Hook's jumbo bobbin holds up to 70% more thread than standard bobbins. This way, a full spool can provide even longer periods of sewing and embroidering without interruption. The BERNINA Hook is made from extremely high-quality materials. Special polishes ensure a smooth thread path and guarantee an optimal and consistent thread tension.



**“The most
dependable machine
on earth.”**

TULA PINK, QUILTER AND FABRIC DESIGNER

**“MY BERNINA
NEVER LETS ME DOWN.”**

- PERFECT STITCHES
- MORE POWER – LESS NOISE
- BUILT STRONG – BUILT TO LAST
- QUALITY TO ITS CORE





THE ULTIMATE SEWING MACHINE

The ultimate in sewing technology: The BERNINA 880 PLUS is the queen of BERNINA sewing and embroidery machines. It features a huge selection of stitches, stitch patterns, lettering and embroidery designs, as well as the most modern software and sophisticated functions. Ease effortlessly into your work with the automatic threading system, the BERNINA Stitch Regulator and the BERNINA Dual Feed, and enjoy the needle penetration power when working with thick materials, the high speed and the extra large working area. Innovations such as the Colour Wheel, Shape Designer and Stitch Designer assist users in creating their own designs and stitches. The new BERNINA 880 PLUS is the perfect machine for those with a passion for sewing, embroidery and quilting.

8 THINGS YOU'LL LOVE:

- 1 **BERNINA Stitch Regulator (BSR)**
- 2 **Extended Freearm**
- 3 **Jumbo Bobbin**
- 4 **BERNINA Dual Feed**
- 5 **Fully Automatic Features**
- 6 **Extensive Stitch and Design Library**
- 7 **Total Stitch Control**
- 8 **Endless Embroidery Options**



BERNINA STITCH REGULATOR (BSR)

The BSR is designed to assist you in mastering free-motion techniques by keeping stitches consistent at variable sewing speeds. The BSR offers confidence for the beginner and additional assurance for the experienced quilter. Coming as standard with the B 880 PLUS, the BSR provides high-speed free-motion stitching assistance with both straight and zigzag stitch options.

EXTENDED FREEARM

The B 880 PLUS includes a meticulously engineered extended freearm area with a full 12 inches (30 cm) of space to the right of the needle and 5 inches (12 cm) in height. With this extra-large area, you have the added benefit of a very large embroidery field, an extended space in which to expand your creativity.

JUMBO BOBBIN

The unique Jumbo Bobbin featured on the B 880 PLUS offers up to 70% more thread capacity and pops in and out at the touch of a finger. That means fewer interruptions, fewer stops to wind your bobbin and a lot more time to set your imagination free.

BERNINA DUAL FEED

Optimum visibility. Superb manoeuvrability. The innovative BERNINA Dual Feed tames hard-to-manage fabrics. It's easy to engage when needed and tucks completely out of the way when it's not.

FULLY AUTOMATIC FEATURES

Imagine a machine that automatically responds to your needs. The presser foot lowers at the start of a seam and lifts again at the end. The B 880 PLUS will even cut the thread for you at the end of a seam or with a colour change in embroidery. The feed dog raises and lowers automatically for free-motion stitching and embroidery. And of course, fully automatic threading is yours at the touch of a button.

EXTENSIVE STITCH AND DESIGN LIBRARY

The BERNINA 880 PLUS includes a library of over 1700 stitches, conveniently stored by category for a wide variety of applications. You'll find the perfect stitch for every sewing project. Over 462 high-quality embroidery designs, including motifs by well-known designers, and 11 font styles are perfect for personalising your projects.

TOTAL STITCH CONTROL

The B 880 PLUS provides an exclusive level of stitch control. Whether altering the stitch length, stitch width or needle positions, or even creating custom combinations with drag-and-drop functionality, you'll appreciate the convenience of a machine that remembers the stitch details for you.

ENDLESS EMBROIDERY OPTIONS

The B 880 PLUS offers even more features and possibilities for embroidery lovers. The motif editing function allows you to position, mirror, rotate, combine and resize embroidery designs with ease. Create curved lettering effects, adjust the stitch density and incorporate decorative stitches into embroidery designs. Automatically colour-sort complex combinations, preview alternative colour combinations on screen using the Colour Wheel, and save everything to your machine or a USB stick. Would you like to embroider borders? The Endless Embroidery function guides you through the process. And finally, the Absolute Check feature helps you position your design precisely before embroidering.





EMBROIDERY AT THE HIGHEST LEVEL WITH THE B 880 PLUS

The B 880 PLUS has exceptional new functions to make embroidery even easier. In addition, it is compatible with all common file formats and has an integrated Embroidery Consultant, which helps you choose the right presser foot, the best needle and a suitable stabiliser for the fabric you are using.

Have you placed the fabric in the hoop at the wrong angle? No problem. With the Pinpoint Placement function, you can position your design on the fabric exactly where you want it – quickly and precisely, even if the fabric has not been placed straight. There's no need to use the template any more.

Do you want to embroider the pattern as it was before? No problem. With Undo & Redo, you can easily undo or redo changes made while editing an embroidery design.

The Group & Ungroup function helps you to edit multiple motifs. Group objects to edit them all at the same time, or ungroup them to edit objects individually. You can also adjust the layers of the embroidery sequence individually.

Manual trimming of jump stitches on the top side of the fabric is also a thing of the past. Jump stitches are cut automatically and thread tails are located on the underside of the fabric for fabulous looking embroidery on the top. The cutting of jump stitches can be set, subject to design properties.

The B 880 PLUS is also smarter than ever! You'll achieve brilliant embroidery results thanks to the new Invisible Secure function which makes the enhanced tie-on/off formation completely invisible. The Smart Secure function adds tie-on/off stitches to a design if none are pre-programmed. Or, simply turn this function off to keep the original tie-on/off stitch settings of the design.



BERNINA 880 PLUS

UNIQUE

STITCH DESIGNER

Create your own stitches with the Stitch Designer function. Draw your ideas directly on the touch screen and the B 880 PLUS converts the design into a stitch pattern. You can also alter existing stitches in the same way, thereby continually expanding your stitch library.

SHAPE DESIGNER (PATTERN CONFIGURATION)

The Shape Designer allows you to reproduce embroidery designs and reconfigure them with a single click. In combination with mirror-image effects, you can produce brand-new and unusual designs.

COLOUR WHEEL

The Colour Wheel function lets you preview embroidery designs in various colours before you begin. This allows you to choose the most beautiful colours for your embroidery project.

FREE INSTRUCTIONS AND PATTERN DOWNLOADS
FOR THE BERNINA 880 PLUS AT
BERNINA.COM/8SERIES

Speed control:

with a maximum speed of 1200 stitches per minute (spm) when sewing and 1000 spm when embroidering

BERNINA
Dual Feed

Endless Embroidery:

Borders, sewing stitches, basting function, freearm embroidery

Embroidery module

with extra-large embroidery area of 15.7" x 10.2" (400 x 260 mm)



The B 880 PLUS is BERNINA DesignWorks-compatible.

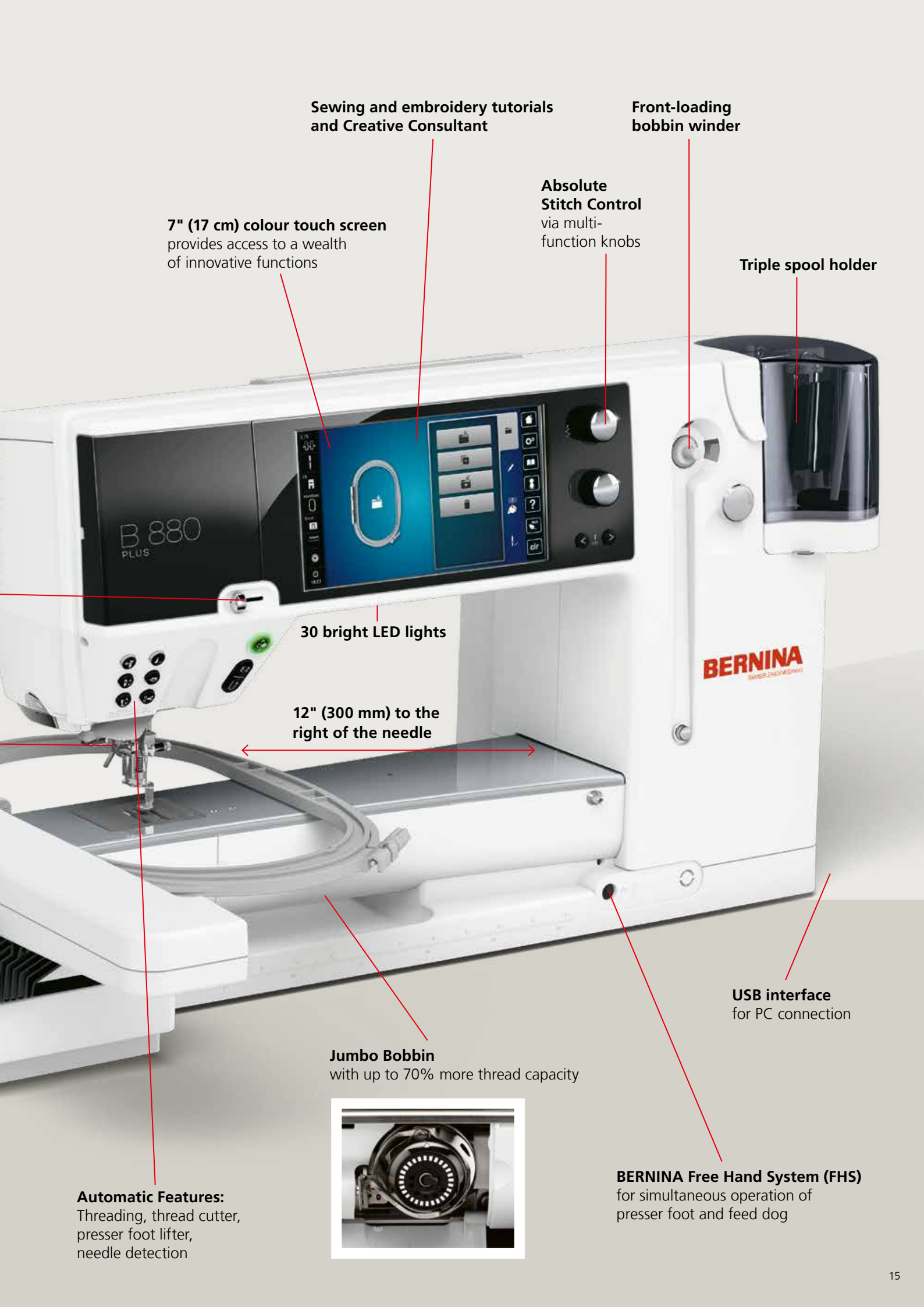

Sewing and embroidery tutorials and Creative Consultant

Front-loading bobbin winder

7" (17 cm) colour touch screen provides access to a wealth of innovative functions

Absolute Stitch Control via multi-function knobs

Triple spool holder

B 880 PLUS

30 bright LED lights

BERNINA
SWISS ENGINEERING

12" (300 mm) to the right of the needle

USB interface for PC connection

Jumbo Bobbin with up to 70% more thread capacity



Automatic Features: Threading, thread cutter, presser foot lifter, needle detection

BERNINA Free Hand System (FHS) for simultaneous operation of presser foot and feed dog



**“Working with a BERNINA
has an inspirational effect
on my designs.”**

MATHIAS ACKERMANN, SWISS DESIGNER

Creating his first designs when he was still a child, Mathias Ackermann realised from an early age that he wanted to make his passion his career. As a tailor and fashion designer, he still sews all his designs himself. Since 1997, Ackermann has worked in his own couture studio in Büren an der Aare in Switzerland. The first shirt collection of his “Little Kingdom” label was presented in February 2006 in Zurich at Globus, a leading department store with an exclusive range. In the same year, he was nominated for the Swiss Fashion Award. BERNINA is delighted to be able to work with this talented Swiss textile artist.

LEADING THE WAY IN SEWING AND EMBROIDERY

The BERNINA 7 Series combines the finest technology with innovation and all the space you need. The extended freearm means that all models are suitable for your largest sewing or quilt projects. The B 790 PLUS is the sewing and embroidery professional of the 7 Series. The embroidery module can also be added to the B 720 and B 770 QE, making them sophisticated embroidery machines. The B 740, B 770 QE and B 790 PLUS feature an integrated Dual Feed ensuring even feed of smooth or fine materials. The unique BERNINA Stitch Regulator (BSR) can be used for effortless free-hand sewing on all models in the 7 Series (except the B 700). The centrepiece of the 7 Series is the BERNINA Hook. It sews precisely, quickly and quietly with a stitch width of up to 9 mm (B 740, B 770 QE and B 790 PLUS) or up to 5.5 mm (B 720). The BERNINA 700 is an embroidery-only machine with no sewing function and offers even more possibilities for embroidery lovers. In addition to the large embroidery module, three embroidery hoops and a multiple spool holder are included as standard.

THINGS YOU'LL LOVE ABOUT THE 7 SERIES:

- 1 **BERNINA Stitch Regulator (BSR)**
- 2 **BERNINA Dual Feed**
- 3 **Extended freearm for big projects**
- 4 **Total stitch and embroidery control**
- 5 **BERNINA Adaptive Thread Tension**
- 6 **Sew and embroider with even greater ease**
- 7 **Beautiful, easy and flawless embroidery**
- 8 **Creating stitches (790 PLUS only)**
- 9 **Invisible and smart securing in embroidery**
- 10 **Cutting of jump stitches**
- 11 **Pinpoint Placement (B 790 PLUS and B 700 only)**
- 12 **New embroidery features: Undo & Redo and Group & Ungroup (B 790 PLUS and B 700 only)**
- 13 **Help, Tips and Tricks**



BERNINA STITCH REGULATOR (BSR)

All models of the BERNINA 7 Series (except the B 700) are equipped with the BSR function. The BSR foot assists you with free-motion sewing and quilting with a straight or zigzag stitch, ensuring stitches of the exact same length even at variable sewing speeds. Beginners quickly gain confidence with the BSR, while experienced quilters acquire additional self-assurance. The BSR foot comes in the standard accessories package of both the B 770 QE and B 790 PLUS, and as an option for the B 720 and B 740.

BERNINA DUAL FEED

The innovative BERNINA Dual Feed (B 740, B 770 QE, B 790 PLUS) simultaneously feeds the fabric from above and below. Even slippery and delicate materials are fed evenly and carefully. Easy to engage when needed, the BERNINA Dual Feed tucks completely out of the way when it's not.

EXTENDED FREEARM FOR BIG IDEAS

The BERNINA 7 Series includes a meticulously engineered extended freearm with 10" (254 mm) to the right of the needle providing ample space for big, beautiful sewing and embroidery projects. The BERNINA embroidery module (optional for the B 720 and B 770 QE) lets you stitch out extra-large embroidery motifs.

TOTAL STITCH AND EMBROIDERY CONTROL

All the models in the BERNINA 7 Series offer the highest standard of total stitch and/or embroidery control. The stitch length, stitch width and needle position can be adjusted individually (except on the B 700). Personal settings can be saved and accessed at any time. And stitches and stitch patterns or stitch combinations as well as embroidery motifs can even be imported and exported via the USB port.

BERNINA ADAPTIVE THREAD TENSION

This innovation from BERNINA ensures the ideal thread tension as you sew, helping you to achieve outstanding stitch quality on both sides of the fabric. After you set the thread tension for the thread and fabric, the BERNINA Adaptive Thread Tension continuously checks it as you sew, adjusting it unobtrusively and automatically whenever necessary. The result: the finest sewing and embroidery quality, with no need to even press a button!

SEW AND EMBROIDER WITH EVEN GREATER EASE

The BERNINA 7 Series models carry out many tasks by themselves. The presser foot lowers automatically when you start sewing. Threading is semi-automatic and the thread is cut automatically when you reach the end of a seam or when you wish to change colours while embroidering. The standard package also includes a practical slide-on table that significantly increases your work area (except the B 700).

BEAUTIFUL, EASY AND FLAWLESS EMBROIDERY

The B 720, B 770 QE and B 790 PLUS can sew and embroider, the B 790 PLUS being our combined sewing and embroidery expert. The B 700 is an embroidery-only machine, with no sewing function. Designs can be positioned, mirrored, rotated, formatted and combined on all models. Motifs can also be edited, offering many additional possibilities: you can create curved lettering effects, alter the stitch density and combine decorative stitches or alphabets with embroidery motifs. Complex combinations can even be sorted by colour, and you can look at alternative colour options before embroidering. The finished design can be saved directly to the machine or onto a USB stick. The USB port also allows additional designs to be loaded onto the machine. The Absolute Check function helps position the design precisely before embroidering. The B 790 PLUS and B 700 come with the embroidery module as standard, while it is an optional extra on the B 720 and B 770 QE.



CREATE YOUR OWN STITCHES

The BERNINA 790 PLUS comes with an exceptional, innovative feature – the BERNINA Stitch Designer. It lets you create your own stitches by drawing your ideas right on the touch screen. At the touch of a finger, your design is then turned into a stitch pattern. Built-in stitches can also be changed as desired. Add your custom-made stitch patterns to the stitch library for a wider selection of stitches.

INVISIBLE AND SMART SECURING IN EMBROIDERY

You'll achieve brilliant embroidery results thanks to the new Invisible Secure function which makes the enhanced tie-on/off formation completely invisible. The Smart Secure function conveniently adds tie-on/off stitches to a design if none are pre-programmed. Or, simply turn this function off to keep the original tie-on/off stitch settings of the design.

CUTTING OF JUMP STITCHES

A big plus is that the cutting of jump stitches can be set, subject to design properties. No more manual trimming on the top side needed. Flawless embroidery has never been easier.

PINPOINT PLACEMENT (B 790 PLUS AND B 700 ONLY)

Accurately place embroidery designs with Pinpoint Placement, a great new feature for easy positioning and alignment. Simply select two points on the screen, match them with the markings on the hooped fabric, and have the design either aligned, rotated or resized to fit as desired. Have full visibility of the hooped fabric at all times, no additional tools or aids are needed.

NEW EMBROIDERY FUNCTIONS: UNDO & REDO AND GROUP & UNGROUP (B 790 PLUS AND B 700 ONLY)

You can simply undo or redo steps while editing or combining designs to return to your initial position. Combine designs to edit all at one time with group. Break apart designs to edit individually with ungroup. The design layer stitch-out sequence can also be customised.

HELP, TIPS AND TRICKS

With the BERNINA 7 Series, great importance is placed on userfriendliness and intuitive navigation. The Sewing and Embroidery Consultant offers direct on-screen support and answers to your questions, and the tutorial shows important work steps through short animated instructions. Should your ambitions grow simply upgrade your BERNINA 7 Series model with a wide range of accessories.



BERNINA 790 PLUS

FREE INSTRUCTIONS AND PATTERN
DOWNLOADS FOR THE BERNINA 7 SERIES AT
BERNINA.COM/7SERIES

Semi-automatic needle threader

BERNINA Dual Feed

Embroidery
module
with extra-large
embroidery area –
15.7" × 8.3"
(400 × 210 mm)

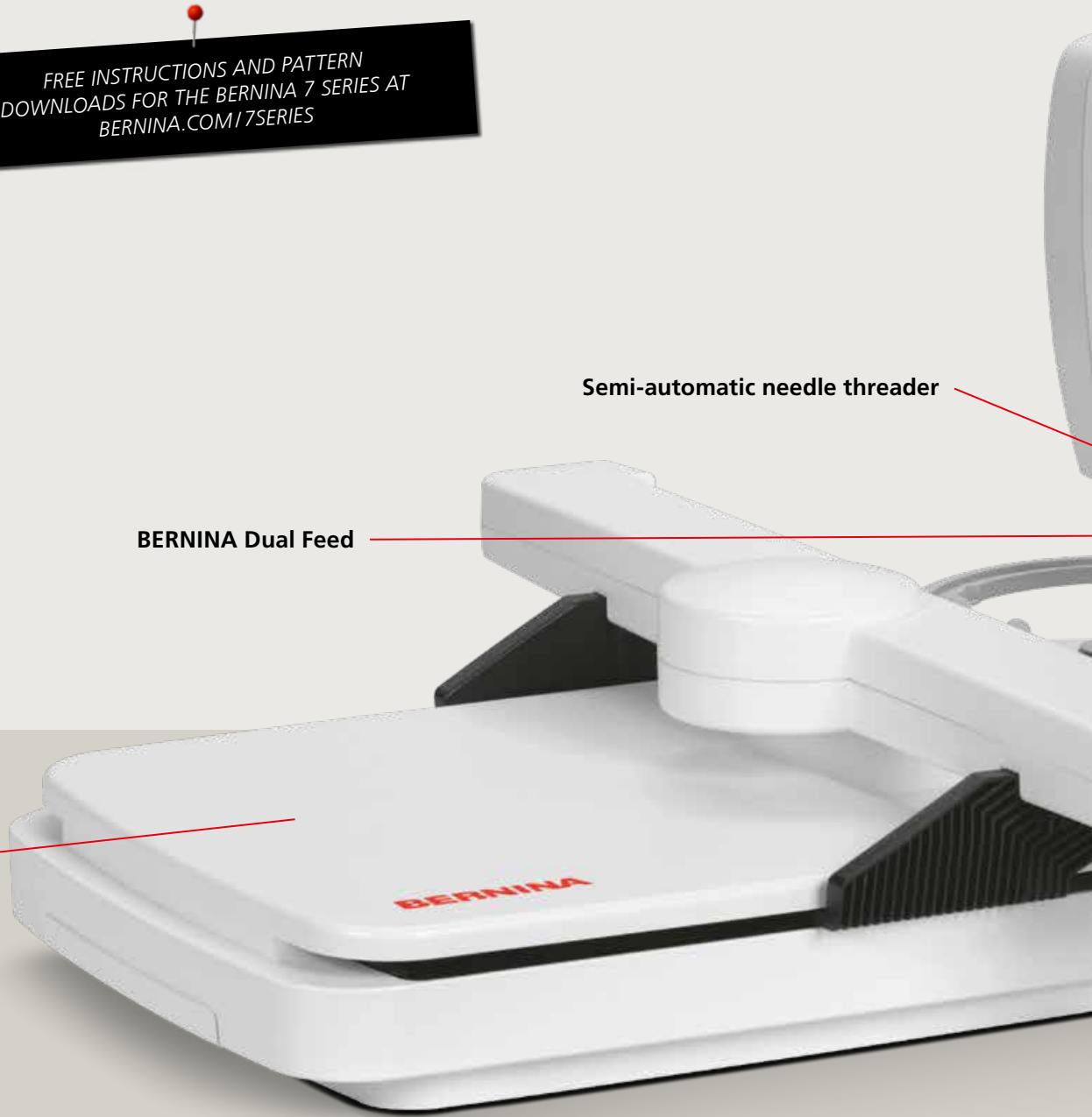

BERNINA 740*/720*



BERNINA 770 QUILTERS EDITION



All the models in the 7 Series are compatible with BERNINA DesignWorks.



* Not all models are available in all countries.





**“Next to my love for fabrics,
I’m equally passionate
about BERNINA.”**

TULA PINK, US FABRIC DESIGNER AND QUILT ARTIST

Tula Pink plays with images the way a poet plays with words, turning traditional designs into modern creations. Tula’s love for textiles began early and a passion for sewing soon followed. Tula began designing her own fabrics and started to quilt in an effort to use up her ever-growing stash of fabric. Today, many years later, she is a renowned designer and quilter. Tula Pink has designed a quilt from her “Moonshine” fabric collection exclusively for BERNINA.

“The freedom to create endless design combinations.”

YAYA HAN, COSPLAY ARTIST

EXPERTS ARE TALKING ABOUT US. AND WE COULDN'T BE HAPPIER.

Before we list all the innovative features that make this line great, we're going to let the sewing experts and quilters, creators and makers do a little of the talking for us. The thing is, they love the new 5 Series machines as much as we loved designing and engineering them at BERNINA in Switzerland. Because these makers and creators love their craft, they love perfect stitches, fast machines and convenient ways to do what they do best... create.



“The B 570 QE makes me feel like a pro.”

SUZY WILLIAMS, SUZY QUILTS, QUILT DESIGNER

If quilts tell stories, then Suzy's tell of how modern design met beautiful stitches and lived happily ever after! And the matchmaker in this tale is none other than the B 570 QE. It's made especially for quilters who want the very best. That's why Suzy loves it and you will too!



“Sailing or sewing – they both involve speed and precision.”

LIVIA NAEF & NELIA PUHZE,
SWISS SAILORS, SEWING ENTHUSIASTS

So what does a pair of sailors do between training sessions? Why, sew of course. Nothing relaxes Livia and Nelia more than the easy-to-use, powerful B 535 and B 540 for giving old sails some new life. You'll love these machine as much as they do!



***“You can go wild with
your imagination.”***

What does a wildly-talented cosplayer love about the B 590? Everything. It’s faster than her looming deadlines. It’s powerful enough for crazy materials. And its embroidery capabilities are absolutely amazing. Yaya loves this machine and so will you!





THE CLEVER SEWING EXPERTS

We have re-engineered the 5 Series especially for passionate creatives. These machines are the perfect size and have many advantages, such as the patented BERNINA Hook. The series is made up of five smart models which make sewing, embroidery and quilting even easier thanks to their practical features. Even the B 535 and B 540, the entry models in the series, are BSR-capable and can also embroider, so they can be upgraded as your requirements change. The B 570 QE, the Quilters Edition, is already equipped with the BSR foot as standard and it can also embroider. The all-rounder of the BERNINA 5 Series is the B 590, because this sewing and embroidery machine includes the embroidery module as standard. And if you only want to embroider, the B 500 is an embroidery-only machine with no sewing function. All the models are easy to operate via the large colour touch screen.



YOU'LL LOVE THESE FEATURES:

- 1 Total Stitch Control
- 2 BERNINA Stitch Regulator (BSR)
- 3 Jumbo Bobbin
- 4 Beautiful embroidery is easy thanks to new features
- 5 BERNINA Adaptive Thread Tension
- 6 Large choice of stitches and stitch patterns
- 7 Easy to use, with new features
- 8 Greater sewing ease and creativity
- 9 Room for your growing needs

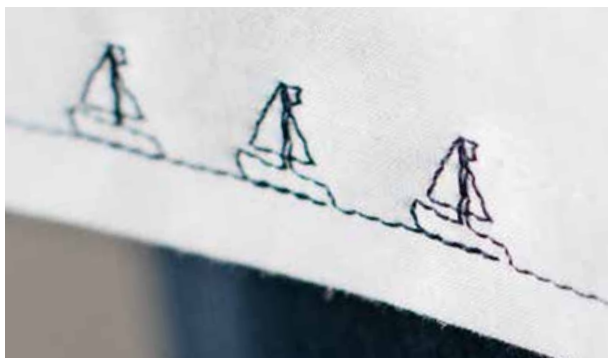

TOTAL STITCH CONTROL

Do you want to be fully in control of your creativity at all times? The models in the 5 Series give you complete freedom. All the stitch properties, such as the stitch width, stitch length and the 11 needle positions, can be set individually and temporarily saved. The needle position when you stop sewing can also be individually set to up or down. And the upper and lower thread indicators on the B 590, B 570 QE and B 500 automatically tell you if a thread breaks. You can control all of this at the touch of a button thanks to the large, intuitive touch screen.

BERNINA STITCH REGULATOR (BSR)

All models of the BERNINA 5 Series (except the B 500) are equipped with the BSR function. The BSR foot assists you with free-motion sewing and quilting with a straight or zigzag stitch, ensuring stitches of the exact same length even at variable sewing speeds. Beginners quickly gain confidence with the BSR, while experienced quilters acquire additional self-assurance. The BSR foot comes in the standard accessories package of both the B 570 QE and B 590, and as an option for the B 535 and B 540.

JUMBO BOBBIN

The Jumbo Bobbin is exactly as its name suggests: it holds up to 70% more thread than standard bobbins, resulting in significantly fewer sewing interruptions – especially during elaborate sewing projects such as large quilts. Another very convenient feature is that the bobbin is inserted from the front, so there is no need to remove your sewing.

BEAUTIFUL EMBROIDERY IS EASY THANKS TO NEW FEATURES

The automatic, Invisible Secure function for securing stitches ensures even more brilliant embroidery results. And the Smart Secure function adds securing stitches to an embroidery design if they are not already preprogrammed. The time-consuming manual trimming of jump stitches is also a thing of the past because 5 Series machines do this automatically. The Thread-up Command lowers and raises the needle bringing the bobbin thread to the top of the fabric so you can secure the threads manually. This leaves the underside beautifully thread-free. The practical Thread Away Mode is a swift movement of the hoop that pulls most of the upper thread tails to the underside for clean embroidery results on the top (B 590, B 570 QE and B 500 only).

BERNINA ADAPTIVE THREAD TENSION

This innovation from BERNINA ensures the ideal thread tension as you sew, helping you to achieve outstanding stitch quality on both sides of the fabric. After you set the thread tension for the thread and fabric, the BERNINA Adaptive Thread Tension continuously checks it as you sew, adjusting it unobtrusively and automatically whenever necessary. The result: the finest sewing and embroidery quality, with no need to even press a button!

LARGE SELECTION OF STITCHES AND STITCH PATTERNS

Outstanding selection: the B 590, B 570 QE, B 540 and B 535 contain hundreds of decorative stitches as well as up to nine sewing alphabets. The B 570 QE also has special quilting stitches, and with the Triple Stitch Function on the B 590 and B 570 QE, you can give your creations a wow factor. The automatic buttonhole gives buttonholes a professional touch. There are also lots of preloaded embroidery designs to choose from and you can upload your own embroidery motifs via the USB port and edit them on the touch screen. Rotate, mirror, resize or change the colour – whatever you want.

EASY TO USE, WITH NEW FEATURES

The user-friendly touch screen makes the 5 Series very easy to operate. All models allow design edits directly on the screen during embroidery. Rotate, mirror, combine and rearrange with a simple touch of the screen. The new Undo & Redo lets you easily go single steps back or forward while Group & Ungroup lets you edit all at once or individually. With the Pinpoint Placement feature, the precise positioning and alignment of embroidery motifs on the B 590 and B 500 is a breeze. And the Embroidery Consultant is there to help you if you have any questions, and provides valuable tips and advice (B 590 and B 500 only).

GREATER SEWING EASE AND CREATIVITY

The BERNINA Free Hand System (FHS) lets you operate the presser foot and feed dog simultaneously with a knee lifter, leaving both your hands free to guide the fabric. The slide-on table clicks easily into place providing space to spread out larger projects, and greater comfort and convenience when sewing. And the increased size of the working area, with 8.5" (215 mm) of space to the right of the needle, also allows you to manage larger quilts.

ROOM FOR YOUR GROWING NEEDS

A large range of accessories and presser feet made of robust solid metal are included as standard. As your requirements increase, the models can be enhanced with additional accessories for sewing, embroidery and quilting, such as the BSR foot if not already included. A practical accessory box in a modern design that can be attached to the machine easily with a magnet is also included.

BERNINA 590

FREE INSTRUCTIONS AND PATTERN
DOWNLOADS FOR THE BERNINA 5 SERIES AT
BERNINA.COM/5SERIES

Semi-automatic needle threader

Embroidery module
with 15.7" x 5.9"
(400 x 150 mm)
embroidery area

Automatic
thread cutter

12 bright
LED lights

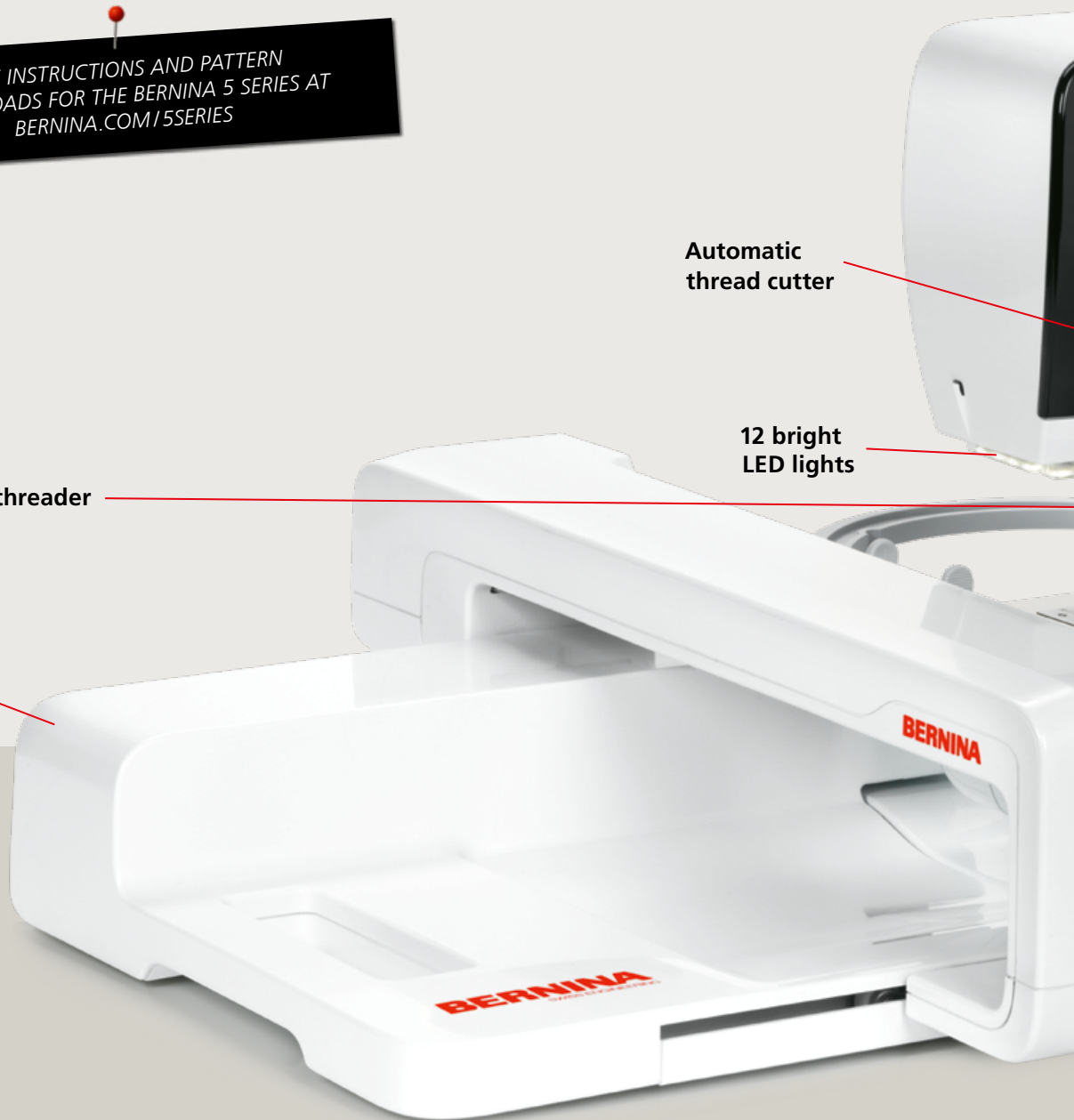

BERNINA 540*/535*



BERNINA 570 QUILTERS EDITION



All the models in the 5 Series are compatible with BERNINA DesignWorks.



* Not all products and models are available in all countries.

MADE FOR **MAKERS**

Making your sewing and crafting life easier and more enjoyable is what the 4 Series is all about. Innovative features automate tedious tasks. That means you are free to be the sewist, crafter, quilter, maker you have always wanted to be.

Who better to speak on behalf of our newly innovated 4 Series than the sewists, quilters and makers who do what they do best on these machines ... create. What could be better than loving the machine you create on. Our experts love the 4 Series machines because their innovative features make common sewing techniques easier, make creativity the rewarding experience it should be and make perfection possible. But don't take our word for it.

FOR THOSE WHO CREATE. THE NEWLY-ENGINEERED 4 SERIES. FEATURES, FEATURES AND MORE FEATURES:

- 1 Impeccable stitches with the BERNINA Hook
- 2 Powerful DC motor for thick materials
- 3 Fewer interruptions with the Jumbo Bobbin
- 4 Front-loading bobbin for easy access
- 5 Convenient automatic thread cutter (B 475 QE, B 480 & B 485)
- 6 7" right of the needle
- 7 Easy-to-navigate 4.3" colour touch screen
- 8 Adjustable presser foot pressure
- 9 Large selection of sewing stitches and alphabets
- 10 BERNINA Stitch Regulator functionality (B 475 QE, B 480 & B 485)
- 11 Creative sewing consultant for on the spot advice



**"The B 480 is an essential
part of my studio."**

**YVONNE REICHMUTH – "YVY",
SWISS FASHION DESIGNER**

Highly sophisticated. Brilliantly simple. Like Yvonne's beautiful designs, her B 480 expertly combines simple, easy-to-use features with innovative technology ensuring that her stitches are impeccable on everything from leather to delicate fabrics. Her machine exceeds her expectations. You can expect the same.

YOUR CREATIVITY. YOUR DECISIONS

Want to go where your creativity takes you without being limited? The 4 Series models let you make all the creative decisions. Like choosing the stitch length and width or deciding the needle position. If you want the needle down when it stops, you can. And all that control is conveniently located at your fingertips on the large, intuitive touch screen.

FRONT-LOAD JUMBO BOBBIN FOR MORE SEW TIME

Fewer stops and starts is the result of a bigger bobbin that holds up to 70% more thread than standard bobbins. And since it is conveniently changed from the front, there's no need to remove your project.

STITCHES PLUS LETTERS PLUS MORE OF WHAT YOU LOVE

When more options are what you want, a 4 Series machine is what you need. There's a huge choice of sewing and decorative stitches as well as alphabets. These machines offer over 150 to 250 decorative stitches and up to 5 alphabets. And the B 475 QE is full of special quilting stitches. The choices are many and every one of them yours.

EXCLUSIVE BERNINA ADAPTIVE THREAD TENSION

Achieve permanent control of the thread tension. Once it's adapted to the thread and fabric, the thread tension adjusts automatically while sewing. And the innovative BERNINA Hook keeps every stitch consistent and precise.

BERNINA HOOK INSIDE

The BERNINA Hook is the centrepiece of the BERNINA 4 Series. It's fast while also being quiet. It's efficient while housing a Jumbo bobbin. It's front-loading for convenient, fast changes and easy cleaning and oiling.

BERNINA FREE HAND SYSTEM (FHS)

The BERNINA Free Hand System lets you lift or lower the presser foot and lower the feed dog at the same time, using only the knee lifter and keeping your hands free to guide your projects. The knee lifter is standard on the B 485, B 480 and B 475 QE and optional on the B 435.

SIMPLE ON-SCREEN EDITING

Be as creative as you dare with your stitches by editing directly from the easy-to-navigate touch screen while you work. Simply tap the screen to choose your favourite stitches. Or maybe you want to combine different stitches. Or create a new look by extending your decorative stitches using Pattern Elongation (available on B 485 & B 480). Or create a custom pattern with Pattern Repeat.

SPECIAL QUILTING STITCHES

With 40 quilting stitches plus 29 utility stitches and 4 sewing alphabets pre-loaded and ready to go, the B 475 QE is well equipped for all your creative needs.

BERNINA STITCH REGULATOR – BSR (OPTIONAL)

The amazing BSR regulates impeccable equal-length straight and zigzag stitches at variable sewing speeds during free-motion quilting. BSR is optional for models B 475 QE, B 480 and B 485 and is not available on the B 435.



"You don't need to sew perfect, the machine will make it magic."

TIFFANY PRATT, DESIGNER AND MAKER

Talented. Energetic. Creative. Bold. A maker like Tiffany relies on the B 435 and B 475 QE to be powerful, easy to handle, fast and magical. Day in and day out. And her BERNINA never fails to deliver. She loves it and you will too.

MORE POWER, SPEED, PERFECTION AND EASE

Adjustable presser foot pressure

Adjusts for thick or thin fabric to eliminate skipped stitches

Easy access at the front

Automatic thread cutter (B 485/B 480/B 475 QE)

Saves time: it cuts the thread and raises the needle in one step

Easy threading

The semi-automatic needle threader makes threading super easy

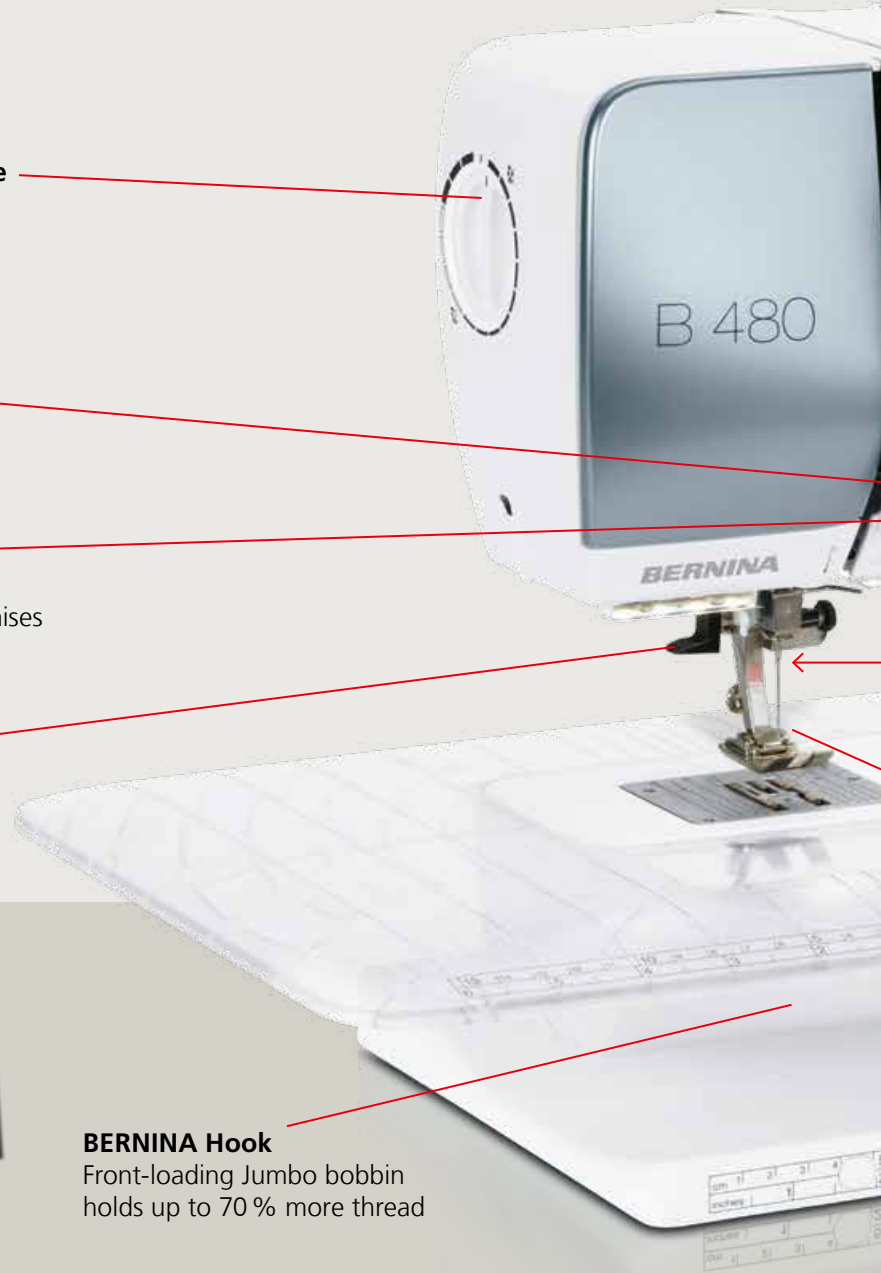

BERNINA Hook

Front-loading Jumbo bobbin holds up to 70 % more thread

FREE INSTRUCTIONS AND PATTERN
DOWNLOADS FOR THE BERNINA 4 SERIES AT
BERNINA.COM/4SERIES



BERNINA 480*/485*



BERNINA 475 QE

Variable sewing speed
Maximum speed of 900 stitches per minute

Modern, colour touch screen
Easy to use with simple navigation

Multi-function knobs
Stepless rotation, easy to operate

7" (177.7 mm) to the right of the needle

BERNINA
SWISS ENGINEERING

BERNINA Free Hand System (FHS)
Knee lifter is standard with B 485, B 480 & B 475 QE and optional with B 435

BERNINA Stitch Regulator (BSR) enabled (B 485 / B 480 / B 475 QE)

- Works with straight or zigzag stitch and with feed dog lowered
- BSR foot is optional



BERNINA 435



BERNINA 335 AND 325

YOUR NEW GO-TO MACHINES

Being a sewist, a maker, a creator is serious business. When it's time to make, your creativity deserves the support of a great team. Meet the B 335 and B 325 machines. Small enough to fit into any sewing nook or cranny, yet powerful enough to stitch through your toughest materials and ideas. Plus, they look as good as they sew. They are after all, BERNINAs.

QUALITY FROM TOP TO BOBBIN

It's hard to improve on awesome, but we've found a way! Our 3 Series machines are full of the latest technology and robust, durable quality ensuring nothing stands in the way of your creativity. On the outside, the simple, user-friendly operation makes your maker life easy. A bright modern LCD screen provides an overview of the function settings at all times. And the direct selection buttons allow quick access to all the functions.

CREATIVE DIY FANS ... DI-WHY NOT?

Whether you want to sew your own clothes, make unique accessories or just repair something, the B 335 and B 325 are always at your side. You can sew all kinds of fabrics and expertly finish or embellish your projects with decorative stitches. However you express your creativity, your BERNINA will bring it to life.

COMFORT COMES STANDARD

The most frequently used functions are easily accessible right up front, for example the start/stop button for sewing without the foot control or the reverse sewing button. The position of the needle when you stop sewing is set using the needle stop up/down button – incredibly helpful when sewing corners. The pattern end and mirror image (B 335 only) features, useful when sewing decorative stitches, are also located here. And with the slide speed control, set the speed you want, up to 900 stitches per minute.

GOOD THINGS COME IN SMALL PACKAGES

16cm (6.3 inches) to the right of the needle is plenty of room for your ideas, but hardly any space in your sewing room. And the freearm makes manipulating closed items, such as sleeves or trouser legs, particularly easy and convenient.



"I know I have a new best friend with the B 335."

ANNIKA VICTORIA, DIY LOVER AND YOUTUBER

Annika is young, talented, creative and crazy unique. The YouTuber from Sydney, Australia, knows exactly what her sewing fans want: uncomplicated patterns that are fun to sew. And, as her down-to-earth, you-can-do-it videos show, her BERNINA 335 is the go-to partner she can count on. She loves her BERNINA 3 Series. You will too!

BERNINA FREE HAND SYSTEM (FHS)

Raise or lower the presser foot while simultaneously lowering the feed dog – without having to take your hands off the fabric thanks to the BERNINA Free Hand System. The knee lever makes it possible! The FHS capability is built into the B 335 as standard with the knee lever optional. The FHS is not available on the B 325.

NICE AND CONVENIENT

The semi-automatic threader makes threading the needle simple and the bright LED sewing light lets you sew through the night. Direct selection buttons let you quickly and easily select the perfect stitch, which can conveniently be adjusted using the stitch width and length altering buttons. Individual stitch settings can then be saved in the memory, losing nothing. And usefully, you can monitor everything on the screen.

ALL-ROUND EXCELLENCE

With stitched lettering (sewing alphabet) and a large selection of decorative stitches, make your sewing projects as unique as you are. Save time with functions like the button sew-on program. Or find the space you need on the popular freearm extension table, which gives you more room around the presser foot and needle. The accessory package includes various presser foot soles; and the Buttonhole foot with slide #3A is included in the B 335 to sew automatic buttonholes. The 3 Series is easily upgraded with a wide range of optional accessories.

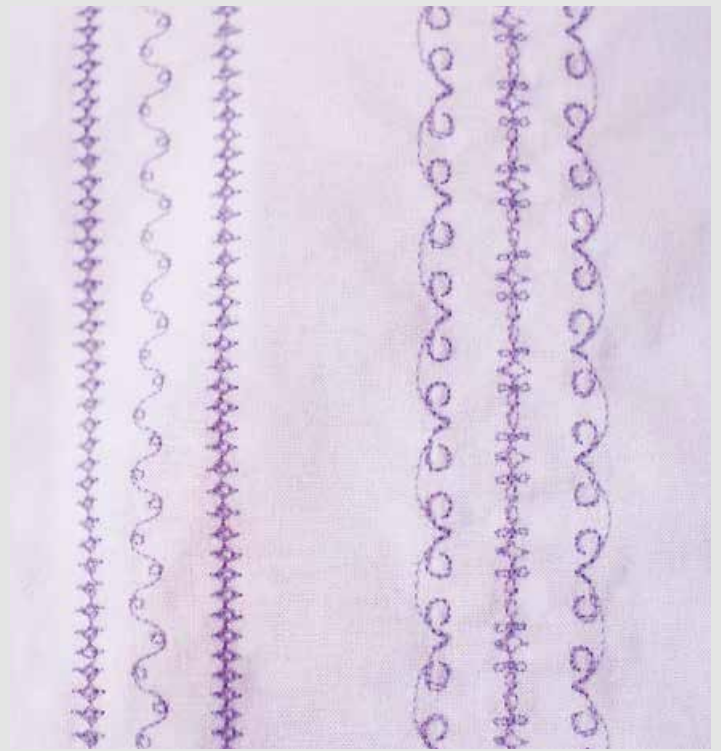

BERNINA 335



BERNINA 325

THE STYLISH ENTRY-LEVEL MACHINES

We have made our entry-level models in the BERNINA 3 Series – the B 335 and B 325 – even better: robust quality, user-friendly and easy handling, coupled with a chic design. Stylish sewing really is that easy!

Variable sewing speed
Up to 900 stitches per minute

Ergonomic
Easy-to-reach buttons:
Start/stop and reverse sewing

**Semi-automatic needle
threader**
Practical built-in threading guide



LEARN MORE ABOUT THE
BERNINA 3 SERIES
AT BERNINA.COM/3SERIES

LCD screen

Overview of all the settings

Convenient stitch adjustment

Stitch width, needle position and stitch length are easy to set with a button

Memory

Stitch settings are easy to save in the memory

Direct selection buttons

Quick, direct selection of different stitches

Built-in BERNINA Free Hand System (FHS)

Simultaneous raising of the presser foot and lowering of the feed dog with the knee lever (B 335 optional; B 325 not available)



THE CLASSIC MECHANICAL MACHINE

The legendary 1008 model has been popular for decades. The last purely mechanical sewing machine in the BERNINA range is extremely easy to use. It features infinitely adjustable stitch length and width, a slim freearm, drop feed dog and metal covers, all of which makes the 1008 your robust and reliable assistant for sewing garments, gifts, accessories and quilts.

Information at a glance:

Once you've selected your stitch, the Stitch Selection Chart lets you know the appropriate presser foot and needle position, as well as the best stitch length and width.



BERNINA 1008



Special features:

The width and length of all stitch patterns can be infinitely adjusted as required.

Versatile:

An especially slim freearm enables flawless sewing of children's clothing and tubular items such as sleeves, cuffs, collars and trouser hems.



Compatible with
Windows 7/8/10
and 4K monitors
Includes CorelDRAW
Graphics Suite SE



BERNINA EMBROIDERY SOFTWARE 8 – MORE CREATIVITY IN 3D

BERNINA Embroidery Software 8 DesignerPlus is available on a USB stick and offers an advanced range of great features, including 3D effects, for unique surface embellishments.

Turn your favourite photo into an embroidered treasure with the Colour PhotoStitch feature. The 3D Globe Effect brings pattern fills to life while the incredible Couching Effect lets you blend wool thread and embroidery in a beautiful combination. Make your monograms and letters stand out with Puffy Lettering and achieve outstanding results with the advanced CutWork functions. Use the PunchWork and StumpWork options to add special effects to enhance your embroidery.

These incredible software features are easy to use and navigate with the updated user-friendly interface. The positioning feature makes it easy to place designs where you want them. Creating large designs is simple using the Multi-Hooping feature which automatically places more than one hoop when necessary. Palette positions are numbered for easy reference within the Colour Management system. Also embroidering on quilts just got easier with the Automated Quilt block layout feature.

There are no limits to your imagination with the BERNINA Embroidery Software 8 DesignerPlus. Apply special effects to artwork, add text, shapes and freehand drawing elements or trace bitmaps for unique multimedia projects. You can easily turn artwork from various graphic formats into embroidery designs in just one click using the Automatic Digitising tool. Preview your design as it would actually look on different items. Embroidery has never been easier and more fun.

DOWNLOAD THE FREE TRIAL VERSION OF
BERNINA EMBROIDERY SOFTWARE 8 FOR 30 DAYS
AT BERNINA.COM/V8
MICROSOFT® AND MAC® SUPPORTED INSTALLATION



Puffy Lettering adds outstanding 3D effects to your embroidered letters



Advanced CutWork with Eyelet Embroidery and Appliqué



COLOUR PHOTOSTITCH

Turn your best friend's photo into a realistic and detailed embroidery design. In just a few simple steps, the automatic digitising function transfers your photo into an easy-to-stitch embroidery design. Choose the colour and size, and the software does the rest.

3D GLOBE EFFECT

Create a 3D look with the Globe Effect feature where flat embroidery is turned in a 3D design through a visual illusion.

COUCHING

Create special embroidered effects with wool in combination with classic stitching. The wool threads pop out on your design for stunning effects.

DESIGN LIBRARY

The integrated Design Library offers quick access to all your designs, making it easy to browse, group, search or get inspired.

LEARN MORE ABOUT
BERNINA EMBROIDERY SOFTWARE 8
AT BERNINA.COM/SOFTWARE

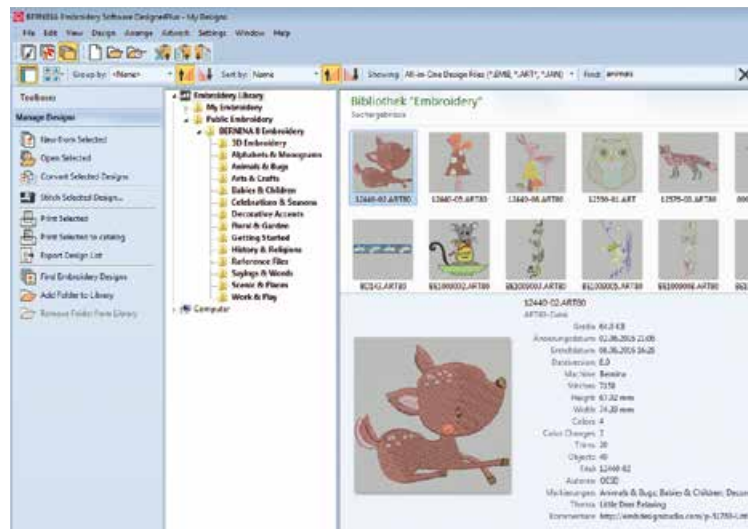
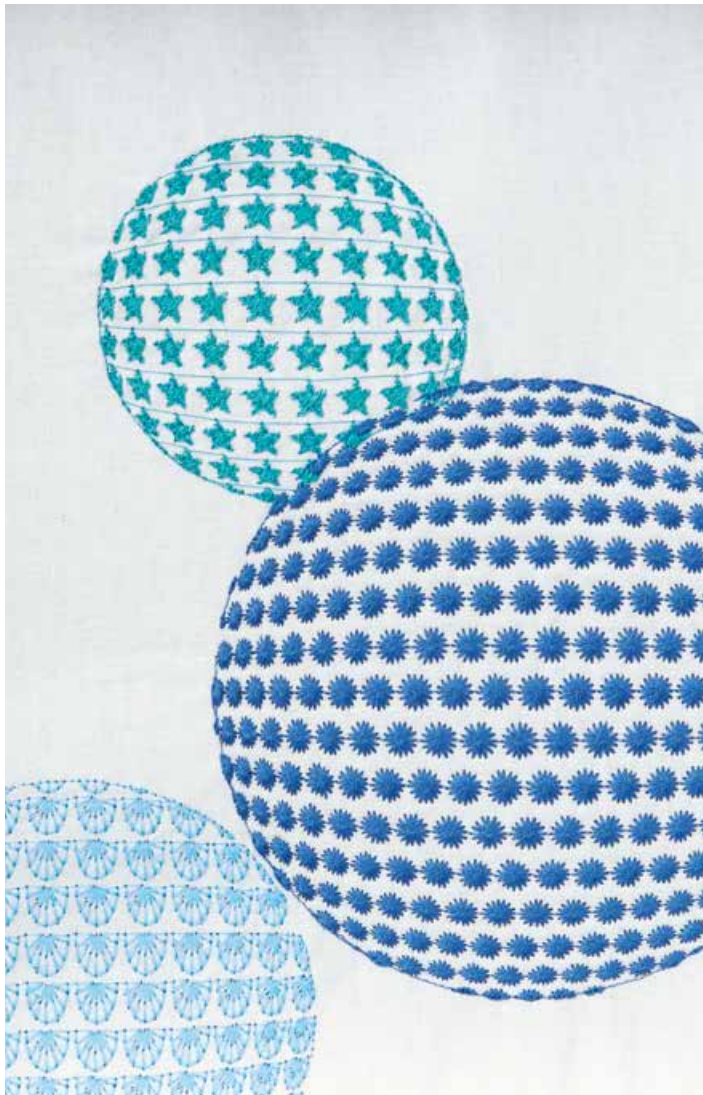

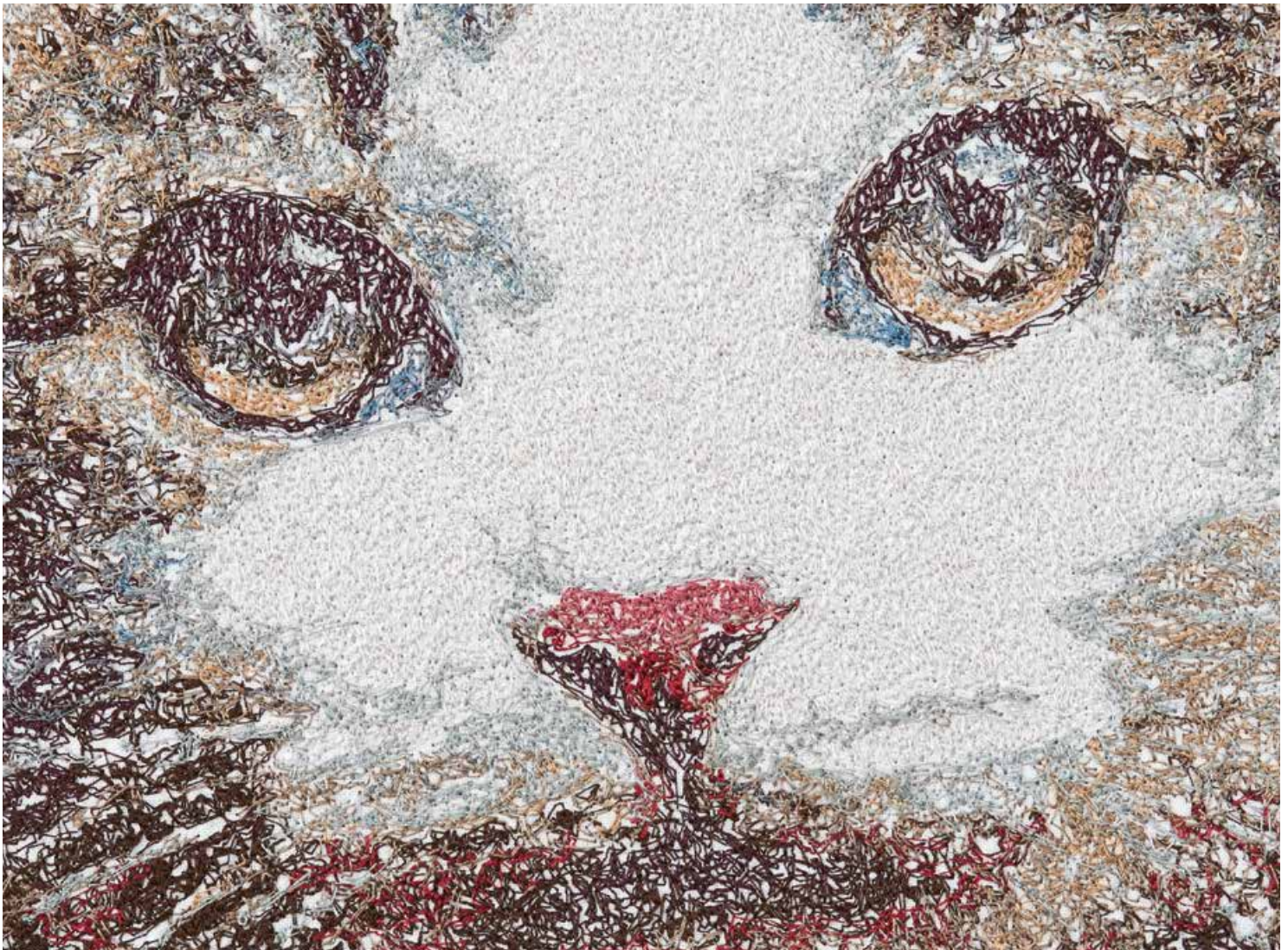

“Toolbox Software
is really the
bee’s knees
for embroidery.”



LIZZY HOUSE, TEXTILE ARTIST

**BERNINA TOOLBOX –
THE EASY-TO-USE SOFTWARE
FOR YOUNG CREATIVES**

- GET STARTED STRAIGHT AWAY – WITH A PC, MAC® OR TABLET
- COMPATIBLE WITH ALL COMMON EMBROIDERY MACHINES
- LARGE NUMBER OF EMBROIDERY MOTIFS INCLUDED
- FREE TRIAL VERSION

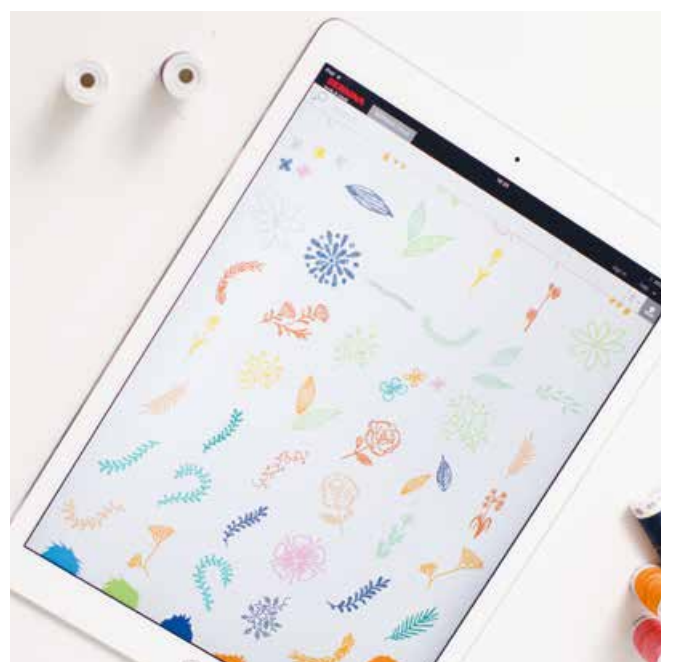



**“BERNINA Toolbox Software
- everything you need for
embroidery success.”**

Toolbox – the easy-to-learn and easy-to-use BERNINA embroidery software offering more flexibility than ever before. Toolbox is made up of separate, combinable modules that are also available as one complete package.

Choose a design to suit your personal taste from a wide variety of integrated embroidery designs available from the BERNINA Cloud. Editing embroidery designs is also possible in the Cloud, allowing you to implement your creative ideas wherever you are on your tablet.



COMPATIBLE WITH MICROSOFT® AND MAC®
FREE 30-DAY TRIAL VERSION:
BERNINA.COM/TOOLBOX-TRIAL

ADD AND EDIT LETTERING

The Lettering Basic module makes it possible to combine embroidery designs and fonts. Any number of designs can be combined quickly and easily with the 20 integrated fonts. The 6 text shapes make it possible to place text straight, vertically, in an arch, or in a circle. Rotate, enlarge, reduce individual letters, or even move them to a different position.

MODIFY AND DESIGN LETTERING

The Lettering module offers a large selection of 100 fonts, including 5 two-tone fonts, 6 text shapes, and text boxes used to embellish the lettering. Create insignias or other custom designs.

EDIT EMBROIDERY DESIGNS

The Editing module lets you combine multiple embroidery designs and edit individual elements, separately or combined, from one design. Whether you want to change colours or rearrange, combine, duplicate, group, mirror, skew, enlarge, or reduce – everything is possible.

PERSONALISATION

Personalise items such as clothing, hand towels, or napkins with a wide range of options. The Monogramming module offers 15 specially created Monogram fonts plus 10 additional fonts, making it possible to create the smallest monograms. All of these fonts can be combined as 1 to 3 letter monograms with over 60 monogram decorations.

ALL IN ONE!

Get all the functions the BERNINA Toolbox has to offer with the bundle. It includes all the functions and motifs from all the individual modules. Choose from among 600 designs from the BERNINA Cloud and edit them on your computer with the Toolbox software or work directly in the Cloud wherever and whenever you like. Now anything is possible.





CREATIVITY IN THREE DIMENSIONS

You can cut shapes, paint colourful designs, and create glittering crystal appliqués with a BERNINA sewing and embroidery machine. Use these techniques individually or in combination to explore new dimensions of creativity. Three unique accessories along with a modular software package turn your BERNINA embroidery machine into a creative multimedia machine.

The BERNINA DesignWorks Software Suite consists of three modules: CutWork, PaintWork and CrystalWork. Each module may be used independently, or in combination with the others. With the DesignWorks Software Suite and your PC, you can create unique designs to use with the PaintWork, CrystalWork and CutWork Tools.

With each of the DesignWorks modules, new designs can be created or existing embroidery files may be imported for editing. Use the CutWork module to create files for cutting custom shapes and appliqué designs. Use the PaintWork module to create designs to be drawn by your BERNINA embroidery machine. The CrystalWork module is used to create templates for glittering crystal appliqués. With the DesignWorks Software Suite and companion machine accessories, your BERNINA embroidery machine will bring your imagination to life.

Explore new possibilities and combine embroidery with CutWork, PaintWork, or CrystalWork. You'll be amazed at the stunning effects that can be achieved – whether on clothing, accessories, crafts, or quilts.



**BERNINA
DESIGNWORKS**





CUTWORK

The CutWork Software and Tool can cut up to 15 layers at one time, depending on the material, with precise, even edges. The shapes to be cut out are designed using the CutWork Software. In place of the needle, a special tool holding a small knife rotates in four locations to change the cutting direction. Create wonderful cutout effects and combine them with traditional embroidery applications. Shapes can easily be cut out and stitched on or appliquéd for three-dimensional effects. CutWork can be used to cut out single or multiple layers in any desired shape in a single operation to create perfect blocks for patchworking.

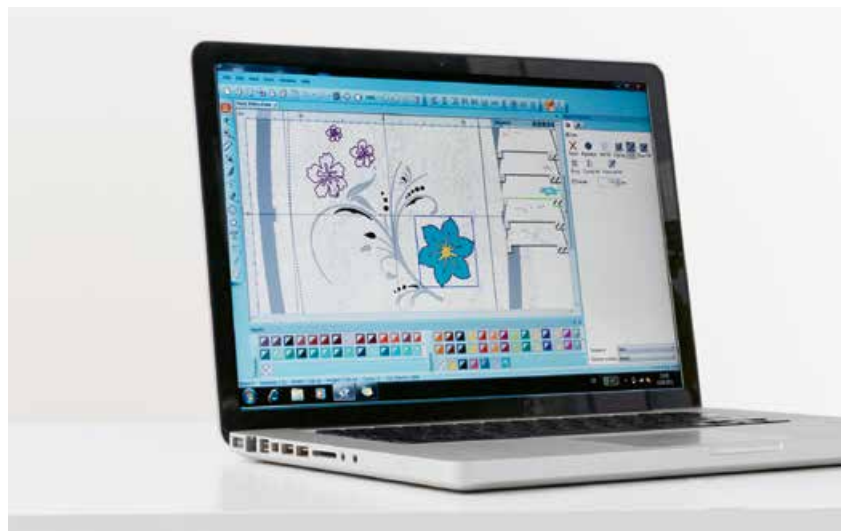

CRYSTALWORK

Embellish clothes or accessories with glittering crystal designs. First, create your own custom motif, pattern, or even lettering on the computer with the CrystalWork Software. Using the CrystalWork Tool in place of the needle, your DesignWorks-compatible embroidery machine will then create a custom template. Sprinkle crystals onto the template punch-holes and brush into place with a small brush. Using a heat-set appliqué, press firmly onto the template then gently lift, removing the crystals. Iron onto clothing, accessories, or any other crafting projects for instant flash. You can fill in a motif completely with crystals or simply apply them to the borders – either way, the results are sparkling!

PAINTWORK

As of now, creating your own fabric with perfectly coloured motifs and patterns is no longer just a dream. The PaintWork Software Module opens up even more possibilities for creating and editing your own designs or patterns on your PC before your DesignWorks-compatible embroidery machine begins its work. Replace the embroidery foot with the PaintWork Tool, which serves as a pen holder, and insert a fabric marker, pencil, or any drawing tool that fits into the holder. Your BERNINA paints the chosen motif onto the material in the embroidery hoop as if by magic. Embellish anything you like with painting or lettering and experiment with materials like leather, plastic, or paper – the possibilities are endless.



PROFESSIONAL QUILTING



DREAM BIG

Complete your big quilt projects with confidence, or explore the world of art-quilting. BERNINA Longarm quilting machines are the perfect partners for home or studio. For longarm quilting, the machine is mounted on a quilting frame or a special quilting table and is operated entirely from the front.

INTRODUCING BIG

The BERNINA Q20 and Q24 Longarm quilting machines are the result of the finest engineering expertise. They have been designed and engineered in Switzerland – and that is where they are assembled. Both machines are high-quality quilting machines which stand out owing to their ease of handling and robustness. Their exceptional design inspires quilters around the world.



YOU'LL FIND MORE INFORMATION AT
BERNINA.COM/LONGARM
NOT ALL PRODUCTS AND MODELS
ARE AVAILABLE IN ALL COUNTRIES



*“Having the Q24 in my studio
is a little slice of heaven.”*

LISA H. CALLE, LONGARM QUILT ARTIST

With a degree in Textile Management and Marketing, Lisa soon began to explore the “other” side of textiles ... the artistic side. She fell in love with quilting in 1997 and discovered longarm quilting in 2004. Her award-winning original designs have opened the door to teaching opportunities so that others can learn from her art and skills.

STATE-OF-THE-ART LONGARM QUILTING

QUILT BIG

Due to the simplicity of the machine and frame design this quilting system has the largest usable quilting space in its category. Select from a 20" or 24" platform to build the perfect system for home or studio.

The BERNINA Q20 comes standard as a sit-down model machine with a robust quilt table. The BERNINA Q24 is designed as a frame model machine and can only be used on the frame. The large freearm on both models offers a great deal of length and height, thus helping with big quilts.

Choose between:

- 20" sit-down model with quilt table
- 24" or 20" model with "Large" frame (13' / 4 m)
- 24" or 20" model with "Classic" frame (12' / 3,6 m)
- 24" or 20" model with "Small" frame (9' / 2,7 m)

Q-MATIC: QUILTING WITH SOFTWARE

Teaming up with the innovative BERNINA Q24 and Q20 machines on classic or large frames, Q-matic fulfills your automated quilting needs in just a few simple steps. Whether stitching out simple edge-to-edge designs or intricate custom patterns, your way to an original masterpiece will be extremely easy.

The intuitive Q-matic Software interface helps you finish your quilt with ease. The 21.5" all-in-one touch PC mounted to the side of the frame guarantees comfortable access to all designing and quilting features. For ease-of-use, additional sewhead interaction screens allow control of design stitch-out and placement directly with the sewhead. Returning to the main screen is not necessary, making your quilting highly efficient.

The Q-matic Kit is only available in selected markets.



FEATURES

General

	Hook system*	Colour touch screen	Space to the right of the needle, in mm	Sewing light	Weight of the machine, in kg	Needle positions	Sewing in each needle position	Maximum stitch width in mm	Maximum stitch length in mm	Multi-function knobs	Changing stitch settings while sewing	Start/stop button (stitching without foot control)	Speed control	Programmable BERNINA foot control	BERNINA Foot Control (with back-kick function on some models)	Built-in needle threader	Automatic needle threader	Automatic presser foot pressure	Presser foot hover feature	Upper-thread indicator	Lower-thread indicator	Automatic thread indicator	Manual thread cutter	Needle stop up/down	Drag & Drop	Bobbin winding while sewing/embroidering	BERNINA Dual Feed	BERNINA Adaptive Thread Tension	BSR-enabled	On-screen help
B 880 PLUS	RL	x ¹	300	LED	16	11	x	9	6	x	x	x	x	x	-	x	x	x	x	x	x	x	x	x	x	x	x	x	x	x
B 790 PLUS	B	x ¹	254	LED	14	11	x	9	6	x	x	x	x	x	-	x	x	x	x	x	x	x	x	x	x	x	x	x	x	x
B 770 QE	B	x ²	254	LED	14	11	x	9	6	x	x	x	x	x	-	x	x	x	x	x	x	x	x	x	x	x	x	x	x	x
B 740	B	x ²	254	LED	14	11	x	9	6	x	x	x	x	-	x	x	-	x	x	x	x	x	x	-	x	x	x	x	x	x
B 720	B	x ²	254	LED	14	11	x	5.5	6	x	x	x	x	-	x	x	-	x	x	x	x	x	x	x	x	-	x	x	x	x
B 700	B	x ¹	254	LED	14	-	-	-	-	x	-	x	x	-	Opt.	x	-	-	x	-	x	x	x	-	x	x	-	x	-	x
B 590	B	x ²	215	LED	11	11	x	9	6	x	x	x	x	x	x	-	x	x	x	x	x	x	x	x	x	x	x	x	x	x
B 570 QE	B	x ²	215	LED	11	11	x	9	6	x	x	x	x	x	x	-	x	x	x	x	x	x	x	x	x	x	x	x	x	x
B 540	B	x ²	215	LED	11	11	x	9	6	x	x	x	x	-	x	x	-	-	-	-	x	-	x	x	x	-	x	x	x	x
B 535	B	x ²	215	LED	11	11	x	5.5	6	x	x	x	x	-	x	x	-	-	-	-	x	-	x	x	x	-	x	x	x	x
B 500	B	x ²	215	LED	11	-	-	-	-	x	-	x	x	-	Opt.	x	-	-	x	-	x	x	x	-	x	x	-	x	-	x
B 485	B	x ²	177.7	LED	9.5	11	x	5.5	6	x	x	x	x	x	x	-	-	-	-	-	-	x	x	x	-	x	-	x	x	x
B 480	B	x ²	177.7	LED	9.5	11	x	9	6	x	x	x	x	x	x	-	-	-	-	-	-	x	x	x	-	x	-	x	x	x
B 475 QE	B	x ²	177.7	LED	9.5	11	x	5.5	6	x	x	x	x	-	x	x	-	-	-	-	-	-	x	x	x	-	x	-	x	x
B 435	B	x ²	177.7	LED	9.5	11	x	5.5	6	x	x	x	x	-	x	x	-	-	-	-	-	-	x	x	-	x	-	x	-	x
B 335	CB	-	160	LED	8	9	x	5.5	5	-	x	x	x	-	x	x	-	-	-	-	-	-	x	x	-	x	-	-	-	-
B 325	CB	-	160	LED	8	9	x	5.5	5	-	x	x	x	-	x	x	-	-	-	-	-	-	x	x	-	x	-	-	-	-
B 1008	CB	-	180	x	9	5	x	5.5	5	-	-	-	-	-	x	-	-	-	-	-	-	-	-	-	-	-	-	-	-	-

* RL = Rotary hook
 B = BERNINA hook
 CB = CB hook (central bobbin)

¹ 7-inch (17cm) TFT screen
² 4.3-inch (10cm) TFT screen

Not all models are available in all countries.

Sewing and Quilting

	Sewing tutorial	Embroidery tutorial	Creative Consultant	Embroidery Consultant	Personal memory	Memory	History function (most recently used stitch patterns)	USB interface for PC connection	USB interface for USB data stick	Setup program	Language selection	Alarm clock	Eco mode	Maximum sewing speed	Mirror Image	Directional sewing 360°	Distortion	Sideways motion	Pattern start/end function	Connecting stitches	Pattern elongation	Safety function	Programmable securing function	Stitch Designer	Triple Stitch Function	Total number of sewing stitch patterns (incl. alphabet)	Utility stitches	Buttonhole types	Automatic buttonhole (incl. eyelet types)	Manual multistep buttonhole	Button sew-on program	Darning programs	Decorative stitches	Decorative sideways	Quilt:
	x	x	x	x	x	x	x	x	x	x	x	x	x	1200	x	x	x	x	x	x	x	x	x	x	-	1764	38	19	x	x	x	3	630	109	66
	x	x	x	x	x	x	x	x	x	x	-	x	1000	x	x	-	x	x	x	x	x	x	x	-	1352	32	15	x	x	x	2	506	117	34	
	x	x	x	-	x	x	-	x	x	x	-	x	1000	x	-	-	-	x	-	x	x	-	-	-	992	30	13	x	x	x	2	283	-	50	
	x	-	x	-	x	x	-	x	x	x	-	x	1000	x	-	-	-	x	-	x	x	-	-	-	800	29	11	x	x	x	2	200	-	23	
	x	x	x	-	x	x	-	x	x	x	-	x	1000	x	-	-	-	x	-	x	x	-	-	-	681	29	11	x	x	x	2	200	-	32	
	-	x	-	x	-	x	-	x	x	x	-	x	No sewing function																						
	x	x	x	x	x	x	-	x	x	x	-	x	1000	x	-	-	-	x	-	x	x	-	-	x	1774	38	18	x	x	x	2	500	-	59	
	x	x	x	-	x	x	-	x	x	x	-	x	1000	x	-	-	-	x	-	x	x	-	-	x	1450	34	16	x	x	x	2	450	-	73	
	x	x	x	-	x	x	-	x	x	x	-	x	1000	x	-	-	-	x	-	-	x	x	-	-	1048	30	14	x	x	x	2	300	-	44	
	x	x	x	-	x	x	-	x	x	x	-	x	1000	x	-	-	-	x	-	-	x	x	-	-	1048	30	14	x	x	x	2	300	-	44	
	-	x	-	x	-	x	-	x	x	x	-	x	No sewing function																						
	x	-	x	-	x	x	-	x	x	x	-	x	900	x	-	-	-	x	-	x	x	x	-	-	994	29	11	x	x	x	2	250	-	27	
	x	-	x	-	x	x	-	x	x	x	-	x	900	x	-	-	-	x	-	x	x	x	-	-	994	29	11	x	x	x	2	250	-	27	
	x	-	x	-	x	x	-	x	x	x	-	x	900	x	-	-	-	x	-	-	x	x	-	-	840	29	10	x ^a	x	x	2	200	-	40	
	x	-	x	-	x	x	-	x	x	x	-	x	900	x	-	-	-	x	-	-	x	-	-	-	650	29	9	x ^a	x	x	2	150	-	13	
	-	-	-	-	-	x	-	-	-	-	-	-	900	x	-	-	-	x/-	-	-	-	-	-	-	221	20	5	x	x	x	1	91	-	12	
	-	-	-	-	-	x	-	-	-	-	-	-	900	-	-	-	-	x/-	-	-	-	-	-	-	97	15	1	x ^a	x	x	1	23	-	3	
	-	-	-	-	-	-	-	-	-	-	-	-	900	-	-	-	-	-	-	-	-	-	-	-	17	14	1	-	x	-	1	2	-	-	

										Embroidery ⁴																						
Decorative stitching	Cross-stitch programs	Tassel/tapering/skyline stitch patterns	Sewing alphabets ³	Monograms	Maximum embroidery speed (with sideways motion only)	Large embroidery module L (maximum embroidery area 400 x 260 mm)	Medium embroidery module M (maximum embroidery area 400 x 150 mm)	Built-in embroidery designs	Embroidery alphabets	Embroidery design format	Midi Hoop functionality	Mega Hoop functionality	Maxi Hoop functionality	Jumbo Hoop functionality	Freearm embroidery	On-screen design editing – mirror, rotate, skew	Combining patterns	Personal memory for saving embroidery designs	Standard embroidery frames ⁷	Word ART	Shape Designer	Embroidering sewing stitches	Colour resequencing	Colour Wheel	Pinpoint Placement	Group/Ungroup	Undo/Redo	Invisible Secure	Smart Secure	Thread-Up Command	Thread Away Mode	
31	81	11	x	1000	x	–	462	21	x	x	x	x	x	x	x	x	x	³ _(o,m,s)	x	x	x	x	x	x	x	x	x	x	x	x	B 880 PLUS	
37	52	8	x	1000	x ⁵	–	332	18	x	x	x	x ⁶	x	x	x	x	x	³ _(o,m,s)	x	–	x	x	x	x	x	x	x	x	x	x	B 790 PLUS	
20	–	6	–	1000	Opt. ⁵	–	140	6	x	x	x	x ⁶	x	x	x	x	x	³ _(o,m,s)	–	–	–	–	–	–	–	–	x	x	x	x	B 770 QE	
21	–	5	–	No embroidery function				No embroidery function																			B 740					
14	–	4	–	1000	Opt. ⁵	–	80	4	x	x	x	x ⁶	x	x	x	x	x	³ _(o,m,s)	–	–	–	–	–	–	–	–	x	x	x	x	B 720	
				1000	x ⁵	–	320	18	x	x	x	x ⁶	x	x	x	x	x	³ _(o,m,s)	x	–	–	x	–	x	x	x	x	x	x	x	B 700	
40	–	9	–	1000	–	x	275	8	x	x	–	–	x	x	x	x	² _(o,m)	x	–	x	x	x	x	x	x	x	x	x	x	x	B 590	
34	–	8	–	1000	–	Opt.	250	7	x	x	–	–	x	x	x	x	² _(o,m)	x	–	–	x	–	–	–	–	–	x	x	x	x	B 570 QE	
31	–	5	–	1000	–	Opt.	50	4	x	x	–	–	x	x	x	x	² _(o,m)	x	–	–	x	–	–	–	–	–	x	x	x	–	B 540	
31	–	5	–	1000	–	Opt.	50	4	x	x	–	–	x	x	x	x	² _(o,m)	x	–	–	x	–	–	–	–	–	x	x	x	–	B 535	
				1000	–	x	275	8	x	x	–	–	x	x	x	x	² _(o,m)	x	–	–	x	x	x	x	x	x	x	x	x	x	B 500	
21	–	5	–	No embroidery function																			B 485									
21	–	5	–	No embroidery function																			B 480									
13	–	4	–	No embroidery function																			B 475 QE									
11	–	3	–	No embroidery function																			B 435									
4	–	2	–	No embroidery function																			B 335									
3	–	1	–	No embroidery function																			B 325									
–	–	–	–	No embroidery function																			B 1008									

³ The Cyrillic and Japanese alphabets are included on some models.

⁴ Models with an embroidery function need an additional embroidery module for embroidery purposes, which is not included in the standard delivery in all countries.

⁵ Limited embroidery area 400 x 210 mm (15.7" x 8.3")

⁶ Limited embroidery field 400 x 210 mm (15.7" x 8.3")

⁷ Large oval = 255 x 145 mm (10.0" x 5.7"), medium = 130 x 100 mm (5.1" x 3.9"), small = 72 x 50 mm (2.8" x 2")

⁸ The Buttonhole foot with slide #3A is needed for the automatic buttonhole. With the B 435 and B 475 QE with presser foot soles (soles version) and the B 325, this foot is not included in the standard delivery.

Standard Accessories Sewing													Precision Presser Feet Provided as Standard																
Automatic jump stitch cutting	Programmable jump stitch cutting	Stitch sequence control	Basting	Endless embroidery	Position recall	Compatible with BERNINA DesignWorks Software Suite and Tools	BERNINA Free Hand System (FHS)	Knee lever for FHS	BERNINA frearm slide-on table	Accessories box/bag	Dust cover	Triple or multiple spool holder	BERNINA Precision Presser feet/soles included	Reverse-pattern foot #1/1C	Dual Feed reverse-pattern foot #1D	Overlock foot #2/2A	Buttonhole foot with slide #3A	Zipper foot #3/3C	Blindstitch foot #5	Jean's foot #8/8D	Button sew-on foot #18	Open embroidery foot #20/20C/20D	Embroidery foot #26 ⁹	Patchwork foot #37/37D (1/4x1/6mm)	BERNINA Stitch Regulator #40C	Walking foot #50	Patchwork foot #97/97D (1/4x1/6 mm)		
x	x	x	x	x	x	x	x	x	x	x	x	12	x	x	x	x	x	x	-	x	x	x	-	x	x	-	-	B 880 PLUS	
x	x	x	x	x	x	x	x	x	x	x	Opt.	11	x	x	x	x	-	x	x	-	x	x	-	x	x	-	-	B 790 PLUS	
x	x	x	x	-	x	x	x	x	x	x	Opt.	7	x	x	-	x	-	x	-	-	x	-	-	-	x	-	x	B 770 QE	
							x	x	x	x	Opt.	5	x	x	-	x	-	x	-	-	x	-	-	-	-	-	-	B 740	
x	x	x	x	-	x	x	x	x	x	x	Opt.	5	x	-	-	x	-	x	-	x	-	-	-	-	-	-	-	B 720	
x	x	x	x	x	x	x	Opt.	-	x	x	x	1	-	-	-	-	-	-	-	-	-	x	-	-	-	-	-	B 700	
x	x	x	x	x	x	x	x	x	x	x	Opt.	9	x	x	x	x	-	x	x	-	-	x	x	-	-	x	-	B 590	
x	x	x	x	-	x	x	x	x	x	x	Opt.	8	x	x	x	x	-	x	-	-	-	x	-	-	-	x	-	x	B 570 QE
x	x	x	x	-	x	x	x	x	x	x	Opt.	5	x	-	x	x	-	x	-	-	-	x	-	-	-	-	-	B 540	
x	x	x	x	-	x	x	x	x	x	x	Opt.	5	x	-	x	x	-	x	-	-	-	x	-	-	-	-	-	B 535	
x	x	x	x	x	x	x	Opt.	-	x	x	Opt.	1	-	-	-	-	-	-	-	-	-	x	-	-	-	-	-	B 500	
							x	x	x	x	-	5	x	-	x	x	-	x	x	-	-	-	-	-	-	-	-	B 485	
							x	x	x	x	-	5	x	-	x	x	-	x	x	-	-	-	-	-	-	-	-	B 480	
							x	x	x	x	-	6 ¹⁰	x	-	x	-	x	x	x	-	-	(x) ¹⁰	-	x	-	-	-	B 475 QE	
							x	Opt.	x	x	x	-	5 ¹⁰	x	-	x	-	x	x	x	-	-	(x) ¹⁰	-	-	-	-	B 435	
							x	Opt.	x	x	x	-	6	x	-	x	x	-	x	x	-	-	x	-	-	-	-	B 335	
							-	-	x	x	-	5	x	-	x	-	x	x	x	-	-	-	-	-	-	-	-	B 325	
							-	-	Opt.	x	x	-	5	x	-	x	-	x	x	x	-	-	-	-	-	-	-	B 1008	

⁹ Embroidery foot #26 is supplied as standard when purchasing an embroidery module, and not with the machine.

¹⁰ Depending on the country, presser feet or presser foot soles are part of the standard range. The presser foot soles version includes one more.

Not all models and accessories are available in all countries.

Depending on the model and country, the embroidery module is either available on option or provided with the machine.

We reserve the right to make changes to machine features, equipment, and design.

Additional information is available at your local BERNINA store.

LOOKING FOR A NEW SEWING PROJECT?

You can find what you want in "inspiration", our customer magazine. Thanks to great sewing patterns and detailed sewing instructions, every project succeeds right away.

INSPIRATION MAGAZINE IS AVAILABLE IN GERMAN, ENGLISH, FRENCH AND DUTCH



WITH AN ANNUAL SUBSCRIPTION* YOU GET THE MAGAZINE SENT DIRECTLY TO YOUR DOOR FOUR TIMES A YEAR. WWW.BERNINA.COM

BERNINA

* Not available in all countries.