

# Bernette® *Deco* 600



**Instruction Manual**  
**Manual de instrucciones**

Dear Customer

Congratulations on the purchase of your Bernette Deco 600 embroidery machine. You are now the proud owner of an embroidery machine which fulfills every expectation in terms of use and quality. The unique design selection makes sewing more fun than ever and will give you years of sewing pleasure.

Our comprehensive instruction manual takes you step by step through the features and handling of your new machine. We also provide you with tips and suggestions for practical sewing.

If you require any further information about your machine or sewing in general, please do not hesitate to contact your Bernina dealer who will be delighted to help you.

We wish you happy and successful sewing.

FRITZ GEGAUF LTD.  
CH-8266 Steckborn, Switzerland

Your machine is an advanced computerized home embroidery machine. To fully enjoy all of its features, we suggest that you study this instruction manual.

## PLEASE READ BEFORE USING YOUR EMBROIDER MACHINE

### For safe operation

1. Be sure to keep your eye on the needle while sewing. Do not touch the balance wheel, thread take-up, needle, or other moving parts.
2. Remember to turn off the power switch and unplug the cord when:
  - Operation is complete
  - Replacing or removing the needle or any other parts
  - A power failure occurs during use
  - Maintaining the machine
  - Leaving the machine unattended.
3. Plug the machine directly into the wall. Do not use extension cords.
4. Always be sure to turn off the main power switch when inserting and removing the embroidery card. Do not touch the embroidery card inserted in the card slot while your machine turns on.

### For a longer service life

1. When storing your embroidery machine, avoid direct sunlight and high humidity locations. Do not store the embroidery machine beside a space heater, iron, or other hot objects.
2. Use only neutral soaps or detergents to clean the case. Benzene, thinner, and scouring powders can damage the case and machine, and should never be used.
3. Do not drop or hit the machine.
4. Always consult the operation manual or use the "BASIC OPERATION" key when replacing or installing any assemblies; needle, or other parts to assure correct installation.

### For repair or adjustment

In the event a malfunction occurs or adjustment is required, first follow the troubleshooting table in the back of the operation manual to inspect and adjust the machine yourself. If the problem persists, please consult your nearest authorized service center.

- We reserve the right to make changes in the interests of technical progress.

# CONTENTS

## CHAPTER 1

<b>MACHINE KNOWLEDGE</b> .....	<b>3</b>
PRINCIPAL PARTS AND THEIR DESCRIPTION .....	3
MAIN POWER SWITCH AND CONNECTORS .....	4
SELECTION KEYS .....	5
"START/STOP" BUTTON .....	5
ACCESSORIES .....	6
OPTIONS .....	7
OPERATION (SELECTION KEYS) .....	8
HOW TO USE THE LANGUAGE SELECTION KEY .....	11
How to clear the language selection .....	12
BOBBIN WINDING AND INSTALLATION .....	13
Setting the bobbin .....	15
UPPER THREADING .....	16
Auto needle threading device .....	17
PREPARATION BEFORE EMBROIDERING .....	18
Attaching stabilizer material .....	18
Embroidering different types of fabric .....	18
Setting the fabric in the embroidery frame .....	20
Fitting the embroidery frame to the machine .....	22
Removing the embroidery frame .....	22
THREAD TENSION ADJUSTMENT .....	23
ADJUSTING THE LCD SCREEN CONTRAST .....	24
If the LCD is hard to see when the power is turned on .....	24
CHANGING THE NEEDLE .....	25

## CHAPTER 2

<b>EMBROIDERING</b> .....	<b>26</b>
EMBROIDERY .....	26
Start embroidering .....	28
Programmed automatic thread cutting .....	28
Using the "THREAD CUTTER" key ..	29
Embroidering advice .....	29
HOW TO SELECT PATTERNS .....	30
Selecting built-in embroidery patterns .....	30
Selecting alphabetic characters .....	31
Uppercase & lowercase .....	32
Changing the character size to one of three different sizes .....	33
Correcting characters .....	33
Checking the characters input .....	34
Changing the color of single characters .....	34
Selecting frame patterns .....	35
Selecting one-point patterns .....	37
Displaying the embroidery time for one-point patterns .....	39

Displaying the color names for one-point patterns .....	39
Selecting patterns from a memory card .....	40
MEMORY .....	41
Saving a pattern combination in memory .....	41
Retrieving a pattern which has been saved .....	42
CHANGING THE SETTINGS FOR THE SELECTED PATTERN .....	43
Moving the position (LAYOUT) .....	43
Changing the embroidery position .....	44
Checking the embroidery area .....	44
Embroidering from a specific starting point .....	45
Changing the pattern direction .....	45
Mirror imaging patterns .....	46
Changing the size of characters and frame patterns .....	47
Changing thread density of the stitch on characters and some frame patterns ..	47
SEWING A BASIC EMBROIDERY PATTERN .....	48
Embroidering multi-color patterns .....	48
Embroidering single color patterns ..	48
Embroidering a single color pattern when "MULTI COLOR" is displayed ..	49
Embroidering characters that extend beyond one frame .....	50
EMBROIDERY APPLICATIONS .....	51
Combining a frame pattern with a design .....	51
Embroidering appliques (using a frame pattern) .....	52
Embroidering onto small pieces of fabric or onto corners .....	53
IF THREAD BREAKS DURING EMBROIDERING OR WHEN PARTLY COMPLETING A PATTERN .....	54
If thread breaks during embroidering .....	55
Re-embroidering from the beginning .....	56

<b>MAINTENANCE</b> .....	<b>57</b>
CHANGING THE LIGHT BULB .....	57
CLEANING .....	58
<b>ERROR MESSAGE</b> .....	<b>59</b>
<b>TROUBLESHOOTING</b> .....	<b>62</b>
<b>PATTERNS</b> .....	<b>65</b>
<b>EMBROIDERING USING A SMALL FRAME (OPTIONAL)</b> .....	<b>67</b>
<b>EMBROIDERING USING A EXTRA-SMALL FRAME (OPTIONAL)</b> .....	<b>68</b>
<b>EMBROIDERING USING A LARGE FRAME (OPTIONAL)</b> .....	<b>69</b>
Linking two or more embroidered patterns (using the 90° rotation feature) .....	70

## PRINCIPAL PARTS AND THEIR DESCRIPTION

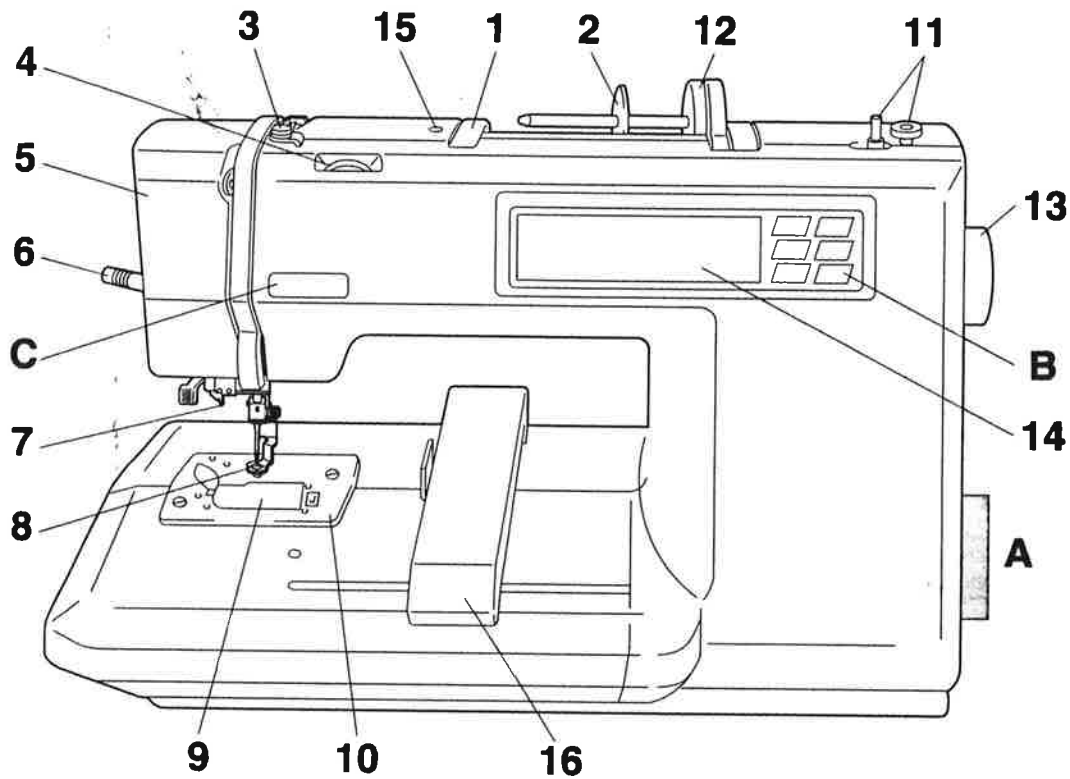

- 1-Handle
- 2-Spool cap
- 3-Bobbin winding guide
- 4-Upper thread tension dial
- 5-Face plate
- 6-Presser foot lever
- 7-Needle threader
- 8-Presser foot
- 9-Bobbin cover
- 10-Needle plate
- 11-Bobbin winding device
- 12-Spool felt
- 13-Balance wheel
- 14-LCD (Liquid Crystal Display)
- 15-Hole for extra spool pin
- 16-Carriage (Embroidery arm)

- A-MAIN POWER SWITCH AND CONNECTORS
- B-SELECTION KEYS
- C-"START/STOP" BUTTON

## MAIN POWER SWITCH AND CONNECTORS

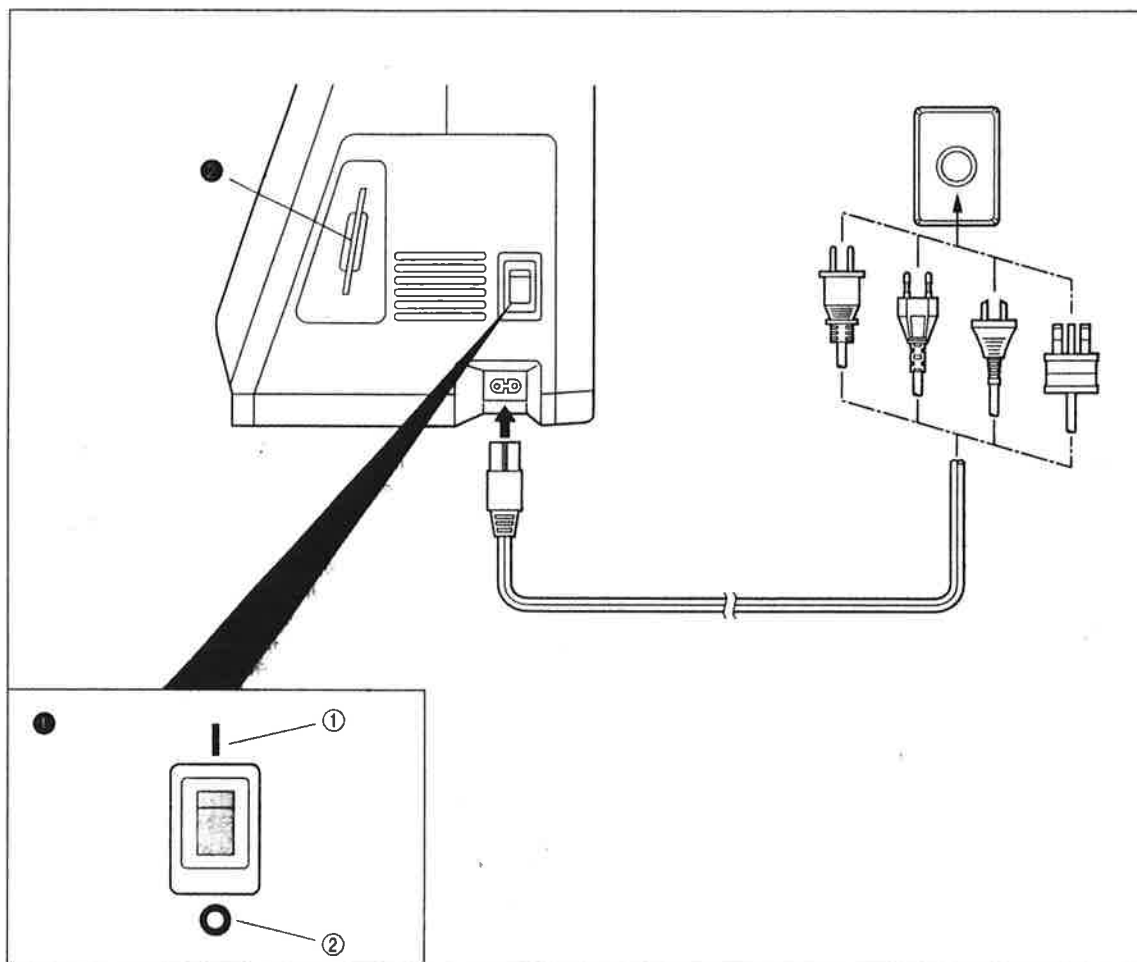

- Power switch
  - ① ON
  - ② OFF
- Memory card slot

### CAUTION

- When leaving the sewing machine unattended, the main switch of the machine must be switched off and the plug removed from the socket-outlet.
- When servicing the sewing machine, or when removing covers or changing lamps, the machine must have the plug removed from the socket-outlet.
- For U.S.A. only  
This appliance has a polarized plug (one blade wider than the other). To reduce the risk of electric shock, this plug is intended to fit in a polarized outlet only one way. If the plug does not fit fully in the outlet, reverse the plug. If it still does not fit, contact a qualified electrician to install the proper outlet. Do not modify the plug in any way.

## SELECTION KEYS

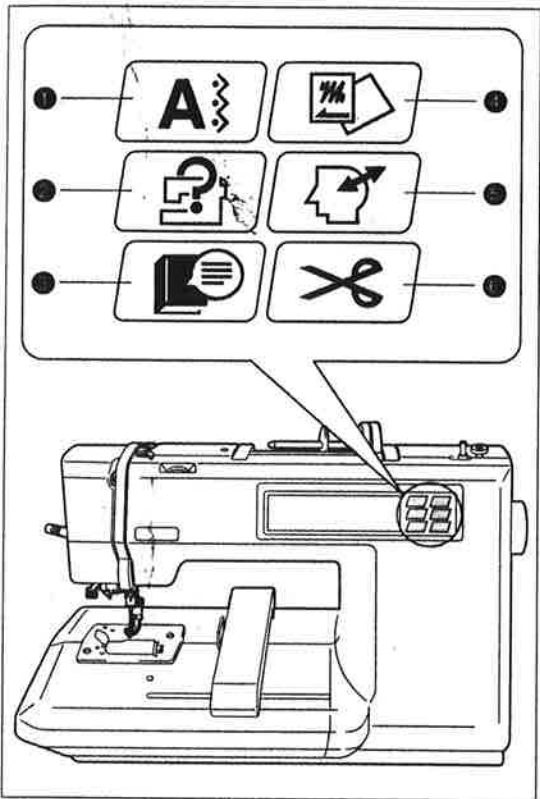

- ❶ "CHARACTERS & DESIGNS" KEY  
Use this key for embroidering characters and patterns.
- ❷ "BASIC OPERATION" KEY  
Use this key for more information on how to use this embroidery machine.
- ❸ "MODIFY & ADVISE" KEY  
Use this key when you have problems with embroidering. This is a useful key to remember.
- ❹ "CARD" KEY  
Use this key to select a memory card for embroidery patterns.
- ❺ "MEMORY" KEY  
Use this key for saving or retrieving pattern combinations in the machine.
- ❻ "THREAD CUTTER" KEY  
Use this key when you would like to cut the thread automatically while embroidering.

## "START/STOP" BUTTON

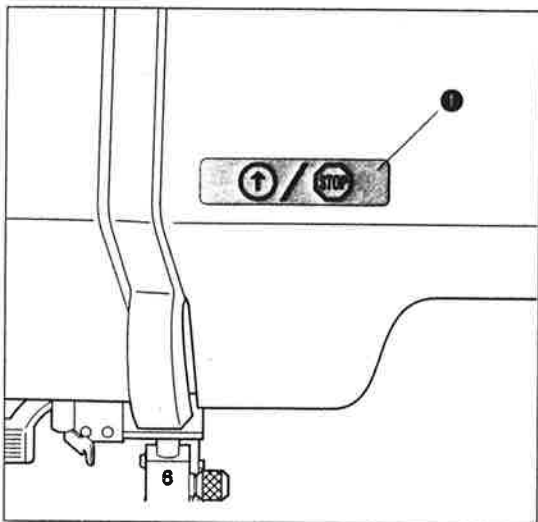

Press this button to start the machine, and then press it once more to stop the machine.

- \* The machine will operate at low speed while the button is being pressed and then speed up when the button is released.
- \* When the machine stops, the needle will stop at its highest position.
- \* If "Raise the needle." appears on the display, press the "START/STOP" button to stop the needle at its highest position.

- ❶ "START/STOP" BUTTON

# ACCESSORIES

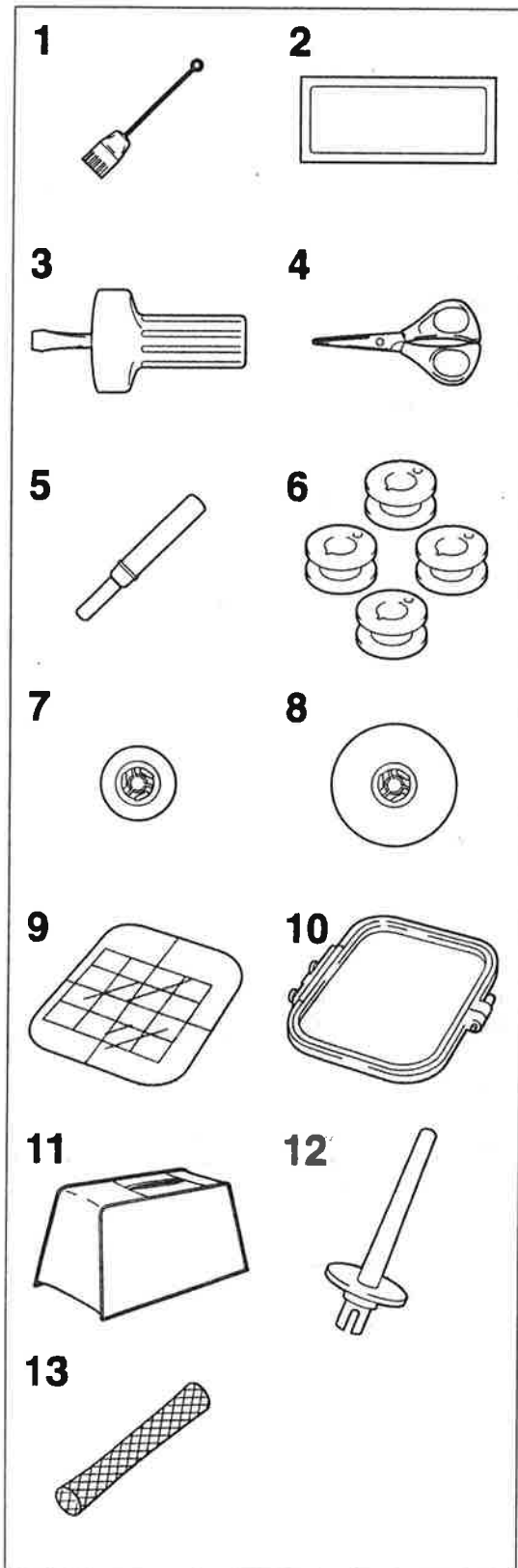

No.	Parts Name	Parts Code
1	Cleaning brush	122992-001
2	Needle set 75/11 3pcs., 90/14 1 pc.	X59535-001
3	Screwdriver	X53666-001
4	Scissors	184783-001
5	Seam ripper	X54243-001
6	Bobbins (4 pcs)	136492-101
7	Spool cap (Small)	130013-003
8	Spool cap (Large)	130012-003
9	Embroidery sheet (Regular)	XA3728-001
10	Embroidery frame (Regular)	X58739-003
11	Machine cover*	XA0181-052
12	Extra spool pin**	130920-051
13	Net***	127610-000

\* When placing the machine cover on the machine while the embroidery frame is still attached, touch "CHARACTERS & DESIGNS" or "CARD" to return the embroidery arm to its storage position. An alternate method to return the embroidery arm to its storage position would be to turn the machine off and then turn it on again, allow the arm to re-set itself and then turn off the machine.

\*\* An extra spool pin should be used for decorative thread such as metallic thread.

\*\*\* If using special threads which wind quickly off the thread spool, attach a net to the spool before using.

# OPTIONS

1

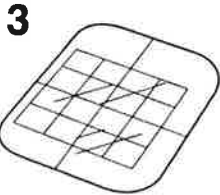

4



7

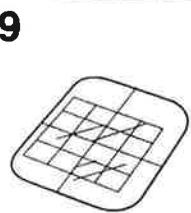

10

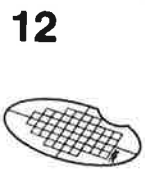

14



15



No.	Parts Name	Parts Code
1	Embroidery set (Regular)	XA3727-001
2	Embroidery frame (Regular)	X58739-003
3	Embroidery sheet (Regular)	XA3728-001
4	Embroidery set (Large)	XA3733-001
5	Embroidery frame (Large)	X59028-003
6	Embroidery sheet (Large)	XA3734-001
7	Embroidery set (Small)	XA3730-001
8	Embroidery frame (Small)	X59005-003
9	Embroidery sheet (Small)	XA3731-001
10	Embroidery set (Extra-small)	XA3713-001
11	Embroidery frame (Extra-small)	XA3714-001
12	Embroidery sheet (Extra-small) (Vertical type)	XA3718-001
13	Embroidery sheet (Extra-small) (Horizontal type)	XA3802-001
14	Backing material (Stabilizer material)	X80940-001
15	Memory card: Various themes	



# OPERATION (SELECTION KEYS)

Most of the instructions are in the machine's memory. Messages on the LCD screen guide you through each operation.

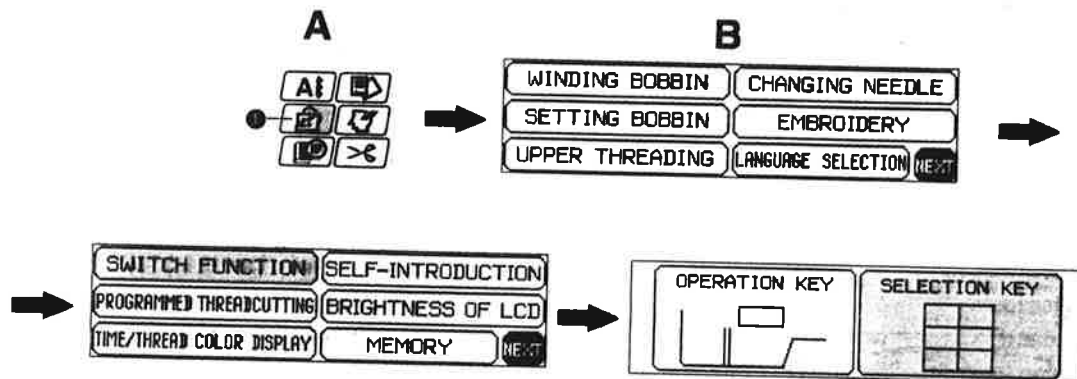

## ① "BASIC OPERATION" key

1. Press "BASIC OPERATION".
2. Touch "NEXT".
3. Touch "SWITCH FUNCTION".
4. Touch "SELECTION KEY".

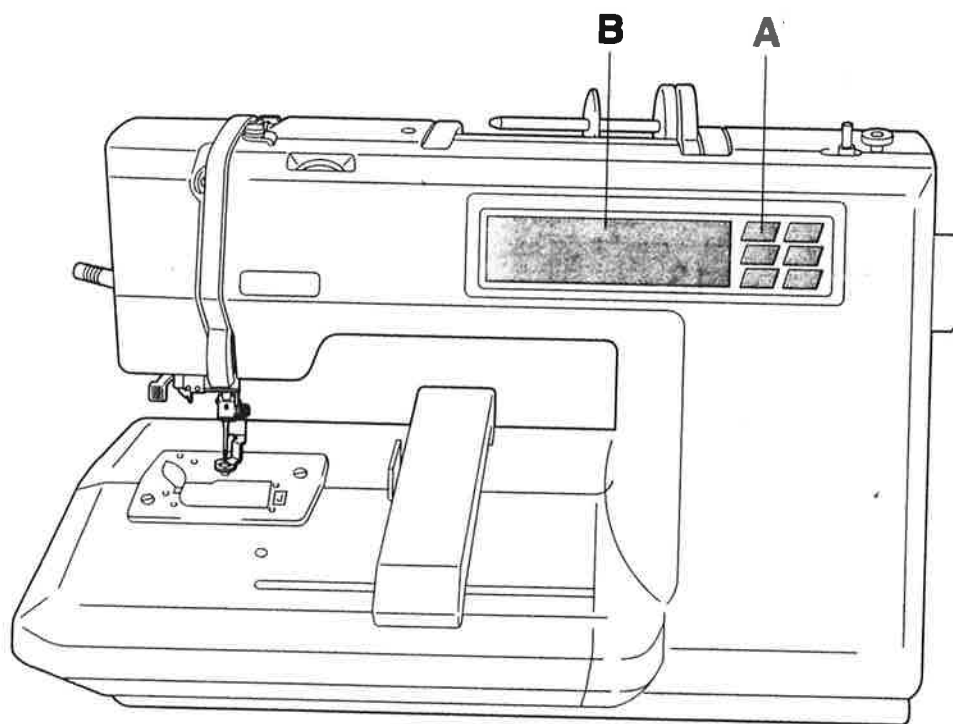

## Using the selection keys

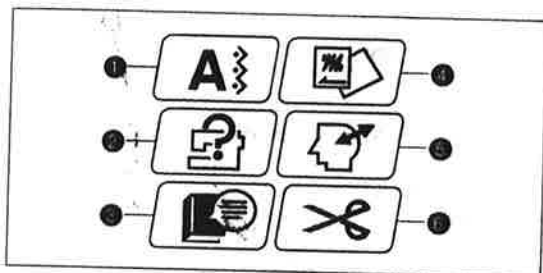

### A. Selection keys

Select one of the six keys that explain the functions of the machine, and press that key. When you press the key, the LCD at the left will change to display the information that you requested.

- ① "CHARACTERS & DESIGNS" KEY
- ② "BASIC OPERATION" KEY
- ③ "MODIFY & ADVISE" KEY
- ④ "CARD" KEY
- ⑤ "MEMORY" KEY
- ⑥ "THREAD CUTTER" KEY

## Operation using the screen

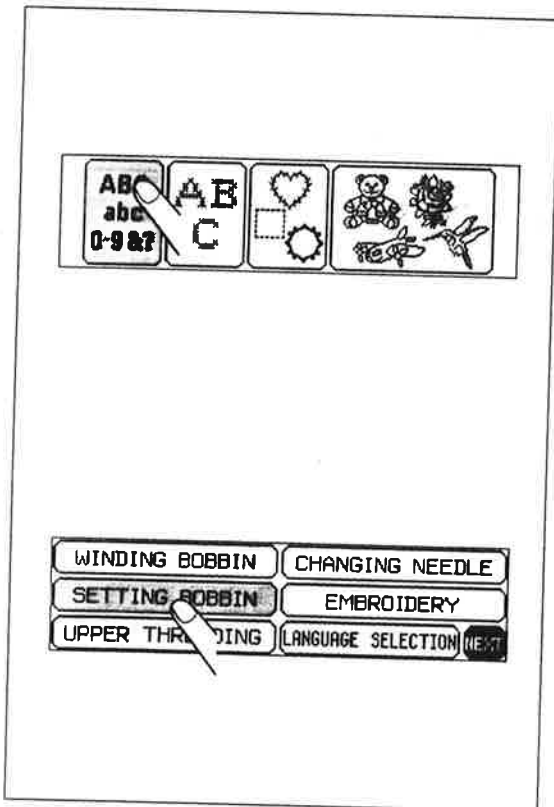

### B. LCD screen

A pattern or operation can be selected by gently touching the box on the screen which corresponds to the pattern or operation that you wish to select.

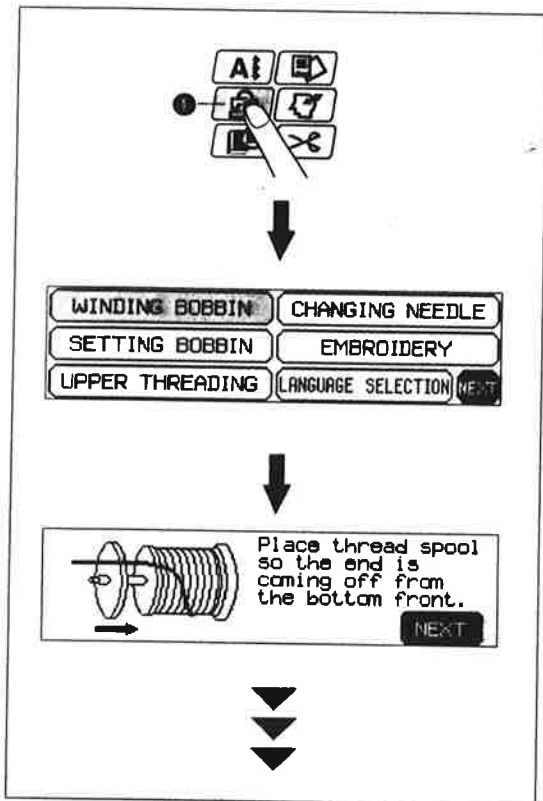

**Example: To find out how to wind a bobbin**

1. Press "BASIC OPERATION".
2. Touch "WINDING BOBBIN".

The operation procedure for winding a bobbin will be displayed.

- "BASIC OPERATION" key

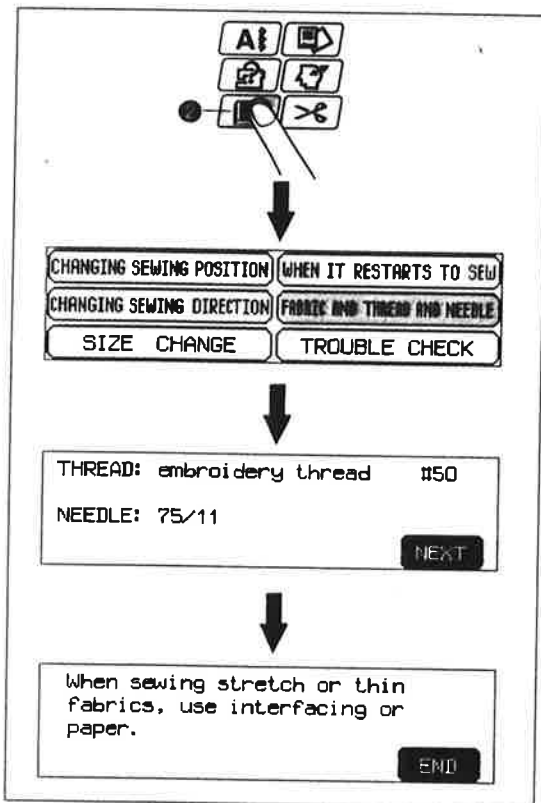

**Example: To find out the combination of fabric, needle and thread**

1. Press "MODIFY & ADVISE".
2. Touch "FABRIC AND THREAD AND NEEDLE".

- "MODIFY & ADVISE" key

## HOW TO USE THE LANGUAGE SELECTION KEY

You can use the "LANGUAGE SELECTION" key to easily change the display language for all the keys and messages on the LCD screen to the language you need.

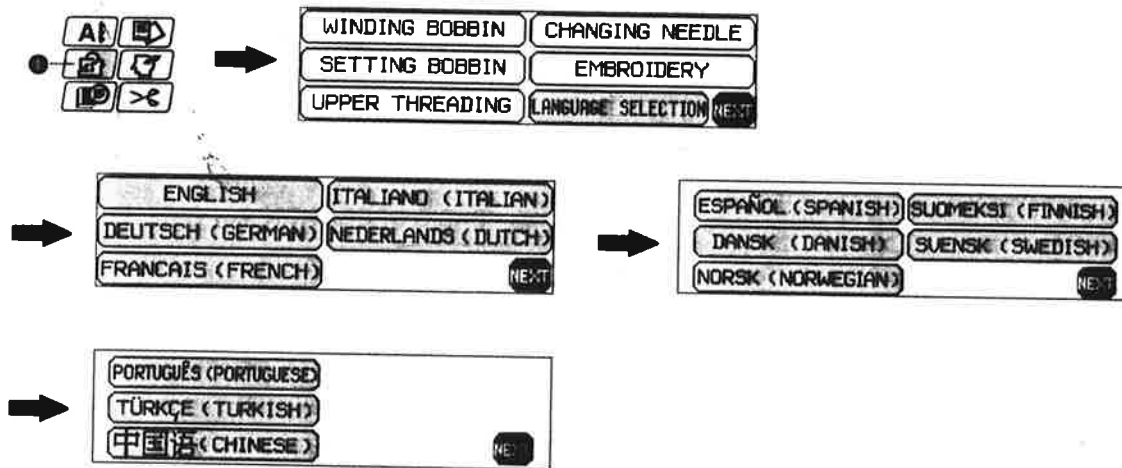

1. Press "BASIC OPERATION".
2. Touch "LANGUAGE SELECTION".
3. The language display screen will then appear. Touch the key which corresponds to the desired language.

\* You can move to the next screen by touching "NEXT".

● "BASIC OPERATION" key

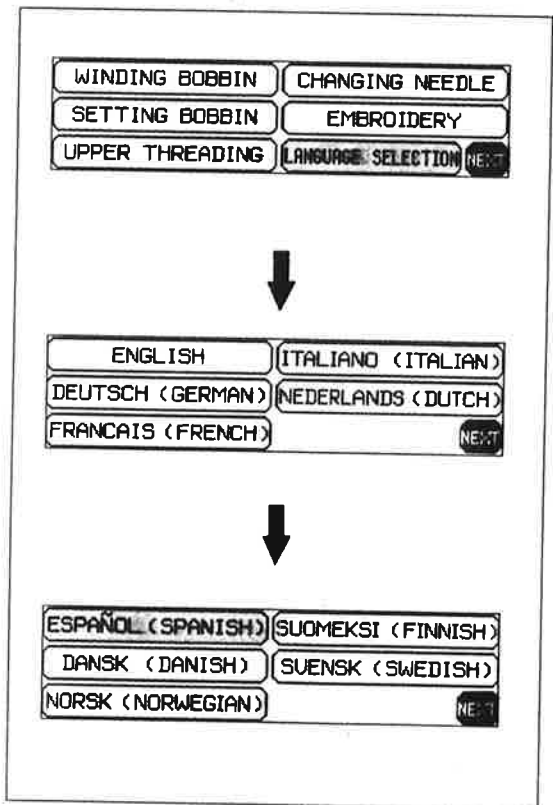

### Example: To change the display language to Spanish

1. Touch "LANGUAGE SELECTION".
2. Touch "NEXT".
3. Touch "ESPAÑOL (SPANISH)".  
This will change the language setting to Spanish.
4. The display will then return to the screen which was previously being displayed.

### NOTE

- \* When the "LANGUAGE SELECTION" is used to set the display language, error messages will also be displayed in the language selected.
- \* The display language can be selected from a list of 13 languages (English, German, French, Italian, Dutch, Spanish, Danish, Norwegian, Finnish, Swedish, Portuguese, Turkish and Chinese).

## How to clear the language selection.

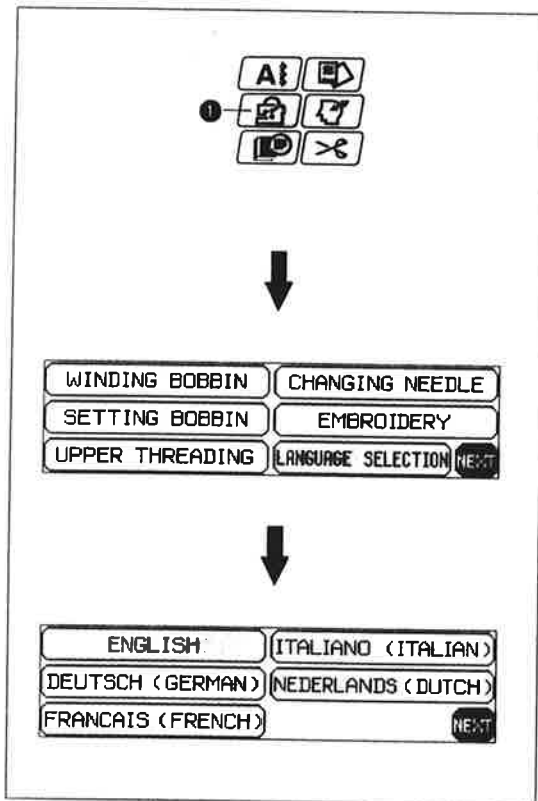

### Example: To change the display language from Spanish back to English

1. Press "BASIC OPERATION".
  2. Touch "LANGUAGE SELECTION".
  3. Touch "ENGLISH".
- This will cancel the Spanish language setting and return all screen displays and error messages to the English language.

- ① "BASIC OPERATION" key

### CAUTION

- This function can not be used as a translation function.
- If the power supply is turned off, the current language setting will be retained and will not be cleared.

# BOBBIN WINDING AND INSTALLATION

How to wind a bobbin and set the lower thread.

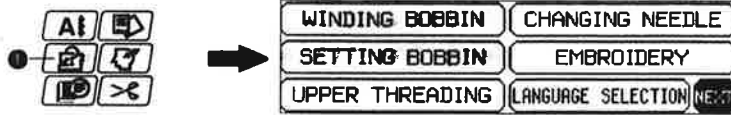

① "BASIC OPERATION" key

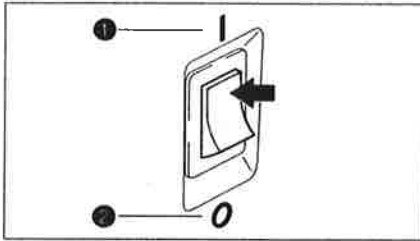
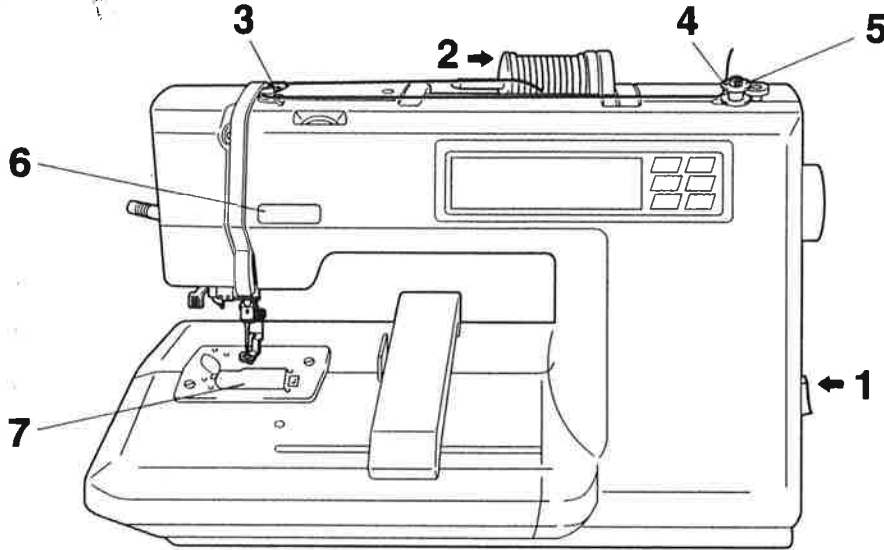

1. Connect the machine to the power supply and turn on the main power.

- ① ON
- ② OFF

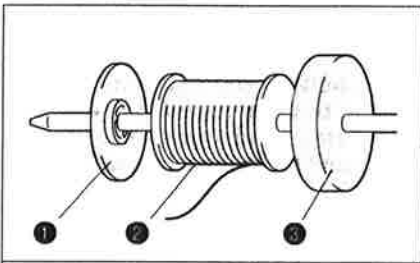

2. Set the thread spool. The thread end should come from the bottom front of the spool. The spool cap closest to the thread spool size should be used to hold the spool securely on the spool post.

\* The spool cap should be pushed on as far as it will go.

- ① Spool cap
- ② Spool
- ③ Spool felt

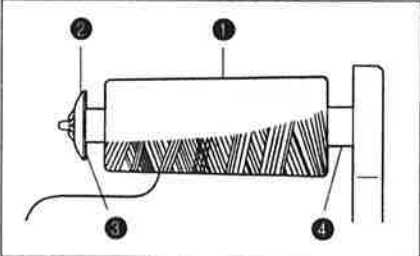

### NOTE

\* If using a fine thread such as cross wound thread, remove the spool felt and slightly separate the spool cap from the thread on the spool before using.

- ① Cross wound thread
- ② Spool cap (small)
- ③ Separate slightly
- ④ No spool felt

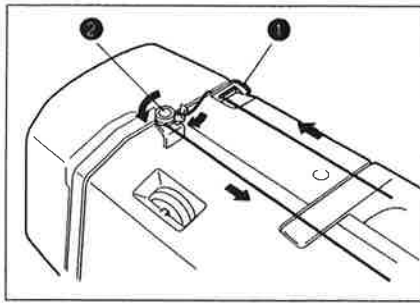

3. Hook the thread onto the thread guide plate and the bobbin thread winder guide, following the dotted line which is printed on the machine.

\* When hooking the thread onto the thread guide plate, hold the thread with both hands and slide it into the plate.

- ① Thread guide plate
- ② Bobbin thread winder guide

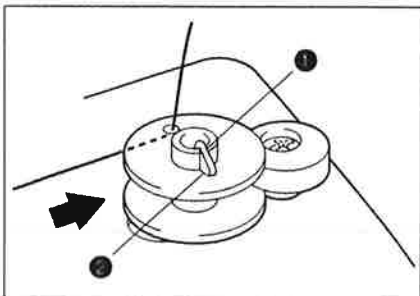
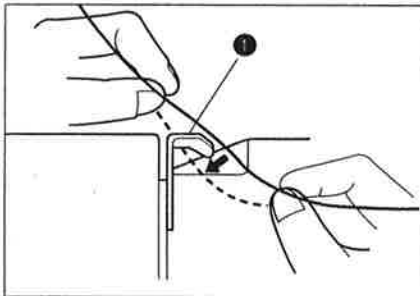

4. Guide the thread through the small hole in the side of the bobbin from the inside. Holding the thread end, push the bobbin winder shaft to right.

\* Match the groove of the bobbin with the spring on the shaft.

- ① Spring on the shaft
- ② Groove in the bobbin

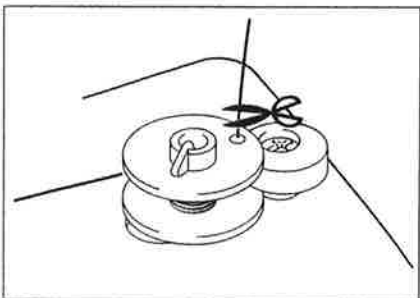

5. Holding the thread end, press the "START/STOP" button. Wind the thread a few times around the bobbin and press the "START/STOP" button again.

Trim the excess thread from the top of the bobbin after the machine stops.

\* It is important to trim the thread close to the spoolend.

6. Press the "START/STOP" button. The machine will stop automatically when the bobbin is full. Press the "START/STOP" button to stop at any time or when the bobbin has stopped moving and the motor is still running.

- ① "START/STOP" button

7. Push the bobbin shaft to the left. Remove the bobbin and continue sewing.

8. Set the bobbin into the shuttle as shown on page 15.

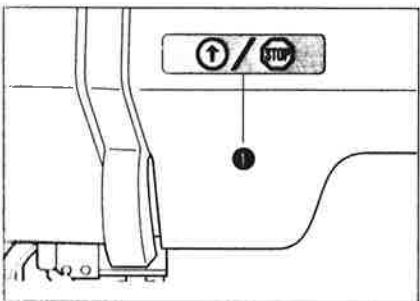

**It's a good idea to have several full bobbins on hand before start your project.**

## Setting the bobbin

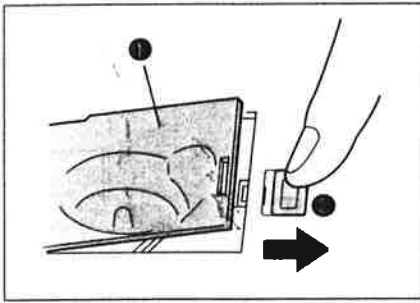

The bobbin cover is located in front of the needle plate.

1. Slide open the bobbin cover by pushing the bobbin release button to the right.

- 1 Bobbin cover
- 2 Bobbin cover release button.

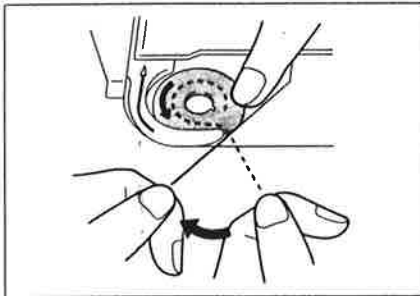

2. Insert the bobbin into the shuttle following the thread direction as noted in the etching under the bobbin cover.  
\* (Use a plastic bobbin as shown on page 6)

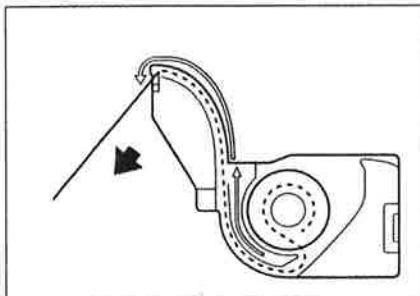

3. Guide the thread end around the finger through the channel toward the back, pulling the thread toward you which will cut off any excess.

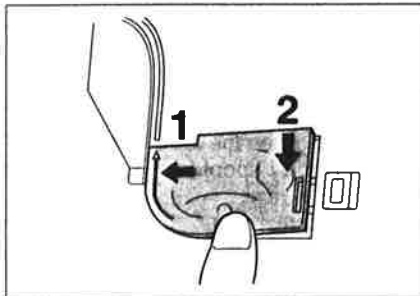

4. Close the bobbin cover by placing the left end in place and pressing down lightly on the right end to snap in place.

- \* There is no need to pull up the lower (bobbin) thread, it is done automatically.  
Embroidery can begin without pulling out the lower thread.



## UPPER THREADING

Thread according to the number and arrow marks on the machine.

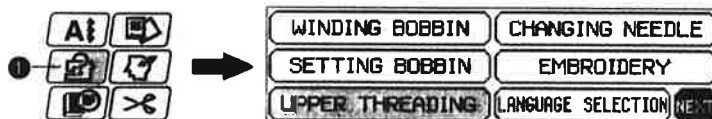

① "BASIC OPERATION" key

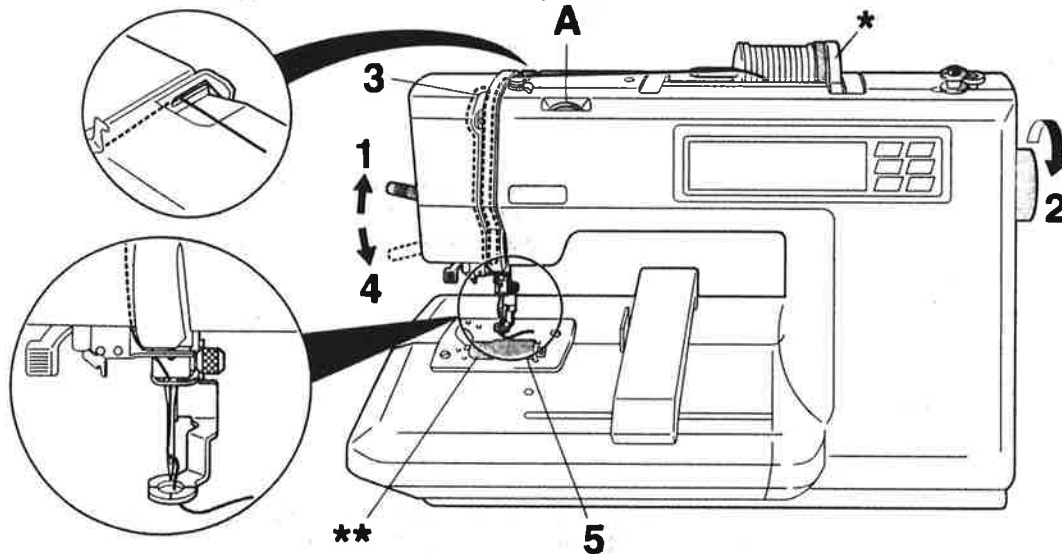

1. Raise the presser foot lever (If the presser foot is not raised, the upper thread cannot be threaded.)
2. Turn the balance wheel to raise the needle to its highest position.
3. Guide the thread as illustrated with the solid line on the machine following the number sequence.
4. Lower the presser foot.
5. Thread the needle using the auto needle threading device (See page 17) or manually.

\* Be sure the spool felt is behind the spool. (shown above \*)

\*\* You do not need to pull the lower thread up before you start embroidering.

### CAUTION

Always be sure to raise the presser foot before removing the upper thread to prevent damage to the thread tension system.

### USING THE EXTRA SPOOL PIN AND NET

#### Extra spool pin

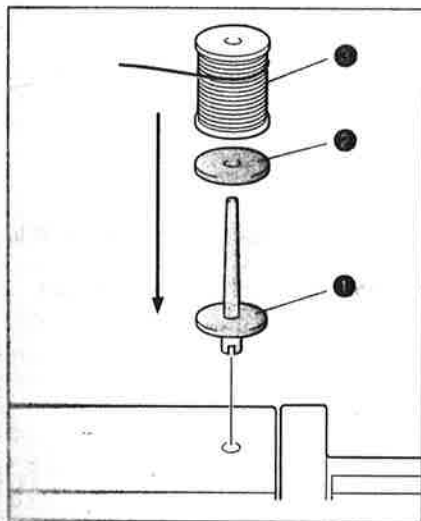

Use when embroidering with metallic thread.

1. Insert the extra spool pin into the hole on the top of the machine.
2. Install the spool felt and the thread spool in that order, and then thread the upper thread.

- \* Do not thread the thread onto bracket (A).
- \* When sewing using the metallic thread, set thread tension control dial (B) to the "0" position.
- \* When setting the thread spool, set it so that the thread winds off from the front of the spool.
- \* If using metallic thread, we recommend that you use a 90/14 home sewing machine needle.

- ① Insert the extra spool pin into the hole on the top of the machine
- ② Spool felt
- ③ Thread spool

### NOTE

This method keeps the thread from twisting as it comes off the spool pin.

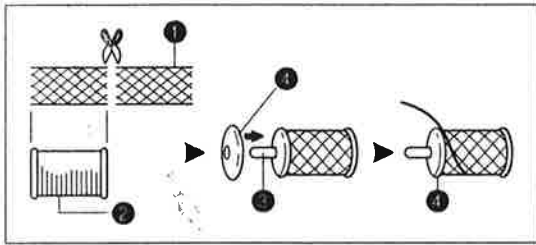

### Net

If using special threads which wind quickly off the thread spool, attach a net to the spool before using.

- \* Cut the net to match the size of the spool.

- ① Net
- ② Thread spool
- ③ Spool pin
- ④ Spool cap

### Auto needle threading device

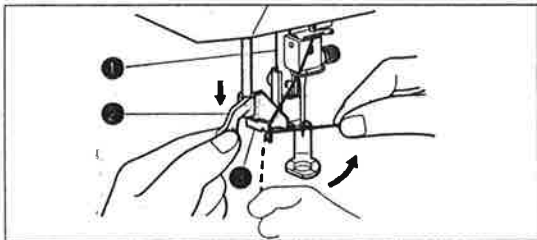

1. Guide the thread through the wire loop thread guide (number "6") and gently pull the thread towards you.
2. Lower the presser foot.
3. Lower the needle threader lever until it stops. Hook the thread into the guide and pull it across to the right.

- ① Wire loop thread guide
- ② Needle threader lever
- ③ Guide

- \* The needle threading device cannot be used while the needle is lowered.

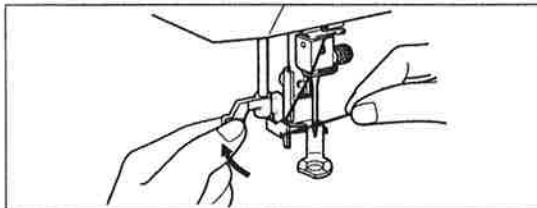

4. Push the needle threader lever toward the back. Check to be sure that the hook has passed through the eye of the needle and route the thread under the metal guides and the hook.
- \* Pull the thread toward you and check that it is being held by the thread hook.

- ① Hook
- ② Metal guides
- ③ Thread correctly under the metal guides and the hook.

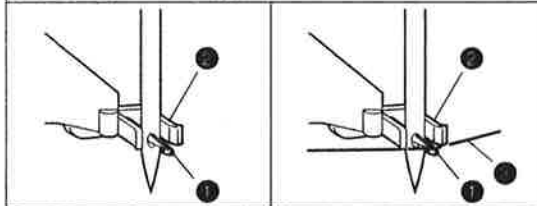

5. While gently holding the thread, pull the needle threader lever forward.

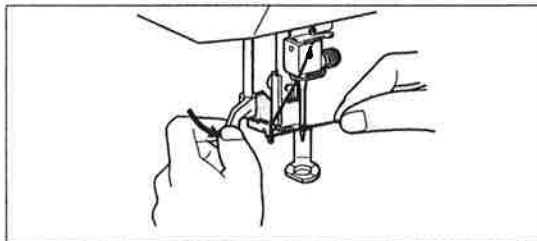

6. Release the thread from the needle threader lever.
7. Pull the upper thread through the needle eye toward the rear of the machine.

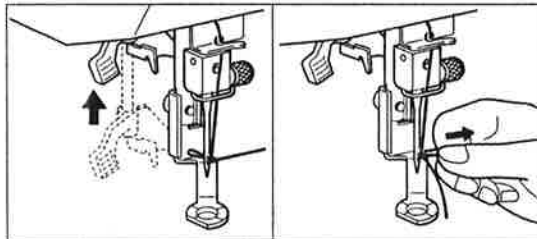

## PREPARATION BEFORE EMBROIDERING

Be sure to turn off the power before carrying out the following.

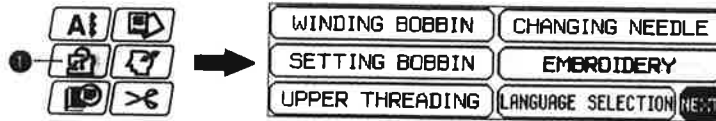

1 "BASIC OPERATION" key

### Attaching stabilizer material

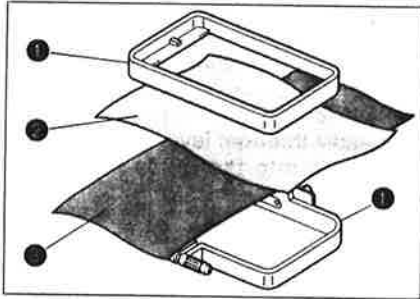

Attach a stabilizer material to the reverse side of the area of fabric to be embroidered.

It is not necessary to attach a stabilizer material to fabric which is already sufficiently stiff. For thin, knit and stretch fabric which may move in the frame, attach the fabric to a non-woven stabilizer material before embroidering.

The stabilizer material should be framed along with the fabric for the best results.

There are many types of non-woven stabilizers available on the market. The goal of the stabilizer is to prevent stretch or movement of the fabric. Best results for stretch, knit or light weight fabrics will be obtained by using a light weight non-woven iron-on stabilizer.

- 1 Embroidery frame
- 2 Fabric
- 3 Non-woven stabilizer material

### Embroidering different types of fabric

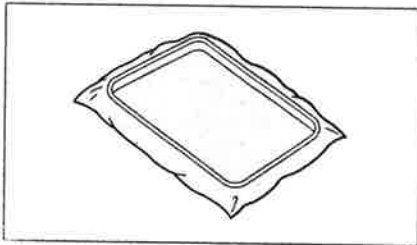

From normal fabrics to thick fabrics

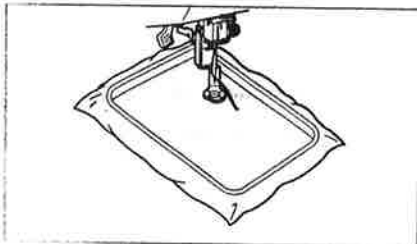

It's a good idea to place a piece of stabilizer fabric under (not within) the frame holding the fabric being embroidered.

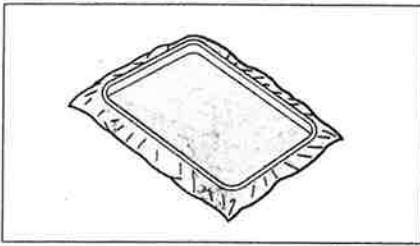

**Thin fabrics such as organza or cotton batiste.**

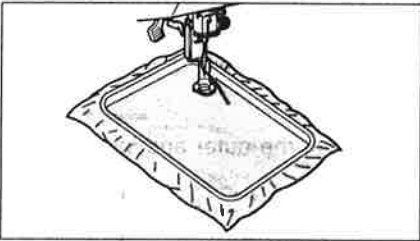

After selecting your fabric, place a piece of stabilizer fabric within the frame beneath the fabric being embroidered. We also recommend using a spray-on stabilizer first, allow it to dry or iron to dry then use a non-woven stabilizer with it in the frame.

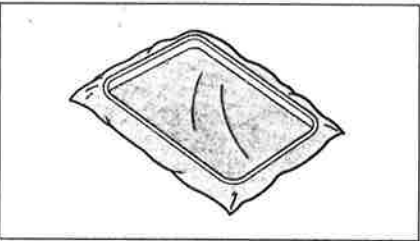

**Stretchable fabrics such as jerseys**

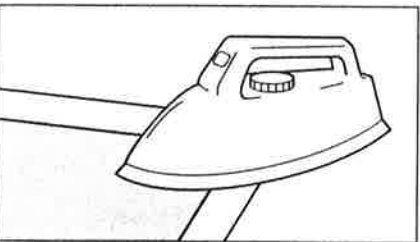

Adhere a piece of iron-on stabilizer material which is slightly larger than the frame onto the fabric to be embroidered, and then stretch it over the frame area.

\* X80940-001

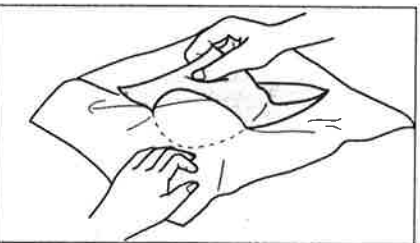

A stabilizer material that can be torn away without affecting the embroidering is ideal.

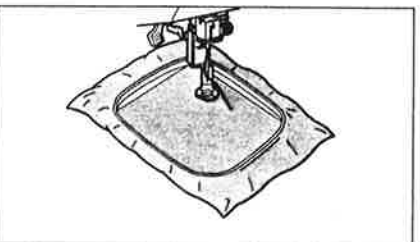

Use the smallest frame possible that can still accommodate the pattern being embroidered, as this will give better results.

## Setting the fabric in the embroidery frame

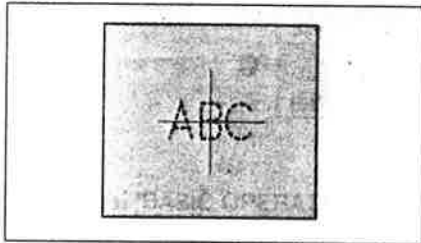

1. Make a mark on the fabric with chalk or marking pencil indicating the center of the area to be embroidered.

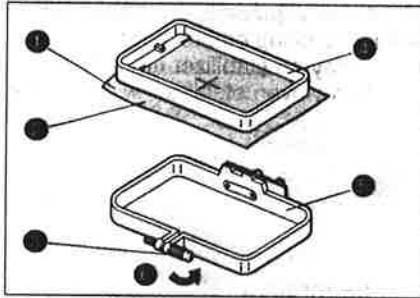

2. Loosen the adjusting screw of the outer frame, place the fabric on top of the outer frame with the right side of the fabric up; and then place the inner frame into the outer frame to clamp the fabric.

\* Make sure that the ▼ marks of the outer and inner frames are aligned.

- ① Fabric
- ② Right side surface for embroidering
- ③ Adjusting screw
- ④ Inner frame
- ⑤ Outer frame
- ⑥ Loosen

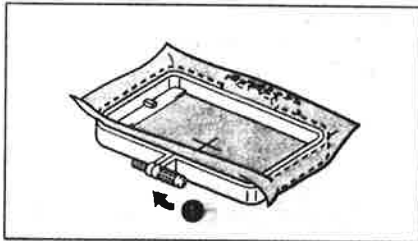

3. Firmly tighten the adjusting screw, and then temporarily remove the fabric and the inner frame from the outer frame.

- ⑥ Tighten

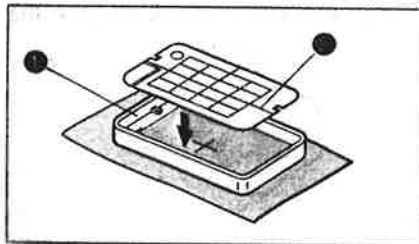

4. Place the embroidery sheet on top of the inner frame so that the center crosshairs on the embroidery sheet and the mark on the fabric are aligned.

- ① Inner frame
- ② Vertical + horizontal crosshair lines

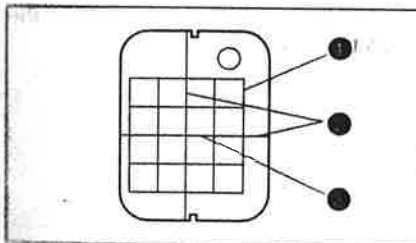

- ① Area available for embroidering
- ② Vertical + horizontal crosshair lines
- ③ Center of the crosshairs and the pattern

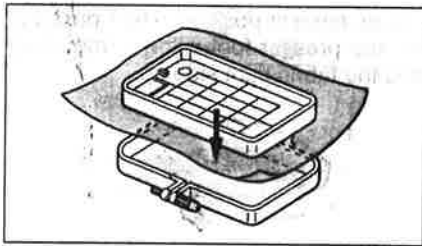

5. Insert the fabric and inner frame back into the outer frame while ensuring that the mark on the fabric does not slip out of position.

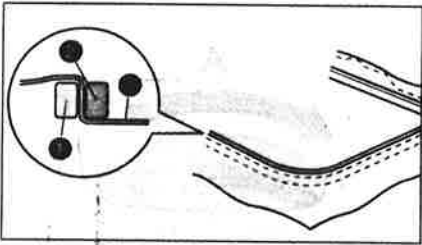

**Correct setting:**

\* Clamp securely so that the edges of the outer frame and inner frame are even.

- Outer frame
- Inner frame
- Fabric

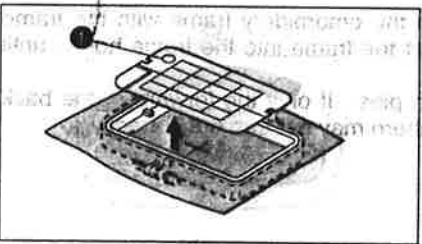

6. Check to be sure that the center of the design is in the correct location based on the crosshairs of the embroidery sheet. Remove the embroidery sheet using the finger hole to pull up.

- Finger hole for lifting

## Fitting the embroidery frame to the machine

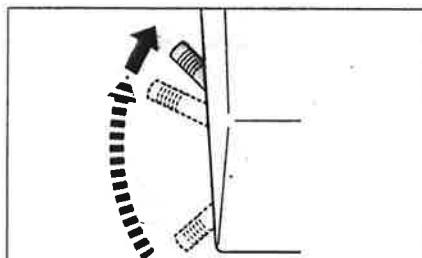

1. Raise the presser foot to its highest position. Then pass the embroidery frame under the presser foot with the mounting pins on the right side and the fabric right side up.

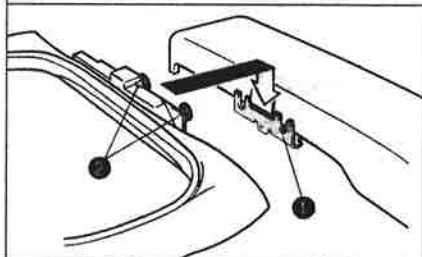

- 1 Frame holder
- 2 Pins

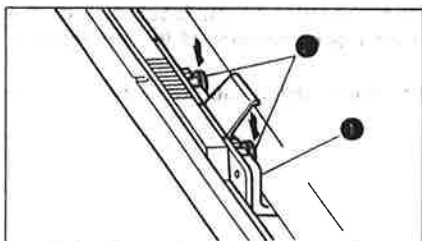

2. Align the two pins on the embroidery frame with the frame holder, and then insert the frame into the frame holder until a click is heard.  
\* Be sure to insert both pins. If only the forward or the back pin is inserted, the pattern may not turn out correctly.

- 1 Frame holder
- 2 Pins

## Removing the embroidery frame

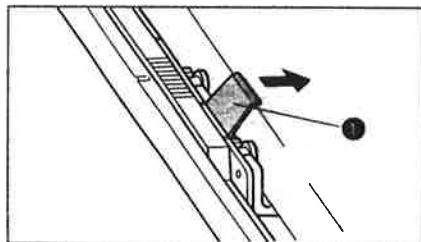

Push the release lever to the right and remove the embroidery frame by pulling up.

- 1 Release lever

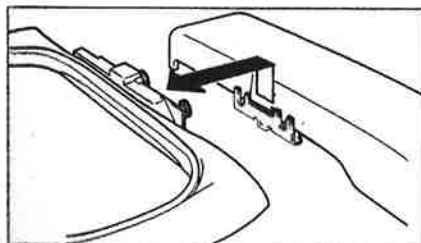

# THREAD TENSION ADJUSTMENT

Use this procedure when changing the thread tension.

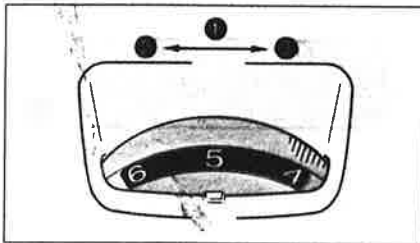

## Upper thread tension dial

- ① Upper thread tension setting
- ② Weak (Decrease thread tension)
- ③ Strong (Increase thread tension)

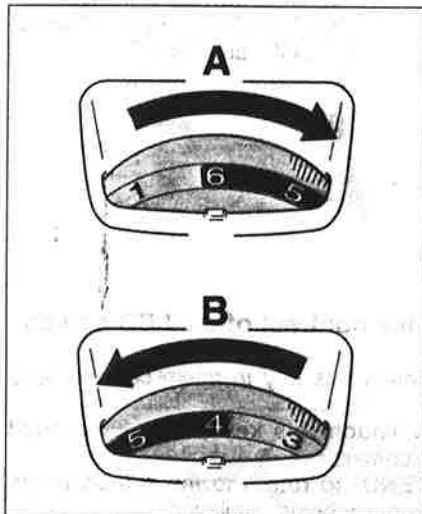

A- To tighten the upper thread tension, adjust the dial to the right.

B- To loosen the upper thread tension, adjust the dial to the left.

- \* The standard position is between "4" and "6". However, a sewing test should always be done to check for the proper thread tension.

Thread tension may need to be adjusted with the use of different thread, fabric or stabilizer fabric.

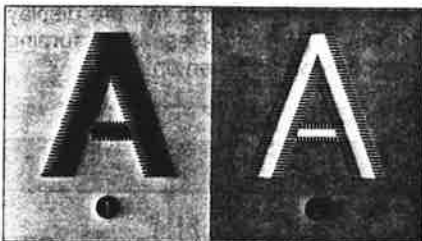

## Correct thread tension

Adjust so that the lower thread stitch width on the reverse surface of the fabric is about one-third of the total width. Correct tension is important because too much or too little tension will cause poor quality embroidery or your fabric to pucker.

- ① Top surface of fabric
- ② Reverse side of fabric

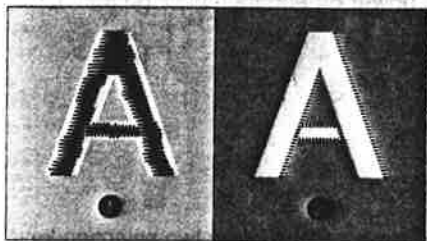

## If upper thread tension is too strong

The lower thread will be visible on top surface of the fabric. Decrease the upper thread tension.

- ① Top surface of the fabric
- ② Reverse side of the fabric

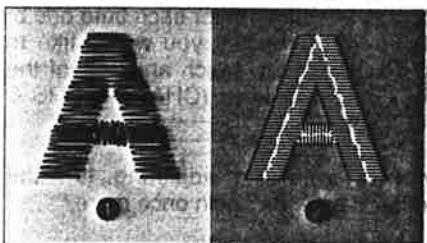

## If upper thread tension is too weak

The upper thread will be loose. Increase the upper thread tension.

- ① Top surface of fabric
- ② Reverse side of fabric



# ADJUSTING THE LCD SCREEN CONTRAST

To adjust the brightness of the LCD screen

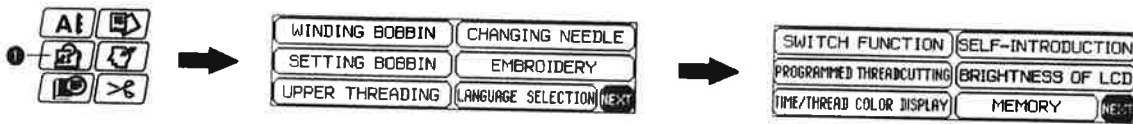

① "BASIC OPERATION" key

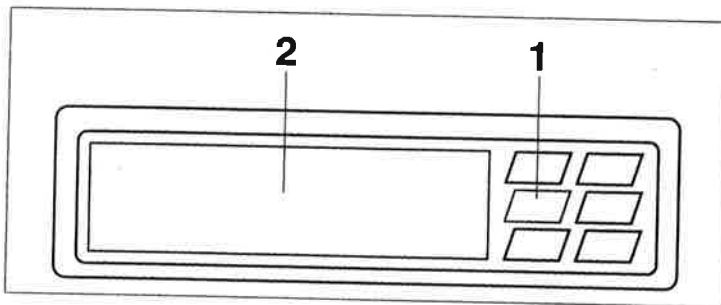

1. Press "BASIC OPERATION".
2. Touch "NEXT", "BRIGHTNESS OF LCD" and "NEXT".

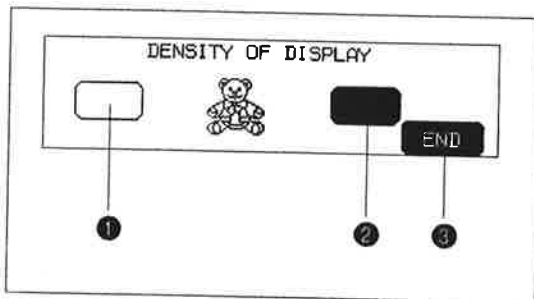

To adjust the contrast of the LCD screen

- ① "Dull" Touch this key to make contrast less (lighter).
- ② "Sharp" Touch this key to make contrast greater (darker).
- ③ Touch "END" to return to the screen which was previously being displayed.

\* If the contrast is adjusted too far, the display screen becomes invisible. Reset it by turning the power switch off and then on again.

If the LCD is hard to see when the power is turned on

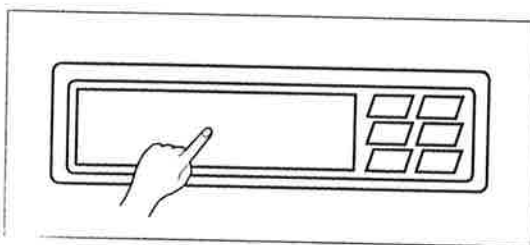

1. While touching the LCD (anywhere is OK), turn the power off and then back on again.

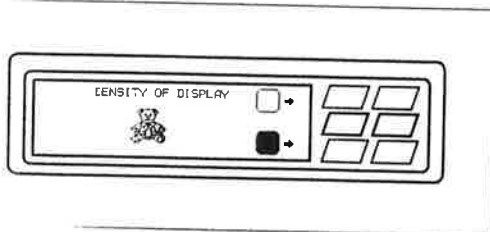

2. Touch any one of the lower two selection keys (MODIFY & ADVISE, THREAD CUTTER). The LCD will become darker each time one of these keys is touched. If you would like to make the LCD lighter, touch any one of the upper two selection keys (CHARACTERS & DESIGNS, CARD).
3. After you have finished adjusting, turn the power off and back on again once more.

# CHANGING THE NEEDLE

Set the needle securely.

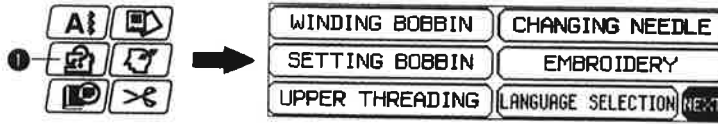

① "BASIC OPERATION" key

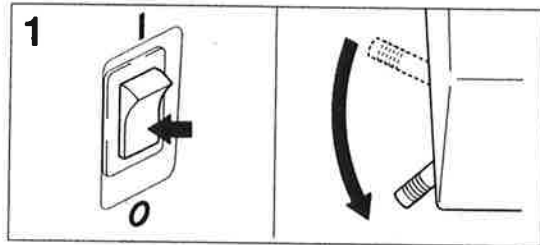

1. Turn the power switch off and lower the presser foot lever.  
Turn the balance wheel to raise the needle to its highest position.

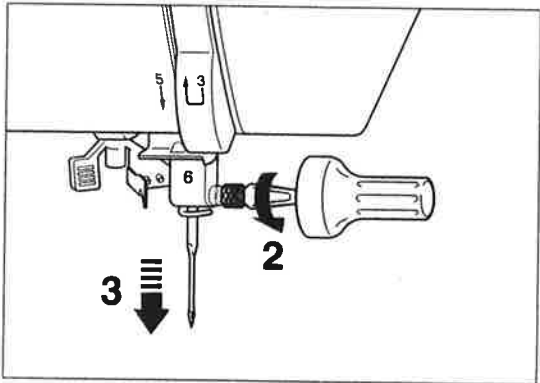

2. Loosen the needle screw with a screwdriver.
3. Slide the needle out.

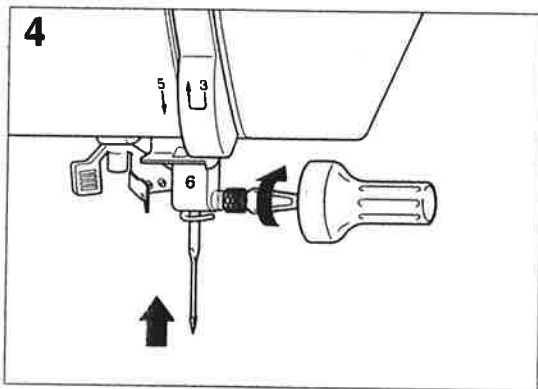

4. Insert the new needle into the needle shaft as far up as it will go with the flat side of the needle facing away from you. Secure it by firmly tightening the screw with a screwdriver.
5. Turn the power switch on.

Needle system: 130/705 H

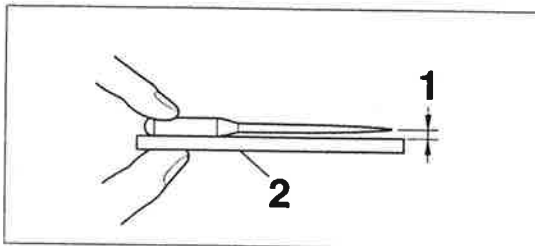

### Checking for a bent needle

- ① Place the needle on a flat surface and check whether the space is parallel or not.
- ② Flat surface  
(Needle-plate, glass, ruler etc.)  
If the space is not parallel then the needle is bent and should be thrown away to prevent damage to your project or the machine.



● "BASIC OPERATION" key

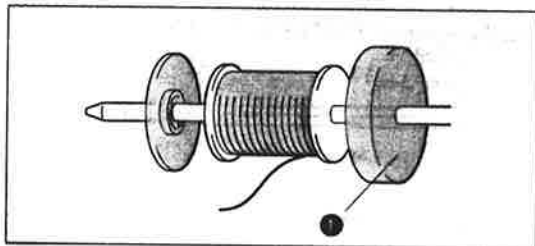
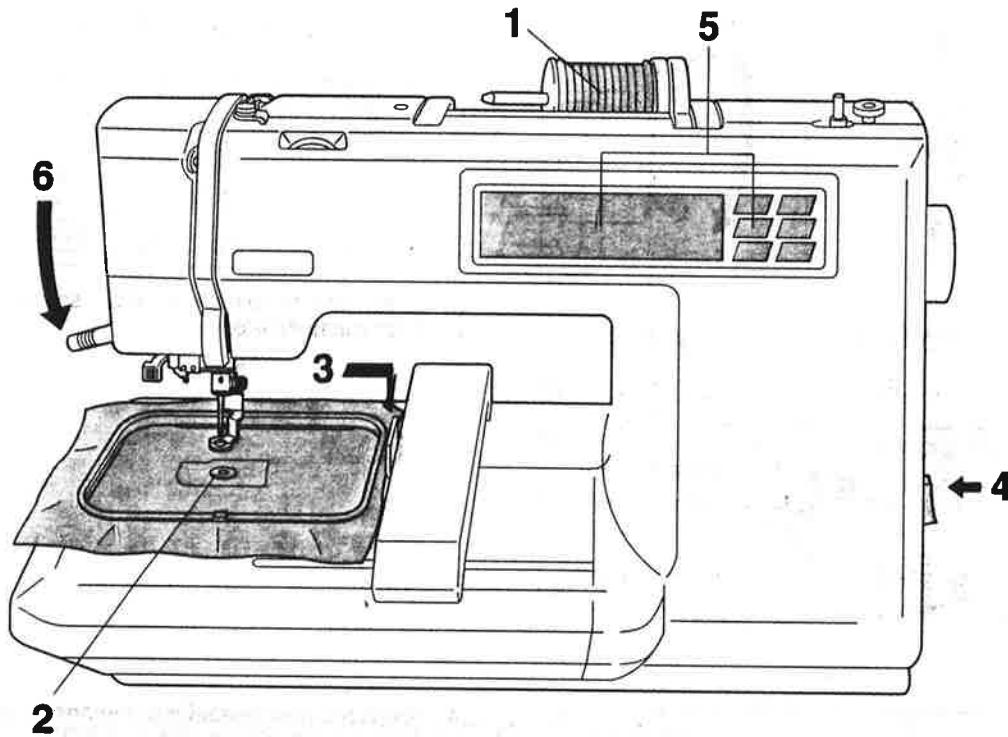

1. Thread the upper thread following the solidline and numerical sequence marked on your machine.  
Be sure to attach the spool felt as shown in the illustration.

● Spool felt (See page 16 – 17)

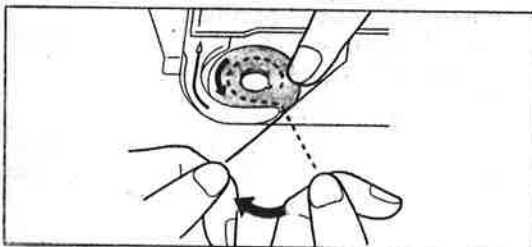

2. Thread the lower (bobbin) thread. (See page 15)

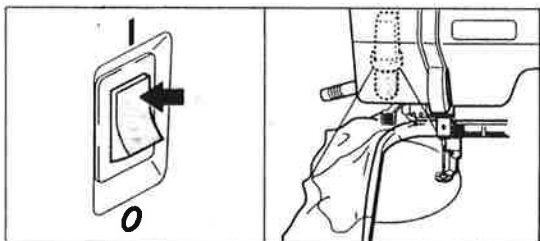
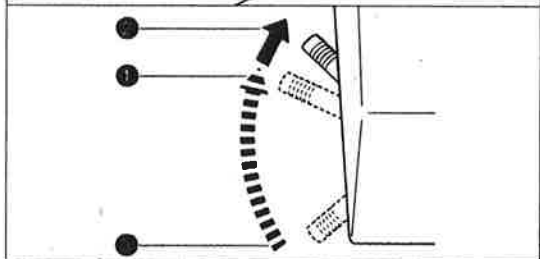
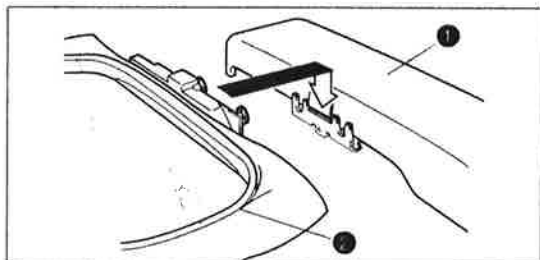

3. Place the fabric in the embroidery frame and then attach the frame to the machine.  
(See page 20 – 22)

- ① Carriage (embroidery arm)
- ② Embroidery frame

**NOTE**

Do not push down the carriage too hard as you attach the hoop. Use caution so as not to move the carriage sideways.

\* It is easier to move the embroidery frame under the presser foot if the presser foot lever is raised higher than its normal "up" position.

- ① Normal presser foot lever "up" position
- ② Presser foot lever pushed up
- ③ Presser foot lever down position

4. Turn on the power. The light will shine when the power is turned on.

5. Select a pattern.

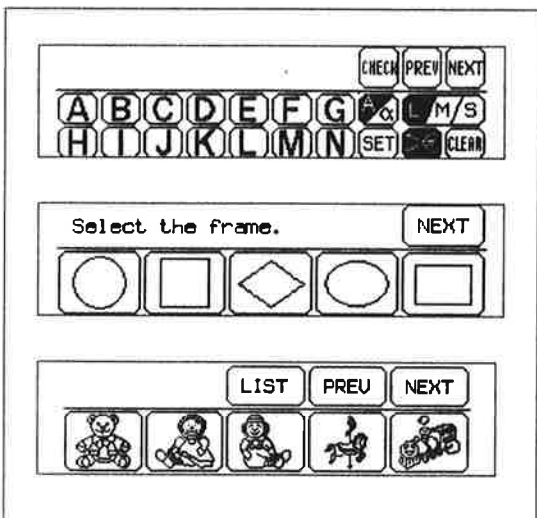

6. Lower the presser foot lever and press the "START/STOP" button to start the machine.

- ① "START/STOP" button

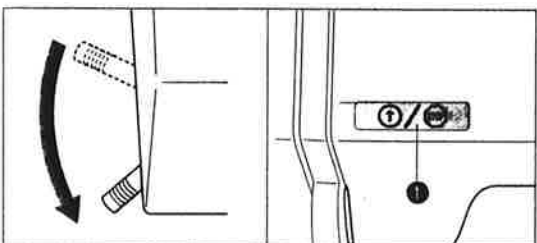

## Start embroidering

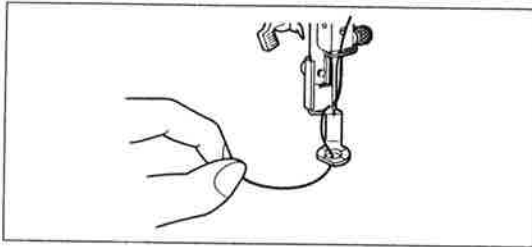

1. After threading the needle, pass the thread from the top to the bottom through the hole of the presser foot, and gently pull the end of the thread.

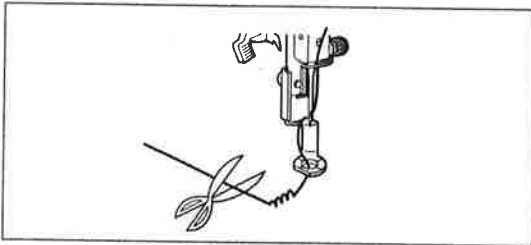

2. Lower the presser foot and press the "START/STOP" button to start the machine. After sewing 5 – 6 stitches, stop the machine and raise the presser foot again. Trim off any excess thread at the edge of the design. After trimming, lower the presser foot and press the "START/STOP" button again to start the machine.
3. The machine will stop sewing when it has completed all the stitching with the current thread color.

## Programmed automatic thread cutting

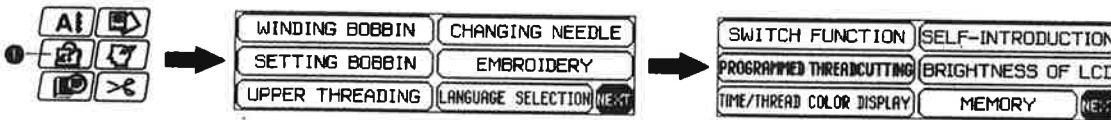

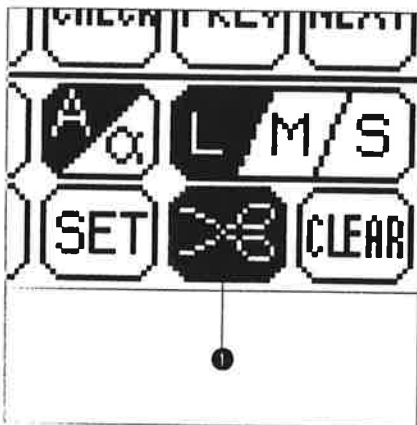

① "BASIC OPERATION" key



When programmed automatic thread cutting has been set, the thread is automatically cut after embroidering of each separate color is finished.

### Canceling programmed automatic thread cutting

Press the programmed automatic thread cutting key before embroidering starts. The display will change from  to .

① Programmed automatic thread cutting key

\* If you press the programmed automatic thread cutting key once more so that  appears in the display, programmed automatic thread cutting will be carried out again.

## Using the "THREAD CUTTER" key

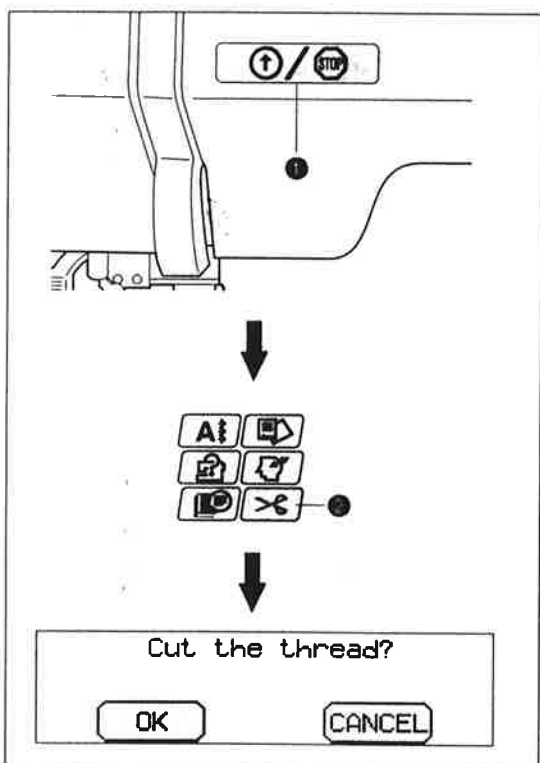

Use the "THREAD CUTTER" key when you would like to cut the thread automatically while embroidering.

1. Press the "START/STOP" button to stop the machine.
2. Press "THREAD CUTTER".
3. Touch "OK". The thread will then be cut.

- ① "START/STOP" button.
- ② "THREAD CUTTER" key.

## Embroidering advice

Thread	Needle
Embroidery thread #50	Home sewing machine needle 75/11, 80/12

- \* The recommended lower (bobbin) thread is #60 – #90 synthetic thread.
- \* For thin and stretch fabrics which are difficult to embroider, attach the fabric to non-woven stabilizer fabric before embroidering.
- \* If embroidering on a thick fabric with stabilizer (see page 18), it is recommended that a stronger 90/14 home sewing machine needle be used.

## HOW TO SELECT PATTERNS

### Selecting built-in embroidery patterns

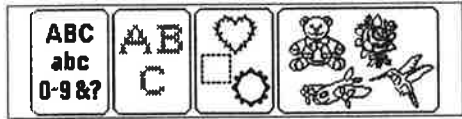

#### A

Select the type of built-in embroidery patterns you wish to embroider.

- \* If the power is turned on without a memory card inserted, the display shown at the left will appear.

#### B

- \* If the power is turned on with a memory card inserted, the screen corresponding to the memory card will appear. (Example: No.2 The Flower card)  
To select built-in patterns press the "CHARACTERS & DESIGNS" key.

- ① "CHARACTERS & DESIGNS" key

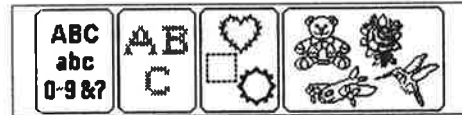
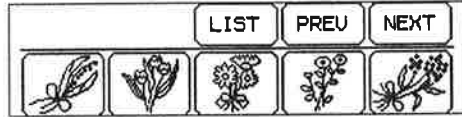

## Selecting alphabetic characters

### Alphabetic characters



Three different fonts are available for alphabetic characters. Touch the key that corresponds to the typeface you would like to use.

**Example: To select the characters to form the word "BUS"**

1. Touch "ABC abc 0-9 &?".

2. Touch "B".

3. Touch "NEXT".

4. Touch "U".

5. Touch "S".

① Screen A – The operation of each key shown on this screen is described on the following page.

The sequence of screenshots illustrates the following steps:

- Initial screen with font selection buttons: "ABC abc 0-9 &?", "A B C", and decorative icons.
- After touching the first font button, the screen shows "B" in the input field and a keyboard with "NEXT" highlighted.
- After touching "NEXT", the screen shows "BU" in the input field and a keyboard with "S" highlighted.
- After touching "S", the screen shows "BUS" in the input field and a keyboard with "S" highlighted. A circled "1" points to the "S" key.



Screen A

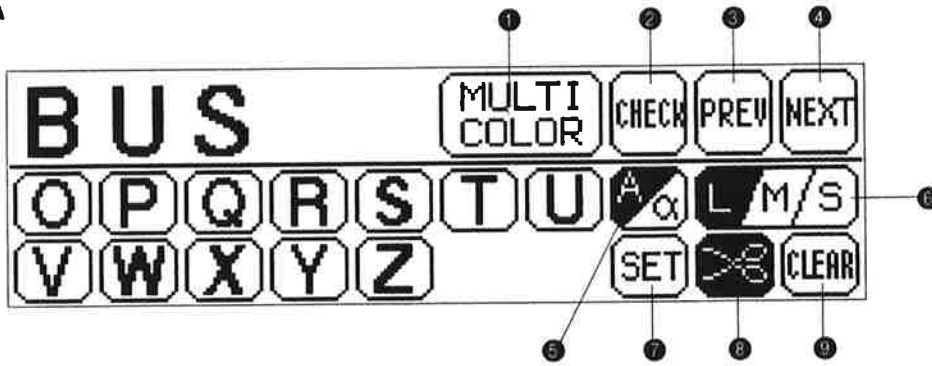

- 1 Touch this key to have the machine sew a reinforcement stitch and stop for the changing of thread each time a new character is embroidered. (Refer to page 34.)
- 2 Touch this key to check the character selected. (Refer to page 34.)
- 3 Touch this key to return to the previous screen character choices.
- 4 Touch this key to display the next character screen in the sequence.
- 5 Touch this key to switch between uppercase and lowercase. (Refer to page 32.)
- 6 Touch this key to change the character size to one of three different sizes. (Refer to page 33.)
- 7 Touch this key if you would like to change the character position, character size and thread density, or if you would like to use the Help function.  
 To change the character position: (Refer to page 43)  
 To change the character size: (Refer to page 47)  
 To change the thread density: (Refer to page 47)  
 To use the Help function: (Refer to page 54)
- 8 Touch this key to set and cancel programmed automatic thread cutting. (Refer to page 28.)
- 9 Touch this key to clear the selected characters one by one. (Refer to page 33.)

Uppercase & lowercase

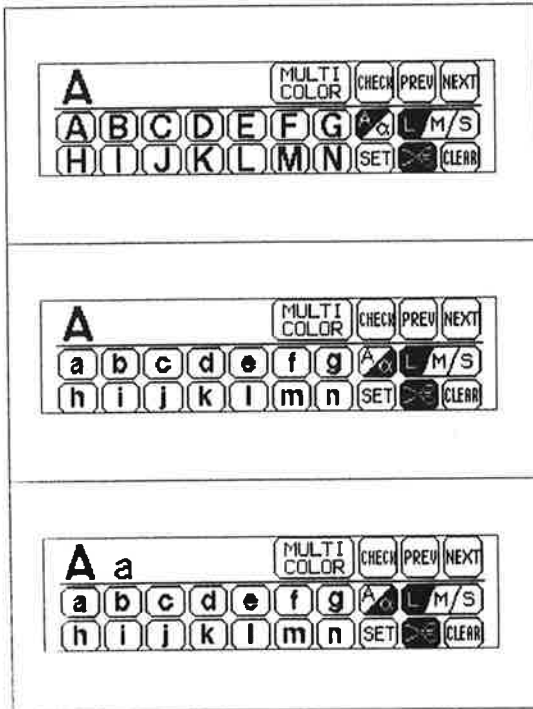

The characters to be selected can be switched from uppercase to lowercase and vice versa by touching "A/a".

1. Touch "A".
2. Touch "A/a" to switch to lowercase.
3. Touch "a".

## Changing the character size to one of three different sizes

L/M/S



The size of the characters can be changed by touching the "L/M/S" key. Each time it is pressed it changes as shown below. (L → M → S → L → ...)  
The size of all characters will be changed to the last character size selected.

### ALPHABETIC CHARACTERS

#### Actual size

- ① Large (L)
- ② Medium (M)
- ③ Small (S)

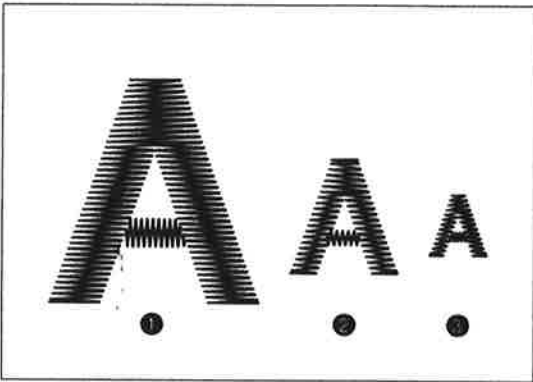

## Correcting characters

CLEAR



One character can be cleared with a backspace each time "CLEAR" is touched.

**Example: If "Giel" has been entered instead of "Girl".**

1. Touch "CLEAR" twice.

2. Enter the correct characters.

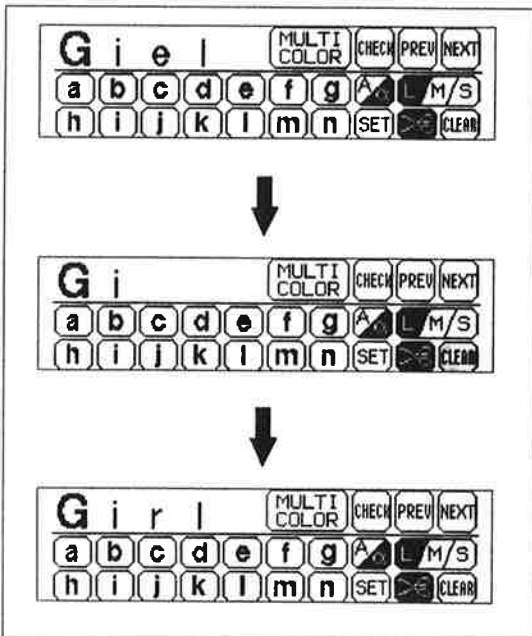

## Checking the characters input



Touch "CHECK" to check the characters which have been selected.

**Example:** If the characters "abcdefghijkl" have been selected in lowercase characters

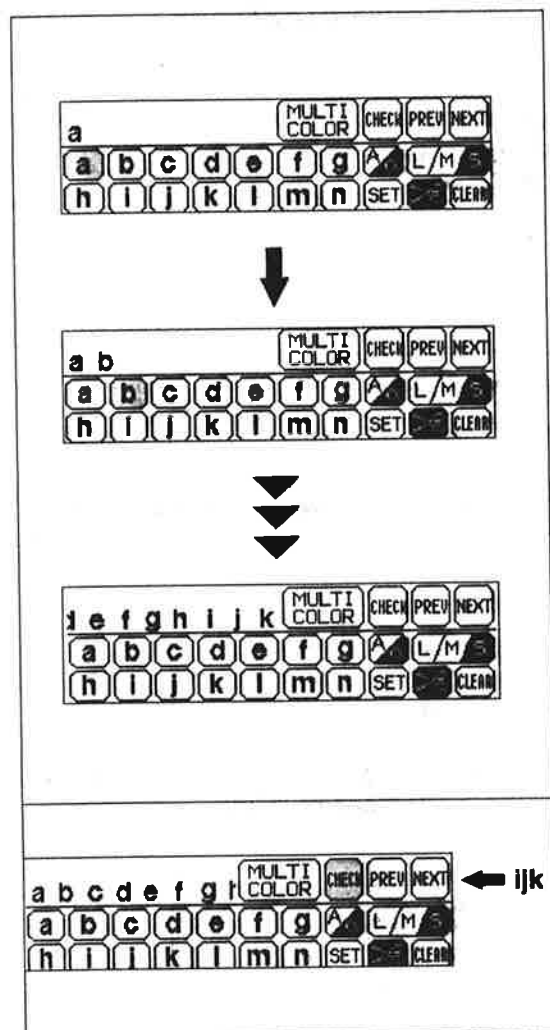

The display appears as shown in the illustration at left after the "k" is touched.

- \* The machine will not accept your next character if it exceeds the embroidery area. To continue the word or phrase change to a smaller size character.

By touching "CHECK", the display will scroll through all the characters from the first character selected.

- \* If all the characters selected appear on the display at once, then the display will not move.

## Changing the color of single characters



If "MULTI COLOR" is selected before embroidering starts, the machine will stop after each character is sewn so that you can change the thread.

## Selecting frame patterns

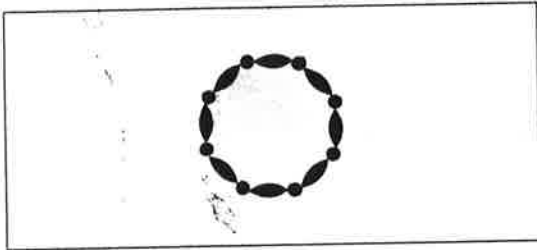

- \* Frame patterns are created by combining the desired frame and type of stitch.

### Example

1. Touch "  ".

- \* If another type of pattern such as characters or if a memory card has been inserted, press "CHARACTERS & DESIGNS" first and then touch "  ".

2. Select the desired shape for the frame.

- If you touch "NEXT", additional frame shapes will be displayed. (There are a total of 10 different frame shapes available.)

3. Select the desired type of stitch to form the frame.

- If you touch "NEXT", additional stitch types will be displayed. (There are a total of 12 different stitch types available.)

4. The combined pattern is then shown on the LCD screen.

- Screen A – The operation of each key shown on this screen is described on the following page.

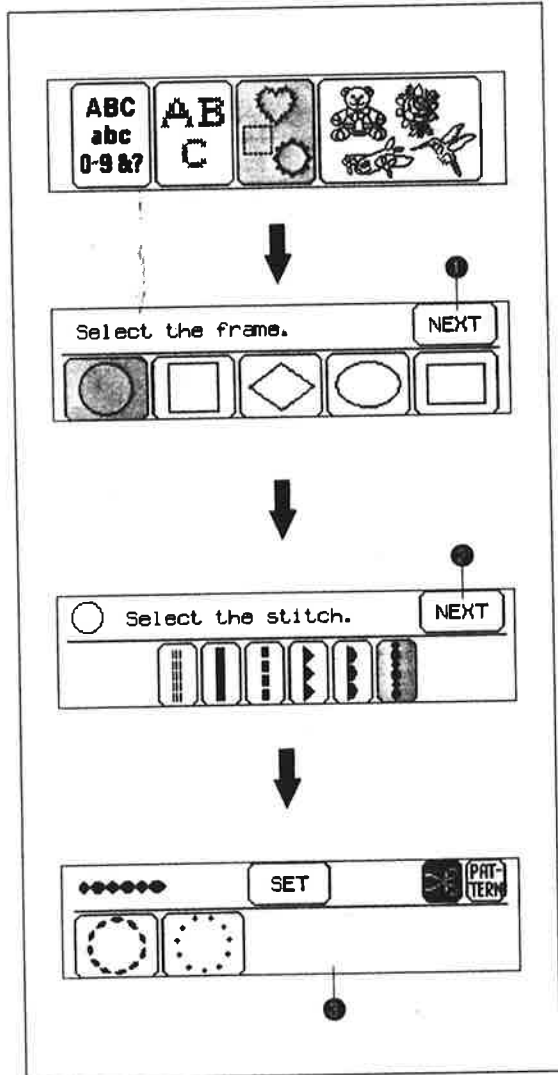

## Screen A

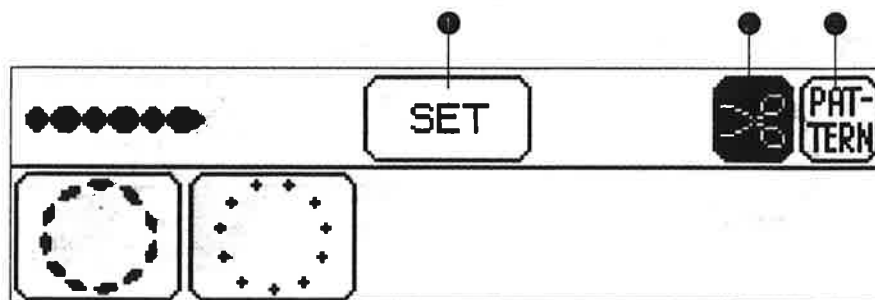

- Touch this key if you would like to change the pattern position, pattern size and thread density, or if you would like to use the Help function.
  - To change the pattern position: (Refer to page 43)
  - To change the pattern size: (Refer to page 47)
  - To change the thread density: (Refer to page 47)
  - (It may not be possible to change the thread density for some patterns.)
  - To use the Help function: (Refer to page 54)
- Touch this key to set and cancel programmed automatic thread cutting. (Refer to page 28.)
- Touch this key to return to the pattern selection screen.

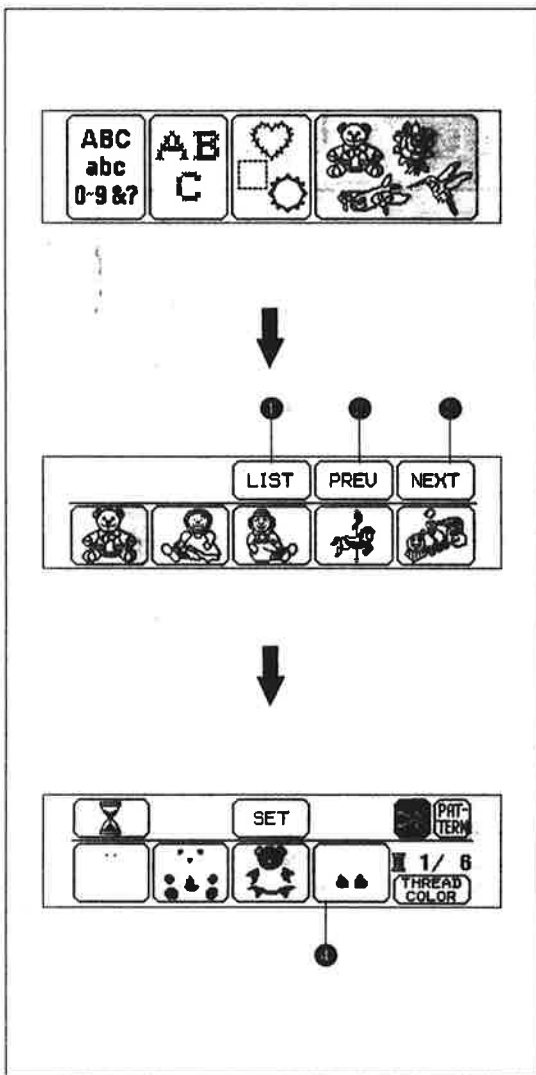
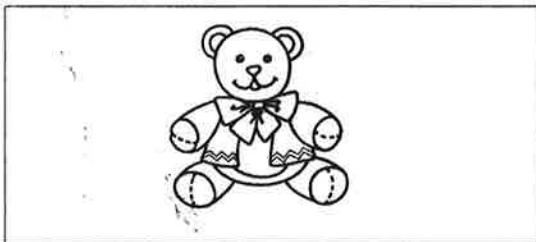

**Example**

1. Touch " ".

2. Select the desired pattern to be embroidered.  
(Example: Touch the teddy bear)

- Touch this key to display all available patterns on the screen. You can then select the desired pattern by touching it.
- Touch this key to return to the previous pattern screen.
- Touch this key to move to the next pattern screen.

3. The pattern is now selected.

- Screen A – The operation of each key shown on this screen is described on the following page.

**Screen A**  
(built in pattern)

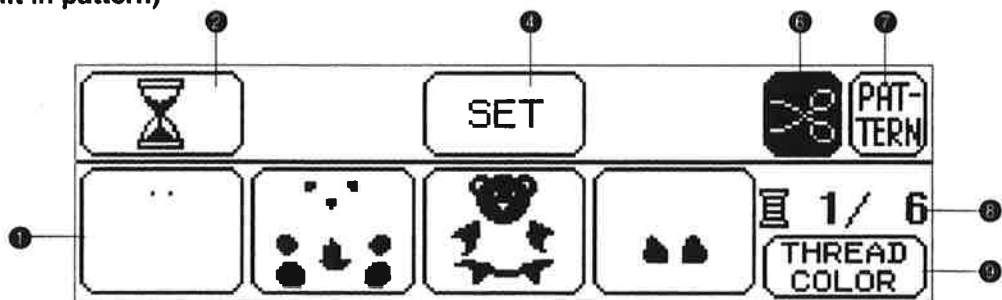

(memory card)

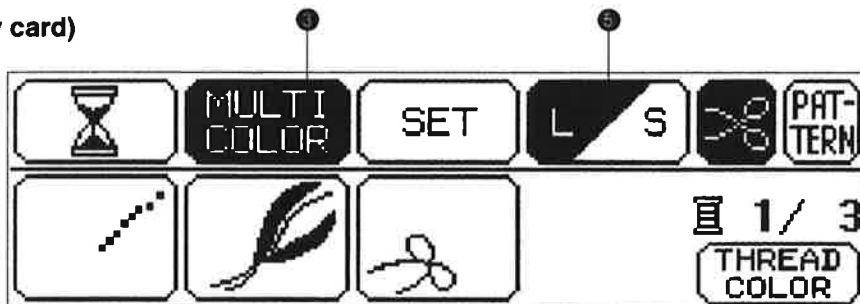

- ① This indicates the order of color changes.
- ② Touch this key to display the total time required for embroidering the pattern and the time remaining until the pattern is finished. The time taken to change the threads is not included in these times. (The time is calculated after the key is touched, and is then displayed.) (Refer to page 39.)
- ③ Touch this key to switch between the multicolor mode and single-color mode. (It is not possible to change between multi color mode and single color mode if "MULTI COLOR" is not displayed on the screen).
- ④ Touch this key if you would like to change the pattern position, or if you would like to use the Help function.  
To change the pattern position: (Refer to page 43)  
To use the Help function: (Refer to page 54)
- ⑤ Touch this key to change the size of the pattern. (It is not possible to change the size of patterns if "L/S" is not displayed on the screen.)
- ⑥ Touch this key to set and cancel programmed automatic thread cutting. (Refer to page 28.)
- ⑦ Touch this key to return to the pattern selection screen.
- ⑧ The total number of colors and the number of the color currently being sewn will be displayed.
- ⑨ Touch this key to change the display in ① to the color name (reference). (Refer to page 39.) ( It is not possible to display the color name if "THREAD COLOR" is not displayed on the screen.)

## Displaying the embroidery time for one-point patterns



① "BASIC OPERATION" key

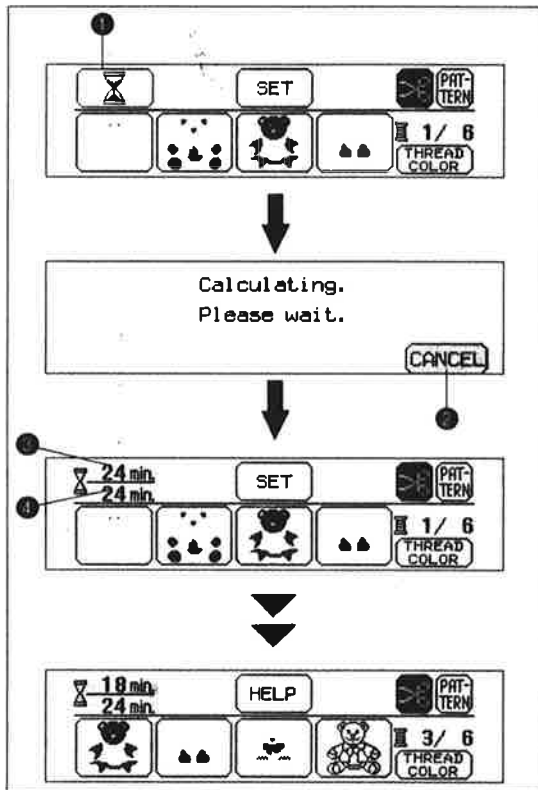

If you would like to know the time it takes to embroider a pattern, touch the time display key ("⌚"). The time required will then be calculated and displayed. The time taken to change the threads is not included.

This function can also be used with some of the patterns on the memory cards, but in such cases the time displayed may be somewhat different from the time given on the pattern sheet for that memory card.

1. After selecting the pattern, touch "⌚".
  - ① Time display key
2. The embroidering time will then be calculated.
  - ② Touch this key to cancel the calculation.
3. The required time and the remaining time will be shown on the display.
  - ③ Remaining time
  - ④ Total required time
4. The time remaining will change at the end of each color embroidery.

## Displaying the color names for one-point patterns



① "BASIC OPERATION" key

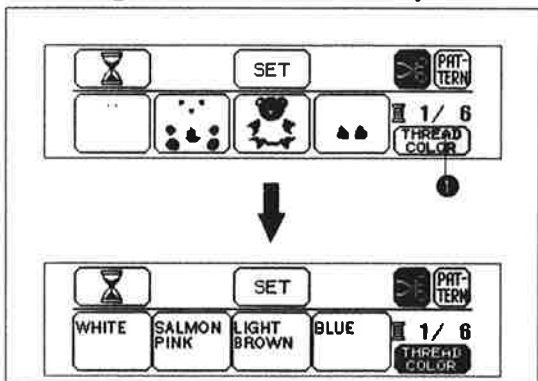

If you touch "THREAD COLOR", the color names (reference) of the different threads to be used will be displayed in order.

1. After selecting the pattern, touch "THREAD COLOR".
  - ① "THREAD COLOR" key
2. The color names will then be displayed.
  - \* If you touch "THREAD COLOR" once more, the display will return to the previous screen.
  - \* It is not possible to display the color name if "THREAD COLOR" is not displayed on the screen.



## Selecting patterns from a memory card

**Be sure to turn off the power switch before inserting or removing the memory cards.**

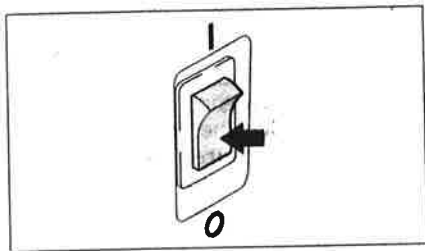

1. Turn the power switch off.

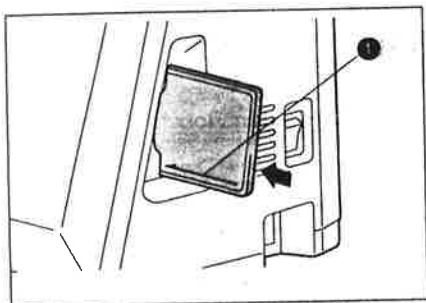

2. Insert the memory card into the card slot according to the direction of the arrow mark on the memory card.

● Direction arrow on memory card

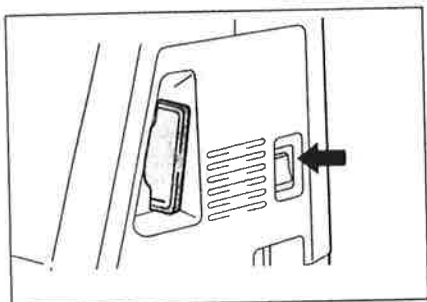

3. Turn the power switch on.

### IMPORTANT

- \* If the card is inserted in a direction other than that indicated by the arrow on the card, the connector in the card slot will become damaged.
- \* Insert so that the card appears as shown in the illustration at left. If you try to push the card in any further, the connector will become damaged.
- \* Be sure to turn the power switch off before removing the card. Pull the card straight out from the slot.
- \* Always keep the memory cards in their proper case when they are not in use.



4. The pattern selection screen for the inserted memory card will be displayed.  
(The illustration shows the pattern selection screen for the No. 2 Flower card.)  
The selection process from this point is the same as for selecting built-in patterns.

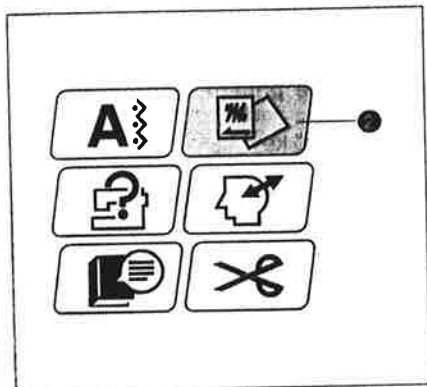

\* If you use a selection key to display another screen, you can return to the above pattern selection screen by touching "CARD".

● "CARD" key

# MEMORY

Up to 5 different pattern combinations can be saved and retrieved from memory.



① "BASIC OPERATION" key

## Saving a pattern combination in memory

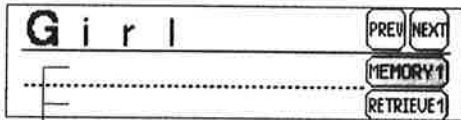

Saving

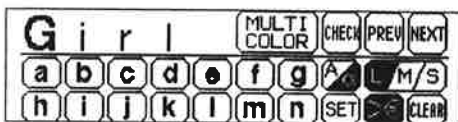

**Example: To save the "Girl" pattern in memory address 1.**

1. Enter the characters to form the word or monogram.

2. Press "MEMORY".

① "MEMORY" key

3. Touch "MEMORY 1".

● If any patterns have already been saved, they will be displayed on the screen. Touch "NEXT" to look for an empty memory space if MEMORY 1 has been used.

\* If the new pattern is saved to a space where an old pattern has already been saved, the old pattern will be deleted.

\* Do not turn off the power while a pattern is being saved (while "Saving" is displayed).

4. The pattern is now saved in memory.

5. For the next example press "CHARACTERS & DESIGNS", touch "M/S" to select desired font style and enter characters to create the pattern "Boy". Press "MEMORY", touch "NEXT" and "MEMORY 2" to save the pattern.

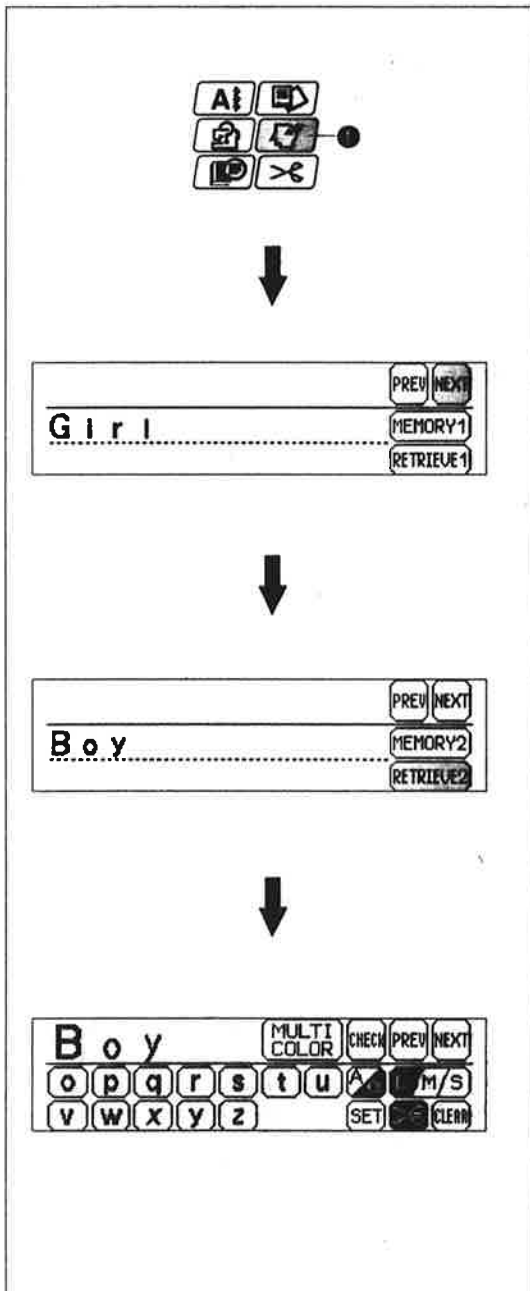

**Example: To recall the "Boy" pattern saved in memory space 2**

1. Touch "MEMORY".
- ① "MEMORY" key
  
2. Touch "NEXT".
  
3. Touch "RETRIEVE 2".
  
4. The pattern retrieved will appear on the screen.  
Press "START/STOP" button to embroider the pattern.

\* Patterns which are saved from an embroidery card can only be retrieved if the memory card containing that pattern has been inserted into the card slot of the machine.

## Moving the position (LAYOUT)

The position for embroidering the pattern can be changed by touching the "LAYOUT" key. This is useful if you want to embroider a pattern somewhere such as in the corner of the fabric or if you want to align a pattern away from the center of the embroidery area of frame.

### Character



### Frame pattern

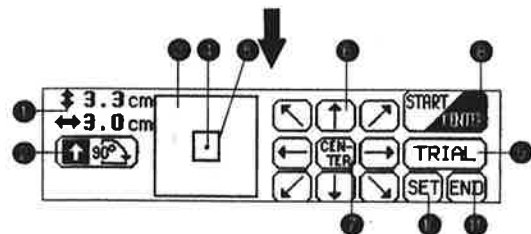
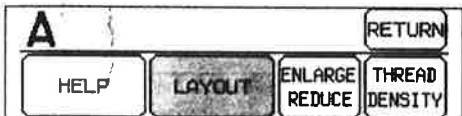
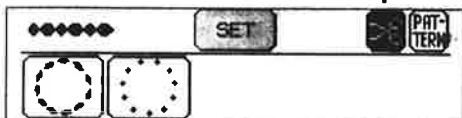

### One point

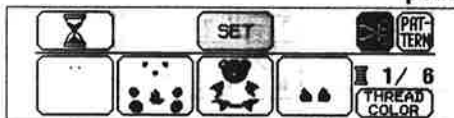

### Memory card (No.2 Flower)

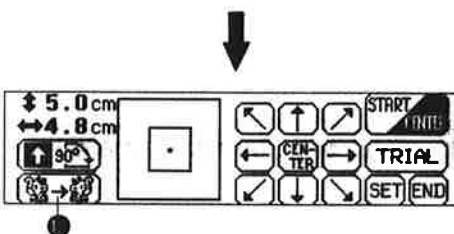
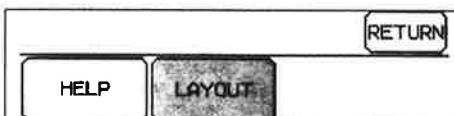

Touch "SET" and then "LAYOUT" to display the above screen.

- ① Indicates the current pattern size.

Note:

Characters and patterns may sometimes be displayed in slightly larger than actual size.

- ② Touch this key to rotate the selected pattern in 90° steps. (Refer to page 45)
- ③ Indicates the area which can be embroidered.
- ④ Indicates the current center needle drop position.
- ⑤ Indicates the embroidering position and embroidering area for the current pattern and size selected.
- ⑥ Touch these keys to move the embroidering position within the embroidery area. (Refer to page 44)
- ⑦ If you touch this key, the embroidering position will be returned to the center of the embroidery area.

- ⑧ This moves the needle position to the middle of the pattern or to the sewing start position. Use it when you would like to set the embroidering position. (Refer to page 45)
- ⑨ If you touch this key, the embroidery frame will move to trace the area required for the selected design, so that you can check the embroidering position. (Refer to page 44)
- ⑩ Touch this key to return to the previous selection screen.
- ⑪ If you touch this key, the display will change from the layout screen back to the original screen.
- ⑫ If you touch this key, the pattern will be reversed horizontally (mirror imaged). This function cannot be used with some patterns. (Refer to page 46)

## Changing the embroidery position:

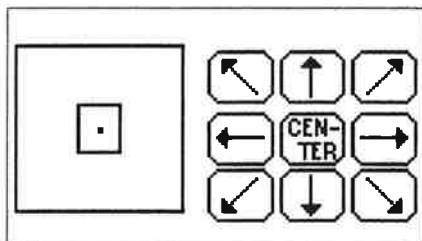

Touch the arrow key that corresponds to the direction in which you would like to move the pattern. The embroidery position will then move.

- \* If you touch the "CENTER" key, the embroidery position will return to the center.
- \* Use the hole on the embroidery foot as a guide, and never lower the needle while it is moving.

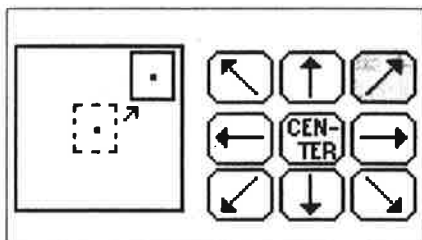

### Example: To move the embroidery position to the upper right corner

Touch the "↗" key.

- \* The embroidery position or area display can be moved by touching the corresponding arrow key. If the arrow key is touched once, the frame and display will move one step; if the key is touched continuously, the frame and display will move continuously.

## Checking the embroidery area:

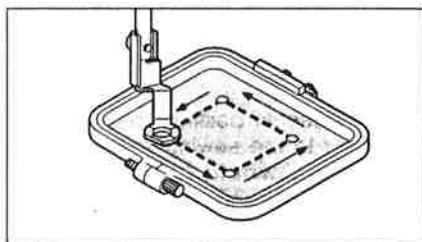

If "TRIAL" is touched, the embroidery frame will move and the presser foot will trace the embroidery area to be used for the currently selected pattern and size.

- \* Do not lower the needle. Use the hole of the presser foot as a guide instead.

## Embroidering from a specific starting point

LAYOUT

START

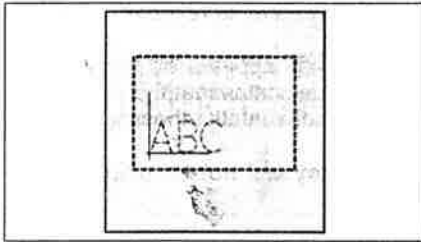

1. Make a mark at the starting position on the fabric in the frame as shown in the illustration. The mark cannot be too close to the edge of the frame as the presser foot prevents the needle from getting very close to the frame.

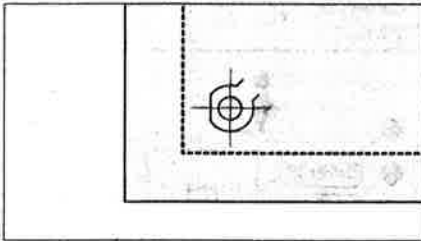

2. Touch "START/CENTER" to select "START" and then touch the arrow key to align the hole of the presser foot with the mark.

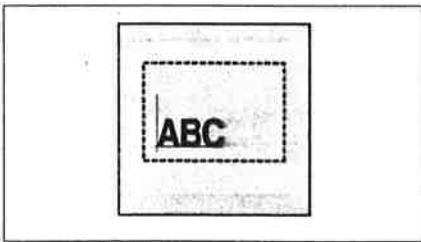

3. Embroider the pattern.

## Changing the pattern direction

LAYOUT

90°

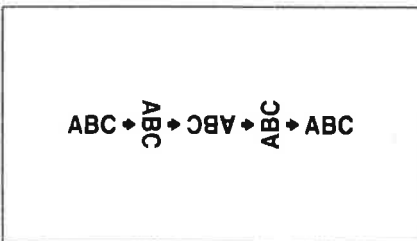
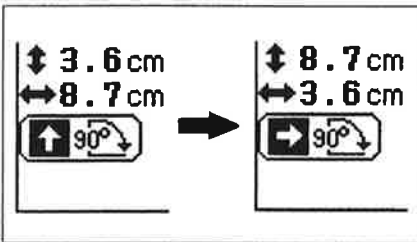



The pattern will be rotated clockwise in 90° steps as shown in the illustration at left each time "90° clockwise" is touched.

## Mirror imaging patterns

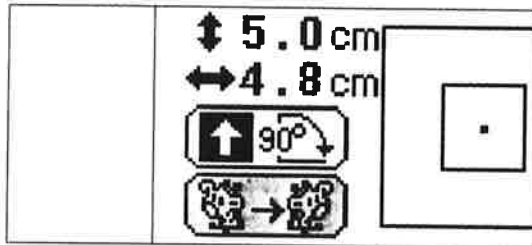
LAYOUT



1. Touch the "" key to reverse the pattern horizontally.

  - If the "" key appears on the display in reverse mode, it indicates that the pattern has been reversed horizontally showing a mirror image.
  - The "" key will not be displayed for some patterns.

## Changing the size of characters and frame patterns

SET

ENLARGE  
REDUCE

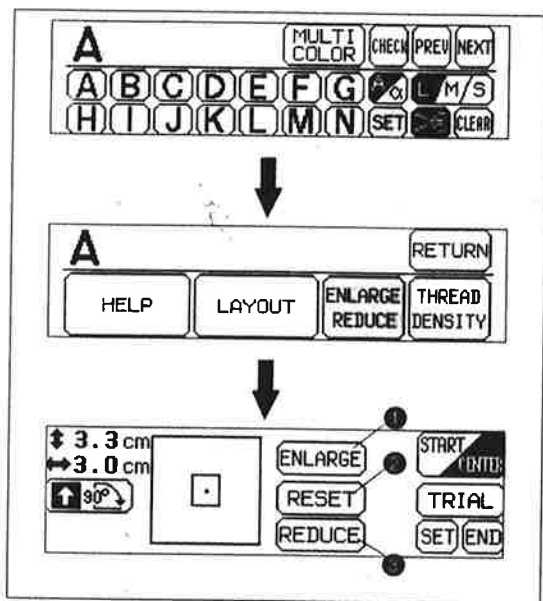

\* The sizes of characters and frame patterns can be changed as desired.

1. Touch "SET".
2. Touch "ENLARGE/REDUCE"
3. Touch "ENLARGE" to make the character or frame pattern larger, and touch "REDUCE" to make it smaller. If you touch "RESET", the pattern size will return to the original size.

- ① "ENLARGE" key
- ② "RESET" key
- ③ "REDUCE" key

\* Characters can be enlarged and reduced to sizes ranging from "L" to "S".  
 \* The enlargement sizes for frame patterns will vary according to the pattern.  
 \* Refer to page 43 for instructions on how to use other keys in this screen.

## Changing thread density of the stitch on characters and some frame patterns

SET

THREAD  
DENSITY

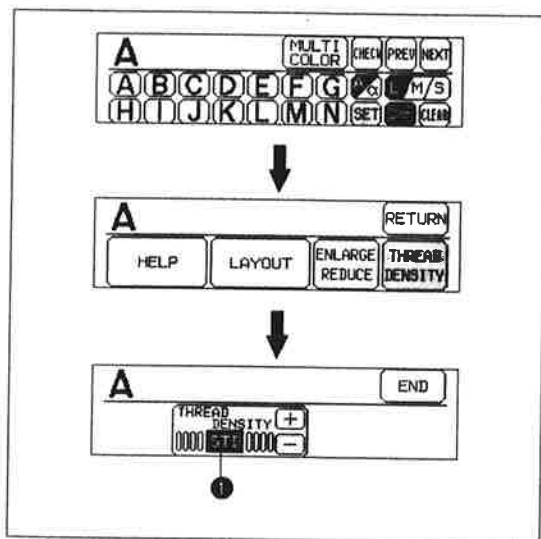

The thread density adjustment is not available for all patterns. Patterns other than the characters and some frame patterns are not adjustable.

1. Touch "SET".
2. Touch "THREAD DENSITY".
3. The thread density of the stitches will become farther apart (coarser) each time "-" key is touched. The thread density of the stitches will become closer together (finer) each time "+" key is touched.

- ① STD (standard)
- ② + (stitches closer together)
- ③ - (stitches farther apart)

\* The normal setting is "STD" (standard).

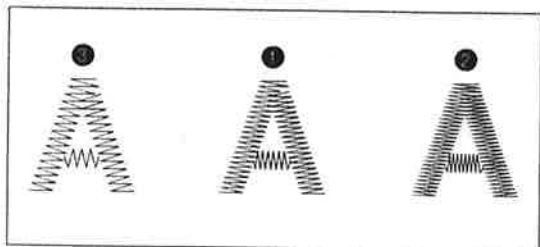



## SEWING A BASIC EMBROIDERY PATTERN

### Embroidering multi-color patterns

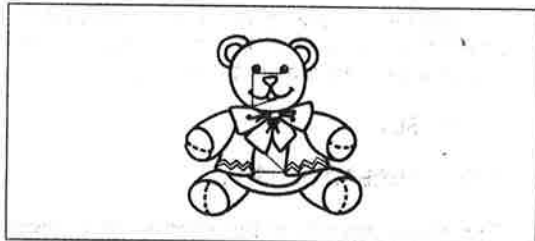
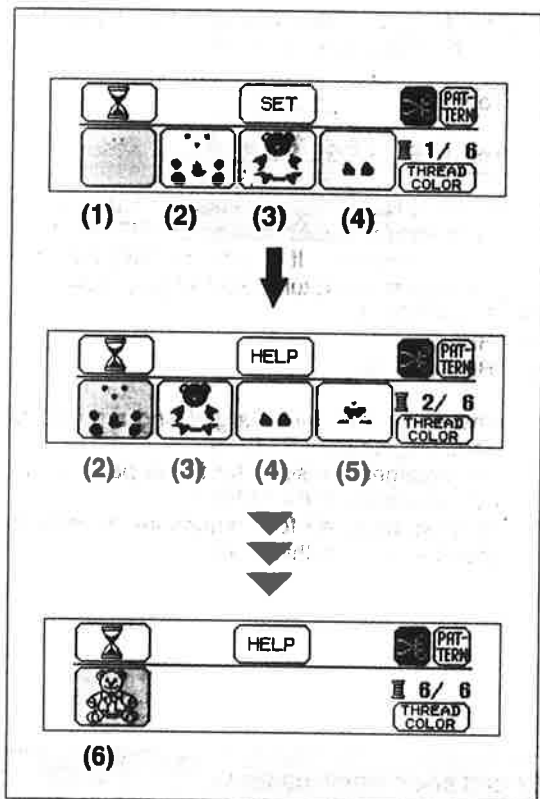

When a pattern is selected it is broken down into color diagrams on the screen. The order of embroidering is shown left to right. The diagram on the left is for the first thread color.

1. Thread the first color. (See page 16 – 17)  
When the "START/STOP" button is pressed, the first part of the pattern (1) will be sewn and then the machine will stop automatically.
  - \* Be sure to raise the presser foot before changing the thread.
  - \* When embroidering is completed for this color, the screen display will automatically move to the left one position.
2. Replace the upper thread with the next color and press the "START/STOP" button. The second part of the pattern (2) will be embroidered and the machine will then stop automatically.
3. Embroider the pattern to the last color in the same way.

4. Trim any excess thread.

### Embroidering single color patterns

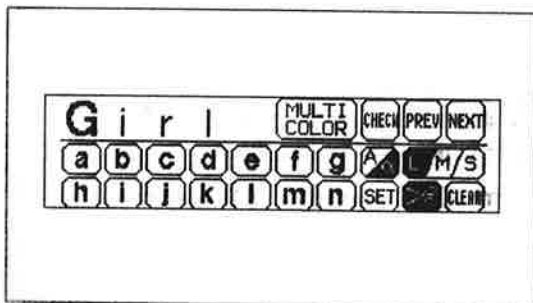

1. Thread the machine. (See page 16 – 17)
2. Install the embroidery frame. (See page 20 – 22)
3. Lower the presser foot.
4. Press the "START/STOP" button to sew the pattern: the machine will stop automatically when it is finished.
5. Raise the presser foot.
6. Trim any excess thread.

## Embroidering a single color pattern when "MULTI COLOR" is displayed

MULTI  
COLOR

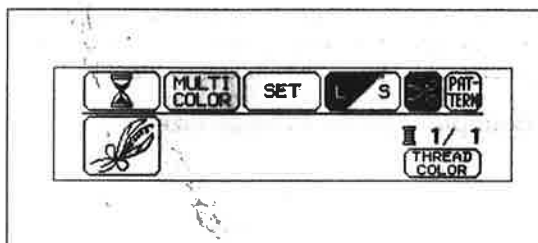

1. Touch "MULTI COLOR" to change to the single color mode. If the "START/STOP" button is pressed, a single color of the pattern will be embroidered and then the machine will stop automatically.
  - It is not possible to change between multi color mode and single color mode if "MULTI COLOR" is not displayed on the screen.

2. Trim any excess thread.

## Embroidering characters that extend beyond than one frame

LAYOUT

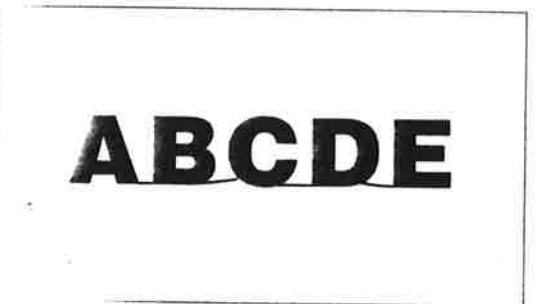
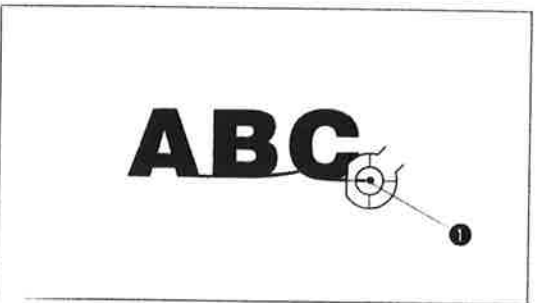
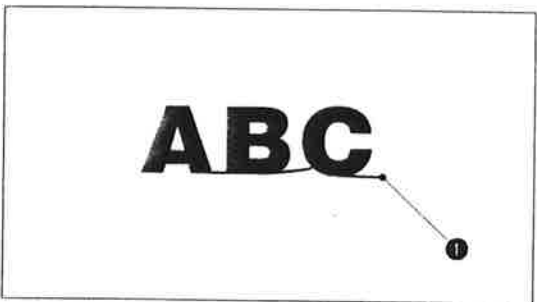
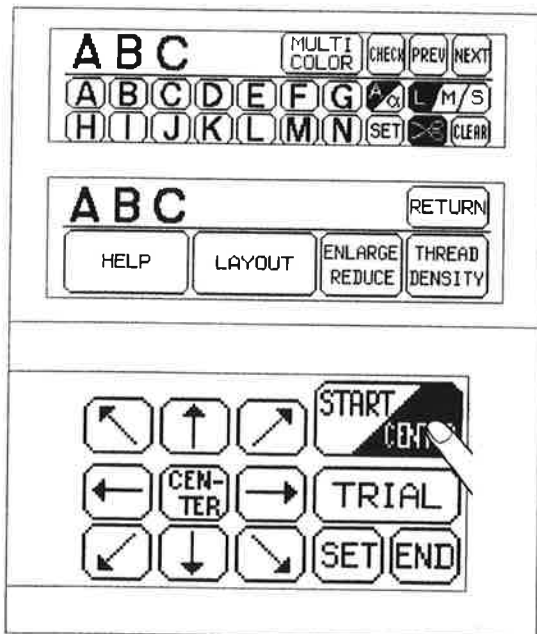

- \* This function is useful when there are many characters to embroider and you cannot embroider them all in the same frame.

### Example: ABCDE in large size

1. Input "ABC", then touch "SET" and then "LAYOUT". After this, touch "START/CENTER" to switch to "START".

2. Press the "START/STOP" button to start embroidering. When embroidering has finished, the machine will sew the finishing position automatically.

You can use the finishing position as the starting position for the characters to be embroidered next when the fabric is re-framed with the finishing point and last character just inside the left edge of the frame.

- ① Finishing position

3. Input the remaining letters "DE", and then touch "START/CENTER" to select "START".
4. Touch the arrow keys to move the start point of the needle to the finishing position of the last character and then press the "START/STOP" button to start the machine.

- ① Finishing position (Use it for the starting position of "DE".)

### Finished pattern

# EMBROIDERING APPLICATIONS

## Combining a frame pattern with a design

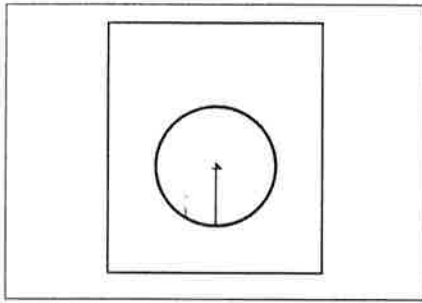

1. Select a frame pattern and embroider it.  
A "+" mark is sewn after embroidering of the frame pattern in the center of pattern. This mark can be used as a guide when embroidering characters or patterns to position them within the frame pattern.

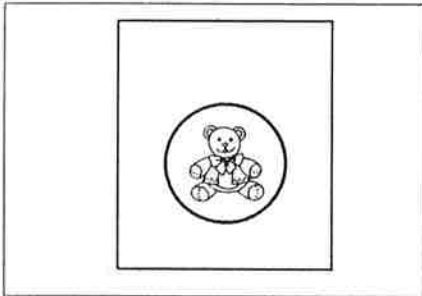

2. Using the "+" mark inside the frame pattern as a guide, align the needle using the center needle layout function. Embroider the design.

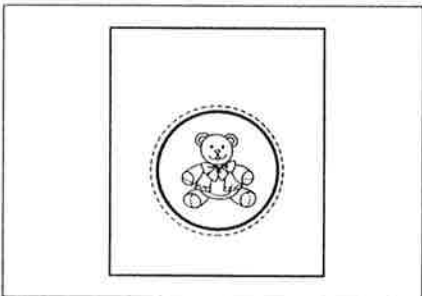

### Making badges or decorative patches

1. After embroidering a frame pattern and the combined design, sew an extra frame pattern on the outside using the "—" stitch slightly larger than the original frame pattern.

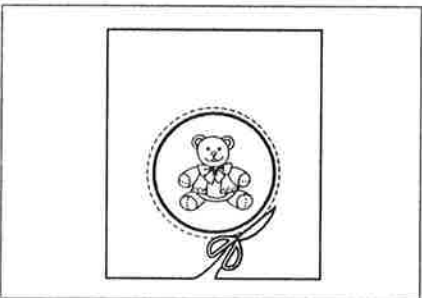

2. Cut cleanly around the frame pattern, following the line of the outside pattern.

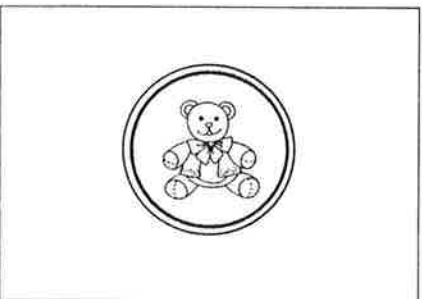

The finished badge or decorative patch is now ready to be attached to a project.

## Embroidering appliques (using a frame pattern)

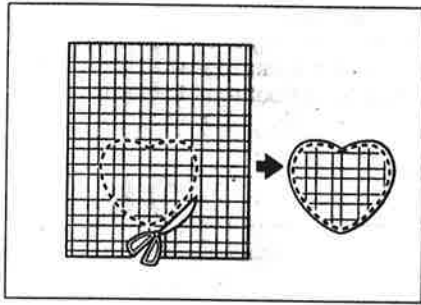

1. Select the applique fabric for the project, attach a stabilizer material, place in the embroidery frame and on the machine.
2. Select the frame shape to be embroidered and the " - - - " stitch: Embroider it onto the applique fabric. Remove the fabric from the frame. Cut neatly around the outside of the shape made by the stitches.

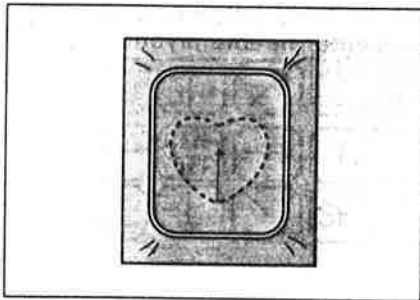

3. Attach a stabilizer material onto the back of the fabric on the project where the applique is to be placed. Center the area where the applique is to be placed in the embroidery hoop. Embroider it in the same way using the same frame pattern shape and " - - - " stitch as in step 2.

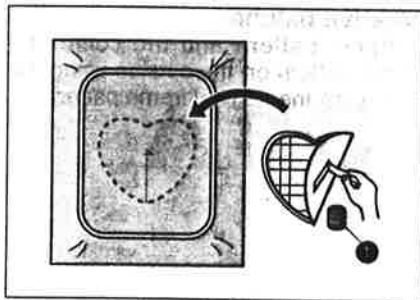

4. Apply a thin layer of fabric adhesive to the rear of the applique which is created in step 2, and then attach it to the base fabric so that it follows the frame shape just stitched.

● Adhesive

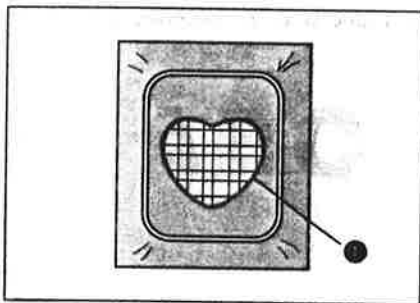

5. Without changing the frame shape or size, select the " — " stitch, and use it to embroider the applique material onto the project.

● Satin stitch " — "

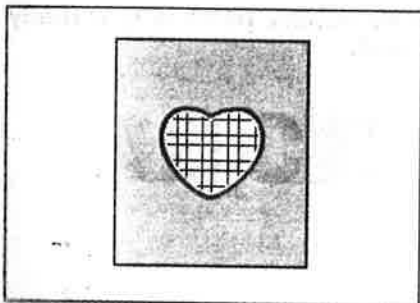

**The finished applique on the project**

## Embroidering onto small pieces of fabric or onto corners

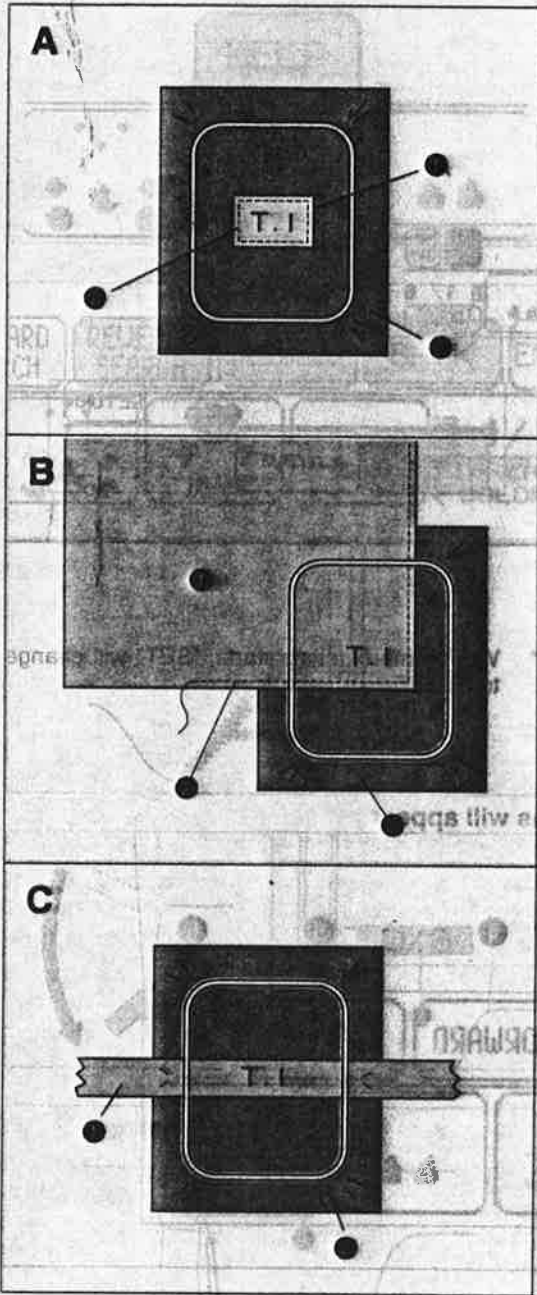

Use stabilizer material to provide extra support while embroidering. After embroidering is completed, remove the stabilizer material carefully.

### Case A

- Fabric
- Secure with double faced tape or a basting stitch
- Stabilizer

### Case B

- Fabric
- Secure with double faced tape or a basting stitch
- Stabilizer

### Case C

- Ribbon (Secure with double faced tape)
- Stabilizer

Touch this key to move back stitch by stitch without embroidering. If touched continuously, the stitch will be moved back in 8-stitch jumps starting from the (th) single stitch.

Touch this key to return to the previous screen and how many keys to touch.

Touch "HELP" then the following screen options will appear:

3. Lower the presser foot level and press the "START/STOP" button to start embroidering.

Touch "HELP" then the following screen options will appear:

Touch this key to move back to the start of the current color or character without embroidering.

Touch this key to move forward stitch by stitch without embroidering. If touched continuously, the stitch will be advanced in 8-stitch jumps starting from the (th) single stitch.

# IF THREAD BREAKS DURING EMBROIDERING OR WHEN PARTLY COMPLETING A PATTERN

12345

## Before embroidering

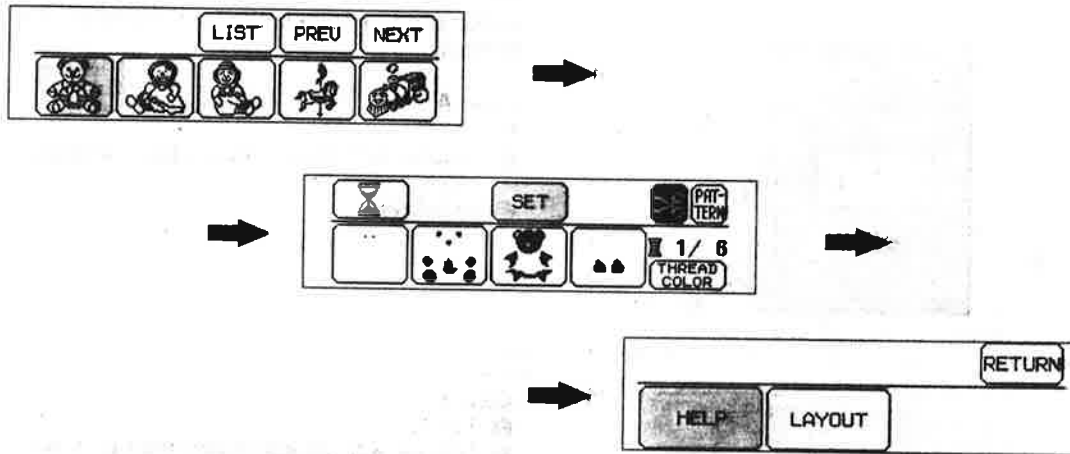

## While embroidering



\* When embroidering starts, "SET" will change to "HELP".

Touch "HELP", then the following screen options will appear

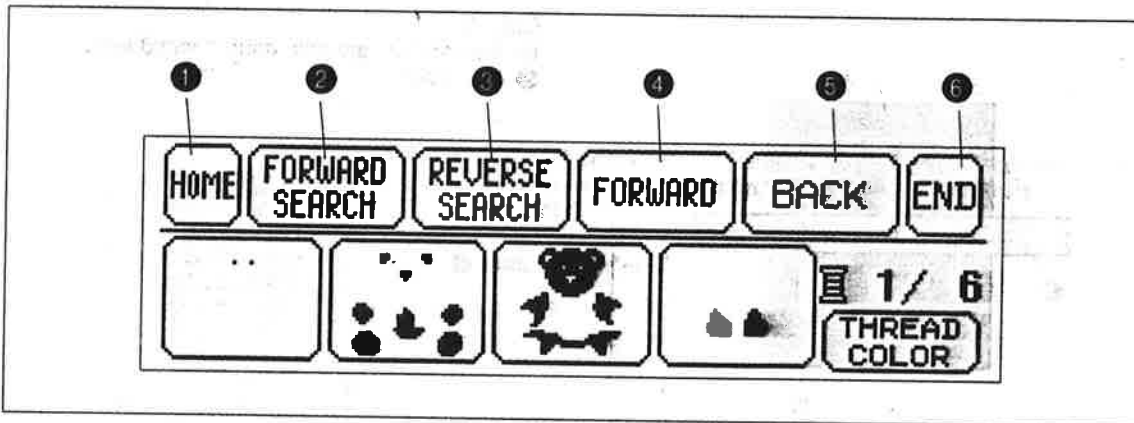

- ① Touch this key to move back to the start position for a pattern.
- ② Touch this key to move ahead to the start of the next color or character without embroidering.
- ③ Touch this key to move back to the start of the current color or character without embroidering.
- ④ Touch this key to move forward stitch by stitch without embroidering.  
(If touched continuously, the stitch will be advanced in 9-stitch jumps starting from the 6th single stitch)
- ⑤ Touch this key to move back stitch by stitch without embroidering.  
(If touched continuously, the stitch will be moved back in 9-stitch jumps starting from the 6th single stitch)
- ⑥ Touch this key to return to the previous screen and allow embroidery to begin.



## If thread breaks during embroidering

FORWARD SEARCH REVERSE SEARCH FORWARD BACK

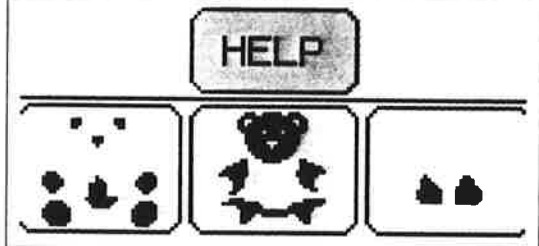
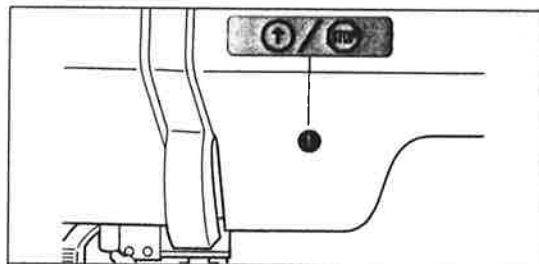
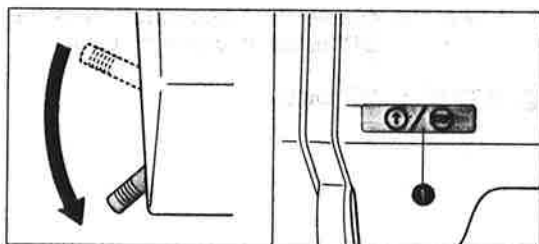
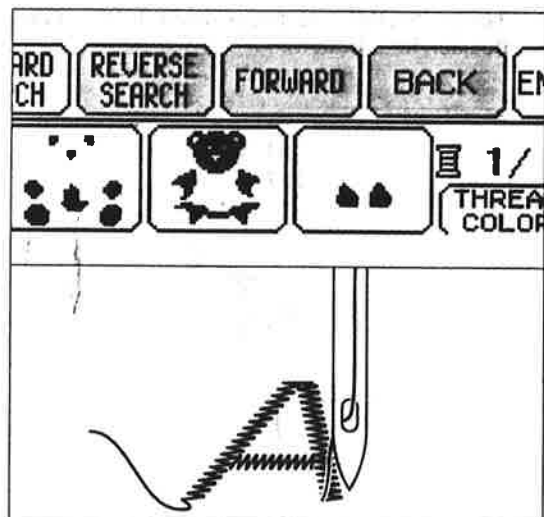
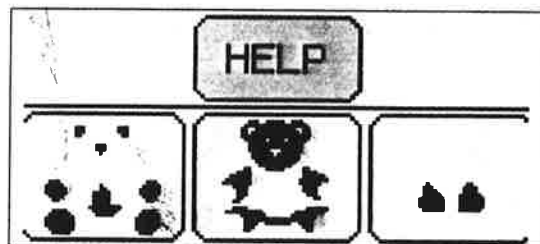

The machine stops automatically when the upper thread breaks. When this happens do the following.

1. If the upper thread breaks.
  - \* Re-thread the upper thread.
 If the lower thread breaks or the bobbin runs out of the thread:
  - \* Cut the upper thread above the fabric in the frame and then remove the embroidery frame. Replace the lower (bobbin) thread and then re-attach the embroidery frame.
2. Touch "BACK" to move back a few stitches to slightly before the position where the thread broke or the bobbin ran out of the thread.
  - \* If it is not possible to move back to the position where the thread broke, touch "REVERSE SEARCH" to move back to the beginning of that color, and then touch "FORWARD" to move forward to just before the position where the thread broke or the bobbin ran out of the thread.

3. Lower the presser foot lever and press the "START/STOP" button to restart embroidering.
  - \* If the machine stopped because the upper thread ran out, the upper thread may be tangled on the reverse side of the fabric (thread nesting). Remove the embroidery frame to check for this and trim off any excess build up.

① "START/STOP" button

If you stop the machine by pressing the "START/STOP" button and need to adjust the stitch location.

Touch "HELP".

Follow the same procedure as for "The machine stops automatically when the thread breaks."

① "START/STOP" button



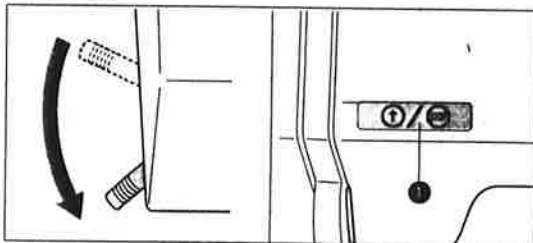
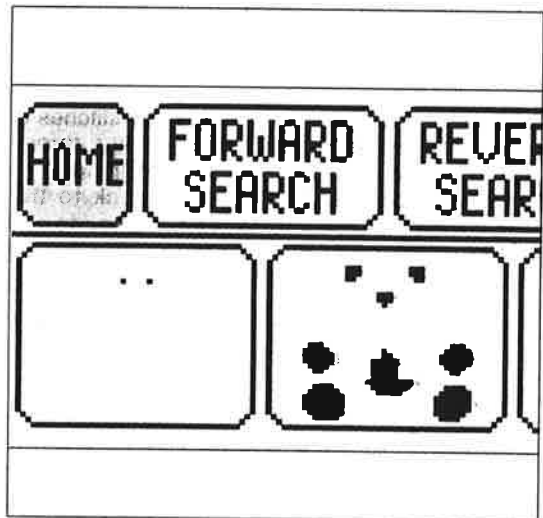

1. Touch "HOME" to move back to the start position for a pattern.

2. Lower the presser foot lever and press the "START/STOP" button to start embroidering.

① "START/STOP" button

# MAINTENANCE

## CHANGING THE LIGHT BULB

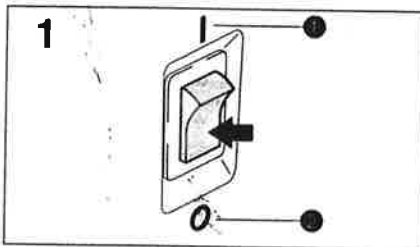

### When replacing the light bulb

1. Turn the main power switch off.

- ON
- OFF

\* The power cord plug must be removed from the socket outlet prior to changing the bulb.

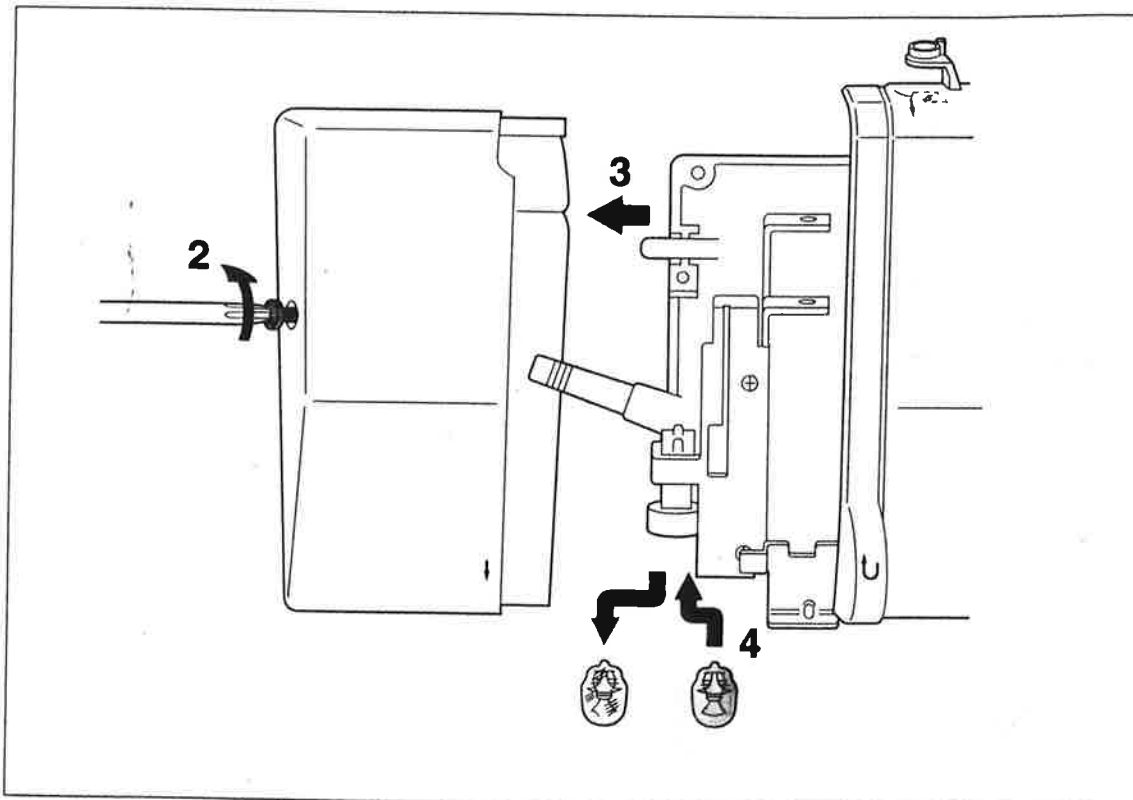

2. Loosen the screw in the end cap at the left side of the machine.

3. Remove the end cap.

4. Replace the snap-in light bulb with a new one of the same type.

\* Light bulbs are available through your dealer. (8 V, 2.4 W/ Parts code X50228-001.)

## CLEANING

### **Always keep the machine clean.**

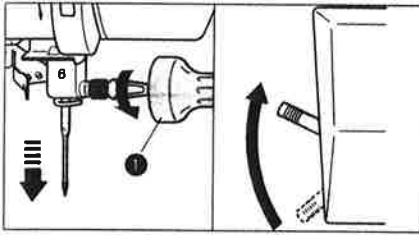

1. Turn off the power, remove the needle, and then raise the presser foot lever.

- 1 Use a screwdriver to loosen the screw to remove.

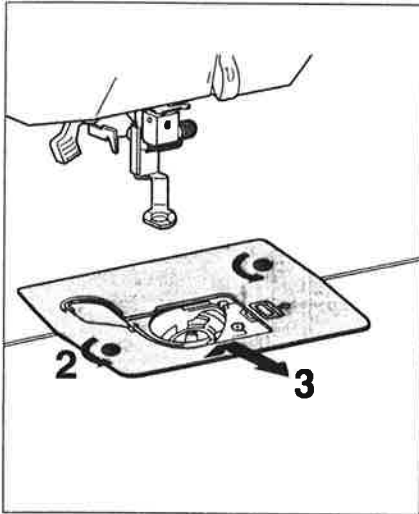

2. Loosen the screws on the needle plate.
3. Remove the needle plate.

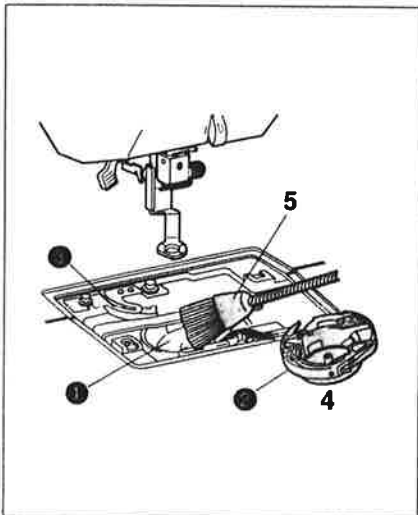

4. Take out the inner rotary hook.
5. Remove any accumulated lint and threads from the inner hook and race and from around the thread cutting knife with a brush or a small vacuum cleaner attachment.

- 1 Race
- 2 Inner rotary hook
- 3 Thread cutting knife

- \* Lint and dust accumulated in the race can cause poor quality stitching. In addition, if threads have accumulated around the thread cutting knife, it may prevent proper cutting of the thread.

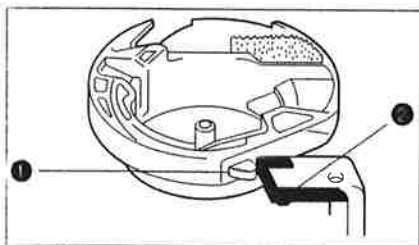

6. Put the inner rotary hook back in position by placing the projection of the hook next to spring of the stopper.

- 1 Projection of the hook
- 2 Spring of the stopper

# ERROR MESSAGE

When the machine is not properly set and the "START/STOP" button is pressed, or a correction in your operation is required, machine will not start and will instruct you with an alarm and error number on the LCD.

## Warning message displays

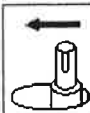

Return bobbin winding shaft to left.

This message is displayed when the bobbin winding shaft is at the right side and the "START/STOP" button is pressed. This message may be displayed after the display warns you to raise the needle to the highest position.

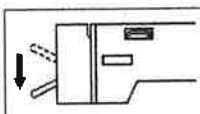

Lower presser foot lever.

This message is displayed when the "START/STOP" button is pressed while the presser foot lever is raised.

Select pattern.

This message is displayed when a pattern has not been selected and the "START/STOP" button is pressed or "LAYOUT" is touched.

Check if upper or lower thread is cut.

This message is displayed when the machine senses that the upper or lower thread has broken or no upper thread is threaded or the bobbin runs out of the thread.

Check if thread is entangled.  
Check if needle is bent.

This message is displayed if the motor locks. This could be caused by a tangled thread or embroidering with a bent needle.

No pattern is memorized.

This message is displayed when "RETRIEVE" is touched and there is no pattern stored in that memory space.

This pattern is stored in other embroidery card.

This message is displayed when the RETRIEVE key is touched and the design in the machine's memory is from a different memory card than is currently inserted.

Memory card patterns cannot be saved into the machine's memory. However, the characters from memory card #1, the Alphabet card and #10, Monogram emblem card, can be saved and retrieved while the card is inserted. The card that the design was saved from must be inserted in order to retrieve the design.

This pattern can not be saved in the memory.

This message is displayed when you are trying to save patterns that cannot be combined.

Embroidery card is not inserted. Turn off main power and insert card.

This message is displayed if "CARD" is touched while no memory card is inserted.

Raise the presser foot and re-thread.

This message is displayed when the "START/STOP" button is pressed but the presser foot has not been raised to change the thread color.

If you are not changing the thread color, raise the presser foot lever, lower it again, and then press the "START/STOP" button to start the machine.

This key does not work when needle is at low position. Raise the needle to high position and touch key again.

This message is displayed if an attempt is made to move the embroidery frame while the needle is in the down position. Use the balance wheel to move the needle to the highest position. Then continue.

Embroidery pattern is exceeding sewing area.

This message is displayed if the combined size of patterns exceeds the size of the embroidering area.

Raise the needle to high position.

This message is displayed if the needle is in the down position when the power is turned on.

Color cannot be changed halfway.

This message is displayed if "MULTI COLOR" is pressed when pattern embroidering has already began.

Complete pattern entry.

This message is displayed if the "START/STOP" button is pressed when pattern input for a "frame pattern" has not yet been completed.

No more stitches can be combined.

This message is displayed when the total number of characters or patterns combined exceeds a maximum 35.

 Bobbin thread is running out.

This message is displayed when the amount of bobbin thread remaining becomes low during embroidering.

Calculating cannot be done half-way through.

This message is displayed if you touch the "" key while the machine is embroidering.

### Instruction message displays

 Winding bobbin thread.

This message is displayed during bobbin winding.

Saving

This message is displayed after a "MEMORY" space is touched to save a pattern to that space. The power should not be turned off while this is on the display.

Calculating.  
Please wait.

This message is displayed while the machine is calculating after you touched the "" key. Touch "CANCEL" if you would like to interrupt the calculation process.

Cut the thread?

This message is displayed when the "THREAD CUTTER" key is pressed. Touch "OK" to have the thread cut.

### Audio alarms

- Proper operation will sound: One beep  
Improper (wrong) operation will sound: Two or four beeps

# TROUBLESHOOTING

**Check for the cause of the problem without worrying.**

Whenever embroidering becomes difficult, review the section of the instruction book which explains the operation you are performing to make sure that you are using the machine correctly. If you still have difficulty, the following check list may help you correct it. If you still experience difficulties, contact your dealer or nearest authorized service center.

## Trouble with thread and stitches

Symptom	Probable cause	Remedy
<b>1. Upper thread breaks</b>	1. The upper threading is not correct.	1. Re-thread the upper thread.
	2. The upper thread is tangled.	2. Clean the race or inner rotary hook.
	3. The spool of thread is not correctly set.	3. Set the spool of thread correctly.
	4. The correct needle is not used.	4. Change to the proper needle.
	5. A thread other than the designated upper embroidery thread is being used.	5. Replace with the designated upper embroidery thread.
<b>2. Lower thread breaks</b>	1. The upper thread is tangled.	1. Clean the race or inner rotary hook.
	2. The bobbin is not threaded properly in the shuttle.	2. Remove the bobbin, reset the bobbin properly and pull the bobbin thread through the channel.
	3. A thread other than the designated lower embroidery thread is being used.	3. Replace with the designated lower embroidery thread.
<b>3. Skipped stitches</b>	1. The needle is not correctly inserted.	1. Set the needle properly.
	2. The correct needle is not used.	2. Change to the proper needle.
	3. The fabric has been placed in the embroidery frame incorrectly.	3. Place the fabric in the embroidery frame correctly.
	4. The embroidery frame has been attached to the machine incorrectly.	4. Attach the embroidery frame to the machine correctly.
	5. Thin or stretch fabric is being used with no stabilizer fabric attached.	5. Attach stabilizer fabric.
<b>4. Fabric puckers</b>	1. The upper thread tension is too strong.	1. Decrease the upper thread tension using the upper thread tension dial.
	2. The upper or lower thread is not threaded correctly.	2. Thread the upper and lower threads correctly.
	3. Thin or stretch fabric is being used with no stabilizer fabric attached.	3. Attach stabilizer fabric.
	4. The fabric has been placed in the embroidery frame incorrectly.	4. Place the fabric in the embroidery frame correctly.
	5. The correct needle is not being used.	5. Change to the proper needle.

Symptom	Probable cause	Remedy
5. Lower thread is visible on the top surface of the fabric	1. The upper thread tension is too strong.	1. Decrease the upper thread tension using the upper thread tension dial.
	2. The upper or lower thread is not threaded correctly.	2. Thread the upper and lower threads correctly.
	3. The thread has been threaded incorrectly through the inner rotary hook.	3. Remove the bobbin, reset the bobbin properly and pull the bobbin thread through the channel.
	4. A thread other than the designated lower embroidery thread is being used.	4. Replace with the designated lower embroidery thread.
6. Upper thread is loose	1. The upper thread tension is too weak.	1. Increase the upper thread tension using the upper thread tension dial.
	2. The upper or lower thread is not threaded correctly.	2. Thread the upper and lower threads correctly.
	3. Threads other than the designated upper and lower embroidery thread are being used.	3. Replace with the designated upper and lower embroidery threads.
7. Embroidered pattern is out of shape	1. The fabric has been placed in the embroidery frame incorrectly.	1. Place the fabric in the embroidery frame correctly.
	2. The embroidery frame has been attached to the machine incorrectly.	2. Attach the embroidery frame to the machine correctly.
	3. Thin or stretch fabric is being used with no stabilizer fabric attached.	3. Attach stabilizer fabric.
	4. Threads other than the designated upper and lower embroidery thread are being used.	4. Replace with the designated upper and lower embroidery threads.
	5. The thread is tangled.	5. Cut and remove the tangled threads inside the rotary hook using scissors. Clean the race or inner rotary hook.
8. Threading is not possible	1. The needle is installed incorrectly.	1. Install the needle correctly.
	2. The needle threader lever will not turn.	2. Turn the balance wheel to raise the needle to its highest position.
9. Thread is not cut during automatic thread cutting.	1. Thread has accumulated around the thread cutting knife.	1. Remove the needle plate and clean away the accumulated thread.



## Mechanical problems

Symptom	Probable cause	Remedy
1. Machine operation is slow and noisy.	1. Thread scraps and dust have accumulated under the needle plate.	1. Remove the thread scraps and dust with a brush.
2. The machine does not start.	1. The "START/STOP" button is not pressed.	1. Press the "START/STOP" button.
	2. The main power switch is in the off position.	2. Turn the power on.
	3. The presser foot is not lowered.	3. Lower the presser foot.
	4. Check Error messages.	4. See "ERROR MESSAGE" on page 59.
3. The needle breaks.	1. The needle is not correctly inserted.	1. Remove the needle and reset a new needle properly.
	2. The correct needle is not used.	2. Change to the proper needle.

### Caution

- This machine is equipped with a thread breakage sensor. Accordingly, if the upper thread is not threaded, the machine will not operate even if the "START/STOP" button is pressed. In addition, a loud noise which is different from the normal operation noise is generated by the needle bar holding mechanism during layout changes, layout change tests and also when the embroidery frame travels a lot during embroidery. This sound is normal and is not the result of a malfunction.
- If the power goes off during embroidering:
  - Turn the power off and unplug the machine. Damage may occur if the machine is on when the power comes back on.
  - To start again, while the main power switch is off, plug the unit in. Then turn the main power switch on and select an operation. Refer to page 54, using the "HELP" function to get back to the point where the machine went off.

# PATTERNS

## Character embroidering chart

Sizes: [L] 30 mm (1-3/16"), [M] 15 mm (9/16") [S] 7.5 mm (1/4")

ABCDEFGHIJKLMNOPQRSTUVWXYZ  
abcdefghijklmnopqrstuvwxyz  
ÄÅÂÆÑÖØÇÜßääåâæëèéêñöòøïçüù  
0123456789 &?!.-\_( )', /

Sizes: [L] 15 mm (0-9/16"), [S] 12 mm (0-1/2")

ABCDEFGHIJKLMNOPQRSTUVWXYZ  
PQRSTUVWXYZ.

## Frame pattern embroidering chart

<Sizes can be enlarged or reduced.>

### Frames

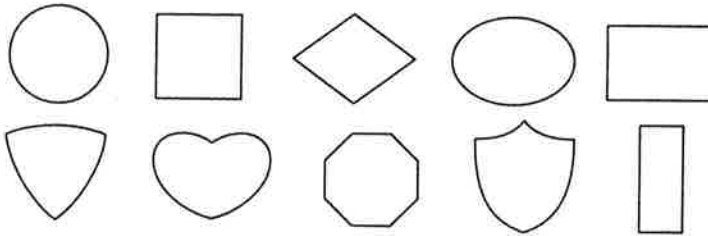

### Stitches

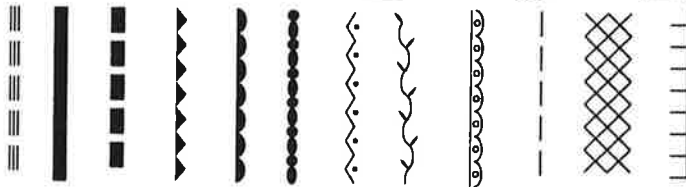

# One point mark embroidery pattern

<Embroidering times: 3 - 44 min. (It does not include the time needed to change colors.)>



- 1--WHITE
- 2--SALMON PINK
- 3--LIGHT BROWN
- 4--BLUE
- 5--RED
- 6--BLACK



- 1--WHITE
- 2--VERMILION
- 3--LINEN
- 4--BLUE
- 5--LIGHT BLUE
- 6--BLUE
- 7--BLACK
- 8--VERMILION



- 1--BLUE
- 2--WHITE
- 3--LIGHT BLUE
- 4--VERMILION
- 5--LINEN
- 6--BLUE
- 7--WHITE
- 8--BLACK
- 9--WHITE
- 10--VERMILION



- 1--YELLOW
- 2--SILVER
- 3--BLUE
- 4--MAGENTA
- 5--RED
- 6--YELLOW
- 7--WHITE
- 8--BLACK
- 9--BLUE



- 1--WHITE
- 2--EMERALD GREEN
- 3--MAGENTA
- 4--BLACK
- 5--RED
- 6--MAGENTA
- 7--YELLOW
- 8--TANGERINE
- 9--BLACK



- 1--WHITE
- 2--YELLOW
- 3--VERMILION
- 4--BLUE
- 5--LIGHT BLUE
- 6--BLUE
- 7--PURPLE



- 1--VERMILION
- 2--SILVER
- 3--WHITE
- 4--BLUE
- 5--RED
- 6--SILVER
- 7--BLACK



- 1--YELLOW
- 2--LIGHT LILAC
- 3--WHITE
- 4--DEEP GOLD
- 5--CORN FLOWER BLUE
- 6--TEAL GREEN



- 1--ORANGE
- 2--LIGHT BLUE
- 3--YELLOW
- 4--PEWTER
- 5--LIME GREEN
- 6--BLACK

Order of sewing

Embroidery thread color



- 1--YELLOW
- 2--TANGERINE
- 3--VERMILION
- 4--BEIGE
- 5--LIGHT BROWN
- 6--MOSS GREEN



- 1--BLUE
- 2--WHITE
- 3--YELLOW
- 4--ORANGE
- 5--TANGERINE
- 6--VERMILION
- 7--TEAL GREEN
- 8--BLACK



- 1--LIGHT BLUE
- 2--SALMON PINK
- 3--VERMILION
- 4--WHITE
- 5--BLUE
- 6--VERMILION



- 1--RED
- 2--LIME GREEN
- 3--EMERALD GREEN
- 4--LIME GREEN



- 1--YELLOW
- 2--LIME GREEN
- 3--LIGHT LILAC
- 4--SALMON PINK
- 5--WHITE
- 6--CLAY BROWN
- 7--LIGHT LILAC
- 8--DARK GRAY



- 1--YELLOW
- 2--BLUE
- 3--LIGHT BLUE
- 4--EMERALD GREEN
- 5--SALMON PINK
- 6--RED
- 7--YELLOW



- 1--EMERALD GREEN
- 2--YELLOW
- 3--RED
- 4--BLACK
- 5--YELLOW



- 1--BLUE
- 2--SILVER
- 3--WHITE
- 4--BEIGE
- 5--SKY BLUE
- 6--LIGHT BLUE
- 7--BLACK



- 1--FRESH GREEN
- 2--LILAC
- 3--BEIGE
- 4--SILVER
- 5--BLACK
- 6--CORN FLOWER BLUE
- 7--YELLOW



- 1--LIGHT BLUE
- 2--MINT GREEN
- 3--LIGHT LILAC
- 4--WHITE
- 5--SALMON PINK
- 6--YELLOW



- 1--MINT GREEN
- 2--LIGHT BLUE
- 3--LIGHT LILAC
- 4--YELLOW
- 5--LIGHT LILAC
- 6--LIGHT BLUE
- 7--WHITE



- 1--LIGHT BROWN
- 2--RED
- 3--TEAL GREEN
- 4--YELLOW
- 5--CORN FLOWER BLUE
- 6--DARK GRAY



- 1--SALMON PINK



- 1--WHITE
- 2--LIGHT BLUE
- 3--BLUE



- 1--YELLOW
- 2--MOSS GREEN
- 3--WHITE



- 1--SKY BLUE
- 2--ORANGE
- 3--BLUE
- 4--LIME GREEN
- 5--MOSS GREEN



- 1--EMERALD GREEN
- 2--DARK BROWN
- 3--TANGERINE
- 4--RED
- 5--DEEP ROSE



- 1--YELLOW
- 2--MOSS GREEN
- 3--CORN FLOWER BLUE
- 4--LIME GREEN
- 5--EMERALD GREEN
- 6--SALMON PINK
- 7--VERMILION
- 8--BLACK



- 1--LIME GREEN
- 2--EMERALD GREEN
- 3--BLACK
- 4--SALMON PINK
- 5--VERMILION



- 1--GREEN
- 2--LIME GREEN
- 3--EMERALD GREEN
- 4--WHITE
- 5--FRESH GREEN
- 6--SALMON PINK
- 7--ORANGE
- 8--PEWTER



- 1--LINEN
- 2--WHITE
- 3--MINT GREEN



- 1--CORN FLOWER BLUE
- 2--MINT GREEN
- 3--YELLOW
- 4--TEAL GREEN
- 5--LIGHT BROWN
- 6--WHITE
- 7--RED
- 8--BLACK
- 9--LIGHT BROWN



- 1--WHITE
- 2--LIGHT BROWN
- 3--DARK BROWN
- 4--BLACK
- 5--EMERALD GREEN
- 6--BLUE



- 1--WHITE
- 2--LINEN
- 3--BEIGE
- 4--RED
- 5--BLACK
- 6--LIME GREEN
- 7--EMERALD GREEN
- 8--PEWTER



- 1--PINK
- 2--WHITE
- 3--EMERALD GREEN
- 4--BLACK
- 5--EMERALD GREEN
- 6--BLACK
- 7--YELLOW



- 1--CLAY BROWN
- 2--WHITE
- 3--RED
- 4--VERMILION
- 5--EMERALD GREEN
- 6--SILVER
- 7--BLACK
- 8--EMERALD GREEN



- 1--WHITE
- 2--LIGHT BLUE
- 3--SALMON PINK
- 4--LIGHT BLUE
- 5--MINT GREEN
- 6--CORN FLOWER BLUE
- 7--TEAL GREEN
- 8--BLACK
- 9--MINT GREEN



- 1--WHITE
- 2--RED
- 3--DEEP GOLD
- 4--CLAY BROWN
- 5--DARK BROWN



- 1--BEIGE
- 2--LIME GREEN
- 3--EMERALD GREEN
- 4--MOSS GREEN
- 5--TEAL GREEN
- 6--RED
- 7--SILVER
- 8--BLACK



- 1--LIGHT BROWN
- 2--BLUE
- 3--LINEN
- 4--RED
- 5--DARK BROWN
- 6--DARK GRAY
- 7--MINT GREEN
- 8--EMERALD GREEN
- 9--DARK GRAY
- 10--BLACK



- 1--RED
- 2--BLUE
- 3--DARK BROWN
- 4--SILVER
- 5--MINT GREEN
- 6--LINEN
- 7--EMERALD GREEN
- 8--BLACK
- 9--WHITE



- 1--WHITE
- 2--BLUE
- 3--TANGERINE
- 4--BLACK
- 5--RED
- 6--WHITE
- 7--BLUE



- 1--LIME GREEN
- 2--EMERALD GREEN
- 3--LIGHT BLUE
- 4--SKY BLUE
- 5--BLUE



- 1--ORANGE
- 2--YELLOW
- 3--CREAM BROWN
- 4--MOSS GREEN
- 5--LIME GREEN



- 1--LIME GREEN
- 2--EMERALD GREEN
- 3--YELLOW
- 4--WHITE
- 5--ORANGE



- 1--MAGENTA
- 2--LIGHT LILAC
- 3--LILAC
- 4--PEWTER
- 5--MAGENTA



- 1--LIME GREEN
- 2--LINEN
- 3--TANGERINE
- 4--DEEP GOLD
- 5--VERMILION
- 6--MOSS GREEN
- 7--TANGERINE
- 8--VERMILION



- 1--LIGHT BLUE
- 2--CORN FLOWER BLUE
- 3--YELLOW
- 4--WHITE
- 5--LIGHT BLUE
- 6--LIGHT LILAC
- 7--TEAL GREEN



- 1--FRESH GREEN
- 2--SALMON PINK
- 3--BEIGE
- 4--BLUE
- 5--BLACK
- 6--YELLOW



- 1--CREAM BROWN
- 2--YELLOW
- 3--LINEN
- 4--DEEP GOLD
- 5--BRASS



- 1--LIGHT BLUE
- 2--LIGHT LILAC



- 3--CORN FLOWER BLUE



- 4--ORANGE
- 5--MAGENTA

Patterns which are stored in the machine or memory cards are for home use only. These patterns are not to be used for any activity other than home use.

# EMBROIDERING USING A SMALL FRAME

EMBROIDER (OPT)

## Embroidering items such as handkerchiefs and collars

If the accessory frame fabric to be embroidered optional small frame.

- ① Embroidery sheet
- ② Embroidering range (Height: 70 mm (2-3/4") Width: 70 mm (2-3/4"))

### CAUTION

Take note of the following when using the small frame.

1. Always make sure that the initial setting operation for the carriage (embroidery arm) after the power is turned on — in other words, the movement of the carriage (embroidery arm) in order to set the position — is completed before installing the small embroidery frame.
2. If you do not change the position of the pattern on the "LAYOUT" screen, check that the embroidering area for the pattern selected is within 70 mm (2-3/4") in height and width by touching the "LAYOUT" key. If it is, the pattern can be embroidered correctly.
3. If you have changed the position of the pattern using the arrow keys in the "LAYOUT" screen, use the "TRIAL" function to check that the pattern does not extend past the edges of the frame before starting embroidering. Before touching "TRIAL", raise the needle and the presser foot lever to their highest positions.

### Embroidering handkerchiefs and cuffs

Set the handkerchief into the small frame. You can use the rotation function to move the needle to the desired embroidering location.

### Embroidering items which won't fit into the frame

For items which won't fit into the frame, baste or iron a piece of stabilizer fabric onto the part to be embroidered, and then place the entire piece into the frame together with the fabric to be embroidered.

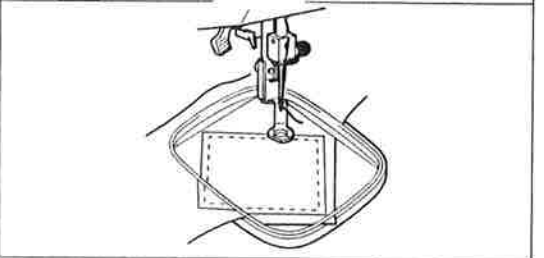
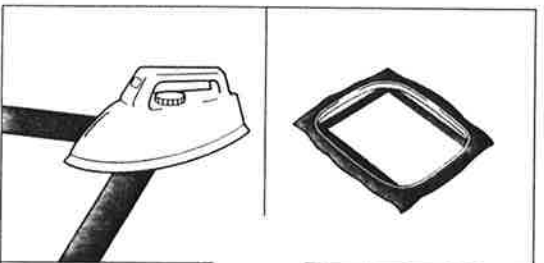
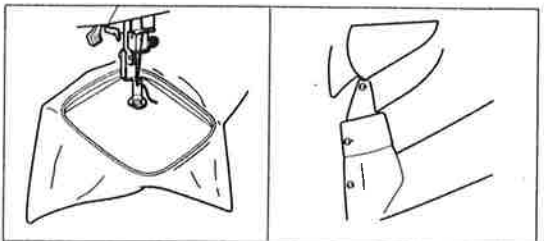
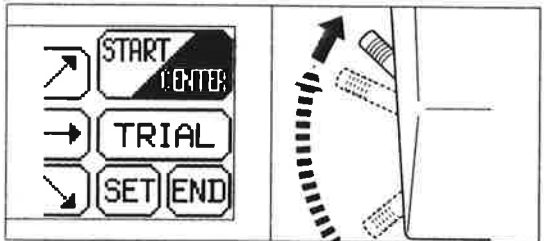
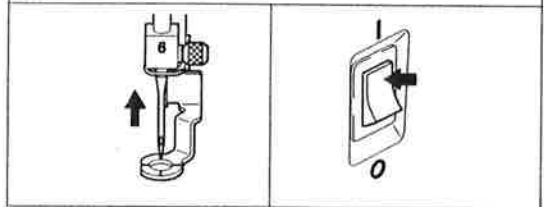
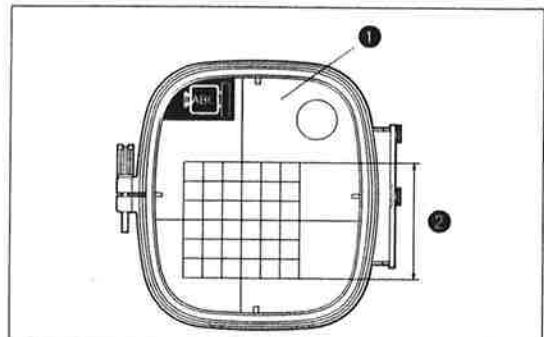

# EMBROIDERING USING A EXTRA-SMALL FRAME (OPTIONAL)

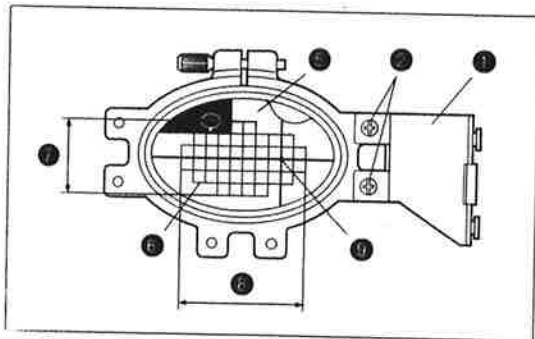
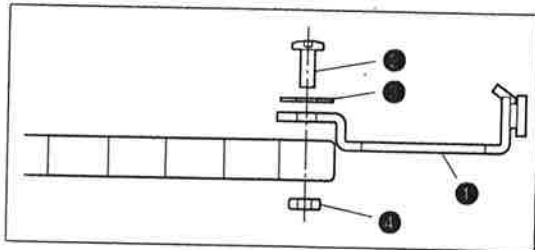
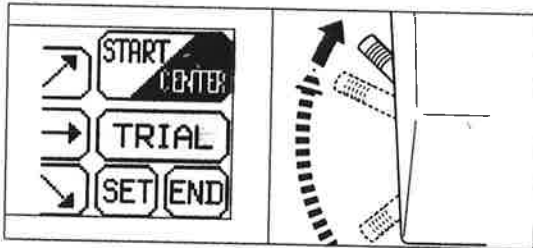
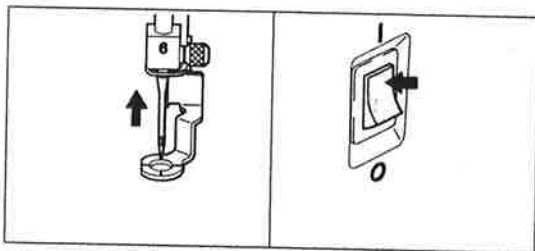
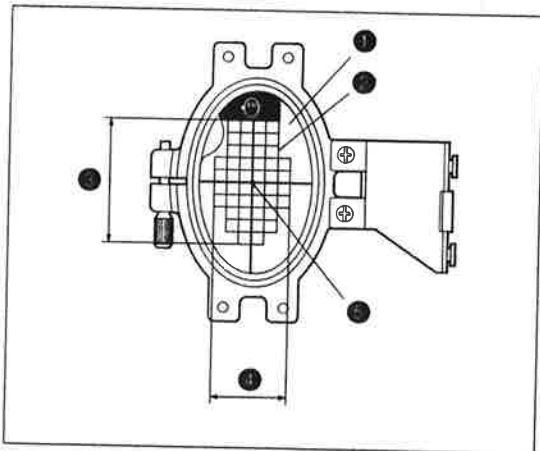

An extra-small frame which is smaller than the small frame mentioned on the previous page is also available as an option. It is used mostly for monogramming initials on pockets or cuffs. The extra-small frame can be used to embroider even smaller articles.

- ① Embroidery sheet (vertical type)
- ② Embroidery range
- ③ Maximum embroidering area  
– Height : 50 mm (1-15/16")
- ④ Maximum embroidering area  
– Width : 30 mm (1-3/16")
- ⑤ Center of pattern

## CAUTION

Take note of the following when using the extra-small frame.

1. Always make sure that the initial setting operation for the carriage (embroidery arm) after the power is turned on — in other words, the movement of the carriage (embroidery arm) in order to set the position — is completed before installing the extra-small embroidery frame.
2. Using the arrow keys in the "LAYOUT" screen, use the "TRIAL" function to check that the pattern does not extend past the edges of the frame before starting embroidering.
3. Before touching "TRIAL", raise the needle and the presser foot lever to their highest positions.

- \* The extra-small frame can also be used horizontally by changing the position of attachment to the frame fixing plate. Use a screwdriver to remove the two screws in order to change the attachment position.
- \* Use the horizontal attachment sheet when the frame is attached horizontally.

- ① Frame fixing plate
- ② Screws (x 2)
- ③ Washers (x 2)
- ④ Nuts (x 2)
- ⑤ Embroidery sheet (horizontal type)
- ⑥ Embroidery range
- ⑦ Maximum embroidering area  
– Height : 30 mm (1-15/16")
- ⑧ Maximum embroidering area  
– Width : 50 mm (1-3/16")
- ⑨ Center of pattern

# EMBROIDERING USING A LARGE FRAME (OPTIONAL)

## Embroidering range

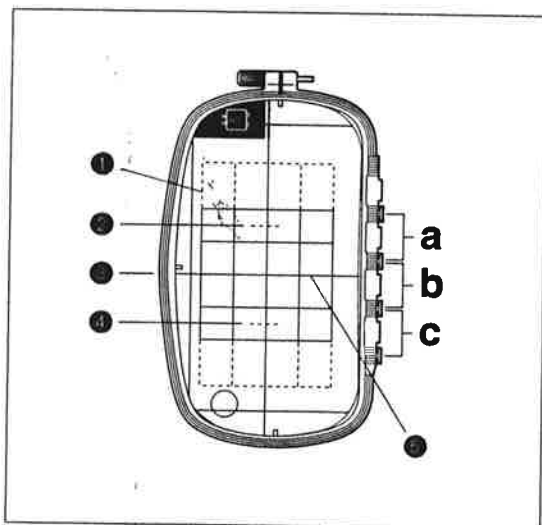

- 1 Embroidering range  
18.2 × 11 cm  
(7-3/16" × 4-5/16")
- 2 Center when frame is clamped in position "a".
- 3 Center when frame is clamped in position "b".
- 4 Center when frame is clamped in position "c".
- 5 Reference line

## Combining patterns in the height direction

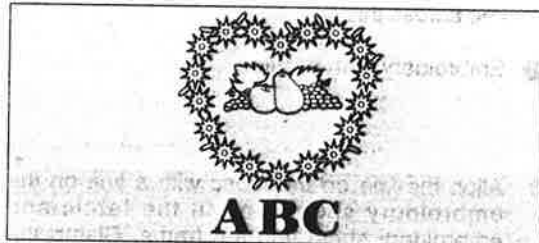

1. If the overall height is within 18.2 cm (7-3/16"), you can embroider the respective patterns simply by changing the clamping position of the frame.

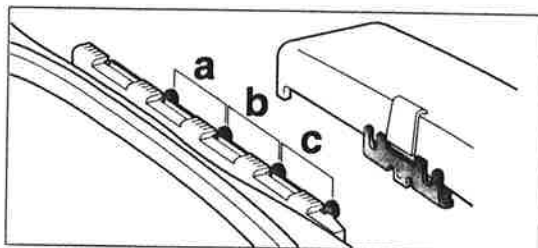

2. Once the pattern at the top has been embroidered, move the clamp from position "a" to position "b" or position "c".

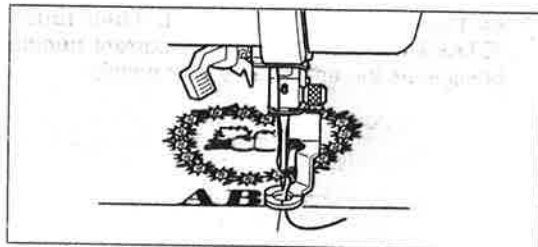

3. Embroider the pattern at the bottom.

## Linking two or more embroidered patterns (using the 90° rotation feature)

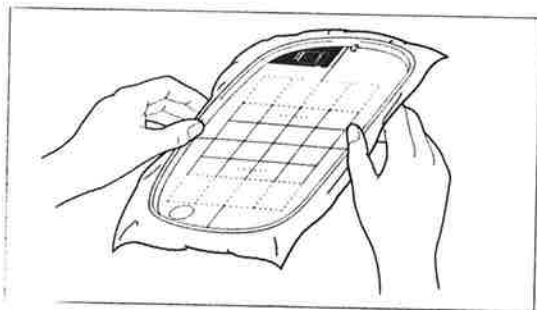
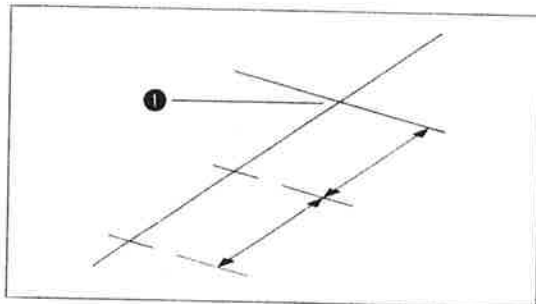
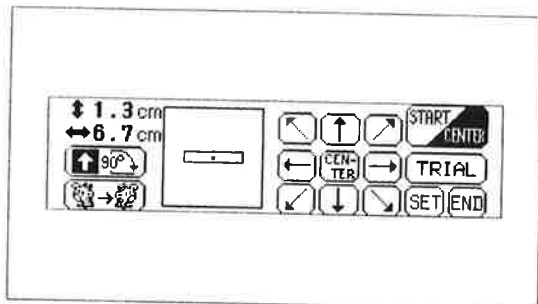
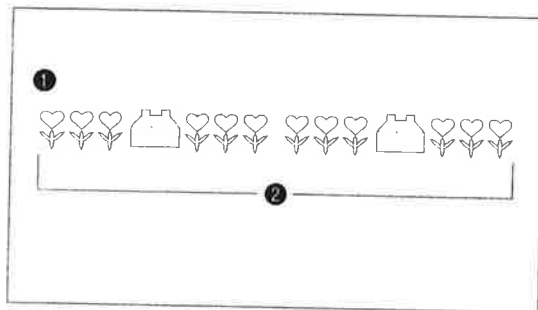

### Example: Patterns in Flower card (No. 2)

1. Check the lengths of the patterns you wish to embroider continuously by touching "LAYOUT". If the length is within 18.2 cm (7-3/16"), you can proceed with embroidering just by changing the embroidery location, without having to re-set the fabric in the frame.

- ① Finished appearance
- ② Within 18.2 cm (7-3/16")

After selecting the pattern, touch "LAYOUT" to check the size of the pattern.

The size of the pattern is displayed on the left side on the screen.

2. Draw a line on the fabric marking the place where the patterns will be embroidered. Find the center line, and then draw the line along the whole length of the pattern, marking it off into two even lengths. Mark the embroidery start position with a cross by drawing another line across this line.

- ① Embroidery start position

3. Align the line on the fabric with a line on the embroidery sheet, and fit the fabric and embroidery sheet into the frame. Clamp the frame with the carriage at the place indicated by "a". (see next page)

4. After touching "LAYOUT", touch "90° clockwise" to change the arrow in the display so that it points to the right. Then touch "START/CENTER" to set the current needle position as the embroidery start position.

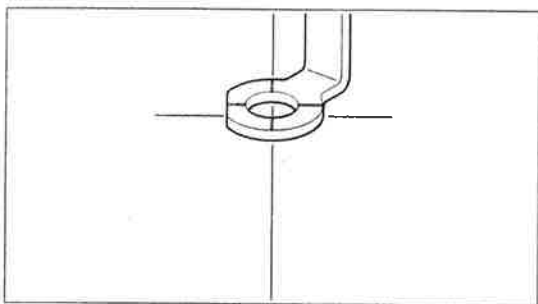

5. Use the arrow keys to move the needle to the embroidery start position, and then start embroidering.

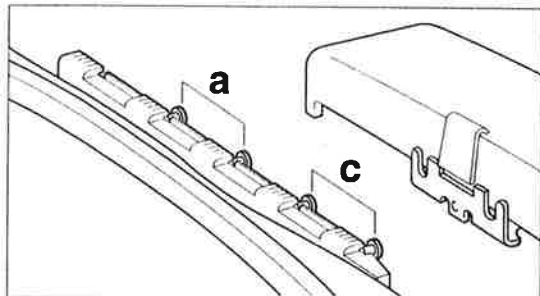

6. Move the frame to the place indicated by "c" and clamp it again with the carriage.

7. Embroider the next pattern. If using the same pattern, go straight ahead and start embroidering. If using a different pattern, select the new pattern. After touching "LAYOUT", touch "90° clockwise" to change the arrow in the display so that it points to the right. Then touch "START/CENTER" to set the current needle position as the embroidery start position.

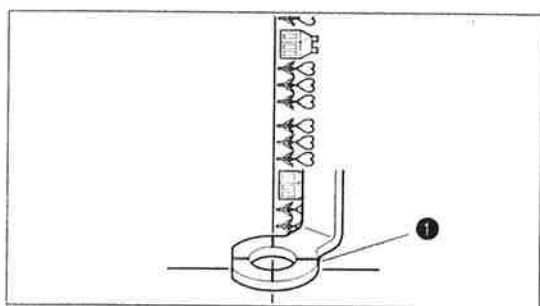

8. Use the arrow keys to move the needle to the previous embroidery end position, and then continue embroidering.

- ① Previous embroidery end